

AUTOMOTIVE LIFTS

2 Post Lifts

10,000 Lbs. F10 2 Post Lift

SKU 818779 FORF10I00MBL **2,599⁹⁹**

- Low Profile/Oversized Pads to Raise Most Vehicles
- 3 Stage Front Arms for Symmetric and Asymmetric Lifting
- Includes (4) 3.5" and 5" Adapter Extenders
- Warranty: 60 Days Labor, 18 Months Parts, 5 Years Structural

Price Does Not Include Installation or Optional Equipment as Shown.

FORWARD LIFT



10,000 Lbs. Dual Width Clearfloor 2 Post Lift

Symmetric SKU 210257 BENXPR10

2,999⁹⁹

Asymmetric SKU 210249 BENXPR10A

3,099⁹⁹

Low Profile Arm

SKU 557238 BENXPR10LP

3,099⁹⁹

Asymmetric Low Profile Arm

SKU 557237 BENXPR10ALP

3,099⁹⁹



Price Does Not Include Vehicles, Installation or Optional Equipment as Shown.

- Lifting Capacity: 10,000 Lbs.
- Rise: 69"
- Overall Height: 145"
- Overall Width: 132" - 145"

5-2-1 Warranty

Five Years (60-Months) Warranty on the lift structure

Two Years (24-Months) Warranty on the hydraulic cylinder(s) and power unit

One Year (12-Months) Warranty on operating components

One Year (12-Months) Labor Warranty on site or at factory

One Year (12-Months) Free-Shipping* on ground-freight charges related to warranty performance

*Free-shipping applies to direct shipping points within the 48 continental United States. Rural area shipping surcharge may apply for remote addresses. See BendPak.com for specific terms of warranty.

Challenger SA10 10,000 Lbs. Two Post Vehicle Lift

SKU 847098 CHLSA10 **2,899⁹⁹**

- Can Be Configured in Either the Symmetric or Asymmetric Position
- 3 Stage Front Arms Provide Greater Overall Arm Sweep
- Double Telescoping Screw Pads to Minimize the Need for Adapters

Price Does Not Include Vehicles, Installation or Optional Equipment as Shown.

CL Challenger Lifts



10,000 Lbs. 2 Post Lift

SKU 298485 CHLCL10V3 **4,199⁹⁹**

Versymmetric 3 Stage Arms

CL Challenger Lifts

Versymmetric Plus

DESIGNED TO LIFT ANYTHING FROM A COMPACT CAR TO A FULL SIZE TRUCK.

- Column Height: 11' 3"
- Adjustable Width Overall: 11' 6-1/2" / 11' 11"
- Floor to Overhead Switch: 134.5"
- Ceiling Height Required: 11' 11"
- Drive-Thru Clearance: 100" / 104-1/2"



Price Does Not Include Vehicles, Installation or Optional Equipment as Shown.

SAVE \$224⁹⁹

10K Truck Adapter Set

SKU 263557 | CHL10315

264⁹⁹

BUY THIS

GET THAT

224⁹⁹

Works with Challenger 10K Lifts Only

Offer Good Through June 30, 2016 - While Supplies Last

Frame Cradle Adapter Set

SKU 263785 | CHL10318

224⁹⁹

BUY THIS

GET THAT

224⁹⁹

Works with Challenger 10K Lifts Only

Offer Good Through June 30, 2016 - While Supplies Last

10,000 Lbs. 2 Post Lift

SKU 264325 CHLQ10 **2,599⁹⁹**

- Height Overall: 12' 3-1/2" or 11' 5-1/2"
- 3 Stage Front Arm and 2 Stage Rear Arms
- Lifts Symmetrically and Asymmetrically

BONUS Value: \$264.99

10K Truck Adapter Set

SKU 263557 | CHL10315

Value: \$264.99

with Purchase of:

10,000 Lbs. 2 Post Lift

SKU 264325 | Part# CHLQ10

Offer Good Through June 30, 2016 - While Supplies Last

QUALITY LIFTS

Price Does Not Include Vehicles, Installation or Optional Equipment as Shown.



Offer Good Through June 30, 2016 - While Supplies Last

10,000 Lbs. 2 Post Lift

SKU 499657 FORI10 **2,899⁹⁹**

- Low Profile 3-5/8" Min. Adapter Height
- Spot-Rite™ 3 Stage Front Arms for Symmetric and Asymmetric Lifting
- Overall Height: 143-3/8"
- Overall Floor Width: 137"
- Maximum Lifting Height: 76"
- Inside Column Width: 115"
- Drive Through Clearance: 105"
- Minimum Ceiling Height: 144"

Leasing Terms Available.†

Ask Your AutoZone® Commercial Sales Manager.

Free Delivery!

in 48 Continental United States

FORWARD LIFT



Price Does Not Include Vehicles, Installation or Optional Equipment as Shown.

10,000 Lbs. 2 Post Lifts

SKU 534581 ROTSPA10

4,299⁹⁹

Asymmetrical

SKU 210371 ROTSP010

4,299⁹⁹

Symmetrical

Rotary

- Surface Mounted, Frame Contact Lift
- Features Electric Hydraulic Operation and Genuine Symmetrical Design for Overhead Design for Clear Floor Lift
- Factory Rotated Columns Allow Doors of Vehicle to Be Fully Opened While Properly Positioned On Lift
- Arm Restraints On All Arms

Symmetrical Column Orientation

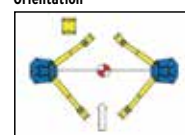

Asymmetrical Column Orientation

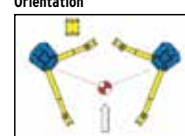

We Carry the Full Line of Rotary Lifts! Call 1-877-AZTool1 for Details.



Price Does Not Include Vehicles, Installation or Optional Equipment as Shown.

12,000 Lbs. F12N300 2 Post Lift

SKU 818751 FORF12N300BL **4,499⁹⁹**

- 2 Stage Arms Reach: 35" to 54"
- Accommodates Trucks and Many Cars
- Low Profile 4-3/4" Adapters
- Includes Four 3.5" and 5" Adapter Extenders
- Height Configurations of 11' - 10", 12'-10", and 14'-10" Are Available
- Warranty: 60 Days Labor, 18 Months Parts, 5 Years Structural

Leasing Terms Available.†

Ask Your AutoZone® Commercial Sales Manager.

Free Delivery!

in 48 Continental United States

FORWARD LIFT

NEW



Price Does Not Include Installation or Optional Equipment as Shown.

15,000 Lbs. Clearfloor, Standard Arms Lift

SKU 897976 BENXPR-15C **7,449⁹⁹**

- Lifting Capacity: 15,000 Lbs.
- Overall Height: 170"
- Overall Width: 155"
- Minimum Pad Height: 5"
- Rise: 69"
- Rise Time: 45 Seconds
- Motor: 220 VAC/1 Ph

(Truck Adapters Included)

Price Does Not Include Vehicles, Installation or Optional Equipment as Shown.

BendPak



Brigadier 10ACK 2 Post Lift

SKU 186433 DAN1375647 **2,799⁹⁹**

Asymmetric

- Lifting Capacity: 10,000 Lbs. / 4,546 Kg
- Overall Height: 145" / 3,683 mm
- Overall Width (Outside of Base Plates): 143-1/2"
- Overall Width (Outside of Columns): 136-1/2"
- Width Between Columns: 112-3/4"
- Minimum Reach (Front Arm): 25"/635 mm
- Maximum Reach (Front Arm): 46"/1,168 mm
- Minimum Reach (Rear Arm): 42"/1,067 mm
- Maximum Reach (Rear Arm): 60"/1,524 mm
- Minimum Pad Height: 4-1/2"/114 mm
- Rise: 69"/1,753 mm
- Maximum Lifting Height (Pad Only): 73"/1,854 mm
- Maximum Lifting Height (Pad and 6" Adapter): 79"/2,007 mm
- Drive Thru Clearance: 100-1/2"
- Motor: 220 VAC 60Hz. 1Ph

(Truck Adapters Included)

Dannmar EQUIPMENT



Price Does Not Include Vehicles, Installation or Optional Equipment as Shown.

Hofmann 10,000 Lbs. 2 Post Lift

SKU OUTSIDE BUY/EPO HOFEELR731A **2,999⁹⁹**

- Vehicles Can Be Positioned and Lifted Symmetrically or Asymmetrically
- Overall Height Can Be Adjusted 10"
- Power Column Can Be Arranged on Either the Driver or the Passenger Side
- Three Stage Front Arms Provide Superior Extended and Retracted Reach

Price Does Not Include Vehicles, Installation or Optional Equipment as Shown.

HOFMANN



BONUS Truck and Frame Cradle Adapters

Part# CHL10318 (Left) and CHL10315 (Right)

Value: \$489.98

with Purchase of:

12,000 Lbs. 2 Post Lift

SKU 264341 | Part# CHLQ12

Offer Good Through June 30, 2016 - While Supplies Last



12,000 Lbs. 2 Post Lift

SKU 264341 CHLQ12 **4,199⁹⁹**

- Height Overall: 14' 7" or 13' 10"
- Width Overall: 139-3/4"
- Drive Thru Clearance: 101"
- Rubber Door Protector Padded Overhead Safety Switch
- Floor to Overhead: 13' 3-1/2" or 14' 5"
- 2 Stage Front and Rear Arms for Symmetric Lifting

Price Does Not Include Vehicles, Installation or Optional Equipment as Shown.

QUALITY LIFTS



12,000 Lbs. Clearfloor Triple-Telescope Arms Lift

SKU 897974 BENXPR-12C **4,899⁹⁹**

- Triple-Telescope Arms-All Four to Easily Lift Your Largest Full-Size Pickups and Commercial Vehicles, Yet Still Provide Specific Capability for Sport and Compact Cars.
- Overall Height: 170"
- Overall Width: 155"
- Min Pad Height: 5"

Price Does Not Include Vehicles, Installation or Optional Equipment as Shown.

(Truck Adapters Included)

BendPak



18,000 Lbs. 2 Post Clearfloor, Standard Arms Lift

SKU 897977 BENXPR-18C **8,399⁹⁹**

- Overall Height: 170"
- Overall Width: 155"
- Min Pad Height: 5"
- Rise: 69"

Price Does Not Include Vehicles, Installation or Optional Equipment as Shown.

BendPak



Free Delivery!

in 48 Continental United States

Specifications Subject to Change Without Notice or Liability.

Prices Do Not Include Vehicles, Installation or Optional Equipment as Shown.

Customers Responsible for Off-loading Equipment Upon Arrival.

Ask Your Sales Rep for Details.

Leasing Terms Available.†

Ask Your AutoZone® Commercial Sales Manager.

Leasing Terms Available!†

Ask Your AutoZone®
Commercial Sales Manager

AutoZone®
Tool & Equipment QUARTERLY

2 Post Floor Plate Lifts

BendPak
[Truck Adapters Included]
Price Does Not Include Installation or Optional Equipment as Shown.



9,000 Lbs. 2 Post Lift Low Profile Arm
SKU 557232
BENXPR9LP **3,099⁹⁹**

- Low-Pro™ Arms that Accommodate Lowered Sports Cars and Those Vehicles with Lift Points Located On the Extreme Outer Edges of the Chassis
- Shorter Column for Low Ceiling Installations
- Column Height: 113"
- Extended Rise Gives You Over 6' of Under Clearance

BendPak
Price Does Not Include Vehicles, Installation or Optional Equipment as Shown.



[Truck Adapters Included]

9,000 Lbs. 2 Post Low Ceiling Lift
SKU 210379
BENXPR-9F **3,099⁹⁹**

- 9,000 Lbs. Lifting Capacity
- Short Column for Low Ceiling Installations
- Wide or Narrow Configuration
- Single Piece Columns
- Single Point Safety Release Drop End Arms Provide a Lower Pad Height

FORWARD LIFT
Low Ceilings Are No Problem!
Price Does Not Include Installation or Optional Equipment as Shown.



9,000 Lbs. 2 Post Lift
SKU 499660
FORBP9 **3,199⁹⁹**

- Minimum Ceiling Height: 113"
- Overall Width: 138-1/2" (3,518 mm)
- Overall Height: 111-1/4" (2,826 mm)
- Minimum Adapter Height: 3-1/2"
- Adapter Extenders Included
- ETL Certified

CL Challenger Lifts
Price Does Not Include Vehicles, Installation or Optional Equipment as Shown.



Challenger CLFP9 9,000 Lbs. Floor Plate 2 Post Lift
SKU 851779
CHLCLFP9 **3,399⁹⁹**

- 3 Stage Front and Rear Arms Provide Excellent Reach to Lift a Variety of Vehicles
- Drive-Thru Clearance: 98-3/16"
- Ceiling Height Required: 121-7/8"

CL Challenger Lifts
Price Does Not Include Vehicles, Installation or Optional Equipment as Shown.



12,000 Lbs. Floorplate Direct-Drive Lift
SKU 897973
BENXPR-12FD **4,779⁹⁹**

- Lifting Capacity: 12,000 Lbs.
- Overall Height: 170"
- Overall Width: 155"
- Minimum Pad Height: 5"
- Rise: 69"
- Rise Time: 45 Seconds

Quick Lifts: Rise Time 45 Seconds!

CL Challenger Lifts
NEW
CL10 Versymmetric 10,000 Lbs. 2 Post Dual Pendant Controls Quick Cycle Lift
SKU 851780
CHL10V3DPCQC **5,749⁹⁹**

- Quick Cycle Technology: Increased Rise of Speed to 27 Seconds from 48 Seconds Equating to a 42% Time Savings. Lowering Speed is Held to a Constant 17 Seconds (Approximately) Regardless of the Weight of the Vehicle.
- Up/Down Power Button + Dual Single Point Technical Lock Release System Provides Lift Operation from Either Column

CL Challenger Lifts
NEW
Express Solution CL10-XP9 10,000 Lb Quick Cycle 2 Post Pad Lift
SKU 851786
CHLCL10XP9QC **7,249⁹⁹**



Price Does Not Include Vehicles, Installation or Optional Equipment as Shown.

CL Challenger Lifts
NEW
CL10-XP9 Two Post Pad Lifts Come Standard with (4) 1-1/2" and (4) 3" Rubber Spotting Blocks and (4) Two Position Adapter Blocks

- Quick Cycle Technology Means 43% Faster Rise Time



Price Does Not Include Vehicles, Installation or Optional Equipment as Shown.

Storage Lifts

9,000 Lbs. Free Standing or Surface Mounted 4 Post Lift - Standard Height
SKU 264504
CHLQ4P09H **3,499⁹⁹**

- Rise Height to Top of Runway: 73-1/2"
- Outside to Outside Columns: 112"
- Overall Length (with Ramps Attached): 209"
- Inside Columns: 95"
- Height of Columns: 84-1/2"
- Width of Runways: 20"
- Height of Runways: 7"
- Width Between Runways: 38"
- Length of Runways: 164"



Price Does Not Include Vehicles, Installation or Optional Equipment as Shown.

Rolling Jacks Sold Separately.

Caster Set
SKU 264473
CHLQ4P09CS **229⁹⁹**



WORKS WELL WITH
4,500 Lbs. Hand/Hydraulic Operated Rolling Jack
SKU 264841
CHLQRJ04H **899⁹⁹**



(Optional Equipment)

BendPak
9,000 Lbs. 4 Post Lift
SKU 898142
BENHD-9 **2,999⁹⁹**

- Overall Width: 116-3/4" / 2,965 mm
- Overall Length: 200" / 5,080 mm
- Column Height: 88" / 2,235 mm
- Max. Lifting Height: 74-1/2" / 1,892 mm



Price Does Not Include Vehicles, Installation or Optional Equipment as Shown.

WORKS WELL WITH
RJ-45 4,500 Lbs. Capacity Rolling Bridge Jack
SKU 898534
BENRJ-45 **1,149⁹⁹**



(Optional Equipment)

FORWARD LIFT
8,000 Lbs. EFP8 Home Storage 4 Post Lift
SKU 818781
FOREFP8P000M **2,799⁹⁹**

- Perfect for Home Use
- Detachable Ramps Included
- Casters, Jack Tray, and Drip Trays Included
- Wired to Plug into 115V Receptacle

NEW
Price Does Not Include Vehicles, Installation or Optional Equipment as Shown.



WORKS WELL WITH
3,500 Lbs. RJ35BK Hand Pump Rolling Jack
SKU 818764
FORRJ35BK **699⁹⁹**



(Optional Equipment)

9,000 Lbs. 4 Post Home Storage / Light Duty Service Lift
SKU 383185
CHLQ4P07 **3,199⁹⁹**

- Rise Height Underneath Runway - 63"
- Outside to Outside Columns - 100"
- Overall Length (with Ramps) - 195 1/2" (w/o Ramps) 165"
- Inside Columns - 92"
- Height of Columns - 79 1/2"
- Width of Runways - 20"
- Height of Runway - 4"
- Width Between Runways - 38"
- Length of Runways - 150"
- Detachable Aluminum Approach Ramp Length - 36"
- 13 Lock Positions
- Pre-Assembled Lock Mechanism
- 1HP 110 Volt Plug-in or 220v Power*



Price Does Not Include Vehicles, Installation or Optional Equipment as Shown.

WORKS WELL WITH
4,500 Lbs. Hand/Hydraulic Operated Rolling Jack
SKU 383186
CHLQRJ03H **599⁹⁹**



(Optional Equipment)

BONUS Set of 3 Drip Trays
SKU 186439
Part# DAN101011
Value: \$69.99

with Purchase of:
Commander™ 7,000 Lbs. 4 Post Lift
SKU 186464
Part# DAN1375643

Offer Good Through June 30, 2016
While Supplies Last

Dannmar EQUIPMENT
Commander™ 7,000 Lbs. 4 Post Lift
SKU 186464
DAN1375643 **2,749⁹⁹**

- Spring-Loaded Safety Locks On Each Column
- Self-Lubricating UHMW Polyethylene Internal Slide Blocks
- Single Safety Lock Release Handle
- 7,000 Lbs. Capacity Free Standing Design
- Detachable Drive-Up Ramps Included



Price Does Not Include Vehicles, Installation or Optional Equipment as Shown.

Free Delivery! in 48 Continental United States | **Specifications Subject to Change Without Notice or Liability.** | **Customers Responsible for Off-loading Equipment Upon Arrival.** | **Leasing Terms Available.†** Ask Your Sales Rep for Details. | Ask Your AutoZone® Commercial Sales Manager.

AUTOMOTIVE LIFTS

4 Post Lifts

9,000 Lbs. 4 Post Lift
SKU 499672 **3,499⁹⁹**
FOREFP9

- Includes: Steel Approach Ramps, Jack Tray, Wheel Caster Kit and Drip Trays
- Single Point Lock Release
- Internal Lock System
- ETL Certified



Price Does Not Include Vehicles, Installation or Optional Equipment as Shown.

WORKS WELL WITH

4,500 Lbs. Rolling Jack
SKU 568432 **999⁹⁹**
FORRRJ45G



(Optional Equipment)

14,000 Lbs. 4 Post Lift
SKU 696483 **4,499⁹⁹**
FORCR14N100

- Heavy Duty Hydraulic Cylinder
- Single Point Latch Release System
- 78-3/4" Rise
- 18 Lock Positions
- Accommodates 182.5" Wheelbase Vehicles
- High Performance Cable and Sheave System
- ETL Certified - Model Shown is CR14N100



Price Does Not Include Installation or Optional Equipment as Shown.

WORKS WELL WITH

7,000 Lbs. Rolling Jack
SKU 568445 **1,999⁹⁹**
FORRRJ70G



(Optional Equipment)

2 Post Lift Accessories

Rubber 2 Post Lift Pad/ Slip Over/ Round - 1 Each

SKU 343396 **24⁹⁹**
BEN5715017

- Slip Over Rubber Lift Pad for Use with Bendpak 2 post Lifts with Round Flat Contact Pads. Sold Individually



Square Rubber Arm Pads (1 Each)

SKU 898880 **29⁹⁹**
BEN5715365

- Works with Any BendPak 2 Post Lift
- 5-5/8" Square
- 1-1/16" Thick

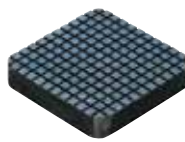

Frame Cradle Pad (1 Each)

SKU 466304 **49⁹⁹**
BEN5215506

- Perfect for Use with Any BendPak 2 Post Lift
- Tactile Rubber Mat Reduces Slippage and Protects Finish



Dannmar Frame Cradle Pad

SKU 289999 **44⁹⁹**
DAN119527



I10 2 Post Carriage Door Bumper Kit

SKU 568451 **59⁹⁹**
FORTPB10-D1

- Use with Forward FORI10



Round Rubber Lift Pad Assembly Drop-In (1 Each)

SKU 343397 **79⁹⁹**
BEN5215507

- Works with Any BendPak 2 Post Lift
- 1 Lift Pad
- 5" Diameter for Enhanced Stability
- Easy Drop-In Design



I10 Rubber Adapter Pad Kit

SKU 568440 **89⁹⁹**
FOR994105

- Use with Forward FORI10
- Eliminates Metal to Metal Contact at Vehicle Lift Points
- Includes (4) Pads and Attaching Hardware



I10 2 Post Lift Adjustable Adapters

SKU 568450 **299⁹⁹**
FORT100285

- Use with Forward FORI10
- Included Rubber Pad Eliminates Metal to Metal Contact
- Adapters Have Ears to Cradle Frames



Major D-12™ 12,000 Lbs. 4 Post Lift

SKU 343410 **3,999⁹⁹**
DAN1375681

- Single Hydraulic Cylinder Mounted Underneath Runway
- Internal "Anti-Sway" Slider Blocks in Each Column
- Features Heavy Duty 1/2" Aircraft Cable
- Oversized Self-Lubricating Cable Rollers
- Rugged 1-3/8" Roller Axles
- Multi-Position Safety Locks in Each Column
- Ramps Feature Non-Skid Surface Column
- Push-Button Safety Release
- Runways Adjust for Different Tread Widths

Price Does Not Include Vehicles, Installation or Optional Equipment as Shown.



WORKS WELL WITH

4 Post Rolling Bridge Jack DRJ-6

SKU 343411 **1,199⁹⁹**
DAN1375901

(Optional Equipment)



(Optional Equipment)

Challenger 4P14 14,000 Lbs. 4 Post Lift

SKU 851781 **5,599⁹⁹**
CHL4P14EFX

- Louvered Approach Ramps for Positive Vehicle Traction
- Adjustable Runways to Accommodate a Variety of Tread Widths
- Column Height* 90 1/2"
- Minimum Bay Size: 12' x 24'

Price Does Not Include Vehicles, Installation or Optional Equipment as Shown.



WORKS WELL WITH

7.7K Rolling JK

SKU 264847 **2,299⁹⁹**
CHLRJ75

(Optional Equipment)



(Optional Equipment)

14,000 Lbs. 4 Post Lift

SKU 898152 **4,299⁹⁹**
BENHDS14

- Overall Width: 130"
- Overall Length: 241"
- Max. Rise: 70"
- Motor: 220 VAC/1 Ph



Price Does Not Include Vehicles, Installation or Optional Equipment as Shown.

WORKS WELL WITH

(Shown with Optional Equipment)

RJ-7 7,000 Lbs. Capacity Rolling Bridge Jack

SKU 212556 **1,269⁹⁹**
BENRJ-7

(Optional Equipment)



(Optional Equipment)

18,000 Lbs. 4 Post General Service Lift

SKU 568426 **8,099⁹⁹**
FORCR18

- Max. Wheelbase: 194"
- Durable Cable and Sheave System
- ETL Certified to ANSI/ALI ALCTV: 2011



18,000 Lbs. Long Wheelbase 4 Post Lift

SKU 568427 **8,849⁹⁹**
FORCR18LW

- Max. Wheelbase: 230"

Price Does Not Include Vehicles, Installation or Optional Equipment as Shown.

WORKS WELL WITH

9,000 Lbs. Rolling Jack

SKU 568446 **2,999⁹⁹**
FORRJ901000

(Optional Equipment)



(Optional Equipment)

Don't Let the Tire Make You Tired!

Omega Wheel Arm™

SKU 573207 **149⁹⁹**
OMG92100

- Holds the Tire at Lift Arm Height and is Handy with Tire Rotations and Brake Jobs
- Easy and Safe for Mechanics to Put On or Take Off Tires
- Avoid Bending Over to Put Down or Pick Up a Tire
- Fits Most Lift Arms 3" - 5" Wide
- Set Includes (2) Wheel Arms and (2) Magnetic Tool Trays



Price Does Not Include Tires or Rims as Shown.

INCLUDES:
2 Round Magnetic Trays

Set of 2

\$19⁹⁹ Value



4 Post Lift Accessories

2 Drip Trays

SKU 301768 **69⁹⁹**
BEN5700301



Caster Wheel Set

SKU 898905 **299⁹⁹**
BEN5210997

- For Use On HD-9 Series Lift Only

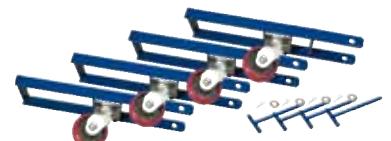

Rolling Oil Drain

SKU 898714 **379⁹⁹**
BENDP-30

- Adjustable Width: 33" - 60"



Free Delivery!
in 48 Continental United States

Specifications Subject to Change Without Notice or Liability.
Prices Do Not Include Vehicles, Installation or Optional Equipment as Shown.

Customers Responsible for Off-loading Equipment Upon Arrival.
Ask Your Sales Rep for Details.

Leasing Terms Available!
Ask Your AutoZone® Commercial Sales Manager.

Leasing Terms Available!†

Ask Your AutoZone®
Commercial Sales Manager

AutoZone®
Tool & Equipment QUARTERLY

TUXEDO
Distributors, LLC.
Automotive Equipment & Accessories

Tuxedo Distributors, LLC, is a leading importer of high quality automotive repair equipment offering a full line of automotive equipment at an economical price. With our 15 satellite warehouses strategically located across the US, we offer an unparalleled competitive advantage.

Approved Outside Buy Vendor

Call to place order!

817.558.9337

877.558.9337 Toll Free

TWO POST LIFTS

TLT240SC
9,000lbs CAPACITY **2,099⁹⁹**

TLT240SB
9,000lbs CAPACITY **1,999⁹⁹**

- 9,000 lb. lifting capacity
- Overall Height: 151" (TLT240SC)
- Overall Width: Symm 134", Asymm 140" (TLT240SC)
- Overall Height: 113" (TLT240SB)
- Overall Width: 133" (TLT240SB)
- Rubber Door Guards
- Hose Guards
- Dual Point Lock Release
- Heavy-Duty Arm Restraint System
- Double Telescoping Screw Pads
- Adjustable Column Width (TLT240SC)
- Standard or Rotated Asymmetric Columns (TLT240SC)

LAUNCH



TP9KAC
9,000lbs CAPACITY **1,949⁹⁹**

TP9KF
9,000lbs CAPACITY **1,949⁹⁹**

- 9,000 lb. lifting capacity
- Overall Height: 142" (TP9KAC)
- Overall Width: 141" (TP9KAC)
- Overall Height: 111-1/2" (TP9KF)
- Overall Width: 141" (TP9KF)
- Chain Driven
- Dual cylinders with low friction chain rollers
- Low profile arms
- 1-1/2" and 5" stackable drop-in height adapters
- Automatic safety cut-off bar (TP9KAC)
- Mounting Hardware included
- Powder-Coated Finish



TLT210-XT
10,000lbs CAPACITY **2,799⁹⁹**

- 10,000 lb. lifting capacity
- Overall Height: 149"
- Overall Width: Symm 137", Asymm 138"
- Heavy-Duty Arm Restraint System
- Adjustable Column Height
- Adjustable Column Width
- Outer Hose Guards
- Stackable Foot Pad Extensions two 6" and two 3"
- 3 Stage Front Arms
- Rubber Door Guards
- Single Point Lock Release
- Standard or Rotated Asymmetric Arm Configuration
- Double Telescoping Screw Pads offering 6.5" adjustment for complete vehicle coverage

LAUNCH TECH USA



Standard Asymmetric Arm Configuration



Rotated Asymmetric Arm Configuration

TP11KC-DX
11,000lbs CAPACITY **2,799⁹⁹**

- 11,000 lb. lifting capacity
- Direct Drive Cylinders
- Overall Height: 145"
- Overall Width: 145-1/2"
- 3 Stage Front Arms, Low Profile Arms
- Asymmetric/ Symmetric Arm Configuration
- Symmetric Columns
- Single Point Lock Release
- Rubber Door Guards
- Mounting Hardware included
- Spin Up Pads with 2" and 4" stackable drop in Truck Adapters
- Powder-Coated Finish



BI-SYMMETRIC™ DESIGN
Asymmetric/Symmetric arm configuration with 180 degree front arm rotation.

SERVICE LIFT

FP14K-C
14,000lbs CAPACITY **4,999⁹⁹**
Service Lift

- 14,000 lb. lifting capacity
- Overall Height: 68-7/8"
- Overall Width: 136-3/4"
- Overall Length: 250-1/2"
- Cable Driven
- Closed Front
- Single point pneumatic safety release
- 20" wide non-skid, diamond plate runways
- Mounting Hardware included
- Powder-Coated Finish

Also sold as an Alignment Lift



BRIDGE JACK

RAJ-8K
8,000lbs CAPACITY **1,599⁹⁹**

- Universal Roller Body Design w/dual 'spring loaded' precision roller bearing and Side Guide Wheels w/adjustable Height for Low, Medium, and High Jack Rail Configurations
- Rolls on top edge of Jack Rail for smooth maneuverability
- Dual Height Telescoping Support Arms
- Pneumatic operation w/adjustable Pressure Regulator
- Stackable Pad and Height Adapters 1 5/16" and 5" (1 Pair each)
- Dual Air Bags



STORAGE LIFT

FP8K-DS
8,000lbs CAPACITY **2,599⁹⁹**

- 8,000 lb. capacity
- Overall Height: 86-1/4"
- Overall Weight: 103-1/2"
- Overall Length: 207-1/8"
- Ladder lock safety system with "auto engage" locking bar
- Extra-large slider blocks for added stability
- 10 Lock Positions
- Aircraft quality cables
- Single Point Lock Release
- 18" Wide non-skid, diamond plate runways
- Casters, Jack Tray, and Approach Ramps included

IDEAL



WHEEL SERVICE

TC-530
Semi-Automatic Tire Changer **1,599⁹⁹**

- Internal Clamping Capacity: 12" - 23"
- External Clamping Capacity: 10" - 20"
- Max Wheel Diameter: 38"
- Wheel Width: 3" - 12"
- Swing arm design
- Bead seating inflation jets are integrated in the clamping jaws
- Side mounted Bead Breaker



TC-950
Semi-Automatic Tire Changer **1,699⁹⁹**

TC-950-WPA
High Performance Tire Changer with Press Arm **2,699⁹⁹**

- Internal Clamping Capacity: 15" - 28"
- External Clamping Capacity: 13" - 24"
- Max Wheel Diameter: 47"
- Wheel Width: 3" - 15"
- Swing arm design
- Bead seating inflation jets are integrated in the clamping jaws
- Twin clamping cylinders provide more power to hold the most difficult rims
- Conveniently located and powerful bead breaker
- Large diameter hex mount/demount shaft for extra rigidity
- Left side press arm (WPA)
- Ideal for low profile tires (WPA)
- No scratching, machine never contacts rim (WPA)



WB-953
High Performance Wheel Balancer **1,249⁹⁹**

- Max Wheel Diameter: 39"
- Rim Width: 1.5" - 20"
- Rim Diameter: 10" - 24"
- Wheel Weight Capacity: 150 lbs
- Self-calibrating; Self-diagnosis
- Optimization program
- Static balancing
- Three centering cones
- Hood, hammer, speed nut and caliper come standard
- Optional motorcycle adapter is available



WB-448
Heavy Duty Truck Wheel Balancer **2,499⁹⁹**

- Max Wheel Diameter: 47"
- Rim Width: 1.5" - 20"
- Rim Diameter: 10" - 24"
- Wheel Weight Capacity: 298 lbs
- Self-calibrating; Self-diagnosis
- Pneumatic Wheel lift included
- Foot brake for manual stop
- Capable of balancing a full range of wheels
- Car and Truck cones come standard



AUTOMOTIVE LIFTS

Lift Accessories



Air/Electric Workstation for 4 Post Lifts

SKU 263294
CHL10310

359⁹⁹

- Convenient Power Source for Extension Lights and Other Tools
- Air Supply Will Always Be at Arms Reach for Facilities Using Pneumatic Tools Such As Impact Wrenches



Air/Electric Workstation

SKU 898684
BENWSA-100

349⁹⁹

- Adds Air and Electric Capabilities to Any BendPak Lift Simple, Safe and Extremely Easy-to-Use
- (4) 110V GFI Outlets, Oiler, Air Supply, Pressure Gauge, Storage Hooks for Hose and Tools, Regulator/Filter, Air Inlet
- Fits 2 or 4 Post Lifts

You Will Need to Know BendPak Lift Model # When Ordering



Air/Electric Workstation

SKU 568448
FOR991359

369⁹⁹

- Use with Forward FOR110
- Air/Electric Workstation with Air Regulator and Oiler



Mid-Rise Lifts



BL3500 Quick Jack

SKU 463773
RAN5175185

- Position Jack Frames Under the Vehicle, Push Button On the Remote and in Less than Ten Seconds the Entire Car is Almost Two Feet Off the Ground
- A 110V AC Power Unit Comes Standard
- Optional DC Power Unit is Also Available
- Weight Capacity: 3,500 Lbs.



Price Does Not Include Installation or Optional Equipment as Shown.

BL5000 Quick Jack

SKU 565128
RAN5175188

1,299⁹⁹

- Open Center Design for Clear Undercar Access
- Remote Pendant Control Features a 20' Cord
- Includes an 8 Piece Set of Adjustable and Stackable Rubber Lift Blocks
- Platform Lifting Height (with Rubber Lift Blocks): 22" / 559 mm



Price Does Not Include Vehicles, Installation or Optional Equipment as Shown.



6000XL Mid-Rise Scissor Lift

SKU 555446
DAN1375652

1,899⁹⁹

- For Servicing Light-Duty Cars and Trucks
- Portable Motor Cart Serves as Tow Handle
- Adjustable Arm Assemblies
- Safety Bar with Multiple Lock Positions



SCAN FOR DETAILS



Price Does Not Include Vehicles, Installation or Optional Equipment as Shown.

Lift Gate Service
SKU 262534
DANLIFTGATE **100⁰⁰**

6,000 Lbs. Mid-Rise Lift

SKU 499655
FOR6000MRL

2,049⁹⁹

- Width: 41"
- Rise: 52"
- Multiple Locking Positions
- Truck Adapters Included



Price Does Not Include Vehicles, Installation or Optional Equipment as Shown.

Lift Gate Service
SKU 626137
FORLIFTGATE **95⁰⁰**

6,000 Lbs. Portable Mid-Rise Lift

SKU 210386
BENMD-6XP

2,049⁹⁹

- Portable, Easy to Move from Bay-to-Bay
- Adjustable Arms
- Lifting Capacity: 6,000 Lbs.



Truck Adapters Included

Power Unit Plugs into 110v Outlet

Lift Gate Service
SKU 262533
RANLIFTGATE **135⁰⁰**

Price Does Not Include Installation or Optional Equipment as Shown.

BONUS

Rolling Work Seat
SKU 752040 | Part# DAN106625

Value: **\$49.99**



with Purchase of:
MaxJax 6,000 Lbs. Portable 2 Post Lift
SKU 186434 | Part# DAN1375659

Offer Good Through June 30, 2016 • While Supplies Last

MaxJax 6,000 Lbs. Portable 2 Post Lift

SKU 186434
DAN1375659

2,299⁹⁹

- Perfect for Low Clearance Ceilings and Home Garages
- Built-In Wheels that Allow You to Store It Out of the Way When Not in Use
- Max. Lift Height (with 3" Adapter): 52"

Lift Gate Service
SKU 262534
DANLIFTGATE **100⁰⁰**



Price Does Not Include Vehicles, Installation or Optional Equipment as Shown.

Dannmar EQUIPMENT

Low-Rise Lifts



6,000 Lbs. Low-Rise Pad Lift

SKU 210383
BENLR-60

1,669⁹⁹

- Max. Height: 26"
- Overall Width: 70"
- Overall Length: 82"

Lift Gate Service
SKU 262533
RANLIFTGATE **135⁰⁰**



Price Does Not Include Vehicles, Installation or Optional Equipment as Shown.

Portable

SKU 210384
BENLR-60P

1,749⁹⁹

- Max. Height: 26"
- Overall Width: 70-1/2"
- Overall Length: 82"

7,000 Lbs. Low-Rise Pad Lift

SKU 568436
FORTL07

2,349⁹⁹

- Wired to Plug into 115V Receptacle
- Max. Rise: 24-3/4"

Lift Gate Service
SKU 626137
FORLIFTGATE **95⁰⁰**



Price Does Not Include Installation or Optional Equipment as Shown.

10,000 Lbs. Low-Rise Pad Lift

SKU 479989
BENLR-5T

2,649⁹⁹

- Max. Height: 23" - 32"
- Lowered Height: 4"
- Lift Blocks Included

Lift Gate Service
SKU 262533
RANLIFTGATE **135⁰⁰**



Price Does Not Include Installation or Optional Equipment as Shown.

Motorcycle Lifts



Motorcycle Jack

SKU 568452
FORBJ10

199⁹⁹

- Use With Forward FOR100MCL



1,000 Lbs. Air Operated Motorcycle Lift

SKU 499659
FOR100MCL

1,049⁹⁹

- Includes Wheel Vise and Two 12' Extensions, Making it Great for Motorcycles, ATVs, Lawn Mowers, Golf Carts, Etc.
- Rise: 33", Length 93", Width 24", Width With ATV Adapters 48"

Lift Gate Service
SKU 626137
FORLIFTGATE **95⁰⁰**



Price Does Not Include Vehicles, Installation or Optional Equipment as Shown.

1,000 Lbs. Droptail Motorcycle Lift

SKU 568439
FOR100MCLDT

1,249⁹⁹

- FORBJ10 Included
- Rise 33" Length 93", Width 24"

Lift Gate Service
SKU 626137
FORLIFTGATE **95⁰⁰**



Price Does Not Include Vehicles, Installation or Optional Equipment as Shown.

Motorcycle Lift

SKU 626120
RANRML-1500XL

1,449⁹⁹

- Lifting Capacity: 1,500 Lbs. / 682 kg
- Power Supply: Air/Hydraulic
- Main Platform Length: 89" / 2,286 mm
- Main Platform Length with Front Extension: 102" / 2,591 mm
- Main Platform Width: 30" / 762 mm

Lift Gate Service
SKU 262533
RANLIFTGATE **135⁰⁰**



Price Does Not Include Vehicles, Installation or Optional Equipment as Shown.

Free Delivery!
in 48 Continental United States

Specifications Subject to Change Without Notice or Liability. Customers Responsible for Off-loading Equipment Upon Arrival.
Prices Do Not Include Vehicles, Installation or Optional Equipment as Shown.

Leasing Terms Available.[†]
Ask Your Sales Rep for Details.

Ask Your AutoZone[®] Commercial Sales Manager.

Leasing Terms Available!†

Ask Your AutoZone®
Commercial Sales Manager

AutoZone®
Tool & Equipment QUARTERLY

CL10 Series Lifts

**Versymmetric®
plus**

**CL10 Versymmetric
10,000 Lbs. 2 Post Lift**

SKU 298485
CHVCL10V3 **4,199⁹⁹**

- Exclusive Versymmetric® Technology Provides a Versatile 2 Lifts In One™ Design to Safely Lift Vehicles Symmetrically or Asymmetrically Within the Same Service Bay
- Standard Offset Arm Design Provides Directspot™ to Vehicle's Front Lifting Points for Built-In Productivity
- Double Telescoping Screw Pads Adjust from 4-7/8" to 6-3/8" Reducing the Need for Adapters
- Rubber Door Guards Protect Vehicles from Door Damage When Accessing Driver Controls
- 11' 8" Standard Height Allows Lift To Be Placed In Standard Service Bay with 12' Ceiling
- Heavy-Duty 5" Diameter Pulley and 5/16" Cable Reduces Stress On Equalization System and Increases Cable Life
- Available 2' and 3' Column Extensions Enable Technician to Work at an Ergonomic Height When Servicing Taller Vehicles



Price Does Not Include Vehicles, Installation or Optional Equipment as Shown.

CL Challenger Lifts

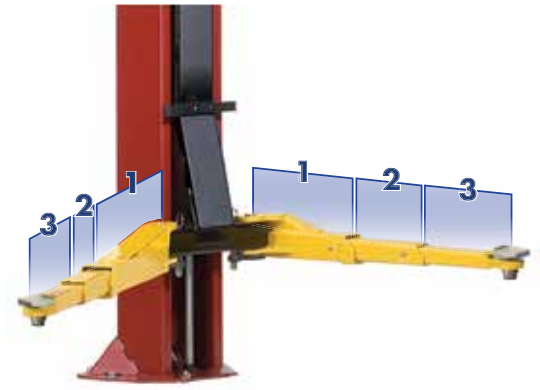

Arm Configurations

- › Industry First Two Post Lift with **directSPOT™** Offset 3 Stage Front Arms Plus 3 Stage Rear Arms for Single Sweep Spotting - Eliminates the Need of Rolling Vehicles Back and Forth to Swing Front Arm Clear of Front Tire
- › Maximum Arm Sweep, Reach and Retraction Meets the Widest Range of Recommended Lifting Points

Express Service Lifts

**Versymmetric®
plus**

**CL10 Versymmetric
10,000 Lbs. 2 Post Dual
Pendant Controls Lift**

SKU 851785
CHLCL10V3-DPC **5,199⁹⁹**

- Offset Front Arm Provides Directspot™ Single Sweep Spotting - No Rolling Vehicles Back and Forth to Swing Front Arm Clear of Front Tire
- Dual Pendant Power Controls Expedites Vehicle Spotting by Providing an Unobstructed View to Lifting Points



Price Does Not Include Vehicles, Installation or Optional Equipment as Shown.

**CL10-XP9 9,000 Lb.
Dual Pendant Controls
2 Post Pad Lift**

SKU 851786
CHLCL10XP9DPC **7,249⁹⁹**

- CL10-XP9 Two Post Pad Lifts Come Standard with (4) 1-1/2" and (4) 3" Rubber Spotting Blocks and (4) Two Position Adapter Blocks
- Dual Pendant Power Controls Expedites Vehicle Spotting by Providing an Unobstructed View to Lifting Points



Price Does Not Include Vehicles, Installation or Optional Equipment as Shown.

DESIGNED TO LIFT ALL OF TODAY'S LOWER PROFILE PERFORMANCE CARS AND SMALLER FRAME CARS IN MIND.

Drive-On Style Two Post Lift Featuring Flip-Up Ramps Perfect For Express Service Quick Lube Applications, Tire Rotations, Tire Balancing, Brake Work, Inspection Check Lanes and Other General Service

**Versymmetric®
plus**

**CL10 Versymmetric
10,000 Lbs. 2 Post Dual
Pendant Controls
Quick Cycle Lift**

SKU 851780
CHL10V3DPCQC **5,749⁹⁹**

- Quick Cycle Technology: Increased Rise of Speed to 27 Seconds from 48 Seconds Equating to a 42% Time Savings. Lowering Speed is Held to a Constant 17 Seconds (Approximately) Regardless of the Weight of the Vehicle.
- Up/Down Power Button + Dual Single Point Technical Lock Release System Provides Lift Operation from Either Column



Price Does Not Include Vehicles, Installation or Optional Equipment as Shown.



**CL10-XP9 9,000 Lbs. Quick
Cycle 2 Post Pad Lift**

SKU 851783
CHLCL10XP9QC **7,249⁹⁹**

- CL10-XP9 Two Post Pad Lifts Come Standard with (4) 1-1/2" and (4) 3" Rubber Spotting Blocks and (4) Two Position Adapter Blocks
- Quick Cycle Technology Means 43% Faster Rise Time

Our Quick Vehicle Spotting Solution Is Perfect for Express Service Requirements Such As Quick Lube Applications, Tire Rotations, Tire Balancing, Brake Work, Inspection Check Lanes and Any Other General Service Need Where Productivity Is Essential.



Price Does Not Include Vehicles, Installation or Optional Equipment as Shown.

SA10 Lift

**SA10 10,000 Lbs.
2 Post Vehicle Lift**

SKU 847098
CHLSA10 **2,899⁹⁹**

- Can be Configured in Either the Symmetric or Asymmetric Position
- 3 Stage Front Arms Provide Greater Overall Arm Sweep
- Double Telescoping Screw Pads to Minimize the Need for Adapters

Optional 2' Column Height Extensions Accommodate Higher Profile Vehicles. Includes (2) Height Extensions, Hose Extension Kit and New Cables.



Price Does Not Include Vehicles, Installation or Optional Equipment as Shown.

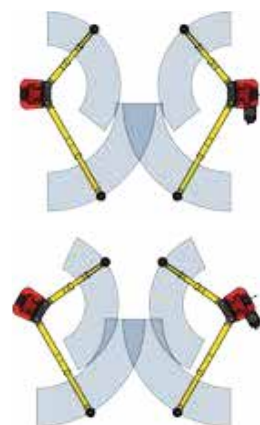

Arm Coverage

Symmetrical Configuration
3-Stage front and 2-Stage rear arms.

Asymmetrical Configuration
3-Stage front and 2-Stage rear arms.

Challenger Lifts' SA10 features the ability to be configured in either the symmetric or asymmetric position dependant upon the service requirements of your shop. The SA10 features 3 stage front arms that provide maximum extension and retraction ensuring safe and reliable lifting on all vehicles within rated capacity.

With adjustable height and width options, double telescoping screw pads, durable powder coat finish, plated arm restraints and pins and many other appealing features, the SA10 will accommodate the rigorous demands of a full service facility. Available in red and blue.