

AutoZone®

Tool & Equipment QUARTERLY



Contact Us:
1-877-AZTool1 Phone
 (1-877-298-6651) *Hablamos Español*

July, August and September 2016

Cool-Tech R134a Recovery, Recycling and Recharging Machine

SKU 221185 **2,899⁹⁹**
 ROB34288

- Combines Simple Operation with Superior Accuracy
- Automatic Air Purge: Eliminates Damaging Air without Monitoring Gauges or Opening Valves
- Refrigerant Management System: Displays Refrigerant Use and Monitors Remaining Filter Life



ROBINAIR

Refrigerant Charging: Select a Charge Mode from High or Low Side, or Use Both Sides

SKU 751572 **3,899⁹⁹**
 ROB34788NI-H

- Fully Automatic Function: Program to Recover, Vacuum, Leak Test and Charge without Operating Panel Valves
- Save and Print Before and After Service Data: Allows the User to Store Before and After Service Information By Vehicle and Print this Information to Provide to a Customer
- Visual and Audible Alarm: Notifies the User When Service Is Complete, or If a Problem Has Occurred



ROBINAIR

Premium Refrigerant Recovery, Recycling and Recharging Machine

SKU 249512 **4,199⁹⁹**
 ROB34988

- The 34988 Recovers, Recycles, Evacuates, Leak Tests and Recharges R134a Quickly and Accurately
- SAE J2788 Compliant
- Fully Automatic Function: Program to Recover, Vacuum, Leak Test and Charge without Operating Panel Valves
- Automatic Dye Inject: Gives the User the Ability to Use the Machine to Inject UV Dye into a Vehicle's A/C System



ROBINAIR

1234YF Recover, Recycle, Recharge Machine

SKU 751575 **6,399⁹⁹**
 ROBAC1234-6

- Fully Automatic Operation — Program For Service, Walk Away and Return When Complete
- On-Board Printer Capable of Printing Vehicle Service Report Slips to Present to Customers
- Integrated Refrigerant Identifier (Meets SAE J2927)



ROBINAIR

MORE RECOVERY MACHINES IN AIR CONDITIONING, PAGES 26-33 >>>

Recover and Recharge

MORE RECOVERY MACHINES IN AIR CONDITIONING, PAGES 26-33 >>>

MORE WHEEL SERVICE COMBOS IN TIRE SERVICE, PAGES 34-39 >>>

Combos

MORE LIFT COMBOS IN ALIGNMENT LIFTS, PAGES 46-49 >>>

Price Does Not Include Tires or Rims as Shown.

Combo with geodyna® 7100 Balancer and monty1520 Tire Changer

SKU 079535 **5,899⁹⁹**
 HOFCOMB04

- Includes: Hofmann geodyna 7100 Car Wheel Balancer with LED Display and HOFM1520110 monty1520 20" Capacity Tire Changer



HOFMANN



Price Does Not Include Tires or Rims as Shown.

geoliner™ 670XD Aligner Combo with 14,000 Lbs. Lift

SKU OUTSIDE BUY/EPO **36,999⁹⁹**
 ALIGNCOMB05

- Combining The 670XD Imaging Wheel Alignment System Along with the Forward CRA14 14,000 Lbs. 4 Post Alignment Lift Gets You Both the Latest Technology and Proven Durability
- Hofmann Aligner Includes Setup and Training



Available via Outside Buy/EPO, Call (1-877-298-6651) for details.

FORWARD LIFT

HOFMANN

10,000 Lbs. 2 Post Lift - Low Profile Arm

SKU 557237 **3,099⁹⁹**
 BENXPR10ALP

- Low-Pro™ Arms Accommodate Lowered Sports Cars and Those Vehicles with Lift Points Located on Outer Edges of the Chassis
- Asymmetric Model 30° Rotated Single-Piece Columns
- Truck and Van Adapters Standard



Price Does Not Include Vehicles, Installation or Optional Equipment as Shown.

MORE LIFTS IN AUTOMOTIVE LIFTS, PAGES 40-45 >>>

Ford Timing Chain Locking Wedge Tool

SKU 012647 **19⁹⁹**
 24207

- For 2005-14 5.4L and 4.6L 3V
- OE Type Tool

Ford Cam Phaser Noise Repair Kit

SKU 079897 **699⁹⁹**
 24206

- Adding this Kit to a 4.6/5.4L 3V Car, Truck, or SUV Will Help Ensure that Your Cam Phasers Don't Suffer Premature Failure
- One Kit Corrects Both Cam Phasers



Cam Phaser Is NOT INCLUDED

MORE TOOLS IN ENGINE SERVICES, PAGES 84-85 >>>

READY TO RIDE

Avoid the traditional hassles of Power Sports battery handling, preparation, and installation.

- EASY** Factory Charged
- SAFE** Won't spill, no adding acid
- FUN** Enjoy maximum power

Patented heavy-duty top and side connection terminals



MORE INFO ON PAGE 81 >>>

MORE FANS IN SHOP EQUIPMENT, PAGE 14 >>>

Cool Down With OEM TOOLS®

20" Floor Fan

SKU 688200 **59⁹⁹**
 24870

- 20" High Velocity Floor Fan
- Energy Efficient 3 Speed Motor



Portable Mechanic's Fan - 1200 CFM

SKU 850066 **89⁹⁹**
 24878

- For Indoor or Outdoor Use
- Great for Use in Shops, Offices, Homes and Other Locations
- 4 Position Feet • 3 Speed Switch



Portable Mechanic's Fan - 300 CFM

SKU 850064 **69⁹⁹**
 24877



20" Internal Orbit Fan

SKU 688199 **99⁹⁹**
 24872

- 20" Orbital Fan
- 3 Speed High Efficient Motor



20" Oscillating Pedestal Fan

SKU 688197 **119⁹⁹**
 24871

- 20" Pedestal Fan
- Oscillating 3 Speed Motor



24" Barrel Tilt Fan

SKU 688216 **159⁹⁹**
 24874

- 24" Tilting Drum Fan
- 2 Speed High Efficient Motor



30" Pedestal Fan

SKU 688201 **199⁹⁹**
 24873

- 30" Pedestal Fan
- 3 Speed High Efficient Motor



36" Barrel Tilt Fan

SKU 688217 **279⁹⁹**
 24875

- 36" Tilting Barrel Fan
- 2 Speed High Efficient Motor



42" Belt Driven Barrel Fan

SKU 688203 **379⁹⁹**
 24876

- Versatile 42" Barrel Fan
- 2 Speed Belt Driven Motor

BONUS

70 Piece Impact Drill-Driver Bit Set
 SKU 847085 | Parts MAKTO1725

VALUE: \$34.99



with Purchase of:

12V Impact Driver Kit
 SKU 010106 | Parts MAKTO3R1

12V Impact Driver Kit

SKU 010106 **149⁹⁹**
 MAKTO3R1

- Delivers 970 In./Lbs. of Torque
- Built-In LED Light



Offer Good Through September 30, 2016
 While Supplies Last

WE'RE HERE TO HELP

DID YOU KNOW?

A BUSINESS CAN TAKE ADVANTAGE OF IRS S-179 TAX CREDITS ON EQUIPMENT PURCHASES.

CONTACT YOUR CPA FOR DETAILS.

What is the S-179 Tax Credit?

Section 179 of the IRS tax code allows businesses to deduct the full purchase price of qualifying equipment and/or software purchased or financed during the tax year. That means that if you buy (or lease) a piece of qualifying equipment, you can deduct the FULL PURCHASE PRICE from your gross income. It's an incentive created by the U.S. government to encourage businesses to buy equipment and invest in themselves. (Retrieved from http://www.section179.org/section_179_deduction.html)

PURCHASING PROGRAMS



Ask Us About Our Tool and Equipment Purchase Programs



OPTION 1 LEASING COMPANY

Leases are Handled by Three Companies



Customer Must:

- Select Equipment
- Complete Credit Application
- Approval Received from Leasing Company

Once the Transaction is Approved

- PO Issued
- Tool Ordered



OPTION 2 30-60-90

✓ AutoZone® Credit Account in Existence for 6 Months

✓ Updated Credit Application with Agreement Section Completed and Signed

✓ No NSF Checks

✓ No Credit Holds 6 Months

✓ Credit Worthiness

✓ Minimum Equipment Cost • \$1K (Tax Must be Included)

✓ 25% Minimum Down Payment

✓ 52 Week Sales Amount \$15K



OPTION 3 EXTENDED TERMS

✓ 3 Years in Business (Credit Bureau Reporting)

✓ Updated Credit Application with Agreement Section Completed and Signed

✓ No NSF Checks for 1 Year

✓ 1 Year Satisfactory Payment History with AutoZone®

✓ Credit Worthiness

✓ Minimum Equipment Cost by Term

- 6 Months \$3K
- 9 Months \$6K
- 12 Months \$8K or greater

✓ 25% Minimum Down Payment

✓ Financial Statement

✓ 52 Week Sales Amount \$25K

Financing is provided by third parties who are not affiliates of AutoZone. All of the advertised loan programs, rates, terms and conditions are subject to change at any time without notice. An extra charge may be imposed at the end of the lease depending on the residual value of the leased goods.

CUSTOMER SERVICE



Our Customer Service Associates Have Over 100 Years of Combined Experience in the Tool and Equipment Industry.

You can be sure they are ready to answer your questions and give you the support you need to manage your business and keep your customers satisfied.



We want your purchasing experience to be the best and make sure you are satisfied. As our customer, you can expect fast, personalized and professional service.

For All of Your Tool, Equipment and Shop Supply Needs, Call **1-877-AZTOOL1 (1-877-298-6651)** or Email Us at **AZTOOL@AZTOOL1.com**. (Hablamos Español)

Call Center Hous: Monday - Friday 7:00 a.m. to 5:00 p.m. CST

Guiding You to the Right Products at the Right Price:

"What is the Right Tire Changer for My Shop?"

Call
1-877-AZTool1

"I'm Looking for a Specific Item That's Not in This Flyer."

Call
1-877-AZTool1

"Can You Track Down My Order?"

Call
1-877-AZTool1

"I'm Interested in Leasing Some Equipment."

Call
1-877-AZTool1

"I Need My 4 Post Lift Repaired."

Call
1-877-AZTool1

"I HAVE A PROBLEM!!!"

Call
1-877-AZTool1

Double Insulated Tumblers

OEMTOOLS Tumblers® 10 Oz., 20 Oz., and 30 Oz.

- Made with Durable Kitchen-Grade 18/8 Stainless Steel
- Double-wall Vacuum
- Insulation Keeps Drinks Cold or Hot to the Last Sip
- BPA Free
- Keeps Ice 2x Longer Than Plastic Tumblers

NEW

SEE MORE ON PAGE 103 >>>



SKU 096881
26008
24⁹⁹
REG. \$29.99
SAVE \$5



SKU 096878
26009
19⁹⁹
REG. \$24.99
SAVE \$5



SKU 096882
26010
19⁹⁹
REG. \$24.99
SAVE \$5

Offers Good Thru September 30, 2016 - While Supplies Last

OEMTOOLS

SAVE \$10

3 Cup Box Set

SKU 096887
26014
59⁹⁹
REG. \$69.99



SAVE \$100 to \$200

36" 10 Drawer Chest and Cabinet Combo - Black/Green

SKU OUTSIDE BUY/EPO
24593

- Raise and Release Drawer Latches to Secure Drawers
- Flat Key Locking System
- EVA Drawer Liners Included
- 4 Large Sturdy 5" x 2" Mag Casters
- Full Extension 100 Lbs. Capacity Slides
- Gas Struts for Easy Opening
- Drawer Liners Included

699⁹⁹
REG. \$799.99

41" 16 Drawer Chest and Cabinet Combo - Black/Green

SKU OUTSIDE BUY/EPO
24596

OEMTOOLS

899⁹⁹
REG. \$1099.99



Offer Good Through September 30, 2016 While Supplies Last

Available via Outside Buy/EPO. Call 1-877-424-6431 for details.

SAVE OVER \$500

Combo with geodyna® 7200s Balancer and monty1575 Tire Changer Plus Bead Assist

SKU 080105
HOFCOMB03
REG. \$8,999.97

8,399⁹⁹

- Includes: HOFEEWB746A geodyna® 7200s High Performance Wheel Balancing System and HOFMONTY1575B Tire Changer
- Also Includes Patented Easymont Pro, Aiding In Single-Operator Mounting/Demounting Of Extra-Stiff, Low-Profile, High Performance and Run-Flat Tires

HOFMANN



4,499.99 Tire Changer
4,099.99 Wheel Balancer
+1,399.99 Bead Assist
\$9,999.97 TOTAL
\$8,399.99 COMBO DEAL
\$1,599.98 SAVE

Performance and Value

NEW

INCLUDES On-Site Factory Authorized Training



Price Does Not Include Tires or Rims as Shown.

HOFEEWB746A

Lift Gate Service
SKU 290017
HOFLIFTGATE **95⁰⁰**

Offer Good Through September 30, 2016 - While Supplies Last

Tools and Equipment in This Issue:

A/C Service 26 - 32	Engine Service 84 - 85	Pressure Washers 14
Air Compressors .. 68 - 69	Exhaust Hoses 15	Pullers 87
Air Filters, Drains, Regulators 69	Exhaust Tools 90	Recovery Machines 1, 26, 27, 112
Air Hoses/Reels 72	Extractor Sets 91	Rivet Tools 92
Air Tools and Accessories... 70-71, 73 - 74	Fan Clutch Tools 85	Safety.....107, 110
Alignment 46 - 48	Fans, Evaporative Coolers, Heaters... 13 - 15	Sand Blasting 17
Axle Tools 86	Fender Covers..... 108	Scan Tools..60 - 61, 64 - 65
Ball Joint Sets 86	Flashlights 76 - 79	Screwdrivers...97, 99 - 101
Battery Chargers... 81 - 82	Floor Jacks 50, 54-55	Service Carts..... 20, 25
Battery Service ... 80 - 83	Floor Mats, Seat Covers .108	Shop Heaters 15
Bearing Packer..... 57	Fluid Evacuators-Dispensers 57-58	Shop Presses 52
Bearing Tools.. 80, 86 - 87	Fuel Injection 62	Shop Supplies...108 - 110
Belt Tools..... 85	Generators 16, 19, 69	Smoke Machines 63
Blow Guns 74	Gloves 105 - 107	Soldering Iron Kits.... 19
Body Tools 51, 53, 95	Grease Guns..... 57	Spark Plug Thread Repair..... 91
Booster Packs ... 80 - 83	Hammers..... 70, 92	Spring Compressors... 87
Borescopes 62	Hand Cleaner..... 109	Stools.....109
Bottle Jacks 50, 53	Hand Tools 96 - 102	Surface Prep Tools and Accs.....71, 73
Brake Lathes 65 - 66	Hardware Kits, Fuses, Washers, O-Rings 109	Thermometers 28
Brake Service Tools..66 - 67	Heat Shrink Tub Sets 18, 109	Thread Repair 91
Chassis/Suspension..... 86 - 87	Hole Saw Kits 12	Timing Lights 65
Circuit Testers and Probes 63	Hood Props..... 95	Tire Changers 34 - 36
Compression, Oil Pressure, Vacuum, Fuel Pressure and Back Pressure Gauge Kits..... 62	Hose Clamp Tools..... 58	Tire Service..... 34 - 39
Fluid Handling 5, 59	Jack Stands ... 50 - 53, 75	Tool Sets 96 - 102
Cooling System Adapters 59	Jump Starters..... 80 - 83	Tool Storage 20 - 25
Cooling System Tools..... 58 - 59	Leak Detection..... 30	Torque Wrenches..... 88
Cordless Drills, Impacts..10	Lifts 40 - 46, 48	TPMS 32, 38, 60 - 61
Crankshaft 84	Lighting..... 76 - 79	Transmission Jacks... 51
Creepers..... 108	Lockout Tools..... 92	Tubing Tools..... 31, 90
Cylinder Hones 85	Manifold Guages..... 29	Tubing Benders ... 15, 90
Diagnostic Tools .. 60 - 65	Measuring Tools..... 88	Uniforms.....104
Disconnect Tools 94	Multimeters..... 65	UV Leak Detection 30
Drain Pans..... 42	Oil Drains and Accessories 56 - 57	Vacuums 7, 14
Drill Bits..... 4, 12, 91	Oil Filter Wrenches.... 56	Vacuum Pumps ... 27 - 28
Duralast Hand Tools.. 96-97	Paint And Body..... 95	Vises 17
Engine Lifts and Stands ..52	Parts Washers 17	Welding, Cutting 18
	Pick-Up Tools..... 98	Wheel Balancers.. 36 - 37
	Power Probes 63	Wheel Weights 39
	Power Tools and Accessories 6 - 10, 12	Wire Strippers and Crimpers..... 93
		Wrenches..... 97, 99 - 101

Brands in This Issue:

AIRSEPT ... 27 - 29, 31, 94	FOUNTAIN INDUSTRIES.. 17	OTC- BOSCH 32
ALLDATA 111	FRED V. FOWLER COMPANY 88	PAINT BRUSH CORPORATION 17
ALLTRADE..... 97	GENERAC 14, 16	PANTHER VISION ... 5, 110
AMMCO.. 5, 34, 36, 37, 66	GOODYEAR..... 72	PERFORMANCE TECH..... 86, 94
ARROW PNEUMATICS .. 69	GREATLITE 77, 78	PERFORMANCE TOOL.. 62
ASSOCIATED 81	GREATNECK .. 98, 99, 108	PHOENIX SYSTEMS... 67
ATEQ 38	GRIP-TITE 4, 98, 102	PORTA POWER 51
AUTEL 5, 38, 60, 62	HARDWARE MACHINERY..... 18	PORTACOOOL 13
AUTOMETER..... 49	HECAT 4, 59	POWER PROBE 63
BADA..... 39	HEIN-WERNER..... 50, 51	POWERBUILT..... 101
BARTEC USA..... 38	HESSAIRE 13	PRO-CUT 5, 65
BASELINE..... 35, 37	HOFMANN 1, 3, 34, 36, 40, 46 - 48, 66	PULSAR 19
BENDPAK 15, 40 - 42, 44, 46, 48	INDUCTION INNOVATIONS, INC.... 18	PUMA 69
BLACKHAWK 50, 51	INGERSOLL RAND 68, 70, 73	QSP 47
BRANICK 57, 87	INNOVA 61, 65	RANGER..... 15, 34 - 36, 50 - 52, 54, 66
BRUSH RESEARCH .. 67, 85	JOHN DOW 51, 86	RAPIDAIR 72
BUSTED KNUCKLE	K TOOL INTERNATIONAL .. 75	REDLINE 59, 63
GARAGE..... 98	KNIPEX . 4, 91, 98, 99, 102	ROBINAIR 1, 27
CAL-VAN ... 58, 84, 91, 94	KUBOTA..... 14	ROTARY..... 40, 46
CANDO 61, 63	LANAIR 15	RTI 26
CENTRAL TOOLS... 77, 88	LAUNCH..... 64	SAS SAFETY ... 5, 105, 107
CHALLENGER..... 40 - 42, 44, 46	LAUNCH..... 64	SCHUMACHER..... 82
CHAMPION 4, 16	LINCOLN ... 17, 56, 57, 72	SFA COMPANIES... 42, 50
CHANNELLOCK 4, 102	LISLE..... 25, 39, 56, 57, 65, 67, 73, 84 - 91, 93 - 95	SHARK INDUSTRIES 12, 18, 66, 73, 95
CHICAGO PNEUMATIC.. 68	MAHLE..... 5, 26, 59, 61	SHOP IRON 18-19
COATS 34, 36, 37	MAKITA 1, 4, 8, 9, 12	SLIP-N-GRIP..... 108
COOL-SPACE..... 13	MARSON..... 92	STECK..... 25, 86, 92, 95
CPS 26 - 28	MASTERCOOL.. 26 - 31, 90	STREAMLIGHT 78
CRUSHPROOF HOSE... 15	MECHANIX WEAR 105	SUREFIRE 103
DANMAR 34, 40 - 42, 44 - 46	MEDLINE 106	SYLVANIA..... 110
DEWALT..... 4, 6, 7, 12	MICROFLEX 106	SYMTECH..... 59
DICKIES 104	MIDTRONICS..... 81	TAYLOR BRAND KNIVES .90
DORMAN..... 11	MILTON..... 72, 73	THE MAIN RESOURCE.. 37
DREW TECHNOLOGIES.. 65	MILWAUKEE SPRAYER 67	THE MIBRO GROUP... 109
DURALAST .. 52, 71, 73, 81, 96, 97, 99, 105, 108	MI-T-M..... 69	THERMAL DYNAMICS.. 18
DYNAMIC..... 38	MITYVAC ... 57, 62, 67, 89	THEXTON 29, 39, 52, 63, 89
EAST PENN - DEKA 83	MONTEZUMA..... 20	TIGER BULB 110
ELECTRONIC SPECIALTIES 61, 93	NES 90-91	TORIN..... 53
ENERGYLOGIC..... 5, 15	OEMTOOLS 1, 3, 5, 10, 12, 14, 17, 18, 20 - 25, 27 - 31, 39, 47, 50 - 52, 56 - 59, 61 - 63, 65, 67 - 73, 76 - 78, 80, 81, 84 - 96, 98 - 100, 103, 108, 109	TRACER PRODUCTS... 30
ERNST MFG..... 25	OMEGA..... 50 - 52, 55, 108	TRUSTY COOK INC.... 92
ESI 65	ON THE EDGE 109	TUXEDO..... 43
EXPLORER 78, 79		UEI 65
FIREPOWER 18		VAPER..... 74
FIX A THREAD 91		WATER WORKS..... 17
FJC, INC..... 81		YUKON 83
FORWARD LIFT..... 40 - 42, 44, 46		

NEW ARRIVALS

Power Tools and Accessories

14" Chop Saw

SKU 559014
DWTD28715 **199⁹⁹**

- Tool Free Flange System
- Quick-Change Blade System Lets Users Change Wheels Without a Wrench
- Powerful 15 Amp Motor Provides More Overload Capacity
- Patented 45 Degree Adjustable Fence Allows for Fast and Accurate Angle Cuts
- Soft Starts



DEWALT

20V MAX* 1/4" Impact Wrench (Tool Only)

SKU 559060
DWTDCF885B **119⁹⁹**

- Compact Design Fits Into Tight Areas
- 3 LED Lights
- One-Handed Loading
- 20V Max
- Battery Not Included



DEWALT

BONUS

DML805 Tripod

SKU 010104
MAKGM00001381

Value: **\$79.99**

with Purchase of:

18V Shop Light 2 Pack

SKU 079390
MAKDM1805TWO

18V Shop Light 2 Pack

SKU 079390
MAKDM1805TWO **229⁹⁹**

- 18 Volt Lithium-Ion Cordless/Corded LED Flood Light
- 2 Mode Operation Delivers Up to 750 Lumens
- LED Lights Effectively Illuminate your Work Area without the Heat of Halogen Bulbs



Makita

38 Piece Impact Drill and Driver Set

SKU 847083
MAKT-01373 **24⁹⁹**

- 4 Black Oxide Drill Bits: 1/16", 3/32", 1/8" and 1/4"
- 3 - 3 1/2" Extra Length Drill Bits
- 6 - 2" Power Bits: 2-P2, 2-P3, R15 and R20
- 21 - 1" Bit Tips: Slotted, Phillips, Robertson and Torx
- 1 1/4" to 1/4" Hex to Square Adapter
- Injection Molded Case



Makita

70-Piece Impact Drill-Driver Bit Set

SKU 847085
MAKT-01725 **34⁹⁹**

- Compatible with 1/4" Impact Drivers and 3/8" or 1/2" Driver/Drills
- UltraLok 1/4" Hex Shanks
- Magnetic 3" Bit Holder and Nut Drivers
- Black Oxide Coating to Resist Corrosion
- Compatible with Quick-Change Connector Systems

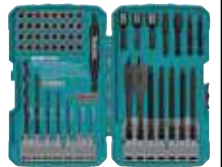

Makita

Offer Good Through September 30, 2016 - While Supplies Last

POWER TOOLS ON PAGES 6-12

Hand Tools

Insulated Automotive Electrical Screwdriver Set

SKU 010812
KNP9K989820US **129⁹⁹**

- Insulated to 1000V
- 10" High Leverage Diagonal Cutter
- 10" Alligator (Self-Gripping) Pliers
- 4" Slotted Screwdriver
- 6" Slotted Screwdriver
- 4" Phillips #2 Screwdriver



KNIPEX

Pro Series 10 Piece 1/2" Drive Metric Socket Set

SKU 005716
GRP00501 **44⁹⁹**

- Socket Sizes: M10, M11, M12, M13, M14, M15, M16, M17, M18, M19
- Dual-Flip Storage Case
- Socket Exceed ANSI Strength Requirements
- Chrome Vanadium Forged Steel
- Black Oxide Coated Cams



GRIP-TITE

9" Rescue Tool

SKU 091685
CHA86 **49⁹⁹**

- Jaw Design Accommodates Many Shapes and Provides Maximum Grip
- Spring and Lock Feature Allows One-Handed Operation
- Ability to Shut Off Gas Safety Valves and Pry Open Windows and Doors
- Spanner Wrench That Tightens Up to 5" Hose Couplings



CHANNEL LOCK

5 Piece Double Edge Bolt and Screw Extractor Set

SKU 042353
KNP9R4719043 **59⁹⁹**

- Contains Sizes 1-5 in a Plastic Tube
- Tip has Built-In Center Punch
- No Additional Tool Required



KNIPEX

Pro Series 7 Piece 1/2" Drive SAE Socket Set

SKU 005714
GRP00502 **44⁹⁹**

- Socket Sizes: 3/8", 7/16", 1/2", 9/16", 5/8", 11/16", 3/4"
- Dual-Flip Storage Case
- Socket Exceed ANSI Strength Requirements
- Chrome Vanadium Forged Steel
- Black Oxide Coated Cams



GRIP-TITE

5 Piece Pro Pliers Set

SKU 019250
CHATOOL ROLL-3 **74⁹⁹**

- Set Includes:
- 9.5" and 10" Tongue and Groove Pliers
- 7" HL Diag Cutting Plier,
- 8" Long Nose
- 6.5" Slip Joint Plier



CHANNEL LOCK

HAND TOOLS ON PAGES 98-103

GENERATORS

3800 Watt Dual Fuel Generator with Electric Start

SKU 020777
CHM76533 **599⁹⁹**

- Run/Start Watts 3800/4750 (Gasoline)
- Runs on Gas or Propane Straight Out of the Box
- Push-Button Electric Start with Battery Included
- Equipped with a Standard 30A RV Outlet
- Volt Guard Protects Your Appliances from Power Surges
- Runs Up to 9 Hours on a Full Tank of Gas or 10.5 Hours on a 20 Lb. Propane Tank



CHAMPION

CARB Compliant

3500 Watt Generator

SKU 020730
CHM46596 **379⁹⁹**

- Run/Start Watts 3500/4000
- RV Ready - Equipped with a Standard 30A RV Outlet
- Volt Guard Protects Your Appliances from Power Surges
- Runs Up to 12 Hours on a Full Tank of Gas
- Starts Easily in Cold Weather
- Durable Steel Frame
- 49 State EPA Compliant



CHAMPION

CARB Compliant

2000 Watt Inverter with Parallel Capability

SKU 020739
CHM735361 **599⁹⁹**

- Run/Start Watts 1700/2000
- Clean Power (<3% THD) - Clean Electricity for Powering Sensitive Electronics
- Operates at 53dBA from 23 Feet
- Runs Up to 9.5 Hours on a Full Tank of Gas
- Parallel Capability - Connect with Another Inverter for Increased Power
- Space Saving Stackable Design with Carrying Handles



CHAMPION

CARB Compliant

SHOP EQUIPMENT 13-19

COOLING SYSTEM

Coolant Pulsator Cooling System Flush Tool

SKU 012619
HCT118550 **699⁹⁹**

- Reduce Comebacks Caused by Low Coolant Flow and Premature Water Pump Failure
- Patented Pulsating Design Removes Restrictive Sludge, Debris, Casting Sand and Scale Deposits to Return Flow to Like New
- Included Accessories Connect with Quick Coupler - Large Rubber Cone, Whip Hose with Small Rubber Cone, 5/8" and 3/4" Hose Barb Connectors and Back Flow Preventer



HECAT

COOLING SYSTEM 58-59

DID YOU KNOW?

AutoZone has over 60,000 specific replacement part numbers for import vehicles through IMC

Contact Your AutoZone Commercial Sales Manager for Details

Fluid Handling

FluidPRO® ATX-2+Boost Transmission Fluid Exchanger

SKU 573105
MSS4008000800 **3,799⁹⁹**

- Fully Automatic Operation
- Precision Fluid Measurement to Minimize Technician Input
- Digital Weight Scale Technology for Accurate Fluid Exchange
- Transmission Pressure Diagnostics



FluidPRO® MCX-2 Multi-Coolant System Fluid Exchanger

SKU 574749
MSS4708003000 **2,499⁹⁹**

- Includes System Pressure Test Feature and "Hot Car" Radiator Cap Pressure Release
- Compatible with All Coolant Types for Adaptability
- Contains Two 7.5 Gal New Coolant Tanks and One 15 Gal Waste Tank Provides Simple, Rapid Switching from One Coolant to Another
- Fast Service Times of 3 Minutes for Increased Productivity



FluidPRO® DFX-1 for Differential Fluid Exchange

SKU 572560
MSS4458000100 **1,299⁹⁹**

- Services All Gear Oils Including Synthetic for Increased Compatibility
- Automatic Operation for Improved Technician Efficiency
- Valved-Hose Ends to Prevent Fluid Spill and Ensure Clean Operation



FluidPRO® ATX+Boost/PS Combo Power Steering/Transmission Unit

SKU 572461
MSS4158001500 **4,299⁹⁹**

- PSX-3 Mounted On Back of ATX 2 Machine
- Fluid Flow Direction Indicator Verifies Correct Hook-Up
- Transmission Diagnostic Pressure Gauge
- Process Time: 3 to 6 Minutes Average Full Exchange



Cart NOT INCLUDED

COOLING SYSTEM 58-59

Diagnostic

TechPRO® Diagnostic Scan Tool

SKU 080045
MSS4028000100 **1,599⁹⁹**

- Includes Automotive Diagnostic System, VCI1000, 1 Year Subscription



TechPRO® Diagnostic Scan Tool with 8" Tablet

SKU 080072
MSS4028000400 **1,999⁹⁹**

- Includes Automotive Diagnostic System, VCI1000, 1 Year Subscription plus 8" Tablet with Preloaded Software



315MHz Universal Programmable MX-Sensors

SKU 080038
AULMXSENS315M **39⁹⁹**

- Built to Perform like OE Sensors in Terms of Signal, Durability and Functionality
- Automotive Battery Grade to Meet Severe Weather Conditions
- High-Precision Air Valve to Prevent Air Leakage
- Replaceable Aluminum Valve Stem is Anodized for Corrosion Resistance
- Robust Clamp-in Pivoting Stem Design Allows for 0-35 Degree Angle Adjustment to Fit All Wheels Types
- The 2-SKU Sensor Solution Covering 98% of All OE Sensors



433MHz Universal Programmable MX-Sensors

SKU 080039
AULMXSENS433M **39⁹⁹**



DIAGNOSTIC 60-65

Engine Service

Ford Cam Phaser Noise Repair Kit 4.6/ 5.4 3V

SKU 079897
24206 **699⁹⁹**

- Adding this Kit to a 4.6/ 5.4L 3V Car, Truck, or SUV Will Help Ensure that Your Cam Phasers Don't Suffer Premature Failure
- Included Timing Chain Wedge Tool Increases Ease of Installation
- Included Simple to Use Vehicle Computer Programmer with OBD-II Cable to Disable Cam Phaser Function
- One Kit Corrects Both Cam Phasers



Cam Phaser Is NOT INCLUDED

Ford Timing Chain Locking Wedge Tool (4.6/ 5.4 3V Engines)

SKU 012647
24207 **19⁹⁹**

- For 2005-14 5.4L and 4.6L 3V
- OE Type Tool
- Allows For Easy Cam Changes Without Removing The Timing Cover



ENGINE SERVICE 84-85

Brake Service

9.2 Lathe w/ 6 Adapter Pkg

SKU OUTSIDE BUY/EPO
PCTPC92-6ADP **10,399⁹⁹**

- Includes: Pro-Cut 9.2 On-Car Brake Lathe, DRO Computer Box, Speed-Lock Cutting Head, Fixed Post Trolley, 6 Adapter Package, Accessory Kit, 6 Adapter Package (50-681, 50-687, 50-688, 50-693, 50-694, 50-946)
- The 6 Adapter Package Will Fit Import and Domestic 4 Lug Applications up Through 1/2 ton Trucks
- On-Site Installation and Training Provided

Available via Outside Buy/EPO, Call (1-877-298-6651) for details.



BRAKE SERVICE 66-67

Safety

Camo LED Glasses

- Adjustable Ultra-Bright Built-In LED Lights
- High-Impact Polycarbonate Lens
- 99.9% UV Protection
- Anti-Fog and Scratch Resistant Lens Coating
- LR44 Batteries Included
- Meets ANSI Z87.1 - 2015

Green SKU 010115 | SAS5421

Tan SKU 010113 | SAS5422

19⁹⁹
19⁹⁹



UNIFORMS AND GLOVES 104-107

Wheel Weights

Tape-A-Weight® Steel Wheel Weight

AZ SKU NUMBER	PART NUMBER	SIZE (OUNCES)	QUANTITY	PRICE
019312	AMM5533601025	0.25	10 Lb. Roll	54.99
019310	AMM5533701050	0.50	10 Lb. Roll	64.99
019304	AMM5533600300	0.25	25 Strips - 12 Segments Each	44.99
019294	AMM5533700500	0.50	24 Strips - 10 Segments Each	54.99
019301	AMM5533800700	1.00	16 Strips - 7 Segments Each	54.99

Tape-A-Weight Roll Dispenser

SKU 019292
AMM5310025 **149⁹⁹**

DOES NOT INCLUDE WEIGHTS



TIRE SERVICE 34-39

Fans



Purchase an HVLS fan from EnergyLogic today to start saving on energy costs all year long!

HVLS Fan Model	Blade Diameter	Number of Blades	Available Blade Lengths	CFM	Industry Spacing	SKU	Part No.	Price
AVD 370	12 ft.	6	6 to 12 ft.	54,000 CFM	48 ft.	012679	ENLEL06000875	\$3,399.99
AVD D3	12 ft.	3	10 to 24 ft.	84,000 CFM	60 ft.	012669	ENLEL06000948	\$4,399.99
AVD D3	14 ft.	3	10 to 24 ft.	117,000 CFM	70 ft.	012693	ENLEL06000949	\$4,399.99
AVD D3	16 ft.	3	10 to 24 ft.	125,000 CFM	75 ft.	012700	ENLEL06000950	\$4,399.99
AVD 550	18 ft.	6	8 to 18 ft.	181,000 CFM	95 ft.	012701	ENLEL06000887	\$5,899.99

Includes fan, mounting hardware, Cat 5 cable, digital touchscreen controller and 50k hour warranty.

SHOP EQUIPMENT 13-19

POWER TOOLS

DEWALT

BONUS TOOL OFFERS VIA MAIL-IN REBATE • OFFERS VALID JULY 1, 2016 THROUGH SEPTEMBER 30, 2016
 All Mail-In Rebate Requests Must Be Postmarked No Later Than **October 29, 2016** • While Supplies Last
 For Rebate Form, Go to WWW.DEWALT.COM/FAQS.ASPX and Type "AUTOZONE" in the Search Field

DEWALT

BUY ANY ONE OF THE TOOLS BELOW

20V MAX* Li-Ion Grease Gun

SKU 559072
 DWTDCG571M1 **269⁹⁹**

- Motor Delivers 10,000 Max PSI
- High-Volume Pump Pushes Up to 5.0 Oz. Min. High-Flow Applications



20V MAX* Li-Ion Compact Drill Driver/ Impact Driver Combo Kit (1.5 Ah)

SKU 559076
 DWTDC280C2 **269⁹⁹**

- DCD780 20V MAX* 1/2" Drill / Driver Features Two Speed Transmission (0-600 / 0-2,000)
- DCF885 20V MAX* 1/4" Impact Driver Features 3 LED Lights with 20 Second Delay After Trigger Release



20V MAX* Li-Ion 3/8" Impact Wrench Kit

SKU 559059
 DWTDCF883M2 **279⁹⁹**

- Compact (5.70" Front to Back), Lightweight (3.4 Lbs.) Design
- XR™ Li-Ion Batteries with Fuel Gauge



20V MAX* Li-Ion Premium 3 Speed Drill Driver Kit (4.0 Ah)

SKU 559047
 DWTDCD980M2 **299⁹⁹**

- 3 Speed All-Metal Transmission
- Heavy Duty 1/2" Metal Ratcheting Chuck with Carbide Inserts



20V MAX* Compact Reciprocating Saw Kit (5.0 Ah)

SKU 695143
 DWTDCS387P1 **299⁹⁹**

- 4 Position Blade Clamp
- 1-1/8" Stroke Length



20V MAX* Li-Ion 1/2" Impact Wrench Kit

SKU 559056
 DWTDCF880HM2 **299⁹⁹**

- Compact (5.70" Front to Back), Lightweight (3.4 Lbs.) Design
- 3 LED Lights with 20 Second Delay After Trigger Release
- Hog Ring Anvil



20V MAX* Li-Ion Grinder Tool Kit

SKU 559068
 DWTDCG412P2 **309⁹⁹**

- 7,000 RPM Motor
- Quick-Change™ Wheel Release



20V MAX* BL Drill/Impact Kit (2.0 Ah)

SKU 850655
 DWTDC283D2 **329⁹⁹**

- Brushless Motor Delivers Up to 57% More Runtime Over Brushed
- XR Li-Ion Batteries Provide 33% More Capacity Over Standards
- 1/2" Drill/Driver Fits into Tight Areas
- 1/4" Impact Driver Is Compact



20V MAX* XR Brushless High Torque 1/2" Impact Wrench Kit with Detent Pin

SKU 850035
 DWTDCF899P1 **349⁹⁹**

- Max Torque: 700 Ft./Lbs.
- Includes: (1) DCF889 - 20V MAX* XR Brushless High Torque 1/2" Impact Wrench with Detent Pin Anvil - Tool (1) DCB205 - 5.0 Ah Battery (1) Multi Voltage Charger
- 1200 Ft./Lbs. of Breakaway Torque



20V MAX* Li-Ion 1/2" High Torque Impact Wrench Kit

SKU 559064
 DWTDCF889HM2 **369⁹⁹**

- 400 Ft./Lbs. of Maximum Torque
- Variable Speed Trigger with Electric Brake
- Hog Ring Anvil



20V Max* Band Saw Kit

SKU 850478
 DWTDCS371P1 **379⁹⁹**

- 2-1/2" Cut Capacity Cuts Up to 2" SCH 40 Pipe
- LED Work Light with 20 Second Delay
- Blade Tracking Adjustment Increases Blade Life
- Dual Bearing Blade Guide Rollers Provide Increased Durability



1/2" High Torque Impact Kit

SKU 803108
 DWTDCF899HP2 **449⁹⁹**

- 20V High Torque Impact Kit
- 1200 Ft./Lbs. of Break Away Torque
- 700 Ft./Lbs. of Max Torque
- 1/2" Anvil with Hog Ring
- Brushless Motor
- LED Light for Visibility



20V MAX Li-Ion Cordless 3 Tool Combo Kit

SKU 818599
 DWTDC398HM2 **519⁹⁹**

- Kit Comes with 1/2" High Torque Impact Wrench, Compact 3/8" Impact Wrench, 2 Li-Ion High Capacity Batteries, Fast Charger and Kit Bag



20V Max High Torque Impact, Grease Gun and LED Combo Kit

SKU 850507
 DWTDC397HM2 **599⁹⁹**

- Grease Gun Delivers 10,000 Maximum PSI
- Flow Rate of Up to 5.0 Fluid Ounces per Minute
- High Pressure Helps to Unclog Seized Grease Fittings
- Brushless Impact Provides Up to 700 Ft./Lbs. of Max Torque
- Includes 3 LED Spotlight



BONUS GET ONE OF THE BELOW VIA MAIL-IN REBATE (YOUR CHOICE)* UP TO A \$134.99 VALUE!

20V MAX* LED Hand-Held Area Light (Tool Only)

SKU 695139
 DWTDCLO50 **79⁹⁹**

- 2 Brightness Settings: 500 and 250 Lumens
- 140° Pivoting Head

Tool Only, Does Not Include Battery or Charger



20V MAX Jobsite LED Spotlight (Tool Only)

SKU 012639
 DWTDCLO43 **94⁹⁹**

- 3 Bright LEDs, 1 Red for Night Vision
- Max Output of 1,000 Lumens
- Beam Is Visible at Up to 1,525'

Tool Only, Does Not Include Battery or Charger



Jobsite Bluetooth® Speaker (Tool Only)

SKU 695141
 DWTDCR006 **99⁹⁹**

- AC/DC Powered
- Runs Off DEWALT 12V MAX*/20V MAX* Battery Packs

Tool Only, Does Not Include Battery or Charger



20V MAX* 1/2" Impact Wrench (Tool Only)

SKU 559055
 DWTDCF880B **129⁹⁹**

- Compact Design Fits Into Tight Areas
- 3 LED Lights
- One-Handed Loading

Tool Only, Does Not Include Battery or Charger



20V MAX* 1/4" Impact Wrench (Tool Only)

SKU 559060
 DWTDCF885B **119⁹⁹**

- Compact Design Fits Into Tight Areas
- 3 LED Lights
- One-Handed Loading

Tool Only, Does Not Include Battery or Charger



20V Li-Ion 4.5" Cut-Off Tool (Tool Only)

SKU 012643
 DWTDCG412B **134⁹⁹**

- 6,500 RPM Motor
- 2 Finger Trigger Switch with Lock-Off Button

Tool Only, Does Not Include Battery or Charger



BUY ANY ONE OF THE TOOLS BELOW

12V MAX* 3/8" Impact Wrench Kit

SKU 559053
 DWTDCF813S2 **159⁹⁹**

- 3/8" Hog Ring Anvil
- 1150 In./Lbs. of Torque
- Three (3) LED Lights
- Compact, Lightweight Design



12V MAX* Cordless Li-Ion Drill Driver/ Impact Driver Combo Kit

SKU 559074
 DWTDC211S2 **199⁹⁹**

- DCD710 12V MAX* 3/8" Drill/Driver Features 2 Speed Transmission (0-400 and 0-1,500)
- DCF815 12V MAX* 1/4" Impact Driver Features (3) LED Lights



12V MAX* Drill/Driver/ Reciprocating Combo Kit

SKU 559075
 DWTDC212S2 **219⁹⁹**

- Includes (1) DCD710 12V MAX* 3/8" Drill/Driver and (1) DCS310 12V MAX* Pivot Reciprocating Saw
- Plus (2) 12V MAX* Li-Ion Batteries, Fast Charger, Belt Hook, (1) 4" 6TPI Wood Cutting Blade, (1) 4" 18TPI Metal Cutting Blade and Kit Bag



12V MAX* Cordless Li-Ion Screwdriver/ Impact Driver Combo Kit

SKU 559073
 DWTDC210S2 **219⁹⁹**

- Includes: DCF610 1/4" Screwdriver, DCF815 1/4" Impact Driver, (2) 12V MAX* Li-Ion Batteries, Fast Charger, (2) Belt Hooks, Contractor Bag



BONUS GET ITEM BELOW VIA MAIL-IN REBATE* \$39.99 VALUE!

12V MAX* LED Work Light (Tool Only)

SKU 559080
 DWTDC1510 **39⁹⁹**

- Bright LED Output - 130 Lumens
- Kick Stand - Hands Free Use in Multiple Placements
- Head Rotates 360° and Pivots



BUY ANY ONE OF THE TOOLS BELOW

7" / 9" Variable Speed Polisher

SKU 559123
 DWTDP849 **179⁹⁹**

- 12.0 Amp
- Electronic Control Maintains Specified Speed Under Load



7" / 9" Variable Speed Polisher with Soft Start

SKU 559124
 DWTDP849X **199⁹⁹**

- 12.0 Amp
- Electronic Module Maintains Specified Speed Under Load
- Hook and Loop Backing Pad, Bale and Straight Side Handle Included



BONUS GET ITEM BELOW VIA MAIL-IN REBATE* \$29.99 VALUE!

Wool Buffing Pad and Backing Pad Kit, 7"

SKU 850657
 DWTDW4985CL **29⁹⁹**

- High Quality Materials for Consistent Performance
- 7" Pad with 5/8-11" Arbor



* For Rebate Form, Go to WWW.DEWALT.COM/FAQS.ASPX and Type "AUTOZONE" in the Search Field.



Contact Us:
1-877-AZTool1 Phone
 (1-877-298-6651) *Hablamos Español*

18V Products

18V 1/2" Cordless Compact Drill Driver Kit

SKU 559022
 DWTDC720KA **199⁹⁹**

- Compact Size
- Lightweight Design (4.8 Lbs.)
- Dual Speed Range



18V Cordless Grease Gun Kit

SKU 559070
 DWTDCG570K **249⁹⁹**

- Powerful Motor Delivers 9,000 Max PSI to Power Through Clogged Grease Fittings
- High-Volume Pump Pushes Up to 5.0 Oz./Min.
- Air Bleeder Valve Assists in Pump Priming After Cartridge Changes



1/2" 18V Cordless XRP™ Impact Wrench Kit

SKU 559024
 DWTDC820KA **279⁹⁹**

- Also Available: DC823KA 3/8" (9.5 mm) 18V Cordless XRP™ Impact Wrench
- Compact Size and Weight
- Replaceable Brushes



1/2" 18V Cordless XRP™ Impact Wrench Kit

SKU 559110
 DWTDW059K-2 **369⁹⁹**

- Also Available: DW059HK-2 1/2" (13 mm) 18V Cordless XRP™ Impact Wrench Kit
- 1,650 RPM/ 2,600 IPM
- Heavy Duty Impact Mechanism



20V Products

20V MAX* Li-Ion Compact Drill Driver Kit (1.5 Ah)

SKU 559042
 DWTDCD780C2 **219⁹⁹**

- High Speed Transmission Delivers 2 Speeds (0-600 and 0-2,000 RPM)
- Ergonomic Handle



20V MAX* XR™ Li-Ion Brushless 1/4" Impact Driver Kit

SKU 559062
 DWTDCF886D2 **219⁹⁹**

- XR™ Li-Ion Batteries with Fuel Gauge
- 3 LED Lights with 20 Second Delay After Trigger Release



Cutting Tools

14" Chop Saw

SKU 559014
 DWTDC28715 **199⁹⁹**

- Tool Free Flange System
- 5.5 Horse Power
- 15 Amp Motor
- Soft Starts



Batteries and Chargers

12V MAX** Li-Ion Battery Pack

SKU 559033
 DWTDCB127 **59⁹⁹**



12V MAX** Li-Ion Battery 2 Pack

SKU 850656
 DWTDCB127-2 **84⁹⁹**



- Compact, Lightweight Design
- Quick 40 Minute Charge Time
- No Memory and Virtually No Self-Discharge

18V XRP™ Battery Pack

SKU 559029
 DWTDC9096 **89⁹⁹**



- Powers Current DEWALT Line of 18V Tools Allowing Users to Run Multiple Tools Off of the Same Battery Pack
- High Capacity XRP™ Battery

12V MAX**/20V MAX* Li-Ion Battery Charger

SKU 559032
 DWTDCB101 **69⁹⁹**

- Charges Current DEWALT 12V MAX**/20V MAX* Li-Ion Batteries
- Charges the Battery in 1 Hour or Less



7.2V-18V NiCad/NiMH/ Li-Ion Fast Charger

SKU 559031
 DWTDC9310 **89⁹⁹**

- Diagnostics with LED Indicator Communicates Battery Charge Status: Charged, Charging, Power Line Problem, Replace Pack and Battery Too Hot or Too Cold



20V MAX* Li-Ion Compact Battery Pack (1.5 Ah)

SKU 559035 | DWTDCB201 **79⁹⁹**

20V MAX* Li-Ion Battery Pack (3.0 Ah)

SKU 559034 | DWTDCB200 **109⁹⁹**

20V MAX* Premium XR™ Li-Ion Battery Pack

SKU 559036 | DWTDCB204 **129⁹⁹**

20V MAX* Premium XR™ (5.0 Ah) Li-Ion Battery Pack

SKU 559037 | DWTDCB205 **149⁹⁹**

20V MAX* (5.0 Ah) Battery 2 Pack

SKU 850488 | DWTDCB205-2 **199⁹⁹**



Corded Tools

4-1/2" Small Angle Grinder with One-Touch™ Guard

SKU 559122
 DWTDE4011 **64⁹⁹**

- 7.0 Amp AC/DC, 12,000 RPM Motor
- One-Touch™ Guard



4-1/2" Small Angle Grinder

SKU 695136
 DWTDE402 **129⁹⁹**

- 7.0 Amp AC/DC, 11,000 RPM Motor
- 2-Position Side Handle
- 4-1/2" One-Touch™ (T27) Guard
- Quick-Change™ Wheel Release Allows Tool Free Wheel Removal



12.0 Amp Compact Reciprocating Saw

SKU 559121
 DWTDE357 **129⁹⁹**



- Keyless Lever Action Blade Clamp with 4 Positions for Additional Versatility
- Variable Speed Trigger

8" Bench Grinder

SKU 559120
 DWTDE758 **149⁹⁹**

- 3/4 HP Induction Motor
- Rugged Cast Iron Base and Motor Housing



1/2" Impact Hog Ring

SKU 559115
 DWTDE293 **189⁹⁹**

- 7.5 Amp Motor Performs at 2,000 RPM
- Produces 2,700 Impacts per Minute
- 1/2" Hog Ring Anvil for Secure Socket Retention



Radios

Jobsite Bluetooth® Speaker

SKU 695141
 DWTDCR006 **99⁹⁹**

- AC/DC Powered
- Runs Off DEWALT 12V MAX*/20V MAX* Battery Packs



Tool Only, Does Not Include Battery or Charger

12V MAX**/ 20V MAX* Worksite Charger Radio

SKU 559081
 DWTDCR015 **189⁹⁹**

- 2 A/C Power Outlets
- Auxiliary and USB Ports
- Device Storage Box



Tool Only, Does Not Include Battery or Charger

Lighting

20V MAX Jobsite LED Spotlight (Tool Only)

SKU 012639
 DWTDCLO43 **94⁹⁹**

- 3 Bright LEDs, 1 Red for Night Vision
- 2 Brightness Settings
- Max Output of 1,000 Lumens
- Drop Tested Up to 2 Meters
- 90 Degree Pivoting Head
- Beam Is Visible at Up to 1,525'



NEW

Tool Only, Does Not Include Battery or Charger

LED Work Light

SKU 695140
 DWTDCLO61 **129⁹⁹**

- 1500 Lumen LED Work Light
- Compatible with 18V or 20V Battery
- AC Outlet for Additional Power
- Adjustable Light Head



Impacts

20V MAX* 1/4" Impact Wrench (Tool Only)

SKU 559060
 DWTDCF885B **119⁹⁹**

- Compact Design Fits into Tight Areas
- 3 LED Lights
- One-Handed Loading
- 20V Max
- Battery Not Included



20 Volt 1/2" Impact Wrench

SKU 559055
 DWTDCF880B **129⁹⁹**

- Compact
- LED Lights
- 20 Volt Max
- Battery Not Included



***With respect to 8V MAX, maximum initial battery voltage (measured without a workload) is 8 volts. Nominal voltage is 7.2.
 **With respect to 12V MAX, maximum initial battery voltage (measured without a workload) is 12 volts. Nominal voltage is 10.8.

*With respect to 20V MAX, maximum initial battery voltage (measured without a workload) is 20 volts. Nominal voltage is 18.

POWER TOOLS

Makita

World's Largest
18V Li-Ion
Tool Platform



3
YEAR
WARRANTY
LEAD-ACID
TOOL &
BATTERY

BONUS

18V 4.0 Ah Battery and Rapid Charger Kit

SKU 847086
MAKBL1840DC1

Value: \$179.99

with Purchase of:
SKU 850532
MAKCOMB01



18V Li-Ion Blower and Trimmer (Tools Only)

SKU 850532
MAKCOMB01 **229⁹⁹**

18V Li-Ion Blower:

- 3 Speed Settings For Optimal Air Velocity Control
- Delivers Maximum Wind Speed of 179 MPH
- Lightweight at Only 3.7 Lbs.

18V Li-Ion Trimmer:

- 7,800 RPM Motor
- Telescoping Shaft Adjusts from 48" - 56"
- Adjustable 5 Position Pivoting Head



MAKDUB182Z



MAKXRU02Z

Tool Only,
Does Not
Include Battery
or Charger

Offer Good Through September 30, 2016 • While Supplies Last

BONUS

18V 4.0 Ah Battery and Rapid Charger Kit

SKU 847086
MAKBL1840DC1

Value: \$179.99

with Purchase of:
SKU 850531
MAKCOMB02



18V Li-Ion 13" Fan and Bluetooth Radio (Tools Only)

SKU 850531
MAKCOMB02 **299⁹⁹**

18V 13" Fan:

- 3 Stage Automatic Timer with 1, 2 and 4 Hour Power-Off Selection
- Tilts Up and Down for Convenient Redirection of Air Flow
- 4 Hours of Continuous Runtime in Low Speed with BL1840 Battery

18V Bluetooth Radio:

- Wirelessly Connect to Your Mobile Device to Play Music
- Protective Bumpers Engineered for Increased Durability
- One Auxiliary Port and One USB Port

MAKDCF300Z



MAKXRM04B

Tool Only,
Does Not
Include Battery
or Charger

Offer Good Through September 30, 2016 • While Supplies Last

BONUS

DML805 Tripod

SKU 010104
MAKGM00001381

Value: \$79.99

with Purchase of:

18V Shop Light 2 Pack

SKU 079390

MAKDML805TWO



18V Shop Light 2 Pack

SKU 079390
MAKDML805TWO **229⁹⁹**

- 18 Volt Lithium-Ion Cordless/Corded LED Flood Light
- 2 Mode Operation Delivers Up to 750 Lumens
- LED Lights Effectively Illuminate Your Work Area without the Heat of Halogen Bulbs



Offer Good Through September 30, 2016 • While Supplies Last

BONUS

70 Piece Impact Drill-Driver Bit Set

SKU 847085
MAKT-01725

Value:
\$34.99

with Purchase of:

12V Impact Driver Drill Kit

SKU 010106

MAKDT03R1

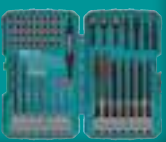

12V Impact Driver Drill Kit

SKU 010106
MAKDT03R1 **149⁹⁹**

- Delivers 970 In/Lbs. of Torque
- 0-2,600 RPMs and 0-3,500 IPM
- Built-In LED Light
- Lightweight at Only 2.3 Lbs.



NEW

Offer Good Through September 30, 2016 • While Supplies Last

BONUS

70 Piece Impact Drill-Driver Bit Set

SKU 847085
MAKT-01725

Value:
\$34.99

with Purchase of:

12V 3/8" Driver Drill Kit

SKU 010110

MAKFD05R1

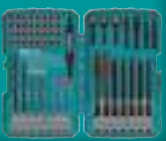

12V 3/8" Driver Drill Kit

SKU 010110
MAKFD05R1 **149⁹⁹**

- Delivers Up to 250 In/Lbs. of Torque
- 2 Speeds: 0-450 and 0-1,700 RPMs
- Adjustable Clutch
- Built-In LED Lights



NEW

Offer Good Through September 30, 2016 • While Supplies Last

BONUS

Microfiber Towels

SKU 751682
MAKT-2664-1

Value: \$14.99

with Purchase of:

7" Variable Electric Polisher and Sander Kit - Corded

SKU 555414

MAK9237CX2



7" Variable Electric Polisher and Sander Kit - Corded

SKU 555414
MAK9237CX2 **199⁹⁹**

- 0 - 3,000 RPM Variable Speed
- Constant Speed Control Maintains Speed Under Load
- Soft Start Feature For Easy Start Ups
- Externally Accessible Brushes for Easy Serviceability
- Includes a Foam Pad and Heavy Duty Tote Bag
- Battery Charger and Tool Bag



Offer Good Through September 30, 2016 • While Supplies Last

SAVE \$20

12V Li-Ion Cordless Combo Kit

SKU 847089
MAKCT226 **179⁹⁹** REG. \$199.99

- 3/8" Driver Drill with 210 Lbs. of Max Torque
- 1/4" Impact Driver with 970 Lbs. of Max Torque
- Includes (2) 12V Slide Batteries
- Batteries Charge in 25 Minutes
- Built-In LED Light



Offer Good Through September 30, 2016 • While Supplies Last

Impact Wrenches

12V Li-Ion 1/4" Hex Shank Impact Driver Kit

SKU 555430
MAKDT01W **124⁹⁹**

- 800 In/Lbs. of Torque and 0-2,400 RPM for a Variety of Applications
- Built-In LED Light Illuminates the Work Area
- Lightweight: 2.0 Lbs.
- (2) 12V Li-Ion Batteries
- Includes Charger and Case



18V Impact Driver Kit

SKU 803113
MAKXDT042 **149⁹⁹**

- 18V Li-Ion Cordless Impact Driver Kit
- Variable Speed
- Quick Charge with Rapid Optimum Charger
- Star Protection Controls
- Compatible with Makita 18V Platform Tools



12V Li-Ion 3/8" Impact Wrench Kit

SKU 555429
MAKWT01W **159⁹⁹**

- 83 Ft/Lbs. of Torque and 0-2,300 RPM
- Built-In LED Light Illuminates the Work Area
- (2) 12V Li-Ion Batteries
- Includes Charger and Case
- 60 Minute Battery Charger



18V Compact Li-Ion 1/2" Cordless Impact Driver Kit

SKU 818601
MAKXDT11R **169⁹⁹**

- Delivers 1,460 In./Lbs. of Maximum Torque
- Variable Speed (0-2,900 RPM and 0-3,500 IPM)
- Includes: XDT04RW 1/4" Hex Shank Impact Driver, (2) BL1820 18V 2.0Ah Li-Ion Batteries, DC18RA Rapid Charger



18V LXT® Li-Ion Cordless 3/8" Impact Wrench Kit

SKU 818598
MAKXWT06R **269⁹⁹**

- Delivers 155 Ft/Lbs. of Maximum Torque
- Includes: 18 Volt Li-Ion Rapid Optimum Charger (DC18RC), 18 Volt LXT Li-Ion 3.0Ah Battery (BL1830) and Tool Bag



18V LXT Li-Ion Cordless High Torque 1/2" Impact Wrench Kit

SKU 849459
MAKXWT04MB **499⁹⁹**

- Delivers 325 Lbs. of Torque
- 1/2" Square Drive
- 1,600 RPMs and 2,200 IPMs
- Includes BL1840B Battery



18V Brushless 1/2" High Torque Impact Wrench

SKU 850509
MAKXWT08M **499⁹⁹**

- 1,180 Ft/Lbs. of Breakaway Torque
- 740 Ft/Lbs. of Fastening Torque
- 3 Speed Selections
- Dual LED Lights
- Includes BL1840 Battery





Contact Us:
1-877-AZTool1 Phone
 (1-877-298-6651) *Hablamos Español*

Combo Kits

12V Combo Kit

SKU 677405
MAKLC209W

- 3/8" Driver Drill Impact Driver
- (2) 12V Max Batteries
- Charger
- Case



12V Li-Ion 3 Piece Combo Kit

SKU 555423
MAKLC314W

- 2 Speed 3/8" Driver-Drill: (0-350 and 0-1,300 RPM) Delivers 200 In./Lbs. of Max Torque
- Variable Speed Impact Driver: (0-2,400 RPM and 0-3,000 IPM) Provides 800 In./Lbs. of Max Torque
- Flashlight Runs Up to 9 Hours on a Single Charge
- (2) Makita 12V Max Li-Ion Batteries
- Battery Charger and Case



12V Li-Ion 3 Piece Combo Kit

SKU 555406
MAKLC319W

- 3/8" Impact Wrench: 83 Ft./Lbs. of Torque
- 1/4" Hex Shank Impact Driver: 800 In./Lbs. of Torque
- Both Tools Have Built-In LED Lights to Illuminate the Work Area
- (2) 12V Li-Ion Batteries for Long Life
- Battery Charger and Tool Bag



12V Li-Ion 3 Piece Combo Kit

SKU 555405
MAKLC309W

- 3/8" Drill Driver: (0-350 and 0-1,300 RPM)
- 3/8" Impact Wrench: 1,000 In./Lbs. of Max Torque (0-2,300 RPM and 0-3,000 IPM)
- Flashlight Runs Up to 9 Hours On a Single Charge
- (2) 12V Max Li-Ion Batteries
- Battery Charger and Case



12V Li-Ion 4 Piece Combo Kit

SKU 555408
MAKLC401W

- Impact Wrench: 83 Ft./Lbs. of Torque
- Hex Shank Impact Driver: 800 In./Lbs. of Torque
- Drill Driver: 200 In./Lbs. of Torque
- Ultra Compact LED Flashlight Runs Up to 9 Hours On One Charge
- All Tools Have Built-In LED Lights to Illuminate the Work Area
- (2) Li-Ion Batteries and Charger



18V Auto Combo Kit

SKU 818600
MAKXT311R

- 3/8" Impact with 155 Lbs. of Torque
- 1/2" Driver with 480 Lbs. of Torque
- BML185 Flashlight
- (2) - BL1820 2.0 Ah Li-Ion Batteries
- 18V LXT Li-Ion Cordless Flashlight
- Tote Bag



Drills

18V 1/2" Hammer Drill Driver

SKU 803111
MAKXP012

- 18V LXT Li-Ion Hammer Driver Drill
- 480 In./Lbs. of Torque



18V Compact Li-Ion Cordless 1/2" Driver-Drill Kit, (2.0 Ah)

SKU 818602
MAKXFD10R

- Variable Speeds 0 - 400 and 0 - 1500 RPM
- 480 In./Lbs. Torque
- Kit Includes: XFD10 18V 1/2" Li-Ion Driver Drill, (2) - BL1820B 18V Li-Ion 2.0Ah Batteries and DC18RC Charger



12V Li-Ion 3/8" Driver Drill Kit

SKU 555431
MAKFD02W

- 3/8" Driver Drill with Keyless Chuck
- 200 In./Lbs. of Torque
- 0 - 350 and 0 - 1,300 RPM
- Built-In LED Light Illuminates the Work Area
- Includes: (2) 12V Li-Ion Batteries, Charger and Case



Grinders

4 1/2" 7.5 Amp Grinder - Corded

SKU 555432
MAK9557PB

- 4-1/2" Grinder with 10,000 RPM for Fast Material Removal
- Powerful 7.5 Amp Motor for Heavy Duty Applications
- AC/DC Switch for Alternative Power Sources
- Small Diameter Barrel and Paddle Switch for Operator Comfort



18V Li-Ion 4 1/2" Grinder (Tool Only) - Rechargeable

SKU 555421
MAKXAG01Z

- 10,000 RPM
- Small Diameter Barrel and Paddle Switch for Ease of Operation
- Operates On 18V 3.0Ah or 4.0Ah Li-Ion Battery



Batteries/Chargers

18V Li-Ion 2.0 Ah Battery

SKU 849432
MAKBL1820B

- 50% More Runtime Than BL1815
- Charges in 25 Minutes

18V Li-Ion 4.0 Ah Battery

SKU 849464
MAKBL1840B

- 35% More Runtime Than BL1830
- Charges in 40 Minutes



18V 5.0 Ah Battery

SKU 849454
MAKBL1850B

- 65% More Runtime Than BL1830
- Charges in 45 Minutes

LED Battery Charge Level Indicator

18V Li-Ion 3.0 Ah Battery

SKU 262507
MAKBL1830

- Compatible with All Makita 18V LXT® and 18V Compact Cordless Tools



18V Dual Port Charger

SKU 751667
MAKDC18RD

- 18V Charger
- Built-In USB Port for Charging Portable Electronic Devices
- Rapid Charge



18V Power Source Adapter

SKU 010107
MAKADP05

- Charges Up to 2 USB Devices
- 2 - 2.1 Amp Outlets
- Built-In Belt Clip
- Rubber Covers Protect USB Ports



18V 4.0 Ah Battery and Rapid Charger Kit

SKU 847086
MAKBL1840DC1

- Full Charge in 40 Minutes
- 35% More Runtime Than 3.0 Ah Battery
- Impact-Resistant Outer
- Shock-Absorbing Inner
- Powers in Extreme Temperatures



18V Lighting

18V LXT Li-Ion Cordless 12 LED Flashlight (Tool Only)

SKU 849456
MAKDML801

- 240 Lumens
- Head Rotates 7 Directions
- Metal Hang Hook Swivels 360°
- 2 Modes - Full Brightness and Half Brightness
- Up to 40 Hours of Illumination at Half Brightness



18V LXT Li-Ion Cordless LED Flashlight (Tool Only)

SKU 849458
MAKDML802

- 200 Lumens
- 12 Position Pivoting Flashlight Head
- Telescopes Up to 58" High
- Up to 13 Hours of Continuous Illumination



18V Shop Light

SKU 821492
MAKDML805

- 8 Volt Li-Ion Cordless/ 115 VAC Corded LED Flood Light
- 2 Mode Operation Delivers Up to 750 Lumens
- LED Light Effectively Illuminates Your Work Area without the Heat of Halogen Bulbs



Tripod Light Stand

SKU 010104
MAKGM00001381

- Holds Up to 2 MAKDML805 Lights
- Telescopes Up to 58" High
- Allows Lights to Swivel
- Lightweight Durable Construction



18V Li-Ion Tools

18V Li-Ion Shop Fan (Tool Only)

SKU 555427
MAKBCF201Z

- Built to Withstand Shop Use
- 3 Speed Settings for Optimal Air Velocity Control
- Includes 115V Plug-In Adapter

Tool Only, Does Not Include Battery or Charger



18V Li-Ion Blower (Tool Only)

SKU 555424
MAKDUB182Z

- 3 Speed Settings for Optimal Air Velocity Control
- Delivers Maximum Wind Speed of 179 MPH
- 12 Minutes of Continuous Runtime with a 3.0Ah Battery
- Blower Only, Does Not Include Batteries or Charger

Tool Only, Does Not Include Battery or Charger



18V LXT Li-Ion Cordless Blower (Tool Only)

SKU 847090
MAKXBU02Z

- Uses (2) BL1850 Batteries (Sold Separately)
- Delivers Up to 29 Minutes of Run Time
- 6 Stage Air Velocity/ Volume Selection Dial
- Zero Emissions - No Gas or Oil Needed
- Weighs Only 9.9 Lbs. with Batteries

Tool Only, Does Not Include Battery or Charger



18V String Trimmer (Tool Only)

SKU 847091
MAKXRU02Z

- 7,800 RPM Motor
- Telescoping Shaft Adjusts From 48" - 56"
- Adjustable 5 Position Pivoting Head
- Only 6.4 Lbs. with Battery (Sold Separately)

Tool Only, Does Not Include Battery or Charger



18V Shop Fan (Tool Only)

SKU 751672
MAKDCF300Z

- 3 Stage Automatic Timer with 1, 2, and 4 Hour Power-Off Selection
- Tilts Up and Down for Convenient Redirection of Air Flow
- 4 Hours of Continuous Run Time in Low Speed with BL1840 Battery

Tool Only, Does Not Include Battery or Charger



18V Shop Radio (Tool Only)

SKU 751668
MAKXRM04B

- Bluetooth Compatible
- Contains a USB Port and an Auxiliary Port
- Runs Up to 20 Hours with an 18V LXT Li-Ion 5.0 Ah Battery

Tool Only, Does Not Include Battery or Charger



Reciprocating Saw

9 Amp Reciprocating Saw HD - Corded

SKU 262515
MAKJR3050T

- Long 1-1/8" Stroke for Faster Cutting
- Internal Dust Blower System Clears Debris from the Line of Cut for Better Visibility and Accuracy
- All Ball and Needle Bearing Construction for Longer Tool Life
- Soft Grip for Increased Comfort and Control



POWER TOOLS

Impact Wrenches

Heavy Duty 1/2" Drive Cordless 20V Li-Ion Impact Wrench

SKU 818594 24481 **199⁹⁹**

- Speed: 0-2,200 RPM and 0-2,900 IPM
- Nut Busting Torque: 300 Ft/Lbs.
- Tightening Torque: 260 Ft/Lbs.
- Battery: 4.0 Ah Li-Ion
- Weight: 8 Lbs.
- 4 Battery Light Indicators: 100% (4), 75% (3), 50% (2) and 25% (1)
- Charge Time: 2 Hours
- Includes Lithium-Ion Battery with Charging Station



Rechargeable Li-Ion 20V 4.0 Ah Battery

SKU 824772 27314A **89⁹⁹**



20V Battery Charging Station

SKU 824773 27314B **29⁹⁹**

- Charges Both 2.0 Ah and 4.0 Ah Batteries



OEM TOOLS

Heavy Duty 1/2" Drive Cordless 20V Li-Ion Drill

SKU 818593 24482 **149⁹⁹**

- Chuck Size: 1/2"
- 2 Speed Gear Box: 0-600 RPM and 0-2,000 RPM
- 4 Battery Light Indicators: 100% (4), 75% (3), 50% (2) and 25% (1)
- Electric Brake
- Clutch: 21 + 1 Torque Clutch Setting
- LED Work Light
- Charge Time: 1 Hour
- Includes Li-Ion Battery with Charging Station and Chuck



Rechargeable Li-Ion 20V 2.0 Ah Battery

SKU 824777 27333A **49⁹⁹**



OEM TOOLS

Heavy Duty 1/2" Corded Impact Wrench

SKU 861352 33680128 **59⁹⁹**

- Heavy Duty Industrial Quality Construction
- Rocker Trigger for Easy One Hand Operation
- Rugged Die Cast Aluminum Gear Housing
- High Quality Molded Carrying Case
- 120V Reversible 7 Amp Motor
- 8 Ft. Cord
- 2,100 RPM
- No Load Speed
- 2,700 Impacts per Minute, 240 Ft/Lbs. of Torque



GreatNeck

Cordless Drills

4.8V Pivoting Screwdriver

SKU 978091 80122 **29⁹⁹**

- Rechargeable NiCad Battery
- Hex Drive Size: 1/4"
- No Load Speed: 220 RPM
- Forward and Reverse Operation
- Includes: 22 Bits, Magnetic Adapter, Charger and Nylon Zipper Tote



GreatNeck

18V Cordless Drill with Battery

SKU 945262 80167 **39⁹⁹**

- Variable Speed and 3/8" Keyless Chuck
- 16 Torque Settings
- 13 Piece Bit Accessory Kit
- No Load Speed: 0-400 / 0-1,150 RPM
- Charge Time: 3 - 5 Hours



GreatNeck

18V Replacement Battery for #80167

SKU 607086 80133-4 **29⁹⁹**



14.4V Cordless 3/8" Impact Wrench with 2 Batteries

SKU 965831 80157 **89⁹⁹**

- Heavy Duty Construction for Strength and Durability
- Rugged Die Cast Aluminum Gear Housing
- Rocker Trigger for Easy One Hand Operation
- Features LED Light and Belt Clip
- Comes with (2) Rechargeable 14.4V Batteries and Charger

80 Ft/Lbs. Maximum Driving Torque



GreatNeck

3/8" Cordless Impact Wrench

SKU 094816 80170 **79⁹⁹**

- 80 Ft/Lbs. Maximum Driving Torque
- Heavy Duty Construction for Strength and Durability
- Rugged Die Cast Aluminum Gear Housing
- Rocker Trigger for Easy One Hand Operation
- Features LED Light and Belt Clip
- Comes with Rechargeable 14.4V Battery and Charger



GreatNeck

14.4V Replacement Battery for Model #80170

SKU 094817 80147 **29⁹⁹**



24V Cordless 1/2" Impact Wrench with 2 Batteries

SKU 965829 80158 **129⁹⁹**

- Heavy Duty Heat-Treated Gears for Strength and Durability
- Comfortable Shock Absorbing Grip
- Variable Speed Trigger for Safety Control
- Maximum Torque: 200 Ft/Lbs.
- Impacts per Minute: 2,700
- Speed: 2,000 RPMs
- Comes with (2) Batteries and Charger



GreatNeck

24V Cordless 1/2" Impact Wrench with Battery

SKU 914606 80165 **99⁹⁹**

- Heavy Duty Heat-Treated Gears for Strength and Durability
- Comfortable Shock Absorbing Grip
- Variable Speed Trigger for Safety Control
- Maximum Torque: 200 Ft/Lbs.
- Impacts per Minute: 2,700
- Speed: 2,000 RPMs
- Comes with 1 Battery and Charger



GreatNeck

24V Replacement Battery for #80165

SKU 989259 80149 **44⁹⁹**



Grinders

Rotary Tool with 35 Piece Accessory Kit

SKU 945261 80134 **19⁹⁹**

- Polish, Grind, Cut, Shape and Sand Metals
- 1/8" - 3/32" Collect Capacity
- Variable Speed Wheel
- Accepts All Standard Accessories and Attachments



GreatNeck

4-1/2" Angle Grinder

SKU 942138 80144 **24⁹⁹**

- Two Position Side Handle
- 120 Volt, 60 HZ
- No Load Speed: 10,500 RPM
- Includes: Side Handle, Grinding Wheel for Metal and Spanner Wrench No Load Speed
- 5 AMP Motor



GreatNeck

Heavy Duty 6" Bench Grinder with Lamp

SKU 412598 80058 **69⁹⁹**

- Solid, Heavy Duty Construction for Shaping and Sharpening Hardened Steel
- 6" Wheels with Tool Rests
- Tool Rests Adjust to 45° or 90° Position
- Includes: Coarse and Fine 6" Grinder Wheels, 2 Position Tool Rests, 45° and 90°, Goose Neck Lamp, Adjustable Eye Guards and Spark Breakers



GreatNeck

Heat Guns

Heat Gun

SKU 237831 80164 **34⁹⁹**

- Built with Power and Comfort to Get the Job Done
- Powerful 1,200 Watt Heating Power
- 3 Position Trigger Switch for On/Off and Temperature Setting



GreatNeck

Dual Temp Heat Gun Set

SKU 094815 80131 **39⁹⁹**

- Powerful 1,500 Watt Motor
- 3 Position Trigger Switch for On/Off and Temperature Setting

10 Piece Set Includes:

- Dual Temp Heat Gun, (4) Nozzle Deflectors, (3) Interchangeable Scraper Blades, Scraper Handle, Scraper and Sturdy Storage Case



GreatNeck

Bench Grinder

Bench Grinder Stand

SKU 818596 80173 **39⁹⁹**

- Works with Most Bench Grinders
- Base: 18-7/8" x 19-3/4"
- Convenient 12-1/2" x 13-3/8" Tool Tray
- Overall Height: 32"
- Non-Skid Rubber Feet

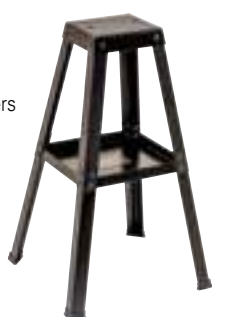

GreatNeck



Contact Us:
1-877-AZTool1 Phone
 (1-877-298-6651) *Hablamos Español*

DORMAN
 NEW SINCE 1918

INNOVATIVE PARTS ENGINEERED TO LAST LONGER

COOLANT RESERVOIRS

OVER 200 SKUs AVAILABLE



Redesigned with thicker, more durable plastic for a longer service life

Includes caps and drain tube (where applicable)

AIR BAG CLOCKSPRINGS

OVER 60 SKUs AVAILABLE



Replace just the failure-prone clock spring without changing the wiring harness

Comes with direct-fit connectors pre-attached, no wiring splicing



Reduce Repair Cost

HVAC CONTROL MODULES

OVER 60 SKUs AVAILABLE



100% backlight bulb and O-Ring replacement

ELECTRIC WATER PUMP

NEW EXCLUSIVE for Popular BMW Applications



Upgraded microcontroller designed to withstand higher current levels and vehicle temperatures

POWER WINDOW SWITCHES

OVER 200 SKUs AVAILABLE

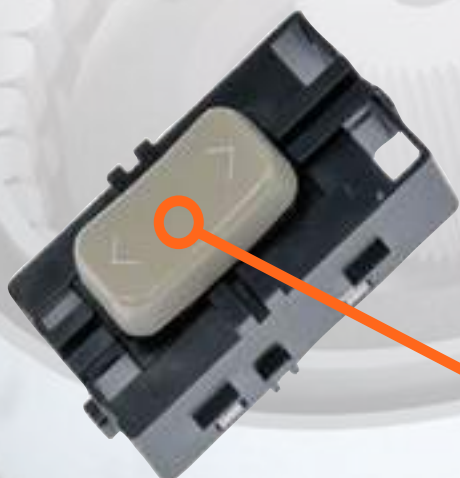

Built with higher quality plastic for a longer service life

Designed to match appearance of original switch

WINDSHIELD WIPER LINKAGES

OVER 200 SKUs AVAILABLE



Upgraded with higher quality plastic bushings for more durability

For more information, visit www.dormanproducts.com/az



POWER TOOLS ACCESSORIES

Hole Saw Set

OEM TOOLS

6 Piece Bi-Metal Hole Saw Set

SKU 547011
24378 **49⁹⁹**

- Slotted Saw Allows for Easier Plug Removal
- Durable Enamel Finish Protects Against Corrosion
- Bi-Metal Construction for Increased Wear Resistance
- Sizes Included: 7/8", 1", 1-1/8", 1-1/4" and 1-1/2" (22 mm, 25 mm, 29 mm, 32 mm and 38 mm)
- Set Comes in a Blow Mold Case



Screwdriver Sets

21 Piece Screwdriver Set

SKU 849590
DWTDW2161 **19⁹⁹**

- 3" Stainless Steel Magnetic Bit Strip
- 1/4" and 5/16" Magnetic Nut Setters
- Phillips, Square, and Slotted Screw Bits
- Includes Tough Case



37 Piece Screwdriving Set

SKU 849592
DWTDW2163 **29⁹⁹**

- Includes Slotted Bits and Bit Tips
- 10 of the Most-Needed No. 2 Phillips Bit Tips
- Power Bits, Square Recess Bits and a Double Ended Bit
- Compact Magnetic Drive Guide
- Includes Tough Case



45 Piece Screwdriving Set

SKU 850468
DWTDW2166 **34⁹⁹**

- Most Common Screwdriver Accessories
- Precise Fitment on No. 2 Phillips Bits
- Double-ended 1" Bits
- Titanium Torsion Bits
- Includes Tough Case



29 Piece Screwdriving Set

DEWALT

SKU 849591
DWTDW2162 **24⁹⁹**

- Compact Drive Guide and Nut Drivers
- Slotted, Phillips, Torx and Square Bits
- Heat Treated for Durability
- Includes Tough Case



40 Piece Impact Ready Screwdriving Set

SKU 850480
DWTDW2164 **29⁹⁹**

- FlexTorq Allows Bits to Flex Up to 15 Degrees
- 10X Magnetic Screw Lock System
- Minimizes Drops and Reduces Wobbling
- Reduces Breakage for Longer Life



80 Piece Screwdriving Set

SKU 850469
DWTDW2587 **54⁹⁹**

- 17 Black Oxide Drill Bits
- Industrial Screwdriving and Fastening Bits
- Magnetic Bit Tip Tray
- Includes Tough Case



Screwdriver Accessories

7 Piece Magnetic Drive Set

DEWALT

SKU 850470
DWTDW2095 **19⁹⁹**

- Self-Retracting Guide Sleeve
- Screws Up to 4"
- Square, Phillips, and Flat Head Bits
- 2" and 4" Magnetic Drive Guides



Grinding Wheels

Depressed Center Hubless Grinding Wheels 4.5" x 1/4" x 7/8" (10 Pack)

SKU 459136
SHA12661 **29⁹⁹**

- Fits 4-1/2" Angle Grinder
- Great for Auto Body Work As Well As All Types of Metal Fabrication and Steel Finishing/Removal
- Max. RPM: 11,900



Depressed Center T27 Hub Grinding Wheels 4.5" x 1/4" x 7/8" - 5/8" - 11NC (10 Pack)

SKU 459155
SHA12662 **39⁹⁹**

- Fits 4-1/2" Angle Grinder with 5/8" - 11NC Arbor
- Great for Auto Body Work As Well As All Types of Metal Fabrication and Steel Finishing/Removal
- Max. RPM: 11,900



14" x 1/8 x 1" Cut-Off Wheel (5 Pack)

SKU 459158
SHA12663 **49⁹⁹**

- Use On Stationary Chop Saws
- Max. RPM: 4,400



4-1/2" x 1/4" x 7/8" Metal Grinding Wheel - 10 Pack

DEWALT

SKU 850482
DWTDW4514B5 **22⁹⁹**

- Heavy Duty Cutting and Grinding of Ferrous Metals
- High Grain Concentration for Aggressive Grinding Action and Smoother Running Wheels
- 3 Full Sheets of Fiberglass for Durability and Safety
- Proprietary Aluminum Oxide Grain Combination



4-1/2" x 0.045" x 7/8" Metal Cutting Wheel - 10 Pack

DEWALT

SKU 850030
DWTDW8424B5 **19⁹⁹**

- Heavy Duty Cutting and Grinding of Ferrous Metals
- Thin .045" Wheel Design for Fast Burr Free Cutting
- Premium Resin Bonds Inspected Before Use
- Proprietary Aluminum Oxide Grain Combination



Bench Grinding Wheel

6" Bench Grinding Wheel

SKU 112398
SHA2017 **14⁹⁹**

- 6" x 3/4" Wheel with 1" Arbor Hole with Reducing Bushings 1/2"-5/8"-3/4"
- 46 Grit



Reciprocating Saw Blades

4" 14 TPI Saw Blade - 5 Pack

SKU 847084
MAK723062-A-5 **19⁹⁹**

- Lasts 10X Longer Than HCS Blades
- 0.035" Blade Thickness
- For Cutting in Metal Under 1/8"
- Pack of 5



6" 14 TPI Saw Blade - 5 Pack

SKU 847080
MAK723066-A-5 **19⁹⁹**

- Lasts 10X Longer Than HCS Blades
- 0.035" Blade Thickness
- For Cutting in Metal 1/8"-3/16" Thick
- Pack of 5



9" 18 TPI Saw Blade - 5 Pack

SKU 847081
MAK723069-A-5 **19⁹⁹**

- Lasts 10X Longer Than HCS Blades
- 0.035" Blade Thickness
- For Cutting in Metal 1/8"-3/16" Thick
- Pack of 5



Metal and Wood Cutting Recip Blade Set

DEWALT

SKU 850474
DWTDW4856 **19⁹⁹**

- Contains 6 Blades
- (4) Metal Cutting Blades
- (2) Wood Cutting Blade
- Raker Tooth Design
- 6 Degree Hook Angle



Metal and Wood Cutting Recip Blade Set

DEWALT

SKU 850473
DWTDW4857 **19⁹⁹**

- Contains 5 Blades
- (3) Metal Cutting Blade
- (2) Wood Cutting Blades



8 Piece 2X Recip Blade Set

DEWALT

SKU 850471
DWTDW4101 **29⁹⁹**

- (3) 6" 6 TPI Recip Blades
- (3) 6" Premium Cutting Blades
- (1) 9" 10 TPI Recip Blade
- (1) 8" Premium Cutting Blade
- (1) Tough Case



Metal and Wood Cutting Recip Blade Set

DEWALT

SKU 850475
DWTDW4892 **29⁹⁹**

- (3) 6" Wood Cutting Blades
- (2) 6" Metal Cutting Blades
- (3) 8" Metal Cutting Blades
- (3) 9" Wood Cutting Blades
- (1) 9" Demolition Blade

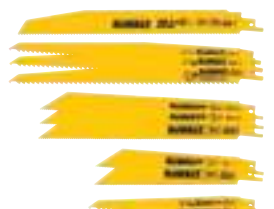

Metal and Wood Cutting Recip Blade Set

DEWALT

SKU 850477
DWTDW4890 **34⁹⁹**

- (5) 6 TPI Woodcutting Blades
- (5) 14 TPI Metal Cutting Blades
- (5) 18 TPI Metal Cutting Blades
- Includes Tough Case



Drill Set

Makita

38 Piece Impact Drill and Driver Set

SKU 847083
MAKT-01373 **24⁹⁹**

- (4) Black Oxide Drill Bits: 1/16", 3/32", 1/8" and 1/4"
- (3) 3 1/2" Extra Length Drill Bits
- (6) 2" Power Bits: 2-P2, 2-P3, R15 and R20
- (21) 1" Bit Tips: Slotted, Phillips, Robertson and Torx
- (1) 1/4" to 1/4" Hex to Square Adapter
- Injection Molded Case



70 Piece Impact Drill-Driver Bit Set

SKU 847085
MAKT-01725 **34⁹⁹**

- Compatible with 1/4" Impact Drivers and 3/8" or 1/2" Driver/Drills
- UltraLok 1/4" Hex Shanks
- Magnetic 3" Bit Holder and Nut Drivers
- Black Oxide Coating to Resist Corrosion
- Compatible with Quick-Change Connector Systems

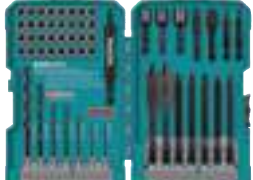

Spiral Step Drill Set

OEM TOOLS

SKU 099189
24372 **39⁹⁹**

- Titanium Coated Finish
- 28 Hole Sizes in 3 Bits
- Bit One: 13 Sizes from 1/8" to 1/2"
- Bit Two: 6 Sizes from 3/16" to 1/2"
- Bit Three: 9 Sizes from 1/4" to 3/4"



35 Piece Master Screw Extractor/Drill Bit Set

SKU 099258
24377 **149⁹⁹**

- Full Range of Spiral and Multi-Spline Extractors for Removing the Toughest Bolts and Screws from 3/32" to 15/16"
- OEM 135° Split Point Left Hand Cobalt Drill Bits, Start Easy and Drill the Toughest Metals



DID YOU KNOW?

AutoZone has the Starting Battery for the 2002 - 2013 Toyota Prius

Contact Your AutoZone Commercial Sales Manager for Details

SHOP EQUIPMENT

Evaporative Coolers

Half the Price of Comparable Coolers

Offers Good Through September 30, 2016 - While Supplies Last

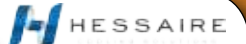

2200 CFM 2 Speed Evaporative Cooler

SKU 849598
HESMC37A **349⁹⁹** REG. \$399.99

- Cools Up to 750 Square Feet
- 3 Speed Variable Motor with Energy Efficient Electronic Timer
- Delivers the Most CFM/\$ On Cooling - \$0.03/Hour
- USB Charging Port Provides Ability to Charge Phones and Accessories
- Dimensions: 37" x 17" x 25"; Weight: 43 Lbs; Water Capacity: 10.3 Gallons



SAVE \$50

5300 CFM 2 Speed Evaporative Cooler

SKU 849597
HESMC61A **549⁹⁹** REG. \$599.99

- Cools Up to 1,600 Square Feet
- 3 Speed Variable Motor with Energy Efficient Electronic Timer
- Delivers the Most CFM/\$ On Cooling - \$0.03/Hour
- USB Charging Port Provides Ability to Charge Phones and Accessories
- Dimensions: 45" x 17" x 28"; Weight: 63 Lbs; Water Capacity: 14.6 Gallons



SAVE \$50

8500 CFM 2 Speed Evaporative Cooler

SKU 019241
HESMFC18000 **1,129⁹⁹** **NEW**

- Cools Up to 2,100 Square Feet
- Uses the Natural Process of Water Evaporation to Reduce Temperatures By Up to 20 Degrees
- Rugged Polypropylene Housing with UV Protection
- Easy Fill Tank Holds 32.8 Gallons of Water, Enough for 3-4 Hours of Operation
- Portable Design with 4 Extra Strength Caster Wheels
- Less than Half the Price of the Competition



18" Evaporative Cooler (Variable Speed)

- Reduces Temperature By Up to 33 Degrees
- 33% More Cooling Surface Than Standard 6" Media
- Garden Hose Connection
- Housing - Constructed of Roto-Molded Corrosion Free Polyethylene
- Fan Motor - High Efficiency, Totally Enclosed 1/2 HP
- Direct Drive: 110 Volt / 1 Ph. / High 2.9 Amps / Low 1.45 Amps
- Cooling Coverage Area - Approx. 1,200 Sq. Ft.

Lift Gate Service
SKU 543687
CLSLIFTGATE **75⁰⁰**



Direct Drive Portable

SKU 850492
CLSCS5-16-VD **1,099⁹⁹**

- Water Reservoir - Internal 16 Gallon Capacity



Tall Base
SKU 850050
CLSCS5-16VDTB **1,399⁹⁹**

- Water Reservoir - Internal 52 Gallon Capacity

CTT-EC Scale Treatment Tablets
SKU 110321 | Part# CLSCS-T101 **39⁹⁹**

- Protect Pads from Hard Water and Scale

Refresh Algae Treatment Tablets
SKU 110322 | Part# CLSCS-T102 **39⁹⁹**

- Prevents Hard Water and Algae from Deteriorating the Pads

36" Evaporative Cooler (Single Speed)

SKU 850052
CLSCS6-36-ID **1,999⁹⁹**

- Reduces Temperature By Up to 33 Degrees
- 33% More Cooling Surface Than Standard 6" Media
- Garden Hose Connection or Portable Supply Tank
- Housing - Constructed of Roto-Molded Corrosion Free Polyethylene
- Fan Motor - High Efficiency, Totally Enclosed 1/2 HP
- Direct Drive: 110 Volt / 1 Ph. / 6.0 Amps
- Water Reservoir - Internal 46 Gallon Capacity
- Cooling Coverage Area - Approx. 2,900 Sq. Ft.



36" Evaporative Cooler (Variable Speed)

SKU 850051
CLSCS6-36-VD **2,699⁹⁹**

- Reduces Temperature By Up to 33 Degrees
- 33% More Cooling Surface Than Standard 6" Media
- Garden Hose Connection or Portable Supply Tank
- Housing - Constructed of Roto-Molded Corrosion Free Polyethylene
- Fan Motor - High Efficiency, Totally Enclosed 1/2 HP
- Direct Drive: 110 Volt / 1 Ph. / High 6.3 Amps / Low 1.8 Amps
- Water Reservoir - Internal 46 Gallon Capacity
- Cooling Coverage Area - Approx. 3,600 Sq. Ft.



BONUS FREE 36" Cooler Cover
SKU 005901 | Part# CLSCSCOVER366
VALUE: \$299.99
with Purchase of:
36" Evaporative Cooler
SKU 850051 | Part# CLSCS6-36-VD

36" Cooler Cover

SKU 005901
CLSCSCOVER366 **299⁹⁹** **NEW**

- Made of Durable, 100% Polyester Fabric with Polyurethane Backing
- Water Repellent Finish Allows Maximum Defense from the Elements
- Fitted Design for 36" Cooler

12" Evaporative Cooler (Variable Speed)

SKU 005816
CLSCSW-12-VD **599⁹⁹** **NEW**

- Reduces Temperature By Up to 20 Degrees
- Garden Hose Connection or Portable Tank Supply
- 4" Thick, High Efficiency Corrugated Media
- Tough, UV Resistant, Durable Molded Polyethylene Housing
- 110 Volt / 1 Ph. / 0.8 Amp
- Water Reservoir - Internal 10 Gallon Capacity
- Cooling Coverage - Approx. 700 Sq. Ft.



48" Evaporative Cooler (2 Speed)

SKU 110318
CLSCS5-48-2B **3,599⁹⁹**

- Reduces Temperature By Up to 33 Degrees
- 33% More Cooling Surface Than Standard 6" Media
- Garden Hose Connection or Portable Supply Tank
- Housing - Constructed of Roto-Molded Corrosion Free Polyethylene
- Fan Motor - High Efficiency, Totally Enclosed 1 HP
- Direct Drive: 110 Volt / 1 Ph. / High 9.6 Amps / Low 5.8 Amps
- Water Reservoir - Internal 64 Gallon Capacity
- Cooling Coverage Area - Approx. 4,700 Sq. Ft.



BONUS FREE 48" Cooler Cover
SKU 005890 | Part# CLSCS-COVER48
VALUE: \$349.99
with Purchase of:
48" Evaporative Cooler
SKU 110318 | Part# CLSCS5-48-2B

48" Cooler Cover

SKU 005890
CLSCS-COVER48 **349⁹⁹** **NEW**

- Made of Durable, 100% Polyester Fabric with Polyurethane Backing
- Water Repellent Finish Allows Maximum Defense from the Elements
- Fitted Design for 48" Cooler

BONUS
CTT-EC Scale and Refresh Treatment Tablets

SKU 110321 | Part# CLSCS-T101
SKU 110322 | Part# CLSCS-T102
VALUE: \$79.98

with Purchase of:
18" Evaporative Cooler

SKU 850492
Part# CLSCS5-16-VD

or
SKU 850050
Part# CLSCS5-16VDTB

PORTACOOL EVAPORATIVE COOLERS



BUILT-IN HANDLES MAKES MOVING AND POSITIONING A SNAP

WATER ADJUSTMENT VALVE KEEPS YOUR EVAPORATIVE COOLER COOLING IN EVEN THE MOST HUMID AREAS

LIQUID LEVEL INDICATOR PREVENTS OVER HEATING AND PROTECTS YOUR INVESTMENT

GFCI PLUG

DUAL WATER FILL

EXTRA LARGE DRAIN ALLOWS FOR EASY AND EFFECTIVE CLEANING

Autozone SKU	Descriptions	Cooling (s.f.)	CFM	Velocity (mph)	Amps	Water (G)	Weight (lb)	Dimensions H X W X D	Electrical Component Warranty	Housing Warranty	Price
850515	Jetstream 270	5,625	22,500	26	20	65	375	90 x 79 x 41	3 Years	Lifetime	\$3,699.99
850517	Jetstream 260	3,125	12,500	25	15	60	267	77 x 67 x 34.5	3 Years	Lifetime	\$2,699.99
850516	Jetstream 250	2,125	8,500	24	9.2	55	213	70 x 55 x 32.5	3 Years	Lifetime	\$2,199.99
850514	Jetstream 240	1,125	4,500	29	5.4	50	152	61 x 42 x 24.5	3 Years	Lifetime	\$1,499.99
850513	Cyclone 3000	700	3,000	27	5.6	16	100	38 x 29 x 25	1 Year	1 Year	\$799.99
850053	Cyclone 2000	500	2,000	30	2.5	10	61	31 x 24 x 25	1 Year	1 Year	\$569.99

PORTACOOL

WHEN COMFORT COUNTS™

SHOP EQUIPMENT

Barrel Fans

24" Barrel Tilt Fan
SKU 688216 **159⁹⁹**
24874

- 24" Tilting Barrel Fan
- 180° Tilt
- 2 Speed High-Efficiency Motor
- 3 Aluminum Fan Blades
- 9,230 CFM
- 6' UL Listed Cord



36" Barrel Tilt Fan
SKU 688217 **279⁹⁹**
24875

- 36" Tilting Barrel Fan
- 2 Speed High-Efficiency Motor
- 3 Aluminum Fan Blades
- 11,280 CFM
- 6' UL Listed Cord

42" Belt Driven Barrel Fan
SKU 688203 **379⁹⁹**
24876

- Versatile 42" Barrel Fan
- 2 Speed Belt Driven Motor
- 4 Aluminum Fan Blades
- 15,800 CFM
- 6' UL Listed Cord



Blower Fans

Portable Mechanic's Fan - 300 CFM
SKU 850064 **69⁹⁹**
24877



Portable Mechanic's Fan - 1,200 CFM
SKU 850066 **89⁹⁹**
24878

- For Indoor or Outdoor Use
- 4 Position Feet
- Great for Use in Shops, Offices, Homes and Other Locations
- 3 Speed Switch
- (2) 11 Amp Grounded Receptacles with Over Current Protection



Fans

20" Floor Fan
SKU 688200 **59⁹⁹**
24870

- 20" High Velocity Floor Fan
- Energy Efficient 3 Speed Motor
- 3 Aluminum Fan Blades
- 4,650 CFM
- 5' UL Listed Cord



20" Internal Orbit Fan
SKU 688199 **99⁹⁹**
24872

- 20" Orbital Fan
- 3 Speed High-Efficiency Motor
- 3 Aluminum Fan Blades
- 4,200 CFM
- 6' UL Listed Cord



20" Oscillating Pedestal Fan
SKU 688197 **119⁹⁹**
24871

- 20" Pedestal Fan
- Oscillating 3 Speed Motor
- 5 Aluminum Blades
- 4,200 CFM
- 6' UL Listed Cord



30" Pedestal Fan
SKU 688201 **199⁹⁹**
24873

- 30" Pedestal Fan
- 3 Speed High-Efficiency Motor
- 3 Aluminum Fan Blades
- 7,250 CFM
- 6' UL Listed Cord



Vacuums

Kubota® 5 Gallon Wet/Dry Vacuum
SKU OUTSIDE BUY/EPO **69⁹⁹**
KUB54101

- This Stainless Steel Vacuum Comes Complete With All Accessories Needed to Get Your Next Household Job Done



Available via Outside Buy/EPO, Call (1-877-298-6651) for details.

Kubota® 8 Gallon Wet/Dry Vacuum
SKU OUTSIDE BUY/EPO **99⁹⁹**
KUB54102

- This 8 Gallon Stainless Steel Vacuum Is Perfect for the Garage, House or Office



Available via Outside Buy/EPO, Call (1-877-298-6651) for details.

Kubota® 14.5 Gallon Leaf Blower Wet Vacuum
SKU OUTSIDE BUY/EPO **139⁹⁹**
KUB54104

- Multi-Functional Large 14.5 Gal Drum with a Convenient Handheld Blower With Wand to Perform for Any Job



Available via Outside Buy/EPO, Call (1-877-298-6651) for details.

Kubota® 12 Gallon Wet/Dry Vacuum
SKU OUTSIDE BUY/EPO **149⁹⁹**
KUB54103

- Large 12 Gal Stainless Steel Push Vacuum Will Ensure All Your Large Jobs Get Done On Time



Available via Outside Buy/EPO, Call (1-877-298-6651) for details.

Kubota® 3 Pack Vacuum Filter Bags
SKU OUTSIDE BUY/EPO **14⁹⁹**
KUB54100

- Multi-Fit Disposable Filter Bag Is Designed for Use with 4-8 Gallon Kubota® Wet/Dry Vacuums

Available via Outside Buy/EPO, Call (1-877-298-6651) for details.



Power Washers

2,500 PSI Residential CARB Compliant Power Washer

NEW

- Powerful Generac Horizontal Shaft OHV Engines Feature Low Oil Shutdown, Engine Oil Is Included
- Easy Access Axial Cam Pump Means No More Kneeling On the Ground to Make Hose Connections
- Ergonomic Generic Spray Guns with Soft Grip and Easy-to-Pull Trigger Reduces Fatigue
- 25' PVC Hose



2,500 PSI
SKU 005721 **289⁹⁹**
GEN6921

2,800 PSI Residential CARB Compliant Power Washer

NEW

2,800 PSI
SKU 005718 **299⁹⁹**
GEN6922



3,100 PSI Residential CARB Compliant Power Washer

NEW

- Powerful Generac Horizontal Shaft OHV Engines Feature Low Oil Shutdown, Engine Oil Is Included
- Easy Access Axial Cam Pump Means No More Kneeling On the Ground to Connection Hoses
- Ergonomic Generac Spray Guns with Soft Grip and Easy-to-Pull Trigger Reduces Fatigue
- 30' PVC Hose



3,100 PSI Commercial Power Washer

SKU 570165 **599⁹⁹**
GEN6590

- Powerful Generac OHV Horizontal-Shaft Engine Features Low Oil Shutdown
- Professional Grade Triplex Pump with Ceramic-Coated Pistons Mean Long Life
- Pressure Control Valve Provides Complete Control of Water Pressure for All Applications
- 5/16" x 35' Hose



These Units are Not for Sale in California, Call for Pricing on CARB Compliant Models

3,800 PSI Commercial Power Washer

GENERAC

SKU 570262 **749⁹⁹**
GEN6564

- Pro-Grade Triplex Pump Up to 4X Longer Life Than Axial Cam Pumps
- Powerful 302 cc Generac OHV Engine Delivers Maximum Cleaning Performance and Reliability
- Low Oil Shutdown Sensor Safeguards the Engine
- 3/8" x 35' Steel Reinforced Rubber Hose



These Units are Not for Sale in California, Call for Pricing on CARB Compliant Models

4,200 PSI Commercial Power Washer

SKU 570263 **899⁹⁹**
GEN6565

- Powerful 420 cc Generac Horizontal Shaft Engine with Low Oil Shutdown, Engineered for Long Life in Demanding Applications
- Professional Grade Triplex Pump with Ceramic Coated Pistons, Designed for Long Life
- Pressure Control Valve Provides Complete Control of Water Pressure
- 3/8" x 50' Steel Reinforced Rubber Hose



These Units are Not for Sale in California, Call for Pricing on CARB Compliant Models



Contact Us:
1-877-AZTool1 Phone
 (1-877-298-6651) *Hablamos Español*

Shop Heaters



NEW



COMPLETE SYSTEMS (include furnace, tank and standard flue kit*)											FURNACES ONLY						
			130 Gallon Tank			200 Gallon Tank			250 Gallon Tank								
Furnace	BTU's	Heats Up To	SKU	Part No.	Price	SKU	Part No.	Price	SKU	Part No.	Price	Furnace	BTU's	Heats Up To	SKU	Part No.	Price
EL-140H	140,000	3,500 Sq. Ft.	012662	ENLE01140102	\$6,499.99	012663	ENLE01140108	\$6,824.99	850048	ENL01140103	\$7,019.99	EL-140H	140,000	3,500 Sq. Ft.	012654	ENLE01140101	\$5,334.99
EL-200H	200,000	5,000 Sq. Ft.	012665	ENLE01200103	\$7,539.99	012657	ENLE01200109	\$7,709.99	850047	ENLE01200104	\$8,074.99	EL-200H	200,000	5,000 Sq. Ft.	012653	ENLE01200101	\$6,164.99
EL-350H	350,000	8,500 Sq. Ft.	NA	NA	NA	NA	NA	NA	850049	ENL01350104	\$9,814.99	EL-350H	350,000	8,500 Sq. Ft.	012656	ENLE01350101	\$8,214.99

*Includes: Waste Oil Furnace and Tank, Swing-Away Burner with Built-In Air Compressor, Accutemp Preheater, Side-suction Metering Pump with Elevated Fuel Pick-Up, Low-fuel Cut Off, Draft Gauge, Fuel Gauge, Drain Valve and Class A Flue Kit

HVLS Fans



Purchase an HVLS fan from EnergyLogic today to start saving on energy costs all year long!

HLVS Fan Model	Blade Diameter	Number of Blades	Available Blade Lengths	CFM	Industry Spacing	SKU	Part No.	Price
AVD 370	12 ft.	6	6 to 12 ft.	54,000 CFM	48 ft.	012679	ENLE06000875	\$3,399.99
AVD D3	12 ft.	3	10 to 24 ft.	84,000 CFM	60 ft.	012669	ENLE06000948	\$4,399.99
AVD D3	14 ft.	3	10 to 24 ft.	117,000 CFM	70 ft.	012693	ENLE06000949	\$4,399.99
AVD D3	16 ft.	3	10 to 24 ft.	125,000 CFM	75 ft.	012700	ENLE06000950	\$4,399.99
AVD 550	18 ft.	6	8 to 18 ft.	181,000 CFM	95 ft.	012701	ENLE06000887	\$5,899.99

Includes fan, mounting hardware, Cat 5 cable, digital touchscreen controller and 50k hour warranty.

NEW



Shop Heaters

Value Package C Thru-Roof Chimney

- 150,000 BTU** SKU 988908 **5,599⁹⁹**
LAN9963C MODEL MX150C
- 200,000 BTU** SKU 988916 **5,799⁹⁹**
LAN9964C MODEL MX200C
- 250,000 BTU** SKU 988923 **6,499⁹⁹**
LAN9965C MODEL MX250C
- 300,000 BTU** SKU 988926 **6,699⁹⁹**
LAN9966C MODEL MX300C



Value Package D Thru-Wall Chimney

- 150,000 BTU** SKU 988912 **5,799⁹⁹**
LAN9963D MODEL MX150D
- 200,000 BTU** SKU 988918 **5,999⁹⁹**
LAN9964D MODEL MX200D
- 250,000 BTU** SKU 988924 **6,699⁹⁹**
LAN9965D MODEL MX250D
- 300,000 BTU** SKU 988893 **6,899⁹⁹**
LAN9966D MODEL MX300D

Leasing Terms Available.[†]
 Ask Your AutoZone® Commercial Sales Manager.
Free Delivery!
 in 48 Continental United States

[†]See Page 2 for More Information



BONUS
Strainer Pan
 Part# MX
VALUE: \$135.98
 with Purchase of:
Lanair Value Package (C or D)

Offer Good Through September 30, 2016
 While Supplies Last

Exhaust Hoses



Crushproof Flarelock Hoses

- Made Exclusively for Cars and Small Trucks
- End Is Flared to Permit Connection of Two or More Links at a Time

- 2.5" x 11'** SKU 977557 ACSFLT250 **129⁹⁹**
- 3" x 11'** SKU 977559 ACSFLT300 **149⁹⁹**
- 3.5" x 11'** SKU 977589 ACSFLT350 **204⁹⁹**
- 4" x 11'** SKU 977590 ACSFLT400 **244⁹⁹**

Crushproof 2.5" Y-Assembly Kit with F250 Adapter

SKU 977549 ACSYA250 **184⁹⁹**

- Designed for Converting Single Hose into Dual Exhaust System Vehicle Purposes



3" Y-Assembly Kit with F300 Adapter

SKU 977550 ACSYA300 **224⁹⁹**

Crushproof 2.5" Service Station Kit

SKU 977547 ACSOSS25 **269⁹⁹**

- Includes:
- (2) Each - 4' x 2-1/2" Hoses
 - (1) Each - 6' x 2-1/2" Hose
 - (1) Each - 2-1/2" Rubber "Y" Connector
 - (2) Each - Straight Tailpipe Adapter, Hook and Chain
 - (1) Each - Splice Connector



3" Service Station Kit

SKU 977548 ACSOSS30 **324⁹⁹**

Crushproof Door Port for 2-1/2" Hose (Rubber)

SKU 977551 ACSDF25 **39⁹⁹**

- Rubber Garage Door Port Adapter
- Designed for 2-1/2" ID



Crushproof Door Port for 3" Hose (Aluminum)

SKU 977552 ACSADF30 **49⁹⁹**

- Aluminum Port Allows Hose to Be Vented Through the Door



Crushproof Door Port for 4" Hose (Aluminum)

SKU 977554 ACSADF40 **69⁹⁹**



Crushproof Straight Tailpipe Adapters with Hook and Chain

- Designed for Easy Adapting to All Sorts of Tailpipes

- 2.5" Straight Tailpipe Adapter with Hook and Chain**...SKU 977591 ACSF250..... **29⁹⁹**
- 3" Straight Tailpipe Adapter with Hook and Chain**.....SKU 977539 ACSF300..... **39⁹⁹**
- 3.5" Straight Tailpipe Adapter with Hook and Chain**...SKU 977540 ACSF350..... **59⁹⁹**
- 4" Straight Tailpipe Adapter with Hook and Chain**.....SKU 977541 ACSF400..... **74⁹⁹**
- 3" x 6" Oval Tailpipe Adapter**.....SKU 977542 ACSF475..... **54⁹⁹**
- 3.5" x 8.5" Oval Tailpipe Adapter**.....SKU 977543 ACSF575..... **64⁹⁹**

Crushproof Bell Hose Adapters

- Designed for Easy Adapting to All Sorts of Tailpipes
- Connects with Ball and Snap

2-1/2" Adapter
SKU 977544 ACSRA250 **49⁹⁹**



3" Adapter
SKU 977545 ACSRA300 **49⁹⁹**



Tubing Benders

Blue Bullet Tubing Bender

SKU 015350 BENB1 **6,669⁹⁹**

- Leg Operated Control Lever at Front Keeps Hands Free
- Two Separate End Finishing Units at Rear for All Necessary Flaring and Expanding
- Degree Plate Located Up Front for Easy Viewing
- Comes Complete with Quick Release Bending and End Finishing Dies
- Includes High-Speed Clampless Swager and Internal Expander
- 3" Bending Capacity (Dies Optional)



3" Die Kit (Optional)

SKU 095070 BEN300-1 **999⁹⁹**



Lift Gate Service
SKU 262533 RANLIFTGATE **135⁰⁰**

Leasing Terms Available.[†]
 Ask Your AutoZone® Commercial Sales Manager.
Free Delivery!
 in 48 Continental United States

SHOP EQUIPMENT

Inverters

ix800 Watt Gas Powered Inverter

SKU 568401
GENIX800

319⁹⁹

- 850 Watt Peak and 800 Watt Running Power Provides Reliable Power to Run Household Appliances, Camping Equipment and More
- 1.5 Gallon Fuel Tank Runs the Generator Continuously for Approximately 3-1/2 Hours
- 38 cc Engine Runs On Gasoline to Provide Dependable Power
- Two 5-15R Outlets Provide Consistent Output with Less Than 3% Total Harmonic Distortion
- Automatic Shut-Off When Oil Levels Are Low to Help Prevent Engine Damage



ix2000 Watt Gas Powered Inverter

SKU 568396
GENIX2000

589⁹⁹

- 2,200 Watt Peak and 2,000 Watt Running Power
- Clean Power for Consistent Output with Less Than 3% Total Harmonic Distortion Is Ideal for Sensitive Electronic Devices Such As Computers and DVD Players
- Digital Inverter Module Converts DC to AC



2000 Watt Stackable Inverter Generator

SKU 020739
CHM735361

599⁹⁹

- Run/Start Watts 1700/2000
- Clean Power (<3% THD) - Clean Electricity for Powering Sensitive Electronics
- Operates at 53dBA from 23 Feet
- Runs Up to 9.5 Hours on a Full Tank of Gas
- Parallel Capability - Connect with Another Inverter for Increased Power
- Space Saving Stackable Design with Carrying Handles
- CARB Compliant



NEW

Gas Powered Generators

GP3250 Portable Generator

SKU 973238
GENGP3250

439⁹⁹

- Rated Watts: 3,250
- Runtime at 1/2 Load: 9.7 Hours
- Outlets: (1) 120V 20A 5-20R Duplex Outlet; (1) 120/240V 20A L14-20R Twist-Lock Outlet
- Gas Tank: 3.5 Gallons
- Low Oil Level Shutdown Automatically Safeguards Engine



Not Available for Sale in California

CARB Models Available

XG8000E Portable Electric Start Generator

SKU 462986
GENXG8000E

1,369⁹⁹

- Rated Watts: 8,000
- Runtime at 1/2 Load: 10 Hours
- Outlets: (1) 120/240V 30A L14-30R Twist-Lock Outlet; (2) 120V 20A GFCI 5-20R Duplex
- Includes: First Oil and Maintenance Kit
- Gas Tank: 9 Gallons
- Low Oil Level Shutdown Automatically Safeguards Engine
- PowerBar™ Easily Monitors Power Being Consumed and Available



Not Available for Sale in California

CARB Models Available

XG10000E Gas Powered Portable Generator with Electric Start

SKU 568407
GENXG10000E

2,099⁹⁹

- User Friendly Controls - Including the Start/Stop, Fuel Shut-Off and Choke Are Conveniently Located On an Illuminated Control Panel
- Track How Much Power You Are Using and How Much Power You Have to Spare with PowerBar™
- Covered Outlets Provide Added Protection from the Environment and Can Stand Up to Rugged Working Conditions



Not Available for Sale in California

GP7500E Watt Gas Powered Portable Generator with Electric Start

SKU 568404
GENGP7500E

999⁹⁹

- Ergonomic Fold-Down Locking Handle to Make Transport and Storage Easy
- Covered Circuit Breaker Protected Outlets Provide Added Protection from the Environment and Rugged Working Conditions
- Electric Start with Recoil Backup Battery Included



Not Available for Sale in California

GP6500E Gas Powered Portable Generator with Electric Start

SKU 568402
GENGP6500E

899⁹⁹

- Generac's 389 cc OHV Engine with Splash Lubrication Provides a Long Engine Life
- Low Oil Shutdown Automatically Safeguards Engine from Damage
- Hour Meter Tracks Maintenance Intervals



Not Available for Sale in California

GP15000 Gas Powered Portable Generator

SKU 568403
GENGP15000E

2,399⁹⁹

- 16 Gallon Fuel Tank Runs the Generator Continuously Up to 10 Hours at Half Load; Idle Control for Improved Fuel Efficiency
- OHVI Engine Is Designed for Extended Runtimes for Use at Jobsites or for an Emergency Backup Power Source
- Circuit Breaker Protected Outlets for Added Safety



Not Available for Sale in California

3500 Watt Portable Generator

SKU 020730
CHM46596

379⁹⁹

- Run/Start Watts 3500/4000
- RV Ready - Equipped with a Standard 30A RV Outlet
- Volt Guard Protects Your Appliances from Power Surges
- Runs Up to 12 Hours on a Full Tank of Gas
- Durable Steel Frame
- 49 State EPA Compliant



NEW

XG7000E Portable Electric Start Generator

SKU 432330
GENXG7000E

1,269⁹⁹

- Rated Watts: 7,000
- Runtime at 1/2 Load: 12 Hours
- Outlets: (2) 120V 20A GFCI 5-20R Duplex Outlets; (1) 120/240V 30A L14-30R Twist-Lock Outlet
- Gas Tank: 9 Gallons
- Low Oil Level Shutdown Automatically Safeguards Engine
- PowerBar™ Easily Monitors Power Being Consumed and Available



Not Available for Sale in California

7500 Watt Portable Generator with Electric Start

SKU 020758
CHM100219

949⁹⁹

- Run/Start Watts 7500/9375
- Touch Start - Battery Included for Push Button Electric Start
- 25' Power Cord Included
- Volt Guard Protects Your Appliances from Power Surges
- Runs on Up To 8 Hours on a Full Tank of Gas
- Intelli-Gauge to Monitor Power Output and Maintenance Intervals



NEW

CARB Compliant

5500 Watt Portable Generator

SKU 020732
CHM41135

679⁹⁹

- Run/Start Watts 5500/6800
- Volt Guard Protects Your Appliances from Power Surges
- Runs Up to 10 Hours on a Full Tank of Gas
- Portable - Folding Handle and Never Flat Tires
- Cold Start - Optimized to Start Easily in Cold Weather
- 120/240V Operation



NEW

CARB Compliant

6500 Watt Portable Generator

SKU 020745
CHM100109

729⁹⁹

- Run/Start Watts 6500/8125
- Volt Guard - Protects your appliances from power surges
- Intelli-Gauge to Monitor Power Output and Maintenance Intervals
- Runs Up to 11 Hours on a Full Tank of Gas
- GFCI Protected Outlets with Covers
- 120/240V Operation



NEW

CARB Compliant

9200 Watt Portable Generator with Electric Start

SKU 020759
CHM100110

1,099⁹⁹

- Run/Start Watts 9200/11500
- 459cc - CARB Compliant for Use in All 50 States
- Touch Start - Push-Button Electric Start and Battery Maintenance Smart Charger
- Equipped with a standard 50A RV outlet
- Volt Guard Protects Your Appliances from Power Surges
- Runs Up to 10 hours on a Full Tank of Gas
- Intelli-Gauge to Monitor Power Output and Maintenance Intervals



NEW

CARB Compliant

Propane Powered Generators

LP3250 Watt LP Fueled Portable Generator

SKU 568405
GENLP3250

619⁹⁹

- 20 Lbs. Fuel Tank Runs the Generator Continuously for Up to 9 Hours (Fuel Tank Sold Separately)
- 212 cc Engine Runs On Propane Gas
- Two 20 Amp, 120V, 5-20R Outlets and One 20 Amp, Twist-Lock L14-20R Outlet
- Low Oil Pressure Protection Safeguards the Engine from Damage



Tank Not Included

CARB Compliant

LP5500 Watt LP Fueled Portable Generator

SKU 568406
GENLP5500

799⁹⁹

- Powered By Propane Fuel, Which Is Easy to Use, Safe to Store, Virtually Non-Toxic and with a Longer Shelf Life and Lower Emissions Than Gasoline
- Integrated Propane Tank Holder Accepts with 20 Lbs. or 30 Lbs. Propane Cylinders for Flexibility, Convenience and Extended Runtimes (Fuel Tank Sold Separately)
- Power Dial Provides Total Control at the Turn of a Dial with All Startup and Shutdown Functions in One Simple, Easy-Access Control



Tank Not Included

CARB Compliant

3800 Watt Dual Fuel Generator with Electric Start

SKU 020777
CHM76533

599⁹⁹

- Run/Start Watts 3800/4750 (Gasoline)
- Runs on Gas or Propane Straight Out of the Box
- Touch Start - Battery Included for Push-Button Electric Start
- Equipped with a Standard 30A RV Outlet
- Volt Guard Protects Your Appliances from Power Surges
- Runs Up to 9 Hours on a Full Tank of Gas or 10.5 Hours on a 20 Lb. Propane Tank



NEW

CARB Compliant

7500 Watt Dual Fuel Generator with Electric Start

SKU 020752
CHM100165

1,049⁹⁹

- Run/Start Watts 7500/9375 (Gasoline)
- Runs on Gas or Propane Straight Out of the Box
- Touch Start - Battery Included for Push-Button Electric Start
- Volt Guard Protects Your Appliances from Power Surges
- Runs Up to 8 Hours on a Full Tank of Gas or 5.5 Hours on a 20 Lb. Propane Tank
- Intelli-Gauge to Monitor Power Output and Maintenance Intervals



NEW

CARB Compliant



Contact Us:
1-877-AZTool1 Phone
 (1-877-298-6651) *Hablamos Español*

SAVE \$50

OEMTOOLS Parts Washers Are a New Generation of Water-Based Parts Washers Providing All the Cleaning Power of Solvent While Using Cleaning Solutions that Are Safe and Biodegradable.

20 Gallon Parts Washer

SKU 300117
24801 **129⁹⁹** REG. \$179.99

- Water-Based Parts Washer with 325 Gallon per Hour Electric Pump
- Steel Work Basin Is 31" (L) x 21" (W) x 34.5" (H)
- Lid Includes Fusible Link for Fire Safety

OEMTOOLS



Offer Good Through September 30, 2016 While Supplies Last

Replacement Washer Pump

SKU 462484 **36⁹⁹**
24800-12

- Fits OEMTOOLS 24800 and OEMTOOLS 24801 Water-Based Parts Washer

DID YOU KNOW?

AutoZone has multiple financing options for large tool or equipment purchases to include Leasing and or interest free extended payment options.

Contact Your AutoZone Commercial Sales Manager for Details

Parts Washer

Flow-Through Brush with Hose

SKU 459114 **26⁹⁹**
PBC50001H

- Oriflo Flow-Through Parts Washer Brush and High Quality Hose to Connect to Your Parts Washer



ORIFLO Flow-Through Parts Brush

SKU 342336 **24⁹⁹**
PBC50001

- Long Lasting, Stiff Trialoy® Polyester Filament Can Be Used with Either Petroleum or Water-Based Cleaning Solutions
- Length: 10.25" (26 cm)



Atlasta Parts Cleaning Brush

SKU 342339 **19⁹⁹**
PBC50003

- A Tough Brush that Will Last and Last
- Length: 9.75" (25 cm)



Parts Brush Division

Air Operated Sprayer

SKU 222507 **49⁹⁹**
LIN5983

- 1/4" NPT (F) Inlet
- Max. Operating Pressure: 150 PSI
- Can Be Used with Solvents or Detergent Solutions



LINCOLN

16 Gallon Solvent Parts Washer

SKU 479979 **449⁹⁹**
FOU62125-01

- Removable Screen Filter for Pump Protection
- Flow Through Brush with Adjustable Fluid Control
- Galvanized Drawn Sink Means No Leaks
- Inside Sink Dimensions: 31"(L) x 21"(W) x 9"(D)



CLEANMASTER

30 Gallon CleanMaster Solvent Parts Washer

SKU 479981 **759⁹⁹**
FOU54821-01

- Includes Drum
- Removable Screen Filter for Pump Protection
- Flow Through Brush with Adjustable Fluid Control
- Galvanized Drawn Sink Means No Leaks
- Inside Sink Dimensions: 31"(L) x 21"(W) x 9"(D)

Includes Drum



CLEANMASTER

12 Gallon CleanMaster Low-Profile Solvent Brake Parts Washer

SKU 479982 **749⁹⁹**
FOU57429-01

- Flow-Through Brush System for Efficient Cleaning
- Durable, Baked-On Powder Coated Epoxy Finish
- Easy-Roll Swivel Casters (2 Locking)



CLEANMASTER

EcoMaster Heated Aqueous Portable Brake Washer

SKU 479988 **999⁹⁹**
FOU61840-02

- Heavy Duty Air Pump
- Heavy Duty Drum Dolly with Two Locking Casters and Two Regular Casters
- Prefilter Screen and Asbestos Sock Filter Designed to Ensure Clean Solution
- Heater: 1,000W - Thermostatically Controlled to Hold at 115° F
- Sink Dimensions: 24" (L) x 20" (W) x 7" (D)



FOUNTAIN INDUSTRIES LTD.

EcoMaster Aqueous Portable Parts Washer

SKU 479987 **849⁹⁹**
FOU61444-02

- Capacity: 45 Gallons
- Heater Thermostatically Controlled Preset to 110° F
- Filter System Prolongs Fluid Life

FOUNTAIN INDUSTRIES LTD.

EcoMaster Heated Aqueous Parts Washer

SKU 479983 **1,449⁹⁹**
FOU61330-02

- Capacity: 45 Gallons
- Heater Thermostatically Controlled Preset to 110° F
- Filter System Prolongs Fluid Life



FOUNTAIN INDUSTRIES LTD.

Molded Cart for EcoMaster Heated Aqueous Parts Washer

SKU 479985 **249⁹⁹**
FOU61332

- 500 Lbs. Capacity
- High Density Polyethylene Molded Tray



FOUNTAIN INDUSTRIES LTD.

OEMTOOLS Parts Washers Are a New Generation of Water-Based Parts Washers Providing All the Cleaning Power of Solvent While Using Cleaning Solutions that Are Safe and Biodegradable.

3-1/2 Gallon Parts Washer

SKU 300128 **69⁹⁹**
24800

- Water-Based Parts Washer with 325 Gallon per Hour Electric Pump
- Steel Work Basin Is 18" (L) x 13.5" (W) x 9" (H)

OEMTOOLS



Replacement Washer Pump

SKU 462484 **36⁹⁹**
24800-12

- Fits OEMTOOLS 24800 and OEMTOOLS 24801 Water-Based Parts Washer

Mobile Parts Washer

SKU 546660 **169⁹⁹**
24804

- Solution Capacity (Gallons): Min. 2 - Max. 4
- Use with Water Works™ Heavy Duty Degreaser Concentrate
- Not for Petroleum Based Solvents
- Weight: 11 Lbs.
- Dimensions: 26" (L) x 18" (W) x 9.5" (H)

OEMTOOLS



Abrasive Blast Cabinet (Bench Top)

SKU 300119 **179⁹⁹**
24815

- Easily Remove Paint, Rust and Oxidation
- Fits On Bench or Cabinet
- Dimensions: 19.3" (H) x 19.3" (W)
- Cubic Inches: 28.6"

OEMTOOLS



40 Gallon Parts Washer

SKU 300118 **279⁹⁹**
24803

- Use with Non-Flammable, Water-Based Degreaser or Cleaning Agent
- Fully Flexible Nozzle and Fusible Link Which Automatically Closes the Lid in Case of Fire
- Dimensions: 44.75" (L) x 20.5" (W) x 35" (H)

OEMTOOLS



Replacement Washer Pump

SKU 462476 **39⁹⁹**
24803-31

- Fits OEMTOOLS 24803 Water-Based Parts Washer

Vises

OEMTOOLS

4-1/2" Light Duty Bench Vise with Swivel Base

SKU 751645 **39⁹⁹**
24216

- Machined Replaceable Steel Jaws
- Machined Anvil, Permanent Pipe Jaws
- Full 360° Swivel Base
- Clamping Strength: 100 Lbs.



4" Heavy Duty Bench Vise with Swivel Base

SKU 751643 **69⁹⁹**
24217

- Machined Replaceable Steel Jaws
- Machined Anvil, Permanent Pipe Jaws
- Full 360° Swivel Base
- Clamping Strength: 200 Lbs.



Drill Presses

OEMTOOLS

5 Speed Bench Drill Press

SKU 462480 **139⁹⁹**
24825

- 1/2" Chuck Capacity
- 1/3 HP, 120V, 2.3 Amp
- 2" Stroke
- 620 - 3,100 RPM
- 8" Swing
- 1/2" Max. Drilling Capacity
- Threaded Depth Lock; Screwdriver Handle
- 6-5/8" x 6-9/16" Table
- 11-5/8" x 7-1/3" Base
- 7" (W) x 16-15/16" (D) x 22-1/2" (H) Overall



16 Speed 15" Heavy Duty Floor Drill Press

SKU 462481 **499⁹⁹**
24826

- 5/8" Chuck Capacity
- 1 HP, 120V, 10 Amp
- 3-11/64" Stroke
- 240 - 3,200 RPM
- 15" Swing
- 3/4" Max. Drilling Capacity
- Threaded Depth Lock; Screwdriver Handle
- 12" x 12" Table
- 17-15/16" x 10-5/8" Base
- 15" (W) x 25-1/3" (D) x 63-1/3" (H) Overall



OEMTOOLS

SAVE \$20

OEMTOOLS

6" Heavy Duty Bench Vise with Swivel Base

SKU 751654 **79⁹⁹**
24218 REG. \$99.99

- Machined Replaceable Steel Jaws
- Machined Anvil, Permanent Pipe Jaws
- Full 360° Swivel Base
- Clamping Strength: 300 Lbs.



Offer Good Through September 30, 2016 While Supplies Last

SHOP EQUIPMENT

Welding/Cutting

MIG, Stick and TIG* Welding Capabilities in One Package

BONUS
WITH MAIL-IN REBATE
Rebate Form Available at
www.firepoweronline.com

Welding Cart
SKU 849600 | Part# THE1444-0900
VALUE: \$139.99

with Purchase of:
**MST 140i Welder, MST 180i Welder
or Plasma Cutter CUTMASTER 42**
SKU 688017 | Part# THE1444-0870 or
SKU 688020 | Part# THE1444-0871 or
SKU 301766 | Part# THE1-4200



MST 140i Welder*
SKU 688017 THE1444-0870 **749⁹⁹**

Firepower

- Includes: Firepower MST 140i Power Supply, Firepower 140 Amp MIG Gun, Firepower Argon/CO² Pressure Regulator/Gauge and Hose, Electrode Holder and Ground Clamp, Drive Roll and Contact Tips, 15-20 Amps Power Adapter, Shoulder Strap and CD with Multi-Language Operating Instructions



Offer Good Through September 30, 2016
While Supplies Last

MST 180i Welder*
SKU 688020 THE1444-0871 **999⁹⁹**

Firepower

- Includes: Firepower MST 180i Power Supply, Firepower 180 Amp MIG Gun, Firepower Argon/CO² Pressure Regulator/Gauge and Hose, Electrode Holder and Ground Clamp, Drive Roll and Contact Tips, Standard 230V Plug, Shoulder Strap and CD with Multi-Language Operating Instructions



Offer Good Through September 30, 2016
While Supplies Last

Plasma Cutter CUTMASTER 42
SKU 301766 THE1-4200 **1,399⁹⁹**

THERMAL DYNAMICS

- Includes: CUTMASTER 42 Power Supply, All New SL40 Torch, Safety Gloves and Glasses, Instructional Plasma Cutting DVD, Consumables Set, Heavy Duty Carrying Case and Power Plug Adapters



Offer Good Through September 30, 2016
While Supplies Last

SAVE \$15

Stars and Stripes Darkening Welding Helmet
SKU 850068 THE1441-0087 **94⁹⁹** REG. \$109.99

- Variable Shade - Adjustable Welding Shade Levels from 9 to 13
- "Welding" or "Grinding" Selection for Process Mode
- Solar-Powered - So You Don't Have to Worry About Changing Batteries - Ever



Offer Good Through September 30, 2016
While Supplies Last

OEM TOOLS

Auto Darkening Welding Helmet with Grinding Function
SKU 347233 24358 **79⁹⁹**

- Variable Shade 9-13, Variable Sensitivity and Delay Controls
- Viewing Area: 3.62" x 1.65"
- Battery Powered with Solar Assist
- Includes Replacement Cover Lenses CE, ANSI Z87.1, CSA Z94.3, AS/NZS Approved



OEM TOOLS

Auto Darkening Welding Helmet
SKU 362974 24357 **49⁹⁹**

- TIG Rated Variable Shade 9-13
- Viewing Area: 3.54" x 1.37"
- Battery Powered with Solar Assist
- Includes Replacement Cover Lenses



Pro-Tack Plastic Welder
SKU 255799 SHA17030 **329⁹⁹**

SHARK USA

- Eco-Friendly Plastic Welder that Is Great for Repairing Virtually Anything Made of Plastic
- Capable of Ironing Plastic to a Smooth Finish
- LED Read Out
- Rated to a Maximum of 65 Amps and Has 4 Power Settings
- Kit Includes: (4) Staple Styles, (2) Ironing Blades, Plastic Box for Staples and Plastic Storage Case



TIG[®] Torch and Accessories
SKU 295859 THEW4013802 (Required for TIG[®] Welding) **189⁹⁹**

THERMAL DYNAMICS

- TIG Torch, 17V, 13", 8 Pin and Accessory Kit with 1/16", 3/32", 1/8" Thoriated
- Tungstens; 1/16", 3/32", 1/8" Collets; 1/16", 3/32", 1/8" Collet Bodies
- No. 5, 6, 7 Alumina Nozzle; Short Back Cap; Long Back Cap



*TIG welding requires purchase of THEW4013802 Accessory Kit

Core-Cut Staples (100 Pack)
49⁹⁹ ea.

SHARK USA

Flat Square	SKU 255808	SHA17031
Outside Corner/Sm. Wave	SKU 255809	SHA17032
Outside Corner/No Wave	SKU 255820	SHA17033
Inside Corner/Sm. Wave	SKU 255839	SHA17034
Inside Corner/No Wave	SKU 255843	SHA17035
Flat Small Wave	SKU 255845	SHA17036
Flat "S" Type	SKU 255851	SHA17037

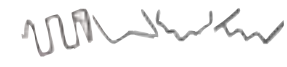

SHOP IRON SOLAR POWERED AUTO DARKENING WELDING HELMETS

SKU 102313 41288 SKU 102314 41290 **99⁹⁹ EACH**

- Extra large viewing area: 3.86" x 2.17"
- Automatically darkens in 1/30,000 of a second
- Ultra high performance filters protects against UV and IR
- Variable shades from DIN 9 to DIN 13
- Outside sensitivity adjustments provide clear vision both prior and during welding
- Durable, light weight material is corrosion resistant and flame retardant
- Special turnover headband mechanism allows for greater comfort and reduces fatigue
- Utilizes high performance solar cells w/ 2 built-in 3V lithium batteries as power back-up
- Complies with DIN, ISO, EN safety standards and ANSI Z87.1-2003 standard



Heat-Shrink Tube Sets

171 Piece Heat-Shrink Tube Set
SKU 420335 68165 **19⁹⁹**

- Protection and Insulation of Components and Wires
- Protection Against Water and Moisture Ingress Preventing Corrosion
- Color Coordinated Sizes
- Quick and Simple to Shrink by Heat Gun



106 Piece Waterproof Heat Shrink Tube Set
SKU 420334 68164 **29⁹⁹**

- Tubes Shrink to Fit Over Cable Splices and Can Be Used for Wire Harnessing, Covering, Marking and Bundling of Wires
- Adhesive Lined Inner Wall to Seal Out Moisture
- 3:1 Shrink Ratio
- Waterproof



REPAIR IT RIGHT

90 Piece Waterproof Heat Shrink Terminal Set
SKU 462482 68166 **79⁹⁹**

- (30) Ring Connectors
- (15) Butt Connectors
- (15) Tin Butt Connectors
- (15) Female Disconnects
- (15) Male Disconnects
- Re-Sealable Plastic Case



BUY ONE GET ONE FREE

Mechanic's Mini Torch
SKU 804655 24353 **19⁹⁹**

OEM TOOLS

- Designed for Light Welding, Auto Repair and Heating Material in Confined Spaces
- Adjustable Flame Lights Upside Down
- Auto Ignition, Refillable
- Safety Lock When Not in Use
- Butane Not Included



Offer Good Through September 30, 2016 - While Supplies Last

Welding Accessories

WIRE

MIG Solid Wire E70S6 - .023 - 2 Lbs.	SKU 459160	SHA12000	16⁹⁹
MIG Solid Wire E70S6 - .023 - 11 Lbs.	SKU 459162	SHA12001	34⁹⁹
MIG Solid Wire E70S6 - .030 - 11 Lbs.	SKU 459164	SHA12003	29⁹⁹
MIG Solid Wire E70S6 - .035 - 33 Lbs.	SKU 459173	SHA12007	64⁹⁹
Flux Core Welding Wire - .030 - 2 Lbs.	SKU 459175	SHA12008	29⁹⁹
Flux Core Welding Wire - .035 - 2 Lbs.	SKU 459180	SHA12009	24⁹⁹

TIPS (25 PACK)

Lincoln MIG Contact .030 Tips	SKU 343402	SHA12874	24⁹⁹
Lincoln MIG Contact .035 Tips	SKU 343403	SHA12875	24⁹⁹
Miller MIG Contact .030 Tips	SKU 343404	SHA12877	24⁹⁹
Benzel and Tweco MIG Contact .023 Tips	SKU 343399	SHA12937	19⁹⁹
Benzel and Tweco MIG Contact .030 Tips	SKU 343401	SHA12938	24⁹⁹

ELECTRODES

E6011 1/8" Electrode 5 Lbs.	SKU 988902	THE14400106	19⁹⁹
E7018 1/8" Electrode 5 Lbs.	SKU 988904	THE14400186	19⁹⁹



250 Piece Welding Stud Assortment
SKU 271198 68130 **18⁹⁹**

- 250 Piece, 3/40" Size
- Use with Stud Welder or Stud Gun
- Copper Coated Steel Construction



Leather Welder's Gloves
SKU 972316 THE14230051 **24⁹⁹**

THERMAL DYNAMICS



Soldering

Mechanic's Torch
SKU 802236 24354 **24⁹⁹**

- Designed for Auto Repair, DIY Household Repair and Professional Soldering, Micro Welding and Brazing
- Heavy Duty Piezo Ignition with Strong Flame
- ABS Grip
- CPSC Approved and Child Restraint Safety Latch
- Butane Not Included



Professional 3-in-1 Butane Micro Torch Kit
SKU 420339 24356 **39⁹⁹**

- 3-in-1 Design Can Be Used As a Soldering Iron, Torch or Hot Air Blower without Iron Tip
- Easy to Set On Table Top with the Base After Operation
- Micro Torch Kit Includes: Torch, Metal Tip Wicking Cup with Sponge, Heat-Shrink Deflector, Chisel Point Tip, Anvil Solder Tip, Needle Tip and Hot Air/Soldering Tip and Base
- Ideal for Use with Electrical Repair, Tin and Plastic Melting, Heat-Shrinkable Tubing, Auto Repair, Hobby Repair and Jewelry Repair
- Power Range: 30w - 125w



Professional 3-in-1 Soldering Iron Kit
SKU 420338 24355 **39⁹⁹**

OEM TOOLS

- 3-in-1 Design Can Be Used As a Soldering Iron, Torch or Hot Air Blower
- Soldering Iron Kit Includes: Soldering Iron, Metal Tip Wicking Cup with Sponge, Solder Wire, Protective Tip Cap, Heat-Shrink Deflector, Chisel Point Tip, Anvil Solder Tip, Needle Tip and Hot Air/Soldering Tip



Mini-Ductor Induction Heater Kit
SKU 436079 IDIMD-600 **419⁹⁹**

- Flameless Heating of Frozen Nuts, Bearings, O2 Sensors and Other Seized Hardware
- No Collateral Damage As with a Torch





Contact Us:
1-877-AZTool1 Phone
 (1-877-298-6651) *Hablamos Español*

SHOP IRON

INVERTER TECHNOLOGY



SKU **554014** **899⁹⁹**
 41198

- Welds 24 gauge up to 5/16" mild steel in a single pass
- Flux-Cored (no gas): tackles the biggest jobs
- MIG (requires shielding gas): weld up to 5/16" mild or stainless steel
- DC Stick: handles up to 5/32" stick electrodes
- Includes: 10ft MIG torch with .030 tip, 10ft ARC lead, 10ft work cable with clamp, 115 /230 V power adapter & argon flow meter/regulator

DUAL VOLTAGE 115V / 230V



SKU **554022** **599⁹⁹**
 41199

- Rated 1/4" clean cut on mild steel with 1/2" rough sever
- Cuts mild steel, stainless, brass, aluminum and other conductive materials
- Includes: 10ft work cable with clamp & 115 / 230V power adapter



2,700 PSI RESIDENTIAL POWER WASHER

SKU **4863** **449⁹⁹**
 FPWG2700H-J

- Built Ford Tough, Single Cylinder, 4 Stroke, 180 CC OHV Engine
- 3 Pistol Axial Cam Annovi Reverberi Pump For Optimal Cleaning Performance
- Fold Down Cushion Grip Handle Allows Comfortable Mobility and Simple Storage
- Includes 25' High Pressure Hose, Ergonomic Spray Gun and Engine Oil

CARB Compliant



2,700 PSI RESIDENTIAL POWER WASHER

SKU **4860** **349⁹⁹**
 PGPW2700H-A

- Single Cylinder, 4 Stroke, 180 CC OHV Engine
- 3 Quick Connect Tips To Adjust Spray Patterns, Plus A Soap Nozzle
- 25' Braided High Pressure Hose For Added Durability
- 12" Never-Flat Tires To Increase Mobility and Stability
- 2700 PSI Max Cleaning Pressure At 2.3 GPM

Not Available for Sale in California



3,100 PSI RESIDENTIAL POWER WASHER

SKU **4862** **499⁹⁹**
 PWG3100H

- Single Cylinder, 4 Stroke, 208 CC OHV Engine
- 4 Quick Connect Tips To Adjust Spray Patterns, Soap Nozzle, And Turbo Nozzle For The Toughest Jobs
- 30' Braided High Pressure Hose For Added Durability
- 12" Never-Flat Tires To Increase Mobility and Stability
- Onboard Soap Tank
- 3100 PSI Max Cleaning Pressure At 2.5 GPM

Not Available for Sale in California



FORD FG3050P WATT Gas Powered Portable Generator

SKU **4673** **449⁹⁹**
 FG3050P

- 3,050 Watt Peak and 2,500 Watt Running Power
- Includes USB Outlets For Your Modern Devices
- Rubber Outlet Dust Covers
- 11 hour Run Time @ 50% Load
- Large 4 Gallon Fuel Tank

Not Available for Sale in California



FORD FG4650P WATT Gas Powered Portable Generator

SKU **4688** **599⁹⁹**
 FG4650P

- 4,650 Watt Peak and 3,600 Watt Running Power
- Rubber Outlet Dust Covers
- 11 hour Run Time @ 50% Load
- Automatic Voltage Regulation
- Mobility Kit

Not Available for Sale in California



FORD FG6250P WATT Gas Powered Portable Generator

SKU **4837** **749⁹⁹**
 FG6250P

- 6,250 Watt Peak and 5,250 Watt Running Power
- Rubber Outlet Dust Covers
- 11 hour Run Time @ 50% Load
- Chrome Ford Inspired Rims
- Fold Down Handles

Not Available for Sale in California



FORD FG7750PE WATT Gas Powered Portable Generator

SKU **4839** **799⁹⁹**
 FG7750PE

- 7,750 Watt Peak and 6,250 Watt Running Power
- Rubber Outlet Dust Covers
- 10.5 hour Run Time @ 50% Load
- Electric Start
- Fold Down Handles

Not Available for Sale in California



FORD FG11050PE WATT Gas Powered Portable Generator

SKU **4857** **1,199⁹⁹**
 FG11050PE

- 11,050 Watt Peak and 9,000 Watt Running Power
- Rubber Outlet Dust Covers
- 9.5 hour Run Time @ 50% Load
- Electric Start
- Fold Down Handles

Not Available for Sale in California



PULSAR PG2000IS WATT Portable Inverter Generator

SKU **4821** **599⁹⁹**
 PG2000IS

- 2,000 Watt Peak and 1,600 Watt Running Power
- Stable Sign Wave for Sensitive Electronics
- Strong 80cc OHV Engine
- Runs 8 Hours @ 50% Load
- Includes 12v Charging Cable



PULSAR PG5250B WATT Portable Dual Fuel Generator

SKU **103253** **599⁰⁰**
 PG5250B

- Runs On Gasoline and Propane
- Gasoline: 5250w Peak and 4250w Running
- Propane: 4750w Peak and 3850w Running
- 3-in-1 Digital Meter
- Strong 7HP OHV Engine

Not Available for Sale in California



Propane Tank not Included

PULSAR PG7750B WATT Portable Dual Fuel Generator

SKU **4668** **999⁹⁹**
 PG7750B

- Runs On Gasoline and Propane
- Gasoline: 7750w Peak and 6250w Running
- Propane: 7350w Peak and 5950w Running
- Electric Start
- Strong 15HP OHV Engine

Not Available for Sale in California



PULSAR PG10000 WATT Gas Powered Portable Generator

SKU **4642** **1,099⁹⁹**
 PG10000

- 10,000 Watt Peak and 8,000 Watt Running Power
- Strong 15HP 420cc OHV Engine
- Electric Start
- 3-in-1 Digital Meter
- Automatic Voltage Regulator

Not Available for Sale in California



PULSAR PG2200 WATT Portable Dual Fuel Generator

SKU **4625** **299⁹⁹**
 PG2200

- Runs On Gasoline and Propane
- Gasoline: 7750w Peak and 6250w Running
- Propane: 7350w Peak and 5950w Running
- Electric Start
- Strong 15HP OHV Engine

Not Available for Sale in California



TOOL STORAGE



Contact Us:
1-877-AZTool1 Phone
 (1-877-298-6651) *Hablamos Español*

CLASSIC SERIES

- Perfect for Startup Or Experienced Pro, You Can Rely On These Classics for Years
- Easily Load Up Your Drawers and Still Maneuver Your Storage Combo to Your Project
- Ball Bearing Full Extension, 100 Lbs. Capacity Drawer Slides
- Dual Sets of Drawer Slides On Larger Drawers
- Gas Struts On Lids for Easy Opening

6 Drawer Tool Service Cart

499⁹⁹

OEM TOOLS

Professional Service Carts Feature Injection Molded Corner Bumpers to Protect Vehicles and Other Objects in Your Shop

BUMPERS
 SKU 420342
 24968 Red



These 6 Drawer Tool Service Carts Feature:

- Locking Top and Drawers
- Lid Has Gas Struts for Easy Opening
- Easy to Maneuver with (4) Large 5" By 2" Swivel Casters: (2) Standard and (2) Locking
- Stays Securely in Place with (2) Locking Casters
- Ball Bearing Full Extension, 100 Lbs. Capacity Drawer Slides
- Drawer Liners
- Raise and Release Drawer Latches to Prevent Opening While Cart Is in Motion
- Dimensions: 37.4" x 20" x 40.5" (W x D x H)
- Storage Capacity: 9,660 Cubic Inches



SKU 420340
 24966 Black



SKU 420331
 24969 Green



SKU OUTSIDE BUY/EPO
 24630 Orange

Available via Outside Buy/EPO, Call (1-877-298-6651) for details.



SKU 420341
 24967 Blue

SAVE \$199⁹⁹ ON A COMBO PURCHASE

Upper Chest: \$499.99
 Lower Cabinet: \$499.99
 Total: \$999.98
TOTAL SAVINGS: \$199.99

36" Tool Storage Combo

- Designed for Organizational Ease and Tool Visibility
- 36" Crossover Top Chest and 6 Drawer Roller Cabinet Tool Box Combo
- Dimensions: 36" (W) x 18-3/8" (D) x 62-1/2" (H)
- Cubic Inches: 25,508
- Scratch Resistant Powder Paint and Textured Aluminum Trim
- Interchangeable Drawers with Premium Drawer Liners, Air Tool Holders and 100 Lbs. Ball Bearing Drawer Slides

799⁹⁹



Red
 SKU 547958
 MTZRR36XOTCOR

Green
 SKU 547961
 MTZRR36XOTCLG



36" Tool Storage Combo - Black

- Designed for Organizational Ease and Tool Visibility
- 36" Crossover Top Chest and 6 Drawer Roller Cabinet Tool Box Combo
- Dimensions: 36" (W) x 18-3/8" (D) x 62-1/2" (H)
- Cubic Inches: 25,508
- Scratch Resistant Powder Paint and Textured Aluminum Trim
- Interchangeable Drawers with Premium Drawer Liners, Air Tool Holders and 100 Lbs. Ball Bearing Drawer Slides

799⁹⁹



Price of Combo is for Chest and Cabinet Only.

Lift Gate Service
 SKU 295540
 OEMLIFTGATE **80⁰⁰**

36" Upper Chest

- 16 Gauge Steel Construction, Welded Seams, No Spot Welding
- 36" x 18" x 21" with Pegs, Slots and Holes for Organizing All Your Tools
- Weather Stripping Creates a Tight Seal Against Dust and Moisture
- Powder Coated in a Tough Scratch Resistance Textured Powder Paint

Red
 SKU 547124
 MTZAG-XL4500R

Green
 SKU 547122
 MTZAG-XL450LG



36" 6 Drawer Lower Cabinet

- 36" (W) x 18-3/8" (D) x 40-3/4" (H) (w/ Casters)
- Cubic Inches: 12,388
- Powder Coated in a Tough Scratch Resistance Textured Powder Paint
- Drawers - (4) 2.5", (1) 5.5", (1) 8.5"
- Embossed Stainless Steel Work Surface

Red
 SKU 547123
 MTZRR3606TCPR

Green
 SKU 547126
 MTZRR3606TCLG

Lift Gate Service
 SKU 301610
 MTZLIFTGATE **100⁰⁰**



36" Upper Chest - Black

- 16 Gauge Steel Construction, Welded Seams, No Spot Welding
- 36" x 18" x 21" with Pegs, Slots and Holes for Organizing All Your Tools
- Weather Stripping Creates a Tight Seal Against Dust and Moisture
- Powder Coated in a Tough Scratch Resistance Textured Powder Paint

36" 6 Drawer Lower Cabinet - Black
 SKU 850535
 24572 **499⁹⁹**

- 36" (W) x 18-3/8" (D) x 40-3/4" (H) (w/ Casters)
- Cubic Inches: 12,388
- Powder Coated in a Tough Scratch Resistance Textured Powder Paint
- Drawers - (4) 2.5", (1) 5.5", (1) 8.5"
- Embossed Stainless Steel Work Surface

Lift Gate Service
 SKU 295540
 OEMLIFTGATE **80⁰⁰**



VALUE: Welded Steel Construction, Stiffeners, Reinforced Stress Points, Heavy Duty Casters and Drawer Slides All with the Most Competitive Pricing in the Market

PRIDE OF OWNERSHIP: The High Quality Powder Coat Finish, Attention to Detail and Smooth Rolling Drawers Gives You Tool Storage You Can Brag About to Your Friends and Co-Workers

SECURITY: Tubular Locks and Heavy Duty Locking Mechanism Keep Your Tools Secure

ORGANIZATION: Pick the Combination and Drawer Design to Fit You. A Properly Organized Box Helps You Work Faster and Keep Up with Your Tools

Free Delivery! in 48 Continental United States | **Specifications Subject to Change Without Notice or Liability.** Prices Do Not Include Vehicles, Installation or Optional Equipment as Shown. | **Customers Responsible for Off-Loading Equipment Upon Arrival.** Ask Your Sales Rep for Details. | ***Leasing Terms Available.** Ask Your AutoZone® Commercial Sales Manager.

SAVE \$199⁹⁹ ON A COMBO PURCHASE

10 Drawer Top Chest: \$699.99
16 Drawer Cabinet: \$1,199.99
Total: \$1,899.98
TOTAL SAVINGS: \$199.99

OEM TOOLS

72" 26 Drawer Chest and Cabinet Combo

- Raise and Release Drawer Latches
- Full Extension 100 Lbs. Capacity Slides
- Gas Struts for Easy Opening
- Drawer Liners Included
- 1.0 mm Steel Shell
- 0.8 mm Drawers
- Dimensions: 72" x 20" x 63" (W x D x H)

1,699⁹⁹



Red
SKU OUTSIDE BUY/EPO | 24587



Gun Metal Gray
SKU OUTSIDE BUY/EPO | 24626



Blue
SKU OUTSIDE BUY/EPO | 24629

Available via Outside Buy/EPO, Call (1-877-298-6651) for details.

Lift Gate Service
SKU 295540
OEMLIFTGATE **80⁰⁰**

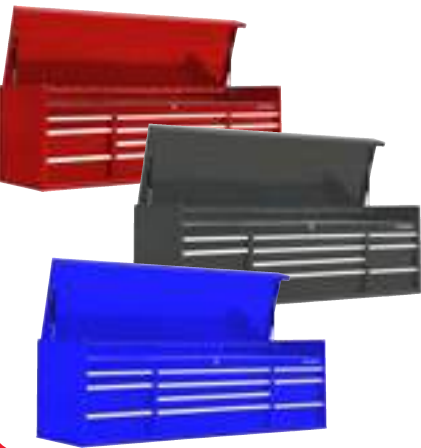

72" 10 Drawer Top Chest

SKU OUTSIDE BUY/EPO

699⁹⁹

- Dimensions: 72" x 19.7" x 22" (W x D x H)

Red
SKU OUTSIDE BUY/EPO | 24585

Gun Metal Gray
SKU OUTSIDE BUY/EPO | 24624

Blue
SKU OUTSIDE BUY/EPO | 24627

Available via Outside Buy/EPO, Call (1-877-298-6651) for details.

Lift Gate Service
SKU 295540
OEMLIFTGATE **80⁰⁰**

72" 16 Drawer Cabinet

SKU OUTSIDE BUY/EPO

1,199⁹⁹

- Dimensions: 72" x 20" x 41" (W x D x H)

Red
SKU OUTSIDE BUY/EPO | 24586

Gun Metal Gray
SKU OUTSIDE BUY/EPO | 24625

Blue
SKU OUTSIDE BUY/EPO | 24628

Available via Outside Buy/EPO, Call (1-877-298-6651) for details.



SAVE \$99⁹⁹ ON A COMBO PURCHASE

36" 10 Drawer Chest and Cabinet Combo - Black/Green

SKU OUTSIDE BUY/EPO 24593

799⁹⁹

- Raise and Release Drawer Latches to Secure Drawers
- Flat Key Locking System
- EVA Drawer Liners Included
- 4 Large Sturdy 5" x 2" Mag Casters
- Dimensions: 36.7" x 18.1" x 61" (W x D x H)

Available via Outside Buy/EPO, Call (1-877-298-6651) for details.

Offers Good Thru September 30, 2016
While Supplies Last



10 Drawer Top Chest: \$399.99
16 Drawer Cabinet: \$499.99
Total: \$899.98
TOTAL SAVINGS: \$99.99

36" 4 Drawer Top Chest - Black/Green

SKU OUTSIDE BUY/EPO 24591

399⁹⁹

- Dimensions: 36.7" x 18.1" x 21.2" (W x D x H)

Available via Outside Buy/EPO, Call (1-877-298-6651) for details.



36" 6 Drawer Roller Cabinet - Black/Green

SKU OUTSIDE BUY/EPO 24592

499⁹⁹

- Dimensions: 36.7" x 18" x 39.8" (W x D x H)

41" 16 Drawer Chest and Cabinet Combo - Black/Green

SKU OUTSIDE BUY/EPO 24596

999⁹⁹

- Raise and Release Drawer Latches
- Full Extension 100 Lbs. Capacity Slides
- Gas Struts for Easy Opening
- Drawer Liners Included
- Dimensions: 41" x 18.1" x 61" (W x D x H)

Available via Outside Buy/EPO, Call (1-877-298-6651) for details.

Offers Good Thru September 30, 2016
While Supplies Last



6 Drawer Top Chest: \$499.99
10 Drawer Cabinet: \$599.99
Total: \$1,099.98
TOTAL SAVINGS: \$99.99

41" 6 Drawer Top Chest - Black/Green

SKU OUTSIDE BUY/EPO 24594

499⁹⁹

- Dimensions: 41" x 18.1" x 21.2" (W x D x H)

Available via Outside Buy/EPO, Call (1-877-298-6651) for details.



41" 10 Drawer Roller Cabinet - Black/Green

SKU OUTSIDE BUY/EPO 24595

599⁹⁹

- Dimensions: 41" x 18.1" x 39.8" (W x D x H)

TOOL STORAGE



Contact Us:
1-877-AZTool1 Phone
 (1-877-298-6651) *Hablamos Español*

CLASSIC SERIES

- Perfect for Startup Or Experienced Pro, You Can Rely On These Classics for Years
- Easily Load Up Your Draws and Still Maneuver Your Storage Combo to Your Project
- Ball Bearing Full Extension, 100 Lbs. Capacity Drawer Slides
- Dual Sets of Drawer Slides On Larger Drawers
- Gas Struts On Lids for Easy Opening

46" 10 Drawer Cabinet and Upper Cabinet - Stainless Steel
 KU OUTSIDE BUY/EPO 24617 **799⁹⁹**

- Black Aluminum Drawer Pulls
- Full Extension 100 Lbs. Capacity Slides
- Drawer Liners Included
- Dimensions: 46" x 18" x 71.5" (W x D x H)
- PVC Coated MDF Top
- Stainless Steel



41" 19 Drawer Chest and Cabinet Combo - Black
 SKU OUTSIDE BUY/EPO 24584 **999⁹⁹**

- Raise and Release Drawer Latches
- Full Extension 100 Lbs. Capacity Slides
- Gas Struts for Easy Opening
- Drawer Liners Included
- 0.8 mm Steel Shell
- Dimensions: 41.5" x 18" x 62.5" (W x D x H)

Available via Outside Buy/EPO, Call (1-877-298-6651) for details.



41" 8 Drawer Top Chest - Black
 SKU OUTSIDE BUY/EPO 24582 **399⁹⁹**

- Dimensions: 41" x 17.8" x 22.4" (W x D x H)



41" 11 Drawer Roller Cabinet - Black
 SKU OUTSIDE BUY/EPO 24583 **599⁹⁹**

- Dimensions: 41.6" x 18" x 41.3" (W x D x H)



46" 10 Drawer Cabinet - Stainless Steel
 SKU OUTSIDE BUY/EPO 24614 **599⁹⁹**

- Black Aluminum Drawer Pulls
- Full Extension 100 Lbs. Capacity Slides
- Drawer Liners Included
- Dimensions: 46" x 18" x 35.5" (W x D x H)
- PVC Coated MDF Top
- Stainless Steel



Available via Outside Buy/EPO, Call (1-877-298-6651) for details.

Lift Gate Service
 SKU 295540 OEMLIFTGATE **80⁰⁰**

56" 18 Drawer Chest and Cabinet Combo - Black
 SKU OUTSIDE BUY/EPO 24581 **1,299⁹⁹**

- Raise and Release Drawer Latches
- Full Extension 100 Lbs. Capacity Slides
- Gas Struts for Easy Opening
- Drawer Liners Included
- 0.8 mm Shell and Drawers
- Dimensions: 55.9" x 20" x 62.7" (W x D x H)

Available via Outside Buy/EPO, Call (1-877-298-6651) for details.



56" 7 Drawer Top Chest - Black
 SKU OUTSIDE BUY/EPO 24579 **549⁹⁹**

- Dimensions: 55.4" x 19.8" x 22.4" (W x D x H)



56" 11 Drawer Roller Cabinet - Black
 SKU OUTSIDE BUY/EPO 24580 **899⁹⁹**

- Dimensions: 56" x 20" x 41.3" (W x D x H)



SAVE \$149⁹⁹ ON COMBO

ELITE SERIES

- Pride of Ownership. You've Earned It.
- Dual Sets of Drawer Slides On Larger Drawers
- The Elite Series Speaks to the Professional Who Wants a Superior Storage Solution

OEM TOOLS

72" 11 Drawer Cabinet, with 3 Door Upper Cabinet - Stainless Steel
 SKU OUTSIDE BUY/EPO | 24615 **1,099⁹⁹**

- Dimensions: 72" x 18" x 71.5" (W x D x H)
- Pegboard Is 18" Tall
- Upper Cabinet Is 12" x 18" (H x D)

Lift Gate Service
 SKU 295540 OEMLIFTGATE **80⁰⁰**



Available via Outside Buy/EPO, Call (1-877-298-6651) for details.

- Black Aluminum Drawer Pulls
- Full Extension 100 Lbs. Capacity Slides
- Drawer Liners Included
- Dimensions: 72" x 18" x 71.5" (W x D x H)
- Upper Cabinet Is 12" x 18" (H x D)
- Pegboard Is 18" Tall
- PVC Coated MDF Top
- Stainless Steel

Add Maximum Storage Space to Your Garage or Work Station. This Stainless Steel Tool Box System Looks Modern and Clean. Helps You Stay Organized and Expands Your Work Space.

OEM TOOLS

72" Hutch - Black
 SKU OUTSIDE BUY/EPO | 24578 **899⁹⁹**

- Dimensions: 72" x 30" x 26.3" (W x D x H)

72" Elite 17 Drawer Roller Cabinet - Black
 SKU OUTSIDE BUY/EPO | 24577 **2,999⁹⁹**

- Dimensions: 72" x 30" x 44.2" (W x D x H)



Available via Outside Buy/EPO, Call (1-877-298-6651) for details.

- Welded Steel Construction
- Powder Coated Finish with MDF Top
- 6" Heavy Duty Spring-Loaded Casters
- Keyed Locking System with Tubular Locks to Keep Your Tools Secure
- 250 Lbs. Ball Bearing Drawer Slides
- Raise and Release Drawer Latches to Secure Drawers
- Comes in Wooden Crate On Pallet with Casters Installed

Lift Gate Service
 SKU 295540 OEMLIFTGATE **80⁰⁰**

Free Delivery!
 in 48 Continental United States

Specifications Subject to Change Without Notice or Liability.
 Prices Do Not Include Vehicles, Installation or Optional Equipment as Shown.

Customers Responsible for Off-Loading Equipment Upon Arrival.
 Ask Your Sales Rep for Details.

***Leasing Terms Available.**
 Ask Your AutoZone® Commercial Sales Manager.

SIGNATURE SERIES

- Form, Function and Style All in Your Tool Box Storage
- Top Shelf Performance at a Reasonable Cost
- Contour Design and Heavy Duty 19 Gauge Steel Construction
- Tubular Locks Keep Your Tools Secure
- Ball Bearing Full Extension, 100 Lbs. Capacity Drawer Slides
- Dual Sets of Drawer Slides On Larger Drawers

SAVE \$99.99 ON A COMBO PURCHASE

OEM TOOLS

41" 10 Drawer Contour Chest and Cabinet Combo

999⁹⁹

- 10 Drawers with Full Extension 100 Lbs. Capacity Slides for Easy Access
- Patented Raise and Release Drawer Latches to Secure Drawers
- EVA Drawer Liners Included
- 4 Sturdy 5" x 1.5" Tire Style Casters with Wheel Locks
- Gas Struts On Lids for Easy Opening
- One Stainless Steel Handle On Cabinet
- Double Drawer Slides On Larger Drawers
- Dimensions: 41" x 18" x 60.4" (W x D x H)

Available via Outside Buy/EPO, Call (1-877-298-6651) for details.

Race Blue with White Stripes
SKU OUTSIDE BUY/EPO | 24590



Orange with White Stripes
SKU OUTSIDE BUY/EPO | 24620



Green and Matte Black
SKU OUTSIDE BUY/EPO | 24623



Offer Good Through September 30, 2016 - While Supplies Last



41" 4 Drawer Contour Top Chest
499⁹⁹

Race Blue with White Stripes
SKU OUTSIDE BUY/EPO | 24588

Orange with White Stripes
SKU OUTSIDE BUY/EPO | 24618

Green and Matte Black
SKU OUTSIDE BUY/EPO | 24621

Available via Outside Buy/EPO, Call (1-877-298-6651) for details.

41" 6 Drawer Contour Cabinet
599⁹⁹

Race Blue with White Stripes
SKU OUTSIDE BUY/EPO | 24589

Orange with White Stripes
SKU OUTSIDE BUY/EPO | 24619

Green and Matte Black
SKU OUTSIDE BUY/EPO | 24622

Available via Outside Buy/EPO, Call (1-877-298-6651) for details.



Lift Gate Service
SKU 295540
OEMLIFTGATE **80⁰⁰**

TRADE SERIES

- Dedicated to the Skilled Worker, the Trade Series Is Perfect for the Home or DIY Storage Solution
- Offered in a Variety of Sizes and Drawer Combinations to Meet Any Need
- Ball Bearing Full Extension, 100 Lbs. Capacity Drawer Slides
- Dual Sets of Drawer Slides on Larger Drawers
- Reinforced Steel Frame Supports Heavy Storage

26" 12 Drawer Chest and Cabinet Combo - Blue

SKU OUTSIDE BUY/EPO | 24599 **499⁹⁹**

- Aluminum Drawer Pulls
- Full Extension 100 Lbs. Capacity Slides
- Gas Springs for Easy Opening
- Drawer Liners Included
- 0.8 mm Steel Shell
- Dimensions: 26.5" x 18.3" x 52.4" (W x D x H)

Lift Gate Service
SKU 295540
OEMLIFTGATE **80⁰⁰**

Available via Outside Buy/EPO, Call (1-877-298-6651) for details.

26" 6 Drawer Top Chest - Blue
SKU OUTSIDE BUY/EPO | 24597 **199⁹⁹**

- Dimensions: 26.22" x 12.01" x 14.06" (W x D x H)

26" 6 Drawer Cabinet - Blue
SKU OUTSIDE BUY/EPO | 24598 **299⁹⁹**

- Dimensions: 26.5" x 18.3" x 37.91" (W x D x H)



41" 13 Drawer Chest and Cabinet Combo - Blue

SKU OUTSIDE BUY/EPO | 24613 **699⁹⁹**

- Includes Sturdy (4) 5" x 2" Casters (2 Swivel with Brakes and 2 Rigid)
- Dual Gloss and Hammer Tone Powder Coat Finish Resists Rust
- Side Handles On Top Chest and Molded Handle On Cabinet for Mobility
- EVA Drawer Liners Keep Tools in Place
- Dimensions: 41.4" x 16" x 56.6" (W x D x H)

SAVE \$99⁹⁹ ON COMBO

Available via Outside Buy/EPO, Call (1-877-298-6651) for details.

41" 8 Drawer Top Chest - Blue
SKU OUTSIDE BUY/EPO | 24611 **349⁹⁹**

- Dimensions: 40.55" x 20" x 18.7" (W x D x H)

41" 5 Drawer Cabinet - Blue
SKU OUTSIDE BUY/EPO | 24612 **449⁹⁹**

- Dimensions: 41.4" x 16" x 37.91" (W x D x H)



Service Trays

29" Portable Tear Down Trays

- Adjustable Table Height: 33-1/2" to 49-1/4"
- Total Weight Capacity: 55 Lbs.
- EVA Foam Work Surface Liners
- 29.1" x 20.1" Work Surface
- Rubber Bumper Corners

SKU 512947
24960 Black
79⁹⁹



SKU 850045
24616 Green
79⁹⁹



Adjustable Height

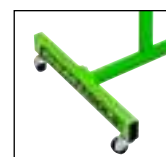

Portable



Divider Tray with EVA Liners

OEM TOOLS

TOOL STORAGE

SAVE BIG ON OEMTOOLS® SETS



SAVE \$549⁹⁹

Tool Set Savings: \$200.00
 Bonus Tool Cart: \$349.99
TOTAL SAVINGS: \$549.99



167 Piece Mechanic's Set

SKU 533204 | Part# 24974

BONUS
5 Drawer Service Cart
 SKU 512950 | Part# 24963
VALUE: \$349.99

with Purchase of:
167 Piece Mechanic's Set
 SKU 533204 | Part# 24974



799⁹⁹
 REG: \$999.99

Professional Quality Tools

This set includes 167 of the most common tools used by technicians. All in a great looking 5 drawer cart.

Includes:

- 1/4", 3/8" and 1/2" Drive Tools
- Hand Tools
- Battery Service Tools
- Oil Change Tools
- And More



Items Subject to Change.

Offers Good Thru September 30, 2016 While Supplies Last

SAVE \$649⁹⁹

Tool Set Savings: \$350.00
 Bonus Tool Cart: \$299.99
TOTAL SAVINGS: \$649.99



160 Piece Lube Tech Starter Set

SKU 227302 | Part# 24965

BONUS
4 Drawer Service Cart
 SKU 512949 | Part# 24962
VALUE: \$299.99

with Purchase of:
160 Piece Lube Tech Starter Set
 SKU 227302 | Part# 24965



999⁹⁹
 REG: \$1,349.99

Professional Quality Tools

160 of the most popular tools used by lube techs.

Includes:

- Hand Tools
- Battery and Tire Service Tools
- Battery Service Tools
- Specialty Oil Filter Wrenches to Service Late Model Cars and Trucks



Items Subject to Change.

Offers Good Thru September 30, 2016 While Supplies Last

SAVE \$899⁹⁹

Tool Set Savings: \$550.00
 Bonus Tool Cart: \$349.99
TOTAL SAVINGS: \$899.99



312 Piece Technician's Set

SKU 533203 | Part# 24975

BONUS
5 Drawer Service Cart
 SKU 512950 | Part# 24963
VALUE: \$349.99

with Purchase of:
312 Piece Technician's Set
 SKU 533203 | Part# 24975



1,349⁹⁹
 REG: \$1,899.99

Professional Quality Tools

This set includes 312 of the most common tools used by technicians. All in a great looking 5 drawer cart.

Includes:

- 1/4", 3/8" and 1/2" Drive Tools
- Hand Tools
- Battery Service Tools
- Oil Change Tools
- And More



Items Subject to Change.

Offers Good Thru September 30, 2016 While Supplies Last

SAVE \$949⁹⁹

Tool Set Savings: \$600.00
 Bonus Tool Cart: \$349.99
TOTAL SAVINGS: \$949.99



350 Piece Apprentice Starter Set

SKU 227300 | Part# 24964

1,899⁹⁹
 REG: \$2,499.99

Professional Quality Tools

We have used our years of experience in the tool business to develop a tool set that includes the most popular hand and air tools. This set includes 350 of the most common tools used by technicians.

Includes:

- 1/4", 3/8" and 1/2" Drive Tools
- Air Tools
- Hand Tools
- Brake Service Tools
- Battery Service Tools
- Oil Change Tools
- Tire Tools
- And More



BONUS
5 Drawer Service Cart
 SKU 512950 | Part# 24963
VALUE: \$349.99

with Purchase of:
350 Piece Apprentice Starter Set
 SKU 227300 | Part# 24964

Items Subject to Change.

Offers Good Thru September 30, 2016 While Supplies Last



Contact Us:
1-877-AZTool1 Phone
 (1-877-298-6651) *Hablamos Español*

Service Carts

Hi-Impact Structural Polypropylene Service Carts (500 Lbs. Capacity)

Standard Service Cart

SKU 751723 **79⁹⁹**
 24957 REG. \$99.99

SAVE \$20

• Cart Dimensions: 33-5/8" x 17-5/16" x 40-3/8" (H x W x L)

Large Service Cart

SKU 751722 **99⁹⁹**
 24958 REG. \$129.99

SAVE \$30

• Cart Dimensions: 33-2/3" x 25-3/4" x 46-7/8" (H x W x L)



OEM TOOLS

- Stands Up to Rugged Use
- (2) Large 3" Deep Trays Keep Load Secure While Transporting
- Easy Assembly
- Heavy Duty Polypropylene Is Easy to Clean, Resistant to Rust, Denting and Chipping
- Maximum Weight Carrying Capacity of 500 Lbs. (250 Lbs. per Shelf)
- Smooth Rolling, Non-Marring 5" Casters



Offers Good Thru September 30, 2016 - While Supplies Last

OEM TOOLS

2 Tray Service Cart

SKU 432099 **119⁹⁹**
 24959

- 4" Swivel Casters: (2) Locking and (2) Standard
- Dimensions: 30" (W) x 16" (D) x 35.3" (H)
- Load Capacity: 350 Lbs.



Service Cart with Locking Lid and Drawer

SKU 512948 **149⁹⁹**
 24961

- Easy to Maneuver with (4) Swivel Casters: (2) Standard and (2) Locking
- Stays Securely in Place with (2) Locking Casters
- Total Load Capacity: 350 Lbs.
- Drawer Load Capacity: 75 Lbs.
- Full Length Aluminum Drawer Handles
- Chrome Tube Leg
- Durable Powder Coating Finished
- Ball Bearing Slides
- 30" (H) x 18" (D) x 30" (L)



RAISE AND RELEASE DRAWER LATCHES

Deluxe 4 Drawer Service Cart

SKU 512949 **299⁹⁹**
 24962

- Stays Securely in Place with (2) Locking Casters
- Lockable Side Has 26 Slots for Extra Storage
- Total Load Capacity: 500 Lbs.
- Dimensions: 30" (H) x 18" (D) x 49" (L) (with Tray Extended)



RAISE AND RELEASE DRAWER LATCHES

SKU OUTSIDE BUY/EPO 24570 Green

Available via Outside Buy/EPO, Call (1-877-298-6651) for details.

Deluxe 5 Drawer Service Cart

SKU 512950 **349⁹⁹**
 24963 Black

- Lockable Side Has 26 Slots for Extra Storage
- Total Load Capacity: 500 Lbs.
- Drawer Loading Capacity: 75 Lbs.
- Chrome Tube Legs
- 31" (H) x 18" (D) x 49" (L) (with Tray Extended)



LOCKING LEVER
 Inside Lever Locks Drawers to Prevent Sliding While Cart Is in Motion

RAISE AND RELEASE DRAWER LATCHES

Socket Organizers

ERNST
 MANUFACTURING INC.

Socket Boss - 2 Rail Socket Tray (3/8" Drive)

SKU 255123 **24⁹⁹**
 ERN8453

- Holds (30) Sockets
- Twist-Lock Clips Keep Sockets Secured



Socket Boss - 3 Rail Socket Tray (1/4", 3/8", 1/2" Drive)

- Holds (45) Sockets in Three Drive Sizes
- Push Button Release to Remove Any Rail

Red SKU 255105 **29⁹⁹**
 ERN8450

Blue SKU 255120 **29⁹⁹**
 ERN8451



Dura-Pro Twist-Lock Cart Mount Socket System (3/8" Drive)

SKU 255131 **34⁹⁹**
 ERN8466

- Holds (30) Sockets and (4) Ratchets or Extensions
- Just a Simple 1/8th Turn and Your Tools Are Secured

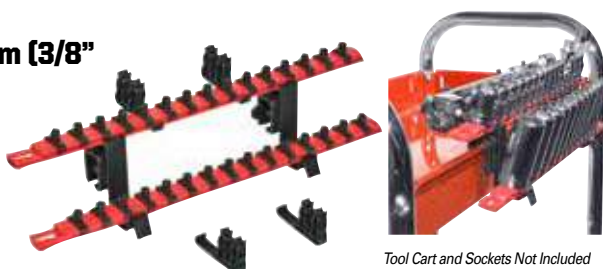

Tool Cart and Sockets Not Included

Complete Tool Organizing System with Twist-Lock Socket Clips

SKU 255094 **69⁹⁹**
 ERN8480

- 1/4", 3/8" and 1/2" Drive
- Makes Your Tools Easy to Find
- Holds (126) Wrenches, Screwdrivers, Sockets, Ratchets and Extensions

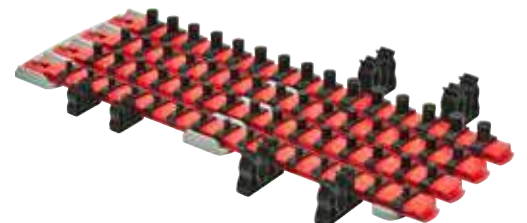

Work Stand

STECK

Pro Step Adjustable Work Stand

SKU 222856 **164⁹⁹**
 STK20350

- Height Adjustable from 6-1/2" to 22-1/2"
- Capacity: 500 Lbs.
- 32" x 16"
- Foam Bumpers Protect Vehicle Finish
- Spring-Loaded Retractable Wheels - You Can Push It with Your Foot, Stays Put When a Load Is Present
- Extra-Wide 23" Base Rails for Stability
- Heavy Duty (Weight: 45 Lbs.) Construction



Trays and Racks

Plier/Wrench Rack

- Will Hold Up to (13) Tools
- (2) Different Size of Slots to Accommodate All Sizes of Tools
- 11" (W) x 7" (H) x 2" (D)

Red SKU 255888 **22⁹⁹**
 LIS40490

Black SKU 255882 **22⁹⁹**
 LIS40460

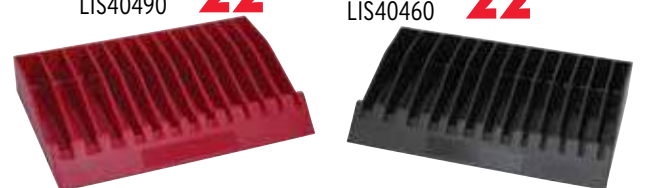

Liste

Magnetic Trays

10" x 11" Magnetic Tray

SKU 965835 **24⁹⁹**
 25119

- (4) Powerful Magnets with Protective Rubber Coating to Resist Scratching
- Strong and Durable to Collect Small Parts, Fasteners and Tools
- Heavy Duty Stainless Steel



OEM TOOLS
 Ideal for Holding Small Parts and Tools

Tools Not Included

AIR CONDITIONING

Recovery Machines

MAHLE



**CONTACT US FOR
FACTORY SETUP
AND TRAINING**
1-877-AZTool1
(1-877-298-6651)



Hybrid Ready

R134a A/C Refrigerant Handling System

SKU 850570
MSSACX1120H **2,799⁹⁹**

- ECO LOCK® Quick Couplers Designed for Servicing All Passenger Cars, Trucks and Hybrid Vehicles
- High Performance Vacuum Pump to Ensure Faster Service Times

All MAHLE Recovery Machines are Fully Automatic and Include a 2 Year Warranty

MAHLE

Fully Automatic
2 Year Warranty



R134a A/C Refrigerant Handling System

SKU 850573
MSSACX1150 **3,399⁹⁹**

- 4.3" Color TFT Touchscreen
- ECO LOCK® Quick Couplers
- High Performance Vacuum Pump to Ensure Faster Service Times
- Automatic Oil Injection and Measurement

MAHLE

Fully Automatic
2 Year Warranty



Hybrid Ready

R134a A/C Refrigerant Handling System

SKU 850571
MSSACX1150H **3,399⁹⁹**

- Hybrid Function. Designed for Servicing All Passenger Cars, Trucks and Hybrid Vehicles
- 4.3" Color TFT Touchscreen
- ECO LOCK® Quick Couplers
- High Performance Vacuum Pump to Ensure Faster Service Times

MAHLE

Fully Automatic
2 Year Warranty



R134a ArticPro Refrigerant Handling System

SKU 850566
MSSACX1180 **3,849⁹⁹**

- Completely Recover, Recycle or Recharge R134a Air Conditioning Systems
- Quicker Service Times
- Automatic Air Purge
- Fully Automatic

MAHLE

Fully Automatic
2 Year Warranty

Hybrid Ready



R134a ArticPro Refrigerant Handling System

SKU 850567
MSSACX1180H **3,899⁹⁹**

- Completely Recover, Recycle or Recharge R134a Air Conditioning Systems
- Hybrid Ready

MAHLE

Fully Automatic
2 Year Warranty



R1234YF ArticPro Refrigerant Handling System Hybrid with Printer and Identifier

SKU 850569
MSSACX1280 **5,699⁹⁹**

- Completely Recover, Recycle or Recharge R1234YF Air Conditioning Systems in Conventional and Hybrid Vehicles
- Fully Automatic
- Quicker Service Times
- Automatic Air Purge

A/C Refrigerant Recovery and Recycling Station Filter Kit for RTI and Mahle

SKU 818739
RTI3608213300 **119⁹⁹**



- Includes All Needed Items to Perform Basic Maintenance On Your RTI and Mahle Recovery Machine. RTI Filters Need to Be Replaced Every 150 Lbs. of Use in Order to Properly Remove

Acids and Moisture That Can Damage Compressors and Contaminate Oil in the Vehicle. DO NOT Accept Look Alike or Knock Off Filters. You Should Change the Filter-drier When Notified

by Machine to Assure Adequate Moisture and Contaminant Removal as Well as Prevent Lockout at 150 Lbs. of Use.



Recovery Machines

cps

Dual Gas Recovery/Recycle/Recharge Machine with Printer

SKU 850572
CPSFX3030 **7,119⁹⁹**

- Convertible Between R134a and R1234yf
- Built-In Refrigerant Identifier
- Vehicle Refrigerant Capacity Database Included
- Includes 2 Tanks and 2 Sets of Hoses
- 1-2-5 Warranty



Hybrid Ready
Dual Gas

1234YF Recovery/Recycle/Recharge with Printer

SKU 850568
CPSFX1234 **6,699⁹⁹**

- Patented Oil-Less Compressor
- 6 CFM Vacuum Pump/ 50 Micron Rated
- Patented Motor-Controlled Ball Valves
- AC Systems Capacity Database Included
- 1-2-5 Warranty



Hybrid Ready

cps

R134a Refrigerant/Recover/Recharge Machine with Printer

SKU 695135
CPSFX134A **3,999⁹⁹**

- On Board Vehicle A/C Data: 1994-2015
- 10 Ft. Charging Hoses
- 6 CFM Vacuum Pump
- Heater Blanket Included
- 1-2-5 Warranty



Hybrid Ready

cps

Convert-Able Multi Refrigerant Recover/Recycle/Recharge Machine

SKU 452639
CPSFA1234 **3,719⁹⁹**

- Recovery Recycling Recharging Machine That Can Be Used with R-134a or HFO-1234yf
- Ships Prepared for 134a and Can Be Used for Either 134a or HFO-1234yf Gas
- Will also Work with R22 and R407C for Reefers
- High Performance Two Stage 6 CFM Vacuum Pump
- Standard Equipment Includes 8 Ft. Hoses, R-134a Couplers, HFO-1234yf Couplers, R-134a Tank Refill Adapter



Hybrid Ready
Dual Gas

AR2788/2788S Recovery Machine Filter

SKU 186483
CPSARXF5 **89⁹⁹**



- Required to Clean The Refrigerant Before Putting Back into the Vehicle
- Design for Use on the AR2788S

- Filter Removes Moisture and Contaminants Before the Refrigerant is Returned to the System

cps

Recovery Machines

Mastercool
"World Class Quality"

Automatic R134a Recovery, Recycle and Recharge Machine

SKU 300784
MSC69788-A **2,999⁹⁹**

- Certified for Compliance with SAE J2788
- Large Display: 4.8"
- Vacuum Pump: 6 CFM
- Bottle Heater: Standard Equipment
- Includes Upgradeable Refrigerant Capacity Database
- 1 Year Warranty



Fully Automatic R134a Recovery, Recycle, Recharge Station

SKU 300780
MSC69789 **3,399⁹⁹**

- Automatic, Programmable with Manual Modes
- Compressor: Hermetically Sealed, 12 cc
- Vacuum Pump: 6 CFM, 100 Liter/Min. Capacity
- Bottle Temperature Sensor: Integrated
- Includes Upgradeable Refrigerant Capacity Database
- 1 Year Warranty



Fully Automatic R134a and Hybrid Recovery, Recycle, Recharge Station

SKU 295555
MSC69789-H **3,699⁹⁹**

- Automatic, Programmable with Manual Modes
- Auto Oil Discharge
- Vacuum Pump: 6 CFM
- High Voltage Protection
- Includes Upgradeable Refrigerant Capacity Database
- 1 Year Warranty

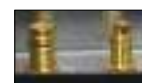

69789-H Features Refrigerant Oil Flush System



Mastercool
"World Class Quality"

Reduce Down Time...
Keep an Extra Filter Set On Hand!

Replacement High/Low Filter Set

SKU 389222
MSC69788FLTpk **139⁹⁹**

- Replacement Filter Pack Kit for Mastercool's MSC69788-A, MSC69789 and MSC69789-H Recharge-Recover-Recycle All-in-One Units



BONUS

Offers Good Through September 30, 2016
While Supplies Last

Infrared Thermometer
VALUE: \$34.80



Part# 252219

with Purchase of a:
R134a Recovery, Recycle and Recharge Machine

SKU 300780 | Part# MSC69789 or SKU 300784 | Part# MSC69788-A or
SKU 295555 | Part# MSC69789-H

Shipping Not Included. Manufacturer's Coupon Must Be Completed for Bonus

Leasing Terms Available!†

Ask Your AutoZone®
Commercial Sales Manager

AutoZone®
Tool & Equipment QUARTERLY

Portable Recovery Systems



Portable R134a Recovery System

SKU 290024 **1,369⁹⁹**
MSC69100

- High Performance Oil-Less Compressor
- Includes an Oil Separator and Filter Dryer to Clean Refrigerant During Recovery
- Recovers All Refrigerants, 30 Lbs. DOT Recovery Tank Included



Portable A/C Recovery Machine

SKU 504026 **1,499⁹⁹**
CPSTRA21

- SAEJ2810 Approved Fastest Recovery Recycle Machine in the Industry Oil Separator and Filter Includes 30 Lbs.
- Tank and Manifold Set with 60" Hoses and Manual Couplers



Vacuum Pump Kits



A/C Service Set with Air Vacuum Pump - R134a

SKU 850564 **99⁹⁹**
68991

- Complete Kit for Diagnosing and Charging R134a A/C Systems
- Includes Air Vacuum Pump with 1/2" Acme R134a and R12 Connectors, Brass Manifold Gauge Set with 60" Hoses and Snap Style Couplers, Brass Can Tap Valve and Large Diameter Dual Scale Thermometer



A/C Starter Kit - R134a

SKU 695127 **179⁹⁹**
68987

Kit Includes:

- OEM 1.8 CFM, 100 Micron Single Stage Vacuum Provides Fast, Thorough Evacuation and Provides Powerful, Quiet, High Vacuum Capability, Ensures Moisture Removal and Reduces Evacuation Time
- OEM Professional Quality Extruded Aluminum Manifold with Sight Glass, 72" Hoses, High Quality Manual Couplers and Easy-to-Read Spring Dampened Gauges to Reduce Flutter
- OEM R134a Can Tap Connects to Any Acme Threaded R134a Can



3 Piece High Performance A/C Kit

SKU 626121 **249⁹⁹**
68989

Kit Includes:

- OEM 6 CFM, 75 Micron Single Stage Vacuum Provides Fast, Thorough Evacuation. and Provides Powerful, Quiet, High Vacuum Capability, Ensures Moisture Removal and Reduces Evacuation Time.
- OEM Professional Quality Extruded Aluminum Manifold with Sight Glass, 72" Hoses, High Quality Manual Couplers and Easy To Read Spring Dampened Gauges To Reduce Flutter
- OEM 3 in 1 Can Tap Fits 1 Lbs. Cans of R134a, R12 and 2" Oil Charge Cans and Includes 1/2" ACME Male and 1/4" FL - Male Ports



A/C Professional Set - R134a

SKU 695129 **299⁹⁹**
68988

Kit Includes:

- OEM 4 CFM, 75 Micron Single Stage Vacuum Provides Fast, Thorough Evacuation. and Provides Powerful, Quiet, High Vacuum Capability, Ensures Moisture Removal and Reduces Evacuation Time
- OEM Professional Quality Extruded Aluminum Manifold with Sight Glass, 72" Hoses, High Quality Manual Couplers and Easy To Read Spring Dampened Gauges To Reduce Flutter
- OEM 3 in 1 Can Tap Fits 1 Lbs. Cans of R134a, R12 and 2" Oil Charge Cans and Includes 1/2" ACME Male and 1/4" FL - Male Ports
- OEM AC Refrigerant Leak Detector is Sensitive to 0.1 Oz./Year and Responds to All Halogenated Refrigerants

A/C Recycle Guard Accessories



Recycle Guard R12 Adapter Kit, 1/4 In. Flare

SKU 504086 **39⁹⁹**
AIR72138



Recycle Guard for R134a - 1/2 In. ACME Fittings with 36 In. Service Hose

SKU 504082 **289⁹⁹**
AIR72101

- Protect your recovery equipment from debris, sealant, dye, excess lubricant and other contaminants
- Works with all A/C service equipment



Recycle Guard for 1/4 In. SAE Flare with 36 In. Service Hose

SKU 504083 **289⁹⁹**
AIR72102

- Protect Your Recovery Equipment from Debris, Sealant, Dye, Excess Lubricant and Other Contaminants
- Works with All A/C Service Equipment



Dual Automatic Recycle Guard for R134a with (2) 36 In. Service Hoses

SKU 504091 **439⁹⁹**
AIR75000

- High and low side protection from debris, sealant, dye, excess lubricant and other contaminants For R134a with (2) 36" service hoses



A/C Recovery Machine Accessories

A/C Recovery Machine Vinyl Dust Cover

SKU 291481 **99⁹⁹**
ROB17492

- Medium Gray Color with Cooltech Logo Fits All 342000, 17700-2K, 34700-2K, 34134Z, 34700Z, 34711-2K, AC375, AC375A, 17700Z, 34702Z



A/C Recovery Machine Vinyl Dust Cover

SKU 752708 **129⁹⁹**
ROB17490

- Medium Gray Color with Cool-Tech Logo Fits 34900, 34800-2K, And 17800b Series



Vinyl Dust Cover for A/C Recovery Machine

SKU 751574 **129⁹⁹**
ROB17499

- Protect Your Investment with a Heavy-Duty Vinyl Dust Cover Fits AC1234-6, 34788NI, 34788NI-H Models



A/C Capacities Database - 2014

SKU 804464 **229⁹⁹**
ROB34412

- Use with a Robinair 34788NI and 34788NI-H A/C RRR Machines to Display Charge Amount and Oil Capacities for Vehicles, Model Years 1997-2014



A/C Capacities Database 2014

SKU 752709 **249⁹⁹**
ROB34411-E

- Works with Robinair 34788, 34788-H, and 34988 A/C RRR Machines Includes Charge Amounts and Component Oil Capacities for Vehicle Model Years 1997-2014



Refrigerant Canister Filter™ 1/2 In. Acme

SKU 544562 **54⁹⁹**
AIR72900

- Use Inline Between the Virgin Refrigerant Tank the Tank Fill Hose
- Helps Stop Debris From Entering Your Refrigerant Supply Protects Your Recovery Machine from Tank Debris



Spin-On Filter-Drier

SKU 414883 **69⁹⁹**
ROB34724

- Fits Current Models: ROB34288, ROB34788, ROB34988, ROB34700Z
- Genuine Robinair Spin-On Filter with the Proper Serial Number to Input into Your Machine to Get it Up and Running Again
- High Quality Filter Protects Your Investment
- Easy to Install



Recycling Filter-Drier

SKU 522875 **74⁹⁹**
ROB34430

- For Older 17700A, 34450, 34700 (1997), AC375, AC375A, AC375C, and 34134Z Robinair Recovery Machines



A/C Recovery Machine Maintenance Kit

SKU 752703 **79⁹⁹**
ROB13172

- Contains: One (1) Quick Change Filter-Drier to Be Used On both R-12 and R-134a Stations and One (1) 16 Ounce Bottle of Our Premium High Vacuum Pump Oil
- For Models Using 34724 Filter/Drier - 17700A, 17700-2K, 34700, 34700-2K, 34800, 34800-2K, 34900 Series



AR2788/2788S Recovery Machine Filter

SKU 186483 **89⁹⁹**
CPSARXF5

- Required to Clean The Refrigerant Before Putting Back into the Vehicle
- Design for Use on the AR2788S
- Filter Removes Moisture and Contaminants Before the Refrigerant is Returned to the System

A/C Refrigerant Recovery and Recycling Station Filter Kit for RTI and Mahle

SKU 818739 **119⁹⁹**
RTI3608213300

- Includes All Needed Items to Perform Basic Maintenance On Your RTI and Mahle Recovery Machine. RTI Filters Need to Be Replaced Every 150 Lbs. of Use in Order to Properly Remove Acids and Moisture That Can Damage Compressors and Contaminate Oil in the Vehicle. DO NOT Accept Look Alike or Knock Off Filters. You Should Change the Filter-drier When Notified by Machine to Ensure Adequate Moisture and Contaminant Removal as Well as Prevent Lockout at 150 Lbs. of Use.
- Fits Recycler Model # : ACS 620 and RHS980



Replacement High/Low Filter Set

SKU 389222 **139⁹⁹**
MSC69788FLTPK

- Replacement Filter Pack Kit for Mastercool's MSC69788-A, MSC69789 and MSC69789-H Recharge-Recover-Recycle All-in-One Units



AIR CONDITIONING

Vacuum Pumps

OEM TOOLS

Air-Operated Vacuum Pump

SKU 544730
24533 **29⁹⁹**

- Includes 1/2" ACME (R134a) and R12 Connectors
- Air Pressure Range: 75-180 PSI
- Air Consumption: 4.2 CFM @ 90 PSI
- Vacuum Capacity: 28.3" of Mercury @ 90 PSI



1.8 CFM Single Stage Vacuum Pump

SKU 466312
24500 **99⁹⁹**

- 1/4 HP, 110V Motor
- 100 Microns
- Internal High Volume Cooling Fan for Extended Use
- Inlet Ports: 1/2" ACME - 1/4" Flare
- Oil Capacity: 200 mL, Included



4 CFM Single Stage Vacuum Pump

SKU 466305
24501 **149⁹⁹**

- 1/3 HP, 110V Motor
- 75 Microns
- Internal High Volume Cooling Fan for Extended Use
- Inlet Ports: 1/2" ACME - 1/4" Flare
- Oil Capacity: 330 mL, Included



6 CFM Single Stage Vacuum Pump

SKU 466306
24502 **199⁹⁹**

- 1/3 HP, 110V Motor
- 75 Microns
- Internal High Volume Cooling Fan for Extended Use
- Inlet Ports: 1/2" ACME - 1/4" Flare
- Oil Capacity: 330 mL, Included



Premium Vacuum Pump Oil 1 Quart Bottle

SKU 517580
CPSVPOQ12 **19⁹⁹**

- Compatible with Most Pumps
- Improves the Life of the Pump
- Performance of Your Pump Depends on Regular Service and the Quality and Purity of the Vacuum Pump Oil That You Use



Vacuum Pump Oil (8 oz)

SKU 363429
24399 **9⁹⁹** STORE STOCK

- Improves the Life of the Pump
- Performance of Your Pump Depends On Regular Service and the Quality and Purity of the Vacuum Pump Oil that You Use
- Compatible for Use in Pumps Made by Most Manufacturers



1.5 CFM Single Stage Vacuum Pump

SKU 573206
MSC90059-R **139⁹⁹**

- HP 1/6
- 75 Microns



6 CFM 2 Stage Vacuum Pump

SKU 301619
MSC900662V110 **349⁹⁹**

- 1/3 HP
- 15 Microns



Tube Assortment

OEM TOOLS

Master Orifice Tube Assortment

SKU 851868
24564 **24⁹⁹**

- Covers Most Vehicles that Require Air Conditioning Orifice Tubes
- Includes: GM Black T-Top, Jeep Green-White, Ford Black, Ford Blue, GM White, Ford and Mazda Black, Ford Red, Chrysler Purple T-Top, Volvo Yellow, Ford Brown, GM Yellow, Ford Green and Chrysler Orange



Valve Tools

OEM TOOLS

No Gas Loss A/C Valve Core Remover/Installer

SKU 466321
24529 **49⁹⁹**

- Remove and Install Standard R134a Valve Cores without the Loss of Refrigerant
- Built-In Ball Valve Retains Charge and Allows Access to A/C System
- For 13 mm and 16 mm High and Low Service Ports



Thermometers

OEM TOOLS

Non-Contact Infrared Thermometer

SKU 951642
25245 **31⁹⁹**

- STORE STOCK
- Temp Range: 35° to +365°C, -31° to +689°F
- Distance to Spot Ratio of 8:1
- Laser Pointer



-58 to 300° F Digital Pocket Thermometer

SKU 447147
24351 **25⁹⁹**

- Accurate Readings from -58 to 300° F (±2°) and from -50 to 150° C (±1°)
- Digital Display Will Rotate 180° and Moves Up and Down for Easy Viewing
- Comes with 1.5V Battery



A/C Flush

CPS

A/C Flush Machine

SKU 217370
CPSAFM100 **1,179⁹⁹**

- Air Operated
- 8 Foot Hoses to Reach Any System
- Forward or Reverse Flush Without Changing Hoses
- 2 1/2 Gallon Capacity Tank for Use On Cars and Buses
- Universal Couplers Allows Connection to Virtually All Types of Connections
- Clear Filter Bowl Allows You to See What is Coming Out of the System with a Cleanable Filter



A/C Flush Machine With Dual-Tank

SKU 575282
AIR40001 **1,999⁹⁹**

- Helps Prevent A/C Repair Comebacks
- Performs 15 Minute Flush, 30 Minute Drying Procedure
- Easy, Low-Cost Maintenance
- Both 1234yf and R134a Compatible
- Powered by Shop Air

NEW



A/C Flush Solvent

- Non-Toxic, Quick Evaporating A/C Flush
- Effectively Removes Debris and Sludge from A/C Components
- Solvent-Based, Evaporates Quickly, Leaves No Residue
- Professional Use Only
- Flush Any A/C System



A/C Flush Solvent 1 Gallon

SKU 695653 | MSC91049-128 **49⁹⁹**

A/C Flush 1 Gallon Case of 4 **199⁹⁹**

SKU 695654 | MSC910491284

A/C Flush 32 oz. Bottle **22⁹⁹**

SKU 695650 | MSC91049-32

A/C Flush 6 Pack 32 oz. Bottles **99⁹⁹**

SKU 695652 | MSC91049-32-6

A/C Quick Flush 17 oz. Replacement **24⁹⁹**

SKU 695647 | MSC91050

A/C Quick Flush 17 oz. Replacement 6 Pack **139⁹⁹**

SKU 695649 | MSC91050-6

A/C System Flush Kit

SKU 466308
24515 **49⁹⁹**

- Use with MSC91049 A/C Flush Solvents
- Includes Canister, Hose, Blow Gun, Rubber Tip and Cylinder Cap



Total A/C Quick Flush Kit

SKU 695646
MSC91051 **49⁹⁹**

- Includes: 17 Oz. Pressurized A/C Flush, Hose and Rubber Tipped Blow Gun with Thumb Control Pressurized to 150 PSI
- Non-Toxic Self Evaporating Single Use Disposable Cans



Can Taps

OEM TOOLS

Refrigerant and Oil Charge Can Tap

SKU 466313
24523 **19⁹⁹**

- Fits 1 Lbs. Cans of R134a, R12 and 2" Oil Charge Cans
- Plier Type Grip with Positive Lock
- Includes: 1/2" ACME Male and 1/4" FL Male Ports with Safety Valve



R134a DIY Refrigerant Recharge Kit

SKU 466316
24525 **19⁹⁹**

- Will Service Most R134a Systems
- Includes High Pressure Hose and Quick Disconnect Coupler



Digital Scales

OEM TOOLS

Digital Refrigerant Scale (240 Lbs. Capacity)

SKU 752521
24560 **149⁹⁹**

- High-Visibility .75" x 2.5" LCD Backlit Display
- (3) Units of Measure: kg/oz/Lbs.
- Automatic Shut-Off After 10 minutes, Backlight Will Shut-off After 3 Minutes
- Fully Enclosed and Removable Metal Scale Platform Enables Use of Product in or Out of the Protective Case



Accu-Charge II/ Electronic Charging Scale 240 Lbs. Capacity

SKU 290029
MSC98210A **229⁹⁹**

- Capacity: 240 Lbs.
- Programmable with Alarm



Leasing Terms Available!†

Ask Your AutoZone®
Commercial Sales Manager

AutoZone®
Tool & Equipment QUARTERLY

Manifold Gauges



R134a Brass Manifold Gauges Set
SKU 752520 24563 **64⁹⁹**
• High Quality Brass Body with Sight Glass
• Large 2-1/2" Gauges Are Easy to Calibrate and Have a High Impact Lexan Lens
• 60" 3,000 PSI Burst, 600 Working Pressure Hoses
• Snap Style Quick Couplers



R134a Manifold Gauge Set with Sight Glass
SKU 466319 24527 **99⁹⁹**
• Easy-to-Read Spring Dampened Gauges to Reduce Flutter
• 72" Hoses with Manual Couplers

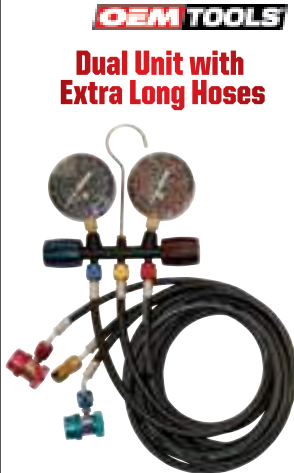

R134a/R12/R22 Dual Manifold Gauge Set
SKU 512961 27229 **149⁹⁹**
• For Use with R134a, R12 and R22
• 3,000 PSI Burst and 600 PSI Max
• SAE J2196/ R134a
• Extra Long High and Low Hoses: 72"; Freon Hose: 96"
• Manual Couplers Included



R1234YF Manifold Gauge Set
SKU 752518 24559 **149⁹⁹**
• 3" Easy-to-Read Gauges with Temperature Chart
• 72" Hoses
• High Quality 6 Ball Manual Couplers



R134a Aluminum Manifold Kit with Dye Injector
SKU 290023 MSC89660UV **149⁹⁹**
• Includes R134a Aluminum Manifold, 60" Hoses, Standard Couplers and 10 Application Mini Dye Injector



R134a Aluminum Manifold Kit with Dye Injector
SKU 290022 MSC89661UV **169⁹⁹**
• Includes R134a Aluminum Manifold, 60" Hoses, Manual Couplers and 10 Application Mini Dye Injector

Manifold Gauge Repair

1/4" Hose Set 72"
SKU 752515 24557 **39⁹⁹**
• 72" 1/4" SAE 3 Hose Set Color Coded: Red, Yellow and Blue
• Includes Spare Gasket and Depressor Set



R134a Hose Set 72"
SKU 752516 24558 **39⁹⁹**
• 72" R134a 3 Hose Set Color Coded: Red, Yellow and Blue
• Includes Spare Gasket and Depressor Set



1/4 In. Hose Set SAE 5 Ft.
SKU 347260 24390 **59⁹⁹**
• Maximum Working/ Burst Pressure 300PSI / 3000PSI
• Solid Brass Fittings 60" Long



Replacement Gauge Low Side for A/C Manifold
SKU 481709 24531 **14⁹⁹**
• This Is a Low Compound Gauge for OEMTOOLS and Other Brands of A/C Manifold Sets Used to Service A/C Systems On Cars
• Reads 0-120 PSI and 0-30" Hg
• 1/8" NPTF Male Threads



96 In. R134a Red Hose
SKU 489152 MSC84963 **39⁹⁹**
• 1/2" ACME-F 14 mm-M auto A/C fittings, 96"



96 In. R134a Blue Hose
SKU 489151 MSC84961 **39⁹⁹**
• 1/2" Acme-F and 14 mm-M Auto A/C Fittings - 96"



1/4 In. SAE Hose Set
SKU 512962 27230 **69⁹⁹**
• High Pressure Hose Length: 6 Ft. Low Pressure Hose Length: 6 Ft. Freon Hose Length: 8 Ft.



Replacement Gauge High Side for A/C Manifold
SKU 481705 24530 **14⁹⁹**
• This Replacement High Side Gauge Fits OEMTOOLS And Other Brands of A/C Manifolds Used to Service A/C Systems on Cars
• 1/8 In. NPTF Male Threads
• Reads 0-500 PSI



A/C Couplers

R134a Refrigerant Tank Adapter
SKU 850565 24554 **19⁹⁹**
• Male Low Side R134a to Female 1/2" ACME
• Attaches to Virgin Tank and Low Side Service Coupler Depressor



R134a High and Low Side Coupler Set
SKU 362980 24396 **39⁹⁹**
• Change Your Old R12 Manifold Set to R134a with this Set of Manual Couplers
• All Metal Construction for Extra Durability
• Includes Adapter for Use with R12 Hoses
• 6 Ball Coupler for Secure Grip



R134a Extra Long Coupler
SKU 752517 24556 **49⁹⁹**
• Used On BMW E60 (2003-2009 5 series) and Some Volvo Models
• Allows for A/C Service with No Radiator Removal



Conversion Coupler Set R134a to HFO-1234YF
SKU 752527 24561 **69⁹⁹**
• HFO-1234YF Manual Couplers with 14 mm Female Threads to Convert R134a Manifold and Hoses to HFO-1234YF
• Includes Tank Adapter, 1/2" ACME Right Hand to 1/2" ACME Left Hand Adapter



R134a High Side Manual Coupler
SKU 347267 24395 **29⁹⁹**
• All Metal Construction for Extra Durability 6 Ball Coupler for Secure Grip
• Includes an Adapter for Use with R12 Hoses



R134a Low Side Manual Coupler
SKU 347266 24394 **29⁹⁹**
• All Metal Construction for Extra Durability 6 Ball Coupler for Secure Grip
• Includes an Adapter for Use with R12 Hoses



A/C Service Tools

Compressor Turner Tool
SKU 504135 AIR67700 **24⁹⁹**
• OEM-Approved Compressor Start-up Assistance Prevent New Compressor Seizure at Startup Fits Most Hex-less Clutch Hubs



A/C Clutch Puller Jaws
SKU 695624 33627008 **23⁹⁹**
• The Clutch Puller Jaws from OEM Are Additional Jaws for Use with the OEM 27001 AC Pulley Puller



A/C Condenser Fin Comb Straightener/Cleaner
SKU 466317 24526 **12⁹⁹**
• Clean and Straighten Condenser and Evaporator Coils Compact Design for Confined Spaces Includes: (6) Clearly Marked Combs: 8, 9, 10, 12, 14 and 15 Fins per Inch



A/C Clutch Hub Remover
SKU 695628 33627005 **30⁹⁹**
• Removes Club Hutch from Ford ES-6 Compressors



A/C Clutch Hub Plate Remover
SKU 695626 33627006 **23⁹⁹**
• Removes Club Hutch from the Compressor
• For Use with Chrysler C-171, A590, 6C17 and Tecumseh HR-980 Compressor Clutches



A/C Clutch Hub Installer
SKU 695625 33627007 **17⁹⁹**
• For Use in Conjunction with OEM 27006, A/C Clutch Hub Plate Remover to Install Chrysler C-171, A590, 6C17 and Tecumseh HR-980 Compressor Clutches



A/C Clutch Plate Remover Shoe Tool
SKU 695630 33627002 **21⁹⁹**
• Used for GM A6 and R4 Compressor Clutches Simply Screw into Clutch and Turn Pressure Screw to Remove



A/C Compressor Pulley Removal Tool
SKU 695609 33627001 **45⁹⁹**
• Makes AC Compressor Pulley Removal Jobs Fast and Easy
• Can Be Used with OEM 27008 Clutch Puller Jaws



A/C Clutch Holding Tool
SKU 695102 33627000 **25⁹⁹**
• Holds Compressor Pulley in Place When Removing Holding Bolt
• Adjust Pins to Fit Holes in Clutch



Radiator/Condenser Cleaning Wand
SKU 514015 THX467A **99⁹⁹**
• New, Improved High Pressure Air/Water Cleaning Wand Reaches 24 Inches Between Radiator and Condenser, Under Mowing Decks, Etc. to Clean Away Dirt and Debris. Made of Zinc-Plated Steel with Adjustable Valve Assembly. Special Tips Deliver Air or Water at a 90 Degree Angle



Orifice Tube Remover Set
SKU 752530 24562 **39⁹⁹**
• To Use, Simply Turn into Orifice Tube for Grip Then Turn Out
• Includes Auger for Removing Broken Orifice Tubes



A/C Orifice Tube Tool
SKU 695629 33627004 **21⁹⁹**
• Fits Many GM and Ford Models



AIR CONDITIONING

SAVE \$20

USB Rechargeable UV Light with Glasses

SKU 626122
EXPE93-E02 **39⁹⁹** REG. \$59.99

GreatLite

- 1W Bulb that Casts a Beam Up to 5 Meters
- 0.8 Lumens
- 3 Light Modes: 100%, 50% and 25%
- Runtime: 12 Hours
- USB Cord
- Uses (2) CR123A or (1) 18650 Li-Ion Batteries
- UV400 High Impact Resistant Safety Glasses



Offer Good Through September 30, 2016 - While Supplies Last

Leak Detection Lights

OEM TOOLS



UV Pen Light

SKU 695128 **24⁹⁹**
24610

- Pen Style Ultra-Violet Light
- Lightweight, Aluminum Casing
- Convenient Pocket Clip
- Maximum Continuous Runtime is 4.5 Hours

Mastercool[®]
"World Class Quality"



Mini UV Flashlight - 12 LED

SKU 300782 **34⁹⁹**
MSC53512-UV

- 25,000 Hour Bulb Life 3 AAA Batteries / Operates for 22 Hours Under Normal Work Conditions Comparable to 50 Watt Illumination UV Goggles Included

Mastercool[®]
"World Class Quality"



Compact UV Flashlight - 17 LED

SKU 300783 **54⁹⁹**
MSC53517-UV

- 25,000 Hour Bulb Life 3 AAA Batteries / Operates for 22 Hours Under Normal Work Conditions Comparable to 75 Watt Illumination UV Goggles Included

Leak Detection

TP TRACER PRODUCTS
A Division of Spectronics Corporation

Complete A/C and Fluid Leak Detection Starter Kit

SKU 291378 **74⁹⁹**
TRATP8621

- 50 Watt 6 LED Lamp
- Pinpoints A/C, Oil Systems and Coolant Leaks
- EZ-Ject™ Dye Injector with (3) 1 Oz. Bottles of Dye



OPTI-PRO™/EZ-Shot™ A/C Dye Injection Kit

SKU 568718 **144⁹⁹**
TRATP8616

- Cordless, Economical, True UV Led Leak Detection Flashlight EZ-Shot A/C Dye Injection Gun 8 Oz (237 ml) BigEZ™ Universal/Ester A/C Dye Cartridge

TP TRACER PRODUCTS
A Division of Spectronics Corporation



EZ-Shot™ A/C and Fluid Leak Detection Kit with TP8620 OPTI-Lite™

SKU 291402 **159⁹⁹**
TRATP8626

- Kit Includes: Inspection Lamp, EZ-Shot™ A/C Dye Injection Gun, R134a Hose and Coupler with R-12 Adapter/Purge Fitting, 8 oz. BigEZ™ Universal Dye Cartridge for All A/C Systems, 8 oz. Spray Bottle of GLO-AWAY™ Dye Cleaner, Fluorescence-Enhancing Glasses, Underhood Labels and Plastic Carrying Case

TP TRACER PRODUCTS
A Division of Spectronics Corporation



Professional UV Leak Detection Kit with 12V/50W UV Light

SKU 290041 **84⁹⁹**
MSC53351

- 12 Volt/50 Watt UV Leak Detector. 1 Ounce Coolant Dye, 1 Ounce Oil/ATF/Fuel Dye, Dye Remover Mini Dye Injector (10 Applications of Universal A/C Dye) which is compatible with R134a and R12 Adapter UV Enhancing Safety Glasses 12 Service Labels



A/C Refrigerant Leak Detector

SKU 466307 **99⁹⁹**
24510

- Detects All Types of Halogenated Refrigerants
- Sensitive to 0.1 Oz./Yr.
- Single Color LED Display with 7 Level Leak Alarm
- Flexible Stainless Steel Probe to Reach to Almost Any Space
- Includes Spare Sensor Tip

TP TRACER PRODUCTS
A Division of Spectronics Corporation



IntellaSense II Refrigerant Leak Detector

SKU 695639 **299⁹⁹**
MSC55900

- Detects: Combustible Gases, Hydrogen, Refrigerants (all CFC's, HCFC's and HFC's)
- Includes Leak Test Vial and Replacement Filters in a Blow Molded Box Meets and Exceeds J2791 and J2913

Mastercool[®]
"World Class Quality"



Nitrogen Leak Test Kit

SKU 295560 **299⁹⁹**
MSC53010

- Tee Handle for Ease of Pressure Adjustment Kit
- Includes Leak Testing Gauges and Hoses



Electronic Leak Detector with 3 Sensitivity and 5 Detection Levels

SKU 290030 **199⁹⁹**
MSC55100

- Detects All Refrigerants (CFC's, HCFC's, HFC's) Meets and Exceeds SAE J1627

Mastercool[®]
"World Class Quality"



"Inspector" 2-in-1 Electronic/UV Leak Detector

SKU 290031 **199⁹⁹**
MSC55200

- Pin-point Leaks as Small as 1/10 Oz. (3 gr) per Year
- The Ultra Bright UV Light Is Built into the End of the Probe, Allowing Easy Access into Tight Areas

Mastercool[®]
"World Class Quality"



Identifier

Mastercool[®]
"World Class Quality"

Refrigerant Identifier for R134a

SKU 295556 **699⁹⁹**
MSC69134-A

- Avoid Potential Damage from Refrigerant Contamination
- Automatically Provides Step-by-Step Indication of the Gas Sampling Process
- Accuracy: Pass/Fail - 95% Pure R134a



Injectors

In-Line Dye and Oil Injector

SKU 466322 **39⁹⁹**
24532

- Add Up to 2 Oz. of Oil or Dye to a System Under Vacuum or While Adding Refrigerant
- 1/2" ACME Fittings to Fit Most R134a Systems
- Use with TRATP38400601 Bottle Fluoro-Lite® Universal A/C Dye

R12 and R134a Hand Turn Dye Injector

SKU 466320 **69⁹⁹**
24528

- Injects Dye or Oil into R12 or R134a Systems
- Refillable, Capacity: 2 Oz.
- Includes R134a Quick Coupler
- Use with TRATP38400601 Bottle Fluoro-Lite® Universal A/C Dye

TP TRACER PRODUCTS
A Division of Spectronics Corporation



EZ-Ject™ R-1234yf/PAG A/C Dye Injection Kit - Professional Grade!

SKU 568721 **79⁹⁹**
TRATP9844

- Multi-Dose Cartridge Prefilled With R-1234Yf/PAG A/C Fluorescent Dye
- Easily Overcomes System Pressure. Dye Can Be Injected While System Is Off Or Running
- EZ-Ject™ R-1234Yf/PAG A/C Dye Cartridge, Services Up to 14 Vehicles

TP TRACER PRODUCTS
A Division of Spectronics Corporation



EZ-Shot™ Universal A/C Dye Injection Kit - Universal and Economical!

SKU 568723 **134⁹⁹**
TRATP9790

- EZ-Shot™ Quickly Introduces Dye into a Vehicle's A/C System
- BigEZ™ Cartridges Are Prefilled with Co-Solvent Free A/C Dye, Certified to Meet SAE J2297 and Calibrated For Exact Dosing
- BigEZ™ 8 Oz Universal Dye Cartridge Services Up to 64 Vehicles

Leak Detection Fluid

TP TRACER PRODUCTS
A Division of Spectronics Corporation

1 Oz. Bottle Dye-Lite® All-In-One™ Oil Dye (6 Pack)

SKU 291395 **29⁹⁹**
TRATP3405

- Patented Formulation Works with ANY Leak Detection Lamp



TP TRACER PRODUCTS
A Division of Spectronics Corporation

1 Oz. Bottle Fluoro-Lite® Universal/POE A/C Dye (6 Pack)

SKU 291398 **51⁹⁹**
TRATP38400601

- Pourable Dye for Use with Many Dye Injectors Or Simply Pour into an Open System
- Includes 4 Applications for Standard Sized Systems



TP TRACER PRODUCTS
A Division of Spectronics Corporation

BigEZ™ 8 Oz. Universal Dye Cartridge

SKU 291396 **59⁹⁹**
TRATP97700108

- Treats Up to 64 Vehicles
- Fits Most Caulking Gun Injectors Including TRATP9790



Mastercool[®]
"World Class Quality"

Universal Concentrated Dye Cartridge - 1 Oz. (5 Pack)

SKU 505040 **94⁹⁹**
MSC53810-5

- 5 Pack of Dye for 53585 Leak Detector Kit
- 10 Applications per Bottle



Leasing Terms Available!†

Ask Your AutoZone®
Commercial Sales Manager

AutoZone®
Tool & Equipment QUARTERLY

A/C Hose and Line Repair

Line Splice Straight Repair Kit



- Effective, Durable Leak Repair with No Line Removal
- 5 Minute Install with a Wrench (No Special Tools, No Adhesives Required)
- High-Tech Anti-Vibration Tension Ring Ensures Durability in Tough Automotive Applications
- HNBR Seal Sleeve Dramatically Expands the Sealing Surface Area
- Burst Tested to 2600 PSI



SKU	Part #	Size	Price
SAE			
504140	AIR76003	5/16" Line	\$29.99
504138	AIR76002	3/8" Line	\$29.99
504136	AIR76001	1/2" Line	\$29.99
504143	AIR76011	5/8" Line	\$39.99
504145	AIR76012	3/4" Line	\$39.99
METRIC			
504132	AIR77008	8 mm Line	\$29.99
504155	AIR77010	10 mm Line	\$29.99
504156	AIR77012	12 mm Line	\$29.99
504133	AIR77015	15 mm Line	\$39.99
504117	AIR77016	16 mm Line	\$39.99

Smart Splice Straight Connectors

- When a Metal-to-rubber A/C Line Is Damaged, You Often Must Replace the Complete OE Line. If the Line Is Not in Stock Locally You Inconvenience Your Customer by Waiting for a Replacement Line. Quickly and Easily Connect A/C Reduced Barrier Hose to Metal Line Using AirSept's Smart Splice Line-to-Hose Connector™.
- Leak-Proof Line Splice™ Technology On the Metal Side of the Connection
- Superior Hose Crimp Technology On the Rubber Side
- Works for Heater and Coolant Lines Also
- Install in 5 Minutes



SKU	Part #	Size	Price
504125	AIR76701	1/2" Line to #8 Hose	\$29.99
504128	AIR76702	3/8" Line to #6 Hose	\$29.99
504129	AIR76703	5/16" Line to #6 Hose	\$29.99
504130	AIR76704	5/8" Line to #10 Hose	\$39.99
504131	AIR76705	3/4" Line to #12 Hose	\$39.99

Line Splice Straight Repair Kit Reducer

- Effective, Durable Leak Repair with No Line Removal
- 5 Minute Install with a Wrench (No Special Tools, No Adhesives Required)
- High-Tech Anti-Vibration Tension Ring Ensures Durability in Tough Automotive Applications
- HNBR Seal Sleeve Dramatically Expands the Sealing Surface Area
- Burst Tested to 2,600 PSI
- Also Works On Heater and Coolant lines



SKU	Part #	Size	Price
504141	AIR76004	3/8" to 5/16" Line	\$29.99
504095	AIR76005	1/2" to 5/16" Line	\$29.99
504142	AIR76006	1/2" to 3/8" Line	\$29.99

Line Terminator Rear A/C Blockoff Kits



- OE-approved Rear A/C Block-off Kits. Block Damaged or Unused A/C Lines — No Line R and R. Save Time and Satisfy Customers. Leaking Rear A/C Components or Lines Can Result in High Operating or Repair Costs. Many Car Owners Would Rather Avoid That Expense and Operate the Front A/C Unit Only. With Airsept's Line Terminator, You Can Give Your Customers an Affordable (Yet Still Profitable) Alternative to the High Cost of Repair or Replacement Labor.
- Quickly and Effectively Blocks A/C Lines at the Damage Point or at the Front System "Y"
- Block Off Leaking Rear Evaporators and Failed System Components
- Help Maximize Front A/C Performance
- Eliminate Refrigerant and Oil Pooling in Rear A/C Lines

SKU	Part #	Size	Price
504150	AIR76503	5/16" Line	\$22.99
504149	AIR76502	3/8" Line	\$22.99
504146	AIR76501	1/2" Line	\$22.99
504152	AIR76504	5/8" Line	\$26.99
504154	AIR76505	3/4" Line	\$31.99



Line Terminator SAE - 5 Pack

SKU 504122
AIR76526 **89⁹⁹**

- Quickly and Effectively Blocks A/C Lines at the Damage Point or at the Front System "Y" Block Off Leaking Rear Evaporators and Failed System Components
- Includes: One Each: 5/16", 3/8", 1/2", 5/8" and 3/4" SAE Kits



Line Terminator SAE/Metric - 10 Pack

SKU 504124
AIR76530 **179⁹⁹**

- Quickly and Effectively Blocks A/C Lines at the Damage Point or at the Front System "Y" Block Off Leaking Rear Evaporators and Failed System Components
- Includes: One Each: 5/16", 3/8", 1/2", 5/8" and 3/4" SAE Kits, Plus One Each: 8 mm, 10 mm, 12 mm, 15 mm and 16 mm Metric Kits



Line Splice Straight SAE (5 Pack)

SKU 504101
AIR76050 **139⁹⁹**

- Effective, Durable Leak Repair with No Line Removal
- OE Approved
- 5 Minute Install - No Special Tools
- Includes One Each: 5/16", 3/8", 1/2", 5/8" and 3/4" Line Splice Kits



Line Splice Straight SAE/Metric - 10 Pack

SKU 504103
AIR76051 **269⁹⁹**

- Effective, Durable Leak Repair with No Line Removal
- OE Approved
- 5 Minute Install - No Special Tools
- Includes one each: 5/16", 3/8", 1/2", 5/8" and 3/4" SAE Line Splice Kits, Plus One Each: 8 mm, 10 mm, 12 mm, 15 mm and 16 mm Metric Line Splice Kits



R134a / R12 Charging Hose Repair Kit

SKU 295557
MSC91334-A **44⁹⁹**

- 55 Piece Assortment of Replacement Gaskets, O-rings, Depressors for Charging Hoses and Adapters



Airsept Smart Splice Ultimate Line Repair Kit

SKU 687976
AIR76057 **1,769⁹⁹**

- Everything Needed to Repair A/C, Power Steering Return, Transmission, Trans Oil Cooler, Engine Oil, Engine Oil Cooler, Coolant and Heater Lines
- OEM Approved Line Repair Solution Installs in Five Minutes, On the Vehicle, without Special Tools or Adhesives
- Leak Free Up to 2600 PSI



All-In-One A/C Line Repair Solution!



Airsept Smart Splice Multi System Line Repair Tray

SKU 687973
AIR76076 **524⁹⁹**

- Includes: 1 Each 5/16", 3/8", 1/2", 5/8", 3/4" Line Splice Straight SAE Repair Kits; 1 Each 8 mm, 10 mm, 12 mm, 15 mm, 16 mm Line Splice Straight Metric Repair Kits; 1 Each 5/16", 3/8", 1/2", 5/8" Line Splice 45° SAE Repair Kits; 1 Each 5/16", 3/8", 1/2", 5/8" Line Splice 90° SAE Repair Kits
- Top Tray in Master Cabinet



Airsept Smart Splice Line Terminator and Service Tee Repair Tray

SKU 687974
AIR76077 **499⁹⁹**

- Everything Needed to Block Off A/C, Coolant and Heater Lines, or Add a A/C Service Port
- SAE Sizes for 5/16", 3/8", 1/2", 5/8", 3/4" OD Metal Lines
- Metric Sizes for 8 mm, 10 mm, 12 mm, 15 mm, 16 mm OD Metal Lines



Airsept Smart Splice Hose To Tube, Hose To Hose Repair Tray

SKU 687975
AIR76078 **549⁹⁹**

- Everything Needed to Make Hose to Line or Hose to Hose Repairs on A/C, Coolant and Heater Lines
- Includes: SAE Sizes for 5/16", 3/8", 1/2", 5/8", 3/4" OD Metal Lines, SAE Sizes for #6, #8, #10, #12 3/4" A/C Reduced Barrier Hose



Airsept Smart Splice Aluminum Tube Insert Service Tray

SKU 687989
AIR76079 **219⁹⁹**

- Repair Long Sections of Damaged or Leaking A/C, Power Steering Return, Transmission, Trans Oil Cooler, Engine Oil, Engine Oil Cooler, Coolant and Heater Lines.
- Includes 12' Lengths of Aluminum Tubing for SAE and Metric Lines



Airsept 5 Piece Smart Splice Tool Assortment

SKU 688003
AIR76080 **159⁹⁹**

- Includes: De Burring Tool, Tube Cutter, Caliper, Pex Crimper, Rubber Hose Crimper



Manual Style A/C Hose Crimper, Bench or Vise Mounted

SKU 290028
MSC71550 **249⁹⁹**

- The 71550 is our "Manual Style" A/C Hose Crimper. The Dies Snap Quickly into Place Requiring No Pins or Screws. The Unit Can Be Easily Mounted to a Bench Using the Holding Fixture or Held Securely in a Vice. This Kit Comes with a Complete Set of Dies Covering Standard Hose Sizes #6, #8, #10 and #12.
- Includes: 71500 - 001 Yoke Assembly 71550 - 002 Arbor Assembly 71550 - 003 Holding Fixture Assembly 71500 - 6 Die Set - #6 (5/16 In.) 71500 - 8 Die Set - #8 (13/32 In.) 71500 - 10 Die Set - #10 (1/2 In.) 71500 - 12 Die Set - #12 (5/8 In.) 71500-PB Custom Mold Box Carrying Case



Hydra-Krimp A/C Hose Crimping Tool

SKU 290027
MSC71500 **749⁹⁹**

- Repair A/C Hoses On or Off the Vehicle
- Includes a Complete Set of Dies Covering Hose Sizes #6, #8, #10, #12 and Reduced Barrier #6, #8, #10 and #12



Heavy Duty Ratcheting Hose Cutter

SKU 466311
24522 **16⁹⁹**

- Smooth Action and High Quality Blade Provide Quick, Clean and Accurate Cuts
- Cuts Rubber Hose and PVC up to 1-1/2" OD



AIR CONDITIONING

RECOVERY/RECYCLE/RECHARGE MACHINES

ROBINAIR



SKU221185
ROB34288
\$2899.99



SKU249512
ROB34988
\$4199.99



SKU751569
ROB34788NI
\$3799.99



SKU751572
ROB34788NI-H
\$3899.99



SKU751575
ROBAC1234-6
\$6399.99

Features	34288	34988	34788NI	34788NI-H	AC1234-6
Fully-Automatic Function: Program to recover, vacuum, leak test and charge without operating panel valves.		X	X	X	1234YF A/C Service
Automatic Dye Inject: Gives the user the ability to use the machine to inject UV dye into a vehicle's A/C system.		X			<ul style="list-style-type: none"> Fully automatic operation — program for service, walk away and return when complete. 95% recovery efficiency Programmable vacuum operation helps get to the necessary vacuum level in any condition quickly. System leak test to identify gross leaks in a system. Charge accuracy within +/- 1/2 oz. Automatic oil drain shows how much oil was removed from the system during service. Automatic air purge removes the potential of air accumulating in the internal tank. Integrated refrigerant identifier(meets SAE J2927) Liquid refrigerant flushing function can flush A/C systems or individual components using liquid refrigerant instead of harsh chemicals. Automatic internal tank refill. No stopping to fill the internal tank during service, or before service. 1/4 Color VGA display. Large easy to read graphical display On-board printer capable of printing vehicle service report slips to present to customers.
Automatic Oil Drain: A display reminds you to empty the graduated container to show the amount of oil to replace.	X	X	X	X	
Oil Inject: Automatically inject oil back into the vehicle's A/C systems.		X	X		
Refrigerant and Oil Database: A/C system capacities for North American market vehicles (Optional – not included with the machine)		Optional	Optional	Optional	
A/C System Flush: Flushes a vehicle's A/C system with refrigerant, eliminating any residual oil or other liquid. (Flushing adapters not included)		X	X	X	
Save and Print Before and After Service Data: Allows the user to store before and after service information by vehicle and print this information to provide to a customer.		X	X	X	
Visual and Audible Alarm: Notifies the user when service is complete, or if a problem has occurred.		X	X	X	
Vacuum Leak Test: Monitors level after evacuation, informs of possible leak.	X	X	X	X	
Automatic Air Purge: Eliminates system-damaging air without monitoring gauges or opening valves.	X	X	X	X	
Automatic Refrigerant Refill: Maintains a user-selectable amount of refrigerant in an internal vessel and signals when it's time to change supply tank, no monitoring required.					
Vacuum Feature: Defaults to 15 mins, programmable up to 99 mins. "Remaining time" is displayed.		X	X	X	
Display: Multilingual.	X	X	X	X	
Refrigerant Charging: Select a charge mode from high or low side, or use both sides.		X	X	X	
Refrigerant Management System: Displays refrigerant use and monitors remaining filter life. Prompts appear when 1/3 of filter life remains.	X	X	X	X	
Electric Vehicle: Capable of servicing high voltage electric compressor A/C systems.					X
Printer		X	Optional	Optional	
Refrigerant Identifier			Optional	Optional	

Diagnostic

Fastest code-to-fix[®] with a lifetime warranty

New Bravo 2.0 software is faster and more responsive

The OTC Encore features enhanced diagnostic coverage and a lifetime hardware warranty. * Warranty never expires if subscription is kept current. The mobile, Android-based system is easy to use, intuitive and fast.

No tool helps you fix faster than OTC Encore

- Re-engineered Bravo 2.0 software is faster, more responsive.
- First OTC tool with Bosch coverage database for European vehicles, including Mercedes-Benz, BMW and Volvo
- AutoID most CAN vehicles in less than 5 seconds
- Read and clear codes in seconds
- Access top reported code fixes in seconds
- Extended-hours tech service days, nights and Saturdays. Call 888-789-2602.

30 Years of Unmatched OE Coverage

Encore alerts technicians to on-tool or web-based repair information including Identifix Direct-Hit™. Full scan functionality, including OEM Domestic, Asian and European, bi-directional controls and enhanced data perform a Google search right within a diagnostic session.

SKU 463113

3893

Encore, OBD II cable, USB cable, power adapter and hard carrying case.

MAP price **\$1899.00**



Check out the Encore TPMS sensor registration process here.



OTC

3210 CodeConnect with ABS and Airbag

New and improved software with 4 multifunction buttons for added functionality.

- Expanded European ABS DTC coverage
- 26 Million+ CodeConnect Top Reported Fixes
- Oil light and battery resets
- Stores five vehicle's scan data
- View vehicle fuel mileage using MAF data
- USB update cable and batteries included



3210
MAP price
\$375.99

OTC



13,000 confirmed HD diagnostic fixes

New ESI[repair] subscription service with 13,000 trouble code fixes.

Free trial for current tool owners. Confirmed fixes based on module, code and truck configuration.

Visit boschdiagnostics.com/pro to learn more.

3824-08R

ESI [Truck] HD Diagnostics

UNMATCHED COVERAGE AND REPAIR INFORMATION AT THE TRUCK

The most complete diagnostic coverage for multibrand heavy-duty trucks and engines, performing special tests and parameter reset capabilities.

NEW REPAIR INFORMATION SUBSCRIPTION SERVICE

ESI[repair] subscription service for ESI[truck] includes 13,000 experienced based fixes. ALSO The tool includes fixes specific to trouble codes and symptoms with repair information that can be viewed while still in diagnostic mode.

TRUCK COVERAGE

Trucks: Freightliner, International, Kenworth, Mack, Volvo, Peterbilt, Sterling, Westernstar, MD Trucks (Freightliner Sprinter Van, Isuzu, GM and Ford). Trailer ABS Controllers; Allison and Eaton Transmissions

ENGINE COVERAGE

Heavy duty engines – Caterpillar, Cummins, Detroit Diesel-MBE, Deutz, Mack, MTU, Navistar, PACCAR, Perkins and Volvo. Medium and light duty engine software included.

SKU 851263

3824

WINDOWS 7 TABLET SCAN TOOL

Includes VCI, 6 pin and 9 pin cables

MAP price **\$9995.99**

3824BSC

SCAN KIT

Use with your shop PC

Includes Bosch diagnostic software, VCI, 6 and 9 pin cables.

MAP Price **\$7450.00**



BOSCH

Invented for life

Leasing Terms Available!†

Ask Your AutoZone®
Commercial Sales Manager

AutoZone®
Tool & Equipment QUARTERLY

Engine Service



OTC

SKU 432093
6918 **79⁹⁹**

Ford Spark Plug Remover Kit, Triton 3V

- Unique design helps prevent breakage by locking the plug porcelain core to the plug hex allowing it to turn as one complete unit.
- Will also pull plug porcelain core if plug hex only is removed.
- Detailed Instructions to maximize success rate.

Works on:

- Ford 4.6L 3V V8 engines used in 2005–2008 Mustang, 2006–2008 Explorer.
- Ford 5.4L 3V V8 engines used in 2004–2008 F-Series, 2005–2008 Expedition, 2005–2008 Lincoln Navigator.
- Ford 6.8L 3V V10 engines used in 2005–2008 F-Series 250-350-450.



SKU 112478
7424 **14⁹⁹**

Belt Holding Tool

- Keeps belt from falling off of a pulley during belt installation.
- Universal design to fit most pulley styles and sizes.
- Super strong magnet to hold the belt firmly on the pulley.
- Multiple holders can be used for belt applications that fit around many pulleys.
- Durable plastic housing with magnet for steel/iron pulley applications.



Puller Service

5 lb. Hammer in
Polished Chrome
Finish.



SKU 110811
4579 **99⁹⁹**

9-Way Slide Hammer Puller Set

- Pulls flange-type rear axles and most front-wheel drive hubs.
- Internal and external jaws provide a variety of combinations to pull bearings, gears and seals.
- Two- and three-way cross blocks and cone provide the perfect jaw configuration for most jobs.
- Set also includes a grip wrench adapter and a dent puller attachment for sheet metal or other unique pulling requirements.
- Designed for use with other OTC 5/8"-18 thread slide hammer attachments.
- Packaged in blow-molded case.



SKU 491272
1183 **399⁹⁹**

Bearing Splitter Combo Set

This combo pack contains four of OTC's most popular bearing splitters, plus a pulley pulling attachment. A rugged organizer case is included, enabling you to keep the tools together for instant use.



OTC

SKU 291457
6575 **549⁹⁹**

OTC Hub Grappler™

- The Hub Grappler Kit is the complete solution for servicing wheel hubs and bearings on the vehicle without removing the steering components or knuckle. This eliminates unnecessary alignments or the use of a shop press, cutting service time dramatically.
- The new Hub Grappler Puller is specifically designed to apply maximum force with minimal effort from an impact gun to also minimize service time.
 - The new jaws are designed and sized to properly fit hub applications and can be quickly located on the puller bar without the use of fasteners.



- The new 3/4" custom drive screw coupled with the special equalizer washer provides smooth operation while the proprietary heat treating extends its life 5-10 times longer than similar designs.
- 6 new adapters increases application coverage up to 2009 model year. Also includes tie rod/ball joint tool and 2 Ford axle installers.
- The Hub Grappler Application Guide is the most comprehensive hub and bearing service guide on the market. Developed to be the first tool used in the kit, it provides quick reference to the other tools in the kit required to do the job, eliminating guesswork and saving time.



SKU 112535
6530 **349⁹⁹**

Ball Joint Intermediate Service Kit

- This 20+ adapter kit covers many Truck/Van/SUV applications and some car applications.
- With the majority of Cars and Truck/Van/SUV applications having press-in ball joints and universal joints, this kit is designed to service many of those applications.
- This kit is a combination of 7249, 7918, and 7996 kits, and includes 20+ adapters, C-Frame, and Application Diagrams all provided in a case.



Fasteners



OTC

SKU 112536
5900A **109⁹⁹**

Master TORX® Socket Set

- 52-piece, professional socket set in a blow-molded case. Hundreds of applications from front to rear on cars and trucks:
- Seat belt bolts
 - Engine assemblies
 - Bumpers
 - Door strikers & latches
 - GM front-wheel drive front wheel bearings
 - Truck box liners
 - Interior and exterior trim screws
 - Tail lamp lenses & assemblies
 - Headlight bezels
 - Brake rotor bolts
- Styles available: TORX, TORX PLUS, tamper-resistant TORX and external TORX.
- Made from superior S2 steel to meet or exceed torque specifications.



SKU 291472
6980 **99⁹⁹**

OTC Brake Drum & Rotor Puller

- Handles large components such as brake drums, rotors, drive gears, flywheels, and pulleys.
- One person can easily set the tool in place and use for tough pulls even where there is little access to insert the jaws.
- Spread to 12-3/4" and 5" of reach.
- 7-tons of force, yet weighs less than 10 pounds.
- Can be used with air tools to reduce time and fatigue.



SKU 087314
OTC5950A **29⁹⁹**

CrimPro™ 4-in-1 Angled Wire Tool

- Compact 7-inch design.
- Gripping nose.
- Crimper, 12-20 AWG insulated & non-insulated wire.
- Stripper – strips 12-20 AWG wire.
- Cutter – ability to make cuts both above and below pivot.



SKU 087317
OTC5950S **25⁹⁹**

CrimPro™ 4-in-1 Wire Tool

- Compact 7-inch design.
- Gripping nose.
- Crimper, 12-20 AWG insulated & non-insulated wire.
- Stripper – strips 12-20 AWG wire.
- Cutter – ability to make cuts



TIRE SERVICE



Contact Us:
1-877-AZTool1 Phone
 (1-877-298-6651) *Hablamos Español*

Complete Tire and Wheel Service



Dannmar® T-100 Tire Changer and B-100 Wheel Balancer Combo

SKU 818788 **2,799⁹⁹**
 DAN1381801
 REG. \$3,049.98

- Includes: DAN1381201 Dannmar T-100 Tire Changer and DAN1381202 Dannmar B-100 Wheel Balancer
- This Dannmar Combo is Best Suited for Gas Stations, Small Garages and Auto Salvage Yards. With the T-100, B-100 Combo You Get Great Value and More Bang for Your Buck
- T-100 - Outside Clamp: 12" - 22"
- B-100 - Rim Diameter: 1" - 28"
- B-100 Includes Data Acquisition Wand and Quick Nut
- 1 Year Parts Only Warranty

Lift Gate Service
 SKU 262534
 DANLIFTGATE **100⁰⁰**



DAN1381201

Price Does Not Include Tires or Rims as Shown.



DAN1381202

1,599.99 Tire Changer
+1,449.99 Wheel Balancer
\$3,049.98 TOTAL
\$2,799.99 COMBO DEAL
\$249.99 SAVE

Ranger Tire Service Package

SKU 851131
 RANCOMBO1 **3,699⁹⁹**
 REG. \$3,779.98

- Includes: R980XR NEXTGEN™ Swing-Arm 25" Tire Changer and the DST-2420 Dynamic Wheel Balancer
- R980XR External Rim Clamping Capacity: 9" - 28"
- The Highly Accurate DST-2420 Dynamic Wheel Balancer Dependably Ensures an Accurate Result Within Hundredths of an Ounce

Lift Gate Service
 SKU 262533
 RANLIFTGATE **135⁰⁰**

Dual Position RimGuard™ Wheel Clamps

INCLUDES
 Includes Wheel Weight Starter Kit

Wheel Weight Starter Kit Includes One Bulk Roll of 100 Silver Adhesive Steel Tape Weights, One Bulk Roll of 100 Black Adhesive Steel Tape Weights and One Starter Box of Mixed Clip-On Steel Tape Weights



Price Does Not Include Tires or Rims as Shown.

RANDST2420



RANR980XR

2,099.99 Tire Changer
+1,679.99 Wheel Balancer
\$3,779.98 TOTAL
\$3,699.99 COMBO DEAL
\$79.99 SAVE

SAVE ON COMBO OFFERS!

Combo with geodyna® 7100 Balancer and monty1520 Tire Changer

SKU 079535 **5,899⁹⁹**
 HOFCOMBO4
 REG. \$7,549.98

- Includes: Hofmann geodyna 7100 Car Wheel Balancer with LED Display and HOFM1520110 monty1520 20" Capacity Tire Changer

4,149.99 Tire Changer
+3,399.99 Wheel Balancer
\$7,549.98 TOTAL
\$5,899.99 COMBO DEAL
\$1,649.99 SAVE



HOFM1520110

Price Does Not Include Tires or Rims as Shown.



INCLUDES
 On-Site Factory Authorized Training

Lift Gate Service
 SKU 290017
 HOFLIFTGATE **95⁰⁰**

Combo with geodyna® 7200s Balancer and monty1575 Tire Changer plus Bead Assist

SKU 080105 **8,399⁹⁹**
 HOFCOMBO3
 REG. \$8,999.97

- Includes: HOFEEWB746A geodyna® 7200s High Performance Wheel Balancing System and HOFMONTY1575B Tire Changer
- Also Includes Patented Easymont Pro, Aiding In Single-Operator Mounting/Demounting Of Extra-Stiff, Low-Profile, High Performance and Run-Flat Tires



Made in USA



HOFMONTY1575B

Performance and Value

NEW

Price Does Not Include Tires or Rims as Shown.

INCLUDES
 On-Site Factory Authorized Training

Lift Gate Service
 SKU 290017
 HOFLIFTGATE **95⁰⁰**

Coats® RC-55E and 1150-2D Tire Service Combo

SKU 818790 **9,599⁹⁹**
 AMMCOMBO1
 REG. \$10,199.98

- The Ideal Combo Packed with Features for Front Line Tire Service
- This package includes: Coats AMM85001 150 Wheel Balancer with direct drive, direct Tape-A-Weight® Measurement and Static-On-Screen combined with AMM8560995001 RC-55E Tire Changer featuring the RC Robo-Arm®, built-in bead sealing jets and conveniently placed foot pedals.

5,599.99 Tire Changer
+4,599.99 Wheel Balancer
\$10,199.98 TOTAL
\$9,599.99 COMBO DEAL
\$599.99 SAVE



AMM85001150

AMM8560995001

Price Does Not Include Tires or Rims as Shown.

INCLUDES
 Manufacturer's Set-Up and Training

Lift Gate Service
 SKU 262529
 AMMLIFTGATE **55⁰⁰**

Tire Changers

monty® 1520 20" Capacity Tire Changer

- SKU 290001 **4,149⁹⁹**
 HOFM1520110
- Outer Wheel Clamping Diameter: 10" - 18"
 - Bead Breaker Range: 2" - 13"
 - Bead Loosening Power: 6,000 Lbs.
 - Maximum Wheel Width: 13"
 - Maximum Outer Tire Diameter: 40"

Price Does Not Include Tires or Rims as Shown.



INCLUDES
 On-Site Factory Authorized Training

Lift Gate Service
 SKU 290017
 HOFLIFTGATE **95⁰⁰**

Warranty on all Hofmann Tire Changers
 5 year transmission
 3 year motor 1 year standard parts
 6 months labor



Made in USA

monty® 1575 Tire Changer

- SKU 849298 **3,499⁹⁹**
 HOFMONTY1575B
- Ideal for Shops Looking for Great Value Without Sacrificing Productivity
 - Outer-Wheel Diameter of 21"
 - Accommodates Tire Diameter of 40"
 - Powerful Inflation System

Price Does Not Include Tires or Rims as Shown.



INCLUDES
 On-Site Factory Authorized Training

Lift Gate Service
 SKU 290017
 HOFLIFTGATE **95⁰⁰**

Warranty on all Hofmann Tire Changers
 5 year transmission
 3 year motor 1 year standard parts
 6 months labor



Made in USA

monty® 1625 Tire Changer

- SKU 849300 **4,499⁹⁹**
 HOFMONTY1625B
- Designed for High-Volume Tire Shops, Multi-Bay Repair Shops and Car Dealerships
 - Outer-Wheel Diameter of 24"
 - Accommodates Tire Diameter of 42"
 - Powerful Inflation System

Price Does Not Include Tires or Rims as Shown.



INCLUDES
 On-Site Factory Authorized Training

Lift Gate Service
 SKU 290017
 HOFLIFTGATE **95⁰⁰**

Warranty on all Hofmann Tire Changers
 5 year transmission
 3 year motor 1 year standard parts
 6 months labor



Made in USA

monty® 1625EM 24" Capacity High Performance Tire Changer "with Bead Assist"

- SKU 467483 **8,499⁹⁹**
 HOFM1625EM110
- Outer-Wheel Clamping Diameter: 10" - 24"
 - Bead Breaker Range: 2" - 18"
 - Bead Loosening Power: 6,000 Lbs.
 - Maximum Wheel Width: 15"
 - Maximum Outer Tire Diameter: 42"

Price Does Not Include Tires or Rims as Shown.



INCLUDES
 On-Site Factory Authorized Training

Lift Gate Service
 SKU 290017
 HOFLIFTGATE **95⁰⁰**

Warranty on all Hofmann Tire Changers
 5 year transmission
 3 year motor 1 year standard parts
 6 months labor



Made in USA

Leasing Terms Available!+

Ask Your AutoZone®
Commercial Sales Manager

AutoZone
Tool & Equipment QUARTERLY

Tire Changers

Tilt Back Tire Changer / 30" Capacity NextGen™ Series

SKU 544546 **2,149⁹⁹**
RANR76LT

- Drive System Type: Electric/Air
- Motor: 2 HP (110 - 220VAC 50 - 60 Hz)
- Air Requirement: 110 - 175 PSI/8 - 12 Bar
- External Rim Clamping Capacity: 9" - 28"
- Internal Rim Clamping Capacity: 10" - 30"
- Table Clamping System: Dual Pneumatic Cylinders
- Bead Breaking System: Pneumatic Blade
- Tower Design Tilt-Back

Lift Gate Service
SKU 262533
RANLIFTGATE **135⁰⁰**

Price Does Not Include Tires or Rims as Shown.



TOP SELLER

Swing Arm Tire Changer / 30" Capacity NextGen™ Series

SKU 312817 **2,099⁹⁹**
RANR980XR

- Drive System Type: Electric/Air
- Motor: 2 HP (110/208 - 240VAC 50 - 60 Hz)
- Air Requirement: 140 - 165 PSI/ 10 - 11 Bar
- Bead Breaker Tire Width Capacity Demount: 1.5" - 16" (38 mm - 406 mm)
- Internal Rim Clamping Capacity: 10" - 30" (254 mm - 762 mm)
- External Rim Clamping Capacity: 9" - 28" (229 mm - 711 mm)
- Bead Seating System: Turbo Blast/Bead Seating

Price Does Not Include Tires or Rims as Shown.

Lift Gate Service
SKU 262533
RANLIFTGATE **135⁰⁰**



Swing Arm Tire Changer 30" Capacity NextGen™ Series

SKU 544590 **2,399⁹⁹**
RANR980XRF

- Internal Rim Clamping Capacity: 10" - 30"
- Maximum Tire Diameter: 50"
- 2 HP, (208 - 240V, 50 - 60 Hz, 1 Phase Only)

Lift Gate Service
SKU 262533
RANLIFTGATE **135⁰⁰**

Price Does Not Include Tires or Rims as Shown.

Features True Variable Speed Control



Swing Arm Tire Changer / Single Tower Assist / 30" Capacity NextGen™ Series

SKU 544537 **2,999⁹⁹**
RANR980AT

- External Rim Clamping Capacity: 9" - 28"
- Internal Rim Clamping Capacity: 10" - 30"
- Maximum Tire Diameter: 50"
- Motor: 2 HP (110/208 - 240V, 50 - 60 Hz)

Lift Gate Service
SKU 262533
RANLIFTGATE **135⁰⁰**

Price Does Not Include Tires or Rims as Shown.



RimGuard™ 28" Swing-Arm and Single Power Assist Tire Changer

SKU 544542 **3,299⁹⁹**
RANR980ATF

- 2 HP (208 - 240V, 50 - 60 Hz, 1 Phase Only)
- External Rim Clamping Capacity: 9" - 28"
- Internal Rim Clamping Capacity: 10" - 30"
- Maximum Tire Diameter: 50"

Features True Variable Speed Control

Swing Arm Tire Changer / Single Tower Assist / Variable Speed / 30" Capacity NextGen™ Series

SKU 544547 **3,599⁹⁹**
RANR980NXTF

- 2 HP (208 - 240V, 50 - 60 Hz, 1 Phase Only)
- External Clamping (Outer): 9" - 28"
- Maximum Tire Diameter: 50"

Features True Variable Speed Control

Lift Gate Service
SKU 262533
RANLIFTGATE **135⁰⁰**

Price Does Not Include Tires or Rims as Shown.



Tilt Back Tire Changer / Right Tower Single Assist / 30" Capacity NextGen™ Series

SKU 544543 **3,499⁹⁹**
RANR76ATR

- Alloy Steel Mount and Demount Head, Nylon Tool Head also Comes Standard
- External Rim Clamping Capacity: 9" - 28"
- Forged Steel Foot Pedal Levers
- Maximum Tire Diameter: 43"

Tilt-Back 28" with Assist Tower Tire Changer

SKU 544550 **3,899⁹⁹**
RANR76ATRF

- External Rim Clamping Capacity: 9" - 28"
- Maximum Tire Diameter: 43"
- 2 HP (208 - 240V, 50 - 60 Hz, 1 Phase Only)

Features True Variable Speed Control

Lift Gate Service
SKU 262533
RANLIFTGATE **135⁰⁰**

Price Does Not Include Tires or Rims as Shown.



Swing Arm Tire Changer / Single Tower Assist / 32" Capacity NextGen™ Series

SKU 312819 **3,699⁹⁹**
RANR30XLT

- Internal Rim Clamping Capacity: 13" - 33"
- External Rim Clamping Capacity: 10" - 28"
- Turntable Tire Width Capacity Mount: 5" - 22"
- Bead Breaker Tire Width Capacity Demount: 3" - 15"
- Maximum Tire Diameter: 50"

Lift Gate Service
SKU 262533
RANLIFTGATE **135⁰⁰**

Price Does Not Include Tires or Rims as Shown.



Tire Changers

ENTRY LEVEL TIRE CHANGERS

User Setup Required. Factory Authorized Service Network Available.

Comes with 1 Year Motor and Trans Parts Only Warranty

BL300 Tire Changer with 24" External Clamping Capacity

SKU 510997 **2,099⁹⁹**
AMM85002300

- Drive System: Electric
- Rim Width: 10" Maximum
- Includes Bead Sealing Jets to Aid in Inflation
- Wheel Clamping Capacity: 10" - 24" External 12" - 26" Internal

Price Does Not Include Tires or Rims as Shown.

BASELINE

BUY **300/350 COMBO** GET **\$200** FACTORY REBATE
Purchase the Tire Changer/Balancer Combo and Receive a \$200 Rebate!

\$200 Factory Cash Back Rebate! For Details Go to www.rebate.ammcoats.com

Lift Gate Service SKU 262529 AMMLIFTGATE **55⁰⁰**



BL500 Tire Changer with 24" External Clamping and Robo-Arm®

SKU 509828 **2,799⁹⁹**
AMM85002500

- Drive System: Electric
- Rim Width: 10" Maximum
- Includes Bead Sealing Jets to Aid in Inflation
- Wheel Clamping Capacity: 10" - 24" External, 12" - 26" Internal
- Fully Articulating Robo-Arm Helper to Aid in Mounting Stiffer Sidewall Tires

Price Does Not Include Tires or Rims as Shown.

BASELINE

BUY **500/550 COMBO** GET **\$400** FACTORY REBATE
Purchase the Tire Changer/Balancer Combo and Receive a \$400 Rebate!

\$400 Factory Cash Back Rebate! For Details Go to www.rebate.ammcoats.com

Lift Gate Service SKU 262529 AMMLIFTGATE **55⁰⁰**



TIRE SERVICE

Leasing Terms Available!*

Ask Your AutoZone®
Commercial Sales Manager

Tire Changers

RC-45E Rim Clamp® Tire Changer

SKU 688225 (Electric)
AMM8560994901

3,999⁹⁹

- External Rim Clamping Range: 10" - 21"
- Maximum Rim Width: 10.5"
- Maximum Tire Diameter: 50"
- Includes Bead Sealing Jet to Aid Inflation

Price Does Not
Include Tires or
Rims as Shown.

\$350
Factory Cash Back Rebate!
For Details Go to
www.rebate.ammcoats.com

INCLUDES
Manufacturer's
Set-Up and Training

Lift Gate Service
SKU 262529
AMMLIFTGATE **55⁰⁰**



RC-55E Rim Clamp® Tire Changer

SKU 688223
AMM8560995001

5,599⁹⁹

- Robo-Arm® Power Assist for Low-Profile and Run-Flat Tires
- External Rim Clamping Range from 10" - 21" Diameter
- Maximum Rim Width 10.5"
- Maximum Tire Diameter 50"
- Electric Turntable

Price Does Not
Include Tires or
Rims as Shown.

INCLUDES
Manufacturer's
Set-Up and Training

Lift Gate Service
SKU 262529
AMMLIFTGATE **55⁰⁰**



70X Rim Clamp® Tire Changer

SKU 979918
AMM80070XEHI

8,049⁹⁹

- Increase Clamping Capacity: 6" - 24"
- Max Rim Width: 14"
- Max Tire Diameter: 50"
- Includes Basic Kit

NEW

Grip Max® Plus Adjustable Clamps

SKU 012699
AMM85607986

649⁹⁹

- 16"-28" External Clamping
- Updated Jaw Profile Accommodates Newer Rim Flange Profiles
- Wider Grip Contact Area and New Material Further Reduce Slip on Polished Surfaces

INCLUDES
Manufacturer's
Set-Up and Training

Lift Gate Service
SKU 262529
AMMLIFTGATE **55⁰⁰**

Price Does Not
Include Tires or
Rims as Shown.

\$400
Factory Cash Back Rebate!
For Details Go to
www.rebate.ammcoats.com



GTS-70 Tilt-back Tire Changer

SKU 019305
AMM85610076

8,499⁹⁹

NEW

- Powered Roller Disk: Multiple Uses Include: Bead Loosening, TPMS Access, Bottom Bead Removal and Top Bead Mounting
- Rim Diameter 6-24" External
- Rim Width 15"
- Electric Drive System 1HP Electric Motor, 110VAC

Price Does Not
Include Tires or
Rims as Shown.

INCLUDES
Manufacturer's
Set-Up and Training

Lift Gate Service
SKU 262529
AMMLIFTGATE **55⁰⁰**

\$500
Factory Cash Back Rebate!
For Details Go to
www.rebate.ammcoats.com



90X Rim Clamp® Tire Changer with Robo-Arm®

SKU OUTSIDE BUY/EPO
AMM80090XEHL

11,499⁹⁹

NEW

- Hybrid Leverless Duckhead® - Eliminates Traditional Tire Tools That Can Mar The Surface By Eliminating The Metal-To-Metal Contact
- RoboRoller® - Provides Additional Power When Mounting Difficult Tire Assemblies
- Rim Diameter: 6-24" External
- Rim Width: 14" Max
- Tire Diameter: 50" Max

Price Does Not
Include Tires or
Rims as Shown.

INCLUDES
Manufacturer's
Set-Up and Training

Lift Gate Service
SKU 262529
AMMLIFTGATE **55⁰⁰**

\$500
Factory Cash Back Rebate!
For Details Go to
www.rebate.ammcoats.com



APX90E Tire Changer

SKU OUTSIDE BUY/EPO
AMM85000222

15,749⁹⁹

- Large Clamping Capacity - Externally Clamps Wheels Up To 30" Or As Small As 9"
- Hi Torque Electric Turntable
- Three Position Bead Loosener
- Max Rim Width: 16" Maximum
- Max Tire Diameter: 44" Maximum

Available via
Outside Buy/EPO,
Call (1-877-258-6651)
for details.

Price Does Not
Include Tires or
Rims as Shown.

INCLUDES
Manufacturer's
Set-Up and Training

Lift Gate Service
SKU 262529
AMMLIFTGATE **55⁰⁰**

\$400
Factory Cash Back Rebate!
For Details Go to
www.rebate.ammcoats.com



Wheel Balancers

Digital Wheel Balancer

SKU 977528
RANDST2420

1,679⁹⁹

- Motor: 3/4 HP, 110V/220V 50/60 Hz, 1 Phase
- Balancing Modes: Dynamic/Static/3 Alloy
- Cycle Time: 6 to 9 Seconds
- Self-Calibrating
- Max. Tire Diameter: 47" / 1,194 mm
- Max. Tire Weight: 145 Lbs.
- Balancing Speed: 180 RPM
- Balance Increments: 0.25 or 0.01 oz
- Accuracy: + 1 Gram/.035 oz

INCLUDES
Wheel Weight
Starter Kit

Wheel Weight Starter Kit Includes One Bulk Roll of 100 Silver Adhesive Steel Tape Weights, One Bulk Roll of 100 Black Adhesive Steel Tape Weights and One Starter Box of Mixed Clip-On Steel Tape Weights

Lift Gate Service
SKU 262533
RANLIFTGATE **135⁰⁰**

Price Does Not
Include Tires or
Rims as Shown.



Digital Wheel Balancer

SKU 343398
RANDST-64T

2,449⁹⁹

- Ergonomic Control Board with Soft Touch Keys and Easy-to-Read LED
- Motor: 1.5 HP, 208 - 230V, 50/60 Hz, 1 Phase
- Maximum Tire Diameter: 50"
- Maximum Tire Weight: 150 Lbs.
- Cycle Time: 6 - 12 Seconds (Avg.) Depending On Wheel
- Precision-Machined, Hardened-Steel 36 mm Shaft

INCLUDES
Wheel Weight
Starter Kit

Wheel Weight Starter Kit Includes One Bulk Roll of 100 Silver Adhesive Steel Tape Weights, One Bulk Roll of 100 Black Adhesive Steel Tape Weights and One Starter Box of Mixed Clip-On Steel Tape Weights

Price Does Not
Include Tires or
Rims as Shown.



Lift Gate Service
SKU 262533
RANLIFTGATE **135⁰⁰**

DON'T FORGET THIS ACCESSORY



Truck Cone Kit
SKU 902536 RANRWS-ITC-1

249⁹⁹

• Works with Ranger Wheel Balancers Listed On This Page

Hofmann geodyna 7100 Car Wheel Balancer with LED Display

SKU 850058
HOFEEWB761A

3,399⁹⁹

- Combines High Accuracy with Small Footprint
- Semi-Automatic Input of Rim Diameter and Offset with Gauge Arm
- Short Balancing Cycle: 4.5 Seconds
- Rim Diameter: 8" - 32"
- Max Wheel Diameter: 37.8"
- Includes: Set of 4 Cones

Price Does Not
Include Tires or
Rims as Shown.

INCLUDES
On-Site Factory
Authorized Training

Lift Gate Service
SKU 290017
HOFLIFTGATE **95⁰⁰**

Warranty on All
Hofmann Balancers
5 Year Motor 3 Year Computer
1 Year Standard Parts
6 Months On-Site Labor



Hofmann Geodyna™ 7200s Wheel Balancer

SKU 467485
HOFEEWB746A

4,099⁹⁹

- Semi-Automatic Data Entry with Gauge Arm and SmartSonar
- Video Display
- Balance Time: 6 Seconds
- Includes: Set of 4 Cones with Drum, Ziplock Ring Nut, Rim Caliper and Weight Pliers

Price Does Not
Include Tires or
Rims as Shown.

INCLUDES
On-Site Factory
Authorized Training

Lift Gate Service
SKU 290017
HOFLIFTGATE **95⁰⁰**

Warranty on All
Hofmann Balancers
5 Year Motor 3 Year Computer
1 Year Standard Parts
6 Months On-Site Labor



Free Delivery!
in 48 Continental United States

Specifications Subject to Change Without Notice or Liability. Customers Responsible for Off-Loading Equipment Upon Arrival.

Leasing Terms Available.*
Ask Your AutoZone® Commercial Sales Manager.

**Delivery Included
on Tire Changers
and Wheel Balancers**



1-877-AZTool1 (1-877-298-6651) Hablamos Español

AutoZone Tool & Equipment QUARTERLY

Wheel Balancers

BaseLine 350 Wheel Balancer

SKU 818787
AMM85002350 **2,099⁹⁹**

- Manual Data Entry
- Foot Pedal Brake for Easy Weight Placement
- Self-Diagnosis and Self-Calibration
- One Button Split and Hidden Weight Program

BUY
300/350 COMBO
GET
\$200
FACTORY REBATE

Purchase the Tire Changer/
Balancer Combo and
Receive a \$200 Rebate!

\$200
Factory Cash Back Rebate!
For Details Go to
www.rebate.ammcoats.com



Price Does Not
Include Tires or
Rims as Shown.

BaseLine 550 Wheel Balancer

SKU 818786
AMM85002550 **2,799⁹⁹**

- Automatic Distance and Diameter Entry (2D)
- Direct Weight Location
- Direct Selection Ounce/Grams

BUY
500/550 COMBO
GET
\$400
FACTORY REBATE

Purchase the Tire
Changer/Balancer
Combo and
Receive a \$400
Rebate!

\$400
Factory Cash Back Rebate!
For Details Go to
www.rebate.ammcoats.com



Price Does Not
Include Tires or
Rims as Shown.

775 Wheel Balancer

SKU 210246
AMM85007775 **3,199⁹⁹**

- For Low to Medium Volume Shops
- Handles Assemblies Up to 100 Lbs.
- Integrated LED Matrix Display
- 10 Balancing Modes
- Self-Calibrating



Price Does Not
Include Tires or
Rims as Shown.

Lift Gate Service
SKU 262529
AMMLIFTGATE **55⁰⁰**

BASELINE ENTRY LEVEL
WHEEL BALANCER

User Setup Required.
Factory Authorized Service
Network Available.

**Comes with 1 Year
Parts Only Warranty**

Lift Gate Service SKU 262529
AMMLIFTGATE **55⁰⁰**

1100 Wheel Balancer (220V, 1 Phase)

SKU 527704
AMM85001100 **3,999⁹⁹**

- Shaft Diameter: 40 mm
- Maximum Tire Diameter: 44"
- Maximum Wheel Capacity: 150 Lbs.
- 220V, 1 Phase



Price Does Not
Include Tires or
Rims as Shown.

INCLUDES
Manufacturer's
Set-Up and Training

Lift Gate Service
SKU 262529
AMMLIFTGATE **55⁰⁰**

1150 Wheel Balancer (220V, 1 Phase)

SKU 527702
AMM85001150 **4,599⁹⁹**

- Auto Distance and Diameter Data Entry
- Behind the Spoke Mode
- 40 mm Shaft Diameter
- Maximum Tire Diameter: 44"



Price Does Not
Include Tires or
Rims as Shown.

INCLUDES
Manufacturer's
Set-Up and Training

\$400
Factory Cash Back Rebate!
For Details Go to
www.rebate.ammcoats.com

Lift Gate Service
SKU 262529
AMMLIFTGATE **55⁰⁰**

V200-3D Wheel Balancer with Laser

SKU 688221
AMM800V2003D **8,549⁹⁹**

- Touch-Free Operation for 85% of Wheel Balances
- Powered By Direct Drive and ProBalance Technology™
- Industrial-Grade Touchscreen
- Laser Guided Operation
- Reduces 80% of Unbalance Related Comebacks



Price Does Not
Include Tires or
Rims as Shown.

INCLUDES
Manufacturer's
Set-Up and Training

Lift Gate Service
SKU 262529
AMMLIFTGATE **55⁰⁰**

**Must be Purchased with
One of These 3 Adapter Kits:**

Basic Pro Adapter Kit
SKU 688219
AMM85609487 **624⁹⁹**

Extended Pro Adapter Kit
SKU 688220
AMM85609488 **1,224⁹⁹**

Premium Pro Adapter Kit
SKU 688222
AMM85609489 **2,349⁹⁹**

1250-2D Series 40mm Wheel Balancer

SKU 432078
AMM85606431 **5,899⁹⁹**

- Laser Guided Operation
- LED Display
- Tire Diameter: Up to 44"
- Rim Width 2" to 20"
- 220V/1PH



Price Does Not
Include Tires or
Rims as Shown.

INCLUDES
Manufacturer's
Set-Up and Training

Lift Gate Service
SKU 262529
AMMLIFTGATE **55⁰⁰**

**Must Be Purchased with
One of These 3 Adapter Kits:**

1250 Balancer Basic Passenger Car Coverage Kit - 40mm

SKU 432079
AMM8500997401 **519⁹⁹**

- Basic Kit for 1250 Series Balancer
- Covers Most OE Cars and Some OE Light Trucks
- Small Cone (1-3/4" to 2-1/4"), Medium Cone (2-1/4" to 3"), Large Cone (3" to 3-3/8"), Light Truck Back Cone, Premium Wheel Weight Hammer, Small Pressure Cup and Rubber Lip, Spring, Calipers, Hub Nut, Stub Shaft, Storage Pegs



1250 Balancer Extended Passenger Car Coverage Kit - 40mm

SKU 818743
AMM85009976 **1,124⁹⁹**

- Extended Kit for 1250 Series Balancer
- Covers Most OE Cars and OE Light Trucks
- Small Cone (1-3/4" to 2-1/4"), Medium Cone (2-1/4" to 3"), Large Cone (3" to 3-3/8"), Light Truck Back Cone, Wheel Weight Hammer, Hub Nut, Small Pressure Cup and Rubber Lip, Spring, Calipers, Stub Shaft, Storage Pegs, Short Cone, Light Truck Cone Kit 4.8" - 6.8", Faceplate Extension, Lip, Spring, Calipers, Hub Nut, Stub Shaft, Storage Pegs



1250 Balancer Premium Passenger Car and Light Coverage Kit - 40mm

SKU 818749
AMM85009977 **2,499⁹⁹**

- Premium Kit for 1250 Series Balancer
- Covers Most OE Cars, Light Trucks and Includes Pin Plates and Storage Rack
- Kit Includes: Small Cone (1-3/4" to 2-1/4"), Medium Cone (2-1/4" to 3"), Large Cone (3" to 3-3/8"), Light Truck Back Cone, Wheel Weight Hammer, Hub Nut, Small Pressure Cup and Rubber Lip, Spring, Calipers, Stub Shaft, Storage Pegs, Short Cone, Light Truck Cone Kit 4.8" - 6.8", Faceplate Extension, Pin Plates with Balancer Mate



Mount/Demount Heads

Fits On Models

Nylon Mount/Demount Head Kit with Round Hole
SKU 459195
TMRTC14024784 **99⁹⁹**



Accuturn 3602, 3602HP, 4260, 4560MR, 4602, 5602 and 5602 HP
Hofmann 1520, 1565, 1620, 1625EM, 3300, 3300EM, 1270, 2300, 3000 and 3000GP
John Bean EHP System IVE, IV, III, IIE
Snap On All Models

Coats Nylon Mount/Demount Head - Tapered Hole
SKU 459174
TMRTC20024335 **69⁹⁹**



Accuturn 3602, 3602HP, 4260, 4560MR, 4602, 5602 and 5602 HP
Hofmann 1520, 1565, 1620, 1625EM, 3300, 3300EM, 1270, 2300, 3000 and 3000GP
John Bean EHP System IVE, IV, III, IIE
Snap On All Models

Low Profile Mount/Demount Head
SKU 557259
TMRTC184432 **44⁹⁹**



Coats 5030, 5040, 5050, 5060, 5065, 6050, 6060, 6065, 7050, 7055, 7060, 7065, 7655, 7660 and 7665, BL200, BL300, BL400 and BL500

Tool Head for Hunter
SKU 557241
TMRTC14120 **49⁹⁹**



Hunter TCA34 with Serial Numbers 664 and Above

Mounting Flange for Demount Head (Flange Only)*
SKU 899502
RAN5150524 **59⁹⁹**



Red Nylon Mount/Demount Head

SKU 459185
TMRTC343 **39⁹⁹**



Fits On Models

Hunter TC250, TC300, TC325, TC350, TC2000, TC3250, TC3500, TC3000 and TC3100 Series
Accuturn (Require Adapter) 220A, All Other Models Require 102765 Adapter
Ranger R980X Rev A Models, R980XR/NXT, R30XLT, RX-850/950-B Models, R23/23ST, R26ST/26EX, R745 and R710 Models ONLY. Require RAN5150524 Adapter

Coats Nylon Mount/Demount Head - Tapered Hole
SKU 459183
TMRTC183061 **39⁹⁹**



Coats 5030, 5040, 5050, 5060, 5065, 6050, 6060, 7050, 7055, 7060, 7065, 7655, 7660 and 7665
Baseline BL200, BL300, BL400 and BL500

Nylon Mount/Demount Head Kit with Round Hole
SKU 459187
TMRTC250309 **99⁹⁹**



All Tool Coats Corghi Hofmann Sice All Models RC1, 5, 10, 15, 20, Early 5060, 9010, 9024 and APX90 All Rim Clamp Earlier Models Except 1550, 1620 and 1625 M39, S40, S42, S43, S45, S408MAXI, S435, S436 and S436TC

Coats Nylon Mount/Demount Head - Tapered Hole
SKU 459189
TMRTC450310 **69⁹⁹**



All Tool Coats Corghi Giuliano Hofmann Hunter Sice All Models RC1, 5, 10, 15, 20, Early 5060, 9010, 9024 and APX90 All Rim Clamp Shaft Needs to Be Turned 180 Degrees for This Head to Work Earlier Models Except 1550, 1620 and 1625 Fits All TCX Series (Earlier TCX500 Requires Upgrade Shaft and Kit RP11-8-114-00091) M39, S40, S41, S42, S43, S45, S408MAXI, S435, S436 and S436TOP

Free Delivery!
in 48 Continental United States

Specifications Subject to Change Without Notice or Liability.
Prices Do Not Include Vehicles, Installation or Optional Equipment as Shown.

Customers Responsible for Off-Loading Equipment Upon Arrival.
Ask Your Sales Rep for Details.

Leasing Terms Available.*
Ask Your AutoZone® Commercial Sales Manager.

TIRE SERVICE



Contact Us:
1-877-AZTool1 Phone
 (1-877-298-6651) *Hablamos Español*

SAVE \$150

No Need to Purchase Additional Scan Tool or Other Accessories. This Tool Functions at the Original Equipment Level on all Vehicles - Domestic, European and Asian

ATEQ

VT55 OBDII TPMS Diagnostic Tool

SKU 095059
 ATEVT55OBDII **1,099⁹⁹** REG: \$1249.99

- Simply Input Vehicle and Start TPMS Tests
- Complete Sensor Diagnostics - ID#, PSI, Temperature and Battery Status
- Triggers All OE Domestic and Import Sensors
- ECU OBDII Programming for Asian Vehicles
- No Scan Tool Required
- Free Technical Hotline Support
- Free Internet Updates for First Year



Offer Good Through September 30, 2016 While Supplies Last

TPMS Tools and Readers

TPMS Service Tool Kit

527699
 DYNDY-312



129⁹⁹

- Includes: Torque Wrench with 11 mm and 12 mm Sockets, Torque Tool for Valve and Sensor, Valve Core Torque Tool 12 In/Lbs., Grommet Removal Tool, Grommet Pick Tool



VT30 TPMS ID Reader

SKU 531172
 ATEVT30-1000

249⁹⁹

- Decode and Display All TPMS Sensors Currently On the Market, Your's Included
- Synchronize Through Internet Using a USB Connection On a PC



Diagnostic TPMS Tool

544586
 ATEVT56



1,699⁹⁹

- VT56 OBDII Kit Includes: VT56 Diagnostic Tool, OBDII Interface Connector, OBDII to VT56 Ethernet Cable, USB PC Cable, Power Adaptor, Update Software, Quickstart User Manual
- ATEQ Hard Kit Carry Case



MaxiTPMS[®] TS501K Diagnostic and Service Tool with 8 Sensors

850650
 AULTS501K

549⁹⁹

- Activates Sensors Using 125KHz Continuous or Modulated Wave Signals
- Programs Vehicle ECU to Learn Sensor IDs and Positions
- Capable of Programming Single Tires
- Reads/Clears Codes of TPM System
- Reset TPMS Malfunction Light
- Display Replacement Part Number



MaxiTPMS[®] TS401 Diagnostic and Service Tool

255740
 AULTS401

279⁹⁹

- Activates All Magnetic, Frequency, and Tire Deflation Sensors on All Vehicles
- Receives Both 315MHz and 433MHz Signals
- Reads Sensor ID, Tire Pressure, Temperature, Battery Condition, and OE Part Number
- Checks Remote Keyless Entry for Transmissions
- Provides Visual and Audible Responses to Confirm Sensors Are Working Properly
- Intuitive Navigation and Step-by-Step On-Screen Instructions
- Built-in Rechargeable Li-Polymer Battery
- One Year Free Online Software Updates and Multilingual Support
- Saves Up to 10 TPMS Records for Future Data Review
- Automatic Power-Off to Preserve Battery Life



Autel.us

315MHz / 433MHz Universal Programmable MX-Sensors

SKU 080038
 315MHz AULMXSENS315M

SKU 080039
 433MHz AULMXSENS433M

39⁹⁹

- Built to Perform like OE Sensors in Terms of Signal, Durability and Functionality
- Automotive Battery Grade to Meet Severe Weather Conditions
- High-Precision Air Valve to Prevent Air Leakage
- Replaceable Aluminum Valve Stem is Anodized for Corrosion Resistance
- Robust Clamp-in Pivoting Stem Design Allows for 0-35 Degree Angle Adjustment to Fit All Wheels Types
- The 2-SKU Sensor Solution Covering 98% of All OE Sensors



NEW



TECH 400 PRO TPMS Scan Tool

SKU760944
 WRT400PRO

1,699⁹⁹

- ✓ More OBD Relearns
- ✓ Wireless Updates
- ✓ TPMS Placard Adjusting
- ✓ Wireless Inductive Charging
- ✓ Passive Key System testing
- ✓ Includes TIA Inside Technology



Made in the U.K.!



Assembled in the U.S.A.!

TPMS TOOL TRADE UP!



TRADE UP AND MAKE MORE MONEY SERVICING TPMS!

HERE'S THE DEAL!

Do you have an old Bartec TPMS Tool? Maybe you have one of those "FREE TOOLS" given to you by a sensor distributor? Either way, this is a great opportunity to upgrade! Contact your local AutoZone store, or go to bartecusa.com/tpms-promotions.html to learn more about the \$800 in add-on items you can receive when trading in your old TPMS tool! Offer ends 9/30/2016, or while supplies last.

AUTEL MAXISYS

DIAGNOSTIC TOOL of the MONTH
AUGUST
 SEE INSERT FOR DETAILS

PLUS BONUS

FEATURES

TETHERED CABLE OBDII CONNECTOR

AULMS906

- COVERS US / ASIAN / EUROPEAN VEHICLES
- INSTANTLY RETRIEVES VEHICLE INFO
- OE-LEVEL VEHICLE COVERAGE & FUNCTIONS
- DETECT & DISPLAY FAULTS & TROUBLE CODES
- LIVE DATA VIEW / PRINT / STORE / PLAYBACK
- DEDICATED SERVICES SECTION - OIL SERVICE RESET, TPMS RELEARN, EPB, ABS/SRS, SAS
- FULL-SCREEN WAVEFORM GRAPHING ANALYSIS WITH TRIGGER-TYPE RECORDING MODES



SKU 040101

1,499.99

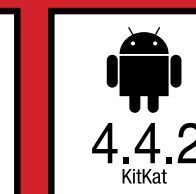
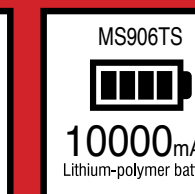
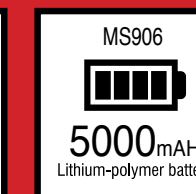
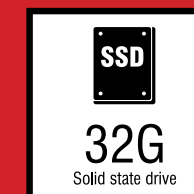
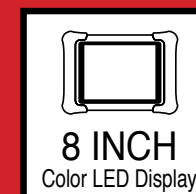
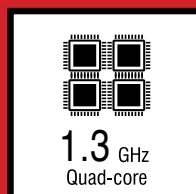

DID YOU KNOW?

There are over 120 million vehicles on the road with TPMS and that equates to almost 500 million sensors that will need to be replaced in the coming years.

Contact Your AutoZone Commercial Sales Manager for Details

AutoZone Tool & Equipment QUARTERLY

Wheel Weights



Complete Wheel Weight Program Available!

Call 1-877-AZTool1 or go to AZTool1.com for More Styles and Information.

Steel Wheel Weights

AZ SKU NUMBER	PART NUMBER	STYLE	QUANTITY	PRICE
382853	AMM025PFEPK4	PFE, 0.25 oz	4 Boxes of 25	23.99
382919	AMM050PFEPK4	PFE, 0.50 oz	4 Boxes of 25	24.99
382920	AMM075PFEPK4	PFE, 0.75 oz	4 Boxes of 25	28.99
382921	AMM100PFEPK3	PFE, 1.00 oz	3 Boxes of 25	27.99
382922	AMM125PFEPK3	PFE, 1.25 oz	3 Boxes of 25	31.99
382923	AMM150PFEPK3	PFE, 1.50 oz	3 Boxes of 25	34.99
382924	AMM175PFEPK3	PFE, 1.75 oz	3 Boxes of 25	37.99
382925	AMM200PFEPK3	PFE, 2.00 oz	3 Boxes of 25	39.99
382926	AMM225PFEPK2	PFE, 2.25 oz	2 Boxes of 25	29.99
382927	AMM250PFEPK2	PFE, 2.50 oz	2 Boxes of 25	31.99
382928	AMM275PFEPK2	PFE, 2.75 oz	2 Boxes of 25	32.99
382841	AMM025MCFEPK4	MCFE, 0.25 oz	4 Boxes of 25	30.99
382842	AMM050MCFEPK4	MCFE, 0.50 oz	4 Boxes of 25	34.99
382843	AMM075MCFEPK4	MCFE, 0.75 oz	4 Boxes of 25	38.99
382844	AMM100MCFEPK3	MCFE, 1.00 oz	3 Boxes of 25	33.99
382845	AMM125MCFEPK3	MCFE, 1.25 oz	3 Boxes of 25	38.99
382846	AMM150MCFEPK2	MCFE, 1.50 oz	2 Boxes of 25	30.99
383004	AMM025TFEPK4	TFE, 0.25 oz	4 Boxes of 25	30.99
383005	AMM050TFEPK3	TFE, 0.50 oz	3 Boxes of 25	27.99
383021	AMM025ALFEPK4	ALFE, 0.25 oz	4 Boxes of 25	30.99
383022	AMM050ALFEPK4	ALFE, 0.50 oz	4 Boxes of 25	34.99
383129	AMM25LHFEFK3	LHFE, 0.25 oz	3 Boxes of 25	25.99
383130	AMM50LHFEFK3	LHFE, 0.50 oz	3 Boxes of 25	27.99
383038	AMM10GFNFEFK3	FNFE, 10g	3 Boxes of 25	28.99
383039	AMM15GFNFEFK3	FNFE, 15g	3 Boxes of 25	30.99
383107	AMM10GFNFEFK4	ENFE, 10g	4 Boxes of 25	34.99
383108	AMM15GFNFEFK4	ENFE, 15g	4 Boxes of 25	37.99
383118	AMM10GIWFEFK4	IWFE, 10g	4 Boxes of 25	34.99
383119	AMM15GIWFEFK3	IWFE, 15g	3 Boxes of 25	30.99



Introducing Lead Wheel Weights*

BADA's Thinline Style Un-Coated Wheel Weights Are Designed for Steel Wheels On All Import and Domestic Passenger Cars, 1/2 Ton Trucks and All Mini Pickups and Vans with Standard .125" Flange

AZ SKU NUMBER	PART NUMBER	SIZE (OUNCES)	QUANTITY	PRICE
752047	AMM5522025PK4	0.25	4 Boxes of 50	26.99
752041	AMM5522050PK4	0.50	4 Boxes of 50	33.99
752042	AMM5522075PK4	0.75	4 Boxes of 50	45.99
752043	AMM5522100PK3	1.00	3 Boxes of 50	40.99
752044	AMM5522125PK3	1.25	3 Boxes of 50	50.99
752045	AMM5522150PK2	1.50	2 Boxes of 50	39.99
752046	AMM5522175PK2	1.75	2 Boxes of 50	49.99
752048	AMM5522100200	2.00	1 Box of 50	29.99
752051	AMM5522100225	2.25	1 Box of 50	34.99
752053	AMM5522100250	2.50	1 Box of 50	36.99
752065	AMM5522100275	2.75	1 Box of 50	36.99
752066	AMM5522100300	3.00	1 Box of 50	41.99



• Applications: Import and Domestic Cars and Light-Trucks with Steel Wheels

Tape-A-Weight® Steel Wheel Weight

AZ SKU NUMBER	PART NUMBER	SIZE (OUNCES)	QUANTITY	PRICE
019312	AMM5533601025	0.25	10 Lb. Roll	54.99
019310	AMM5533701050	0.50	10 Lb. Roll	54.99
019304	AMM5533600300	0.25	25 Strips - 12 Segments Each	44.99
019294	AMM5533700500	0.50	24 Strips - 10 Segments Each	54.99
019301	AMM5533800700	1.00	16 Strips - 7 Segments Each	54.99

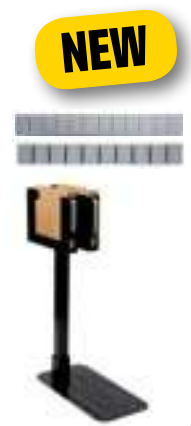

Tape-A-Weight Roll Dispenser

SKU 019292
AMM5310025
149.99
Stand only, Weights Not Included

Steel Weight Starter Kits

Metal Floor Rack with 1,700 Steel Weight Assortment

SKU 383179
AMM5202075 **799.99**

- Steel Rack, Application Chart, Header Card, Channel Cards, Rim Gauge, Premium Wheel Weight Hammer, Tape-a-Weight Scraper, 8 Styles of Wheel Weights: MCFE, ALFE, PFE, TFE, IWFE, FNFE, LHFE and INFE

Bench Top Rack with 1,000 Coated Steel Weight Assortment

SKU 383181
AMM5202125 **599.99**

- Louvered Rack Can Be Placed On Top of Any Work Bench
- Includes: Steel Rack, Application Guide, Header Card, Bin Labels, Rim Gauge, Wheel Weight Hammer, (5) Style Wheel Weights: PFE, ALFE, MCFE, TFE, FNFE, (40) Plastic Bins: (8) of Each: Yellow, Gray, Black, Red and Orange



SAVE \$10

8 Piece Wheel Stud Alignment Guide Kit

SKU 818715
24233 **24.99** REG: \$34.99



- Makes the Job Faster and Easier Allowing the Tech to Safely Position the Wheel Prior to Installing the Wheel Bolts
- Application: Mercedes, BMW, Audi, VW, Porsche, Fiat and Dodge
- Sizes Included: 12 mm x 1.5, 12 mm x 1.25, 14 mm x 1.25 and 14 mm x 1.75

Offer Good Through September 30, 2016 While Supplies Last

SAVE \$50

5 Gallon Bead Seater

SKU 526505
24449 **149.99** REG: \$199.99



- Seats Beads On All Tires, from Small 4" Tires to 24-1/2" Truck Tires
- Operates On Standard Shop Air; Max. 120 PSI
- Lip On Barrel Allows for Proper Angle for Correct Bead Seating

Offer Good Through September 30, 2016 While Supplies Last

Tire Service Tools

5 Piece Torque Limiting Extension Set (1/2" Drive)

SKU 965858
24220 **99.99**

- Quick, Simple and Accurate
- Helps Prevent Lug Stud/Nut Damage and Warped Rotors
- Includes 1/2" Drive Extensions: 65 Ft/Lbs., 80 Ft/Lbs., 100 Ft/Lbs., 120 Ft/Lbs. and 140 Ft/Lbs.



8 Piece Torque Limiting Extension and Thin Wall Socket Set (1/2" Drive)

SKU 347217
24228 **99.99**

- (4) Extension Bars: 65 Ft/Lbs. (90 nm), 90 Ft/Lbs. (120 nm), 100 Ft/Lbs. (135 nm) and 110 Ft/Lbs. (150 nm)
- (4) Deep Sockets: 17, 19, 21 and 22 mm



While Supplies Last

Wheel Weight Hammer Tool

SKU 217378
25690 **22.99**

- Tool Installs, Removes, Trims and Tightens All Types of Clip-On Wheel Weights
- Features a Special Plastic Material On Hammer Head for Safe, Mar-Free Installation of Specially Coated Wheel Weights Used On Alloy Wheels

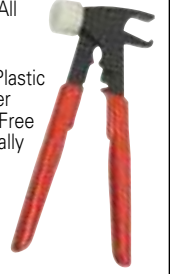

10 Piece Torque Limiting Socket Set (1/2" Drive)

SKU 965855
24221 **199.99**

- Prevents Under and Over Torquing
- Includes: 17 mm x 55 Ft/Lbs. 17 mm x 80 Ft/Lbs. 21 mm x 80 Ft/Lbs. 19 mm - 3/4" x 100 Ft/Lbs. 19 mm - 3/4" x 65 Ft/Lbs. 19 mm - 3/4" x 80 Ft/Lbs. 22 mm - 7/8" x 120 Ft/Lbs. 22 mm - 7/8" x 140 Ft/Lbs.



3 Piece, Extra Thin Wall, Wheel/Nut Protector Impact Socket Set (1/2" Drive)

SKU 094646
25583 **24.99**

- 17 mm / 11/16" - Blue
- 19 mm / 3/4" - Yellow
- 21 mm / 13/16" - Red



9 Piece, Extra Thin Wall, SAE and Metric Wheel Protector Impact Socket Set (1/2" Drive)

SKU 965856
24224 **79.99**

- Hard Plastic Sleeve and Insert Protects Expensive Wheels and Lug Nuts from Damage
- Sizes: 3/4", 7/8", 13/16", 15/16", 1", 1-1/16", 17 mm, 19 mm and 21 mm



4 Piece, Deep Thin Wall, SAE and Metric Impact Flip Socket Set (1/2" Drive)

SKU 965857
24223 **24.99**

- Includes 3/4" - 13/16", 19 mm - 21 mm and 7/8" - 15/16" Sockets and 3" Extension



9 Piece Wheel Lock Removal Impact Socket Set (1/2" Drive)

SKU 965865
24225 **49.99**

- Includes: GM Hubcap Lock Remover, GM Sprocket Hubcap Remover, Ford and Chrysler Hubcap Lock Remover, Large Universal Locking Lug Nut Remover, Large Wheel Cover Lock Remover, Remover for Stripped 18 mm Lug Nuts, GM "M" and "F" Body Wheel Lock Remover and Lug Nut Remover Punch



3 Piece Super Strength Wheel Nut Impact Socket Set (1/2" Drive)

SKU 347212
24227 **49.99**

- Color Coded for Easy Size Identification Blue - 17 mm, Gold - 19 mm and Red - 21 mm



16 Piece Locking Lug Master Key Set

SKU 626107
24447 **99.99**

- Easily Removes Locking Lug Nuts On Most Aftermarket Wheels
- Thin Wall Sockets Prevent Damaging Wheels and Lugs
- Double Hex-Head Design Fits Most Lug Wrenches As Well As 13/16" and 7/8" Sockets
- Chart Included
- Comes in a Blow Mold Case



Wheel Stud Installer

SKU 222512
LIS22800 **31.99**

- Easily Installs New Wheel Studs
- Use with a Ratchet or Impact Wrench to Pull the New Stud Securely in Place
- Works On Most Automotive and Light Duty Truck Wheel Studs, Foreign and Domestic



Truck Wheel Stud Installer

SKU 222516
LIS28950 **36.99**

- Installs Most Truck Wheel Studs in Seconds
- Use with an Impact Wrench or Ratchet
- Thrust Bearing Easily Pulls the New Wheel Stud into Place
- Fits Truck Wheel Studs Up to 22 mm (7/8") in Diameter

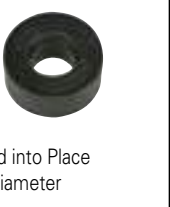

2 Piece Valve Core Tool Set

SKU 255622
VCTSET **14.99**

- For Inserting or Removing Valve Cores
- Ergonomic Shaped Handles that Provide Firm Grip
- Includes 2" and 4" Tools



Spare Tire Removal Tool Kit

SKU 479984
THX497X **144.99**

- Kit Includes a Hand Crank and (6) Different Zinc Plated Steel Tools to Fit Most Pick-Ups, Vans and SUV-Type Vehicles
- Kit is Complete in Heavy Nylon Pouch that Fits Easily Behind the Seat in the Truck or in the Tool Box



Tire Tube Test Tank

SKU 291382
LIS19822 **69.99**

- Tank Features Reinforcement Ribs for Extra Support
- Will Handle Passenger Tire Sizes to Wide Oval and Light Duty Truck Tires
- Dimensions: 31" (L) 12" (W) 12" (H)



AUTOMOTIVE LIFTS

2 Post Lifts

10,000 Lbs. F10 2 Post Lift

SKU 818779
FORF10I00MBL **2,599⁹⁹**

- Low Profile/Oversized Pads to Raise Most Vehicles
- 3 Stage Front Arms for Symmetric and Asymmetric Lifting
- Includes (4) 3.5" and 5" Adapter Extenders
- Warranty: 60 Days Labor, 18 Months Parts, 5 Years Structural

Price Does Not Include Installation or Optional Equipment as Shown.



10,000 Lbs. Dual Width Clearfloor 2 Post Lift

Symmetric
SKU 210257
BENXPRI0 **2,999⁹⁹**

Asymmetric
SKU 210249
BENXPRI0A **3,099⁹⁹**

Low Profile Arm
SKU 557238
BENXPRI0LP **3,099⁹⁹**

Asymmetric Low Profile Arm
SKU 557237
BENXPRI0ALP **3,099⁹⁹**



- Lifting Capacity: 10,000 Lbs.
- Rise: 69"
- Overall Height: 145"
- Overall Width: 132" - 145"



Five Years (60 Months) Warranty on the lift structure
Two Years (24 Months) Warranty on the hydraulic cylinder(s) and power unit
One Year (12 Months) Warranty on operating components
One Year (12 Months) Labor Warranty on site or at factory
One Year (12 Months) Free-Shipping* on ground-freight charges related to warranty performance
*Free-shipping applies to direct shipping points within the 48 continental United States. Rural area shipping surcharge may apply for remote addresses. See BendPak.com for specific terms of warranty.

Challenger SA10 10,000 Lbs. 2 Post Vehicle Lift

SKU 847098
CHLSA10 **2,899⁹⁹**

- Can Be Configured in Either the Symmetric or Asymmetric Position
- 3 Stage Front Arms Provide Greater Overall Arm Sweep
- Double Telescoping Screw Pads to Minimize the Need for Adapters

Price Does Not Include Vehicles, Installation or Optional Equipment as Shown.



10,000 Lbs. 2 Post Lift

SKU 298485
CHLCL10V3 **4,199⁹⁹**

Versymmetric 3 Stage Arms

- Column Height: 11' 3"
- Adjustable Width Overall: 11' 6-1/2" / 11' 11"
- Floor to Overhead Switch: 134.5"
- Ceiling Height Required: 11' 11"
- Drive-Thru Clearance: 100" / 104-1/2"



Price Does Not Include Vehicles, Installation or Optional Equipment as Shown.

10K Truck Adapter Set

SKU 263557 | CHL10315 **264⁹⁹**



Frame Cradle Adapter Set

SKU 263785 | CHL10318 **224⁹⁹**



Works with Challenger 10K Lifts Only
Offer Good Through September 30, 2016 - While Supplies Last

10,000 Lbs. 2 Post Lift

SKU 264325
CHLQ10 **2,599⁹⁹**

- Height Overall: 12' 3-1/2" or 11' 5-1/2"
- 3 Stage Front Arm and 2 Stage Rear Arms
- Lifts Symmetrically and Asymmetrically

BONUS Value: \$264.99

10K Truck Adapter Set

SKU 263557 | CHL10315



with Purchase of:
10,000 Lbs. 2 Post Lift
SKU 264325 | Part# CHLQ10



Price Does Not Include Vehicles, Installation or Optional Equipment as Shown.
Offer Good Through September 30, 2016 - While Supplies Last

10,000 Lbs. 2 Post Lift

SKU 499657
FORI10 **2,899⁹⁹**

- Low Profile 3-5/8" Min. Adapter Height
- Spot-Rite™ 3 Stage Front Arms for Symmetric and Asymmetric Lifting
- Overall Height: 143-3/8"
- Overall Floor Width: 137"
- Maximum Lifting Height: 76"
- Inside Column Width: 115"
- Drive Through Clearance: 105"
- Minimum Ceiling Height: 144"

Leasing Terms Available.†

Ask Your AutoZone® Commercial Sales Manager.

Free Delivery!

in 48 Continental United States



Price Does Not Include Vehicles, Installation or Optional Equipment as Shown.

10,000 Lbs. 2 Post Lifts

SKU 534581
ROTSPA10 **4,149⁹⁹**

Asymmetrical

SKU 210371
ROTSP010 **4,149⁹⁹**

Symmetrical

- Surface Mounted, Frame Contact Lift
- Features Electric Hydraulic Operation and Genuine Symmetrical Design for Overhead Design for Clear Floor Lift
- Factory Rotated Columns Allow Doors of Vehicle to Be Fully Opened While Properly Positioned On Lift
- Arm Restraints On All Arms

Symmetrical Column Orientation

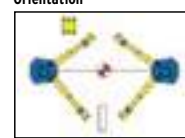

Asymmetrical Column Orientation

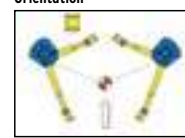

We Carry the Full Line of Rotary Lifts!
Call 1-877-AZTool1 for Details.



Price Does Not Include Vehicles, Installation or Optional Equipment as Shown.

12,000 Lbs. F12N300 2 Post Lift

SKU 818751
FORF12N300BL **4,599⁹⁹**

- 2 Stage Arms Reach: 35" to 54"
- Accommodates Trucks and Many Cars
- Low Profile 4-3/4" Adapters
- Includes Four 3.5" and 5" Adapter Extenders
- Height Configurations of 11' - 10", 12' - 10", and 14' - 10" Are Available
- Warranty: 60 Days Labor, 18 Months Parts, 5 Years Structural

Leasing Terms Available.†

Ask Your AutoZone® Commercial Sales Manager.

Free Delivery!

in 48 Continental United States



Price Does Not Include Installation or Optional Equipment as Shown.

15,000 Lbs. Clearfloor, Standard Arms Lift

SKU 897976
BENXPR-15C **7,449⁹⁹**

- Lifting Capacity: 15,000 Lbs.
- Overall Height: 170"
- Overall Width: 155"
- Minimum Pad Height: 5"
- Rise: 69"
- Rise Time: 45 Seconds
- Motor: 220 VAC/1 Ph

(Truck Adapters Included)

Price Does Not Include Vehicles, Installation or Optional Equipment as Shown.



Brigadier 10ACK 2 Post Lift

SKU 186433
DAN1375647 **2,649⁹⁹**

Asymmetric

- Lifting Capacity: 10,000 Lbs./4,546 Kg
- Overall Height: 145" / 3,683 mm
- Overall Width (Outside of Base Plates): 143-1/2"
- Overall Width (Outside of Columns): 136-1/2"
- Width Between Columns: 112-3/4"
- Minimum Reach (Front Arm): 25"/635 mm
- Maximum Reach (Front Arm): 46"/1,168 mm
- Minimum Reach (Rear Arm): 42"/1,067 mm
- Maximum Reach (Rear Arm): 60"/1,524 mm
- Minimum Pad Height: 4-1/2"/114 mm
- Rise: 69"/1,753 mm
- Maximum Lifting Height (Pad Only): 73"/1,854 mm
- Maximum Lifting Height (Pad and 6" Adapter): 79"/2,007 mm
- Drive Thru Clearance: 100-1/2"
- Motor: 220 VAC 60Hz. 1Ph

(Truck Adapters Included)



Price Does Not Include Vehicles, Installation or Optional Equipment as Shown.

Hofmann 10,000 Lbs. 2 Post Lift

SKU OUTSIDE BUY/EPO
HOFEELR731A **2,999⁹⁹**

- Vehicles Can Be Positioned and Lifted Symmetrically or Asymmetrically
- Overall Height Can Be Adjusted 10"
- Power Column Can Be Arranged On Either the Driver or the Passenger Side
- Three Stage Front Arms Provide Superior Extended and Retracted Reach

Available via Outside Buy/EPO, Call (1-877-298-6651) for details.



Price Does Not Include Vehicles, Installation or Optional Equipment as Shown.

BONUS Truck and Frame Cradle Adapters

Value: **\$489.98**



with Purchase of:
12,000 Lbs. 2 Post Lift
SKU 264341 | Part# CHLQ12

Offer Good Through September 30, 2016 - While Supplies Last

12,000 Lbs. 2 Post Lift

SKU 264341
CHLQ12 **4,199⁹⁹**

- Height Overall: 14' 7" or 13' 10"
- Width Overall: 139-3/4"
- Drive Thru Clearance: 101"
- Rubber Door Protector Padded Overhead Safety Switch
- Floor to Overhead: 13' 3-1/2" or 14' 5"
- 2 Stage Front and Rear Arms for Symmetric Lifting



Price Does Not Include Vehicles, Installation or Optional Equipment as Shown.

12,000 Lbs. Clearfloor Triple-Telescope Arms Lift

SKU 897974
BENXPR-12C **4,899⁹⁹**

- Triple-Telescope Arms-All Four to Easily Lift Your Largest Full-Size Pick Ups and Commercial Vehicles, Yet Still Provide Specific Capability for Sport and Compact Cars
- Overall Height: 170"
- Overall Width: 155"
- Min Pad Height: 5"

Price Does Not Include Vehicles, Installation or Optional Equipment as Shown.



(Truck Adapters Included)

15,000 Lbs. 2 Post Lift

SKU 499669
FORDP015 **7,599⁹⁹**

- Includes Four 4" and Four 8" Truck Adapter Extensions

Price Does Not Include Vehicles, Installation or Optional Equipment as Shown.



Free Delivery!
in 48 Continental United States

Specifications Subject to Change Without Notice or Liability. Customers Responsible for Off-loading Equipment Upon Arrival.
Prices Do Not Include Vehicles, Installation or Optional Equipment as Shown.

Leasing Terms Available.†
Ask Your Sales Rep for Details.
Ask Your AutoZone® Commercial Sales Manager.

Leasing Terms Available!+

Ask Your AutoZone®
Commercial Sales Manager

AutoZone
Tool & Equipment **QUARTERLY**

2 Post Floor Plate Lifts

**9,000 Lbs. 2 Post Lift
Low Profile Arm**

SKU 557232
BENXPR9LP **3,099⁹⁹**

- Low-Pro™ Arms that Accommodate Lowered Sports Cars and Those Vehicles with Lift Points Located On the Extreme Outer Edges of the Chassis
- Shorter Column for Low Ceiling Installations
- Column Height: 113"
- Extended Rise Gives You Over 6' of Under Clearance



(Truck Adapters Included)

Price Does Not Include Installation or Optional Equipment as Shown.

**9,000 Lbs. 2 Post
Low Ceiling Lift**

SKU 210379
BENXPR-9F **3,099⁹⁹**

- 9,000 Lbs. Lifting Capacity
- Short Column for Low Ceiling Installations
- Wide or Narrow Configuration
- Single Piece Columns
- Single Point Safety Release Drop End Arms Provide a Lower Pad Height



(Truck Adapters Included)

Price Does Not Include Vehicles, Installation or Optional Equipment as Shown.

9,000 Lbs. 2 Post Lift

SKU 499660
FORBP9 **3,199⁹⁹**

- Minimum Ceiling Height: 113"
- Overall Width: 138-1/2" (3,518 mm)
- Overall Height: 111-1/4" (2,826 mm)
- Minimum Adapter Height: 3-1/2"
- Adapter Extenders Included
- ETL Certified



Low Ceilings Are No Problem!

Price Does Not Include Installation or Optional Equipment as Shown.

**Challenger CLFP9
9,000 Lbs. Floor
Plate 2 Post Lift**

SKU 851779
CHLCLFP9 **3,399⁹⁹**

- 3 Stage Front and Rear Arms Provide Excellent Reach to Lift a Variety of Vehicles
- Drive-Thru Clearance: 98-3/16"
- Ceiling Height Required: 121-7/8"



Price Does Not Include Vehicles, Installation or Optional Equipment as Shown.

**12,000 Lbs. Floorplate
Direct-Drive Lift**

SKU 897973
BENXPR-12FD **4,779⁹⁹**

- Lifting Capacity: 12,000 Lbs.
- Overall Height: 170"
- Overall Width: 155"
- Minimum Pad Height: 5"
- Rise: 69"
- Rise Time: 45 Seconds



Price Does Not Include Vehicles, Installation or Optional Equipment as Shown.

**Admiral 9,000 Lbs.
2 Post Lift Extended**

SKU 186430
DANI375646 **2,649⁹⁹**

- Perfect for Shops and Garages with Height Restrictions
- Truck and Van Adapter Set Included



Price Does Not Include Vehicles, Installation or Optional Equipment as Shown.

Quick Lifts: Rise Time 45 Seconds!

**CL10 Versymmetric 10,000
Lbs. 2 Post Dual Pendant
Controls Quick Cycle Lift**

SKU 851780
CHL10V3DPCQC **5,749⁹⁹**

- Quick Cycle Technology: Increased Rise of Speed to 27 Seconds from 48 Seconds Equating to a 42% Time Savings Lowering Speed Is Held to a Constant 17 Seconds (Approximately) Regardless of the Weight of the Vehicle
- Up/Down Power Button + Dual Single Point Technical Lock Release System Provides Lift Operation from Either Column



Price Does Not Include Vehicles, Installation or Optional Equipment as Shown.

**Express Solution CL10-XP9
10,000 Lbs. Quick Cycle 2
Post Pad Lift**

SKU 851786
CHLCL10XP9QC **7,249⁹⁹**

- CL10-XP9 2 Post Pad Lifts Come Standard with (4) 1-1/2" and (4) 3" Rubber Spotting Blocks and (4) Two Position Adapter Blocks
- Quick Cycle Technology Means 43% Faster Rise Time



Price Does Not Include Vehicles, Installation or Optional Equipment as Shown.

Storage Lifts

**9,000 Lbs. Free
Standing or Surface
Mounted 4 Post Lift -
Standard Height**

SKU 264504
CHLQ4P09H **3,499⁹⁹**

- Rise Height to Top of Runway: 73-1/2"
- Outside to Outside Columns: 112"
- Overall Length (with Ramps Attached): 209"
- Inside Columns: 95"
- Height of Columns: 84-1/2"
- Width of Runways: 20"
- Height of Runways: 7"
- Width Between Runways: 38"
- Length of Runways: 164"



Price Does Not Include Vehicles, Installation or Optional Equipment as Shown.

Caster Set
SKU 264473
CHLQ4P09CS **229⁹⁹**

Rolling Jacks Sold Separately.

WORKS WELL WITH

**4,500 Lbs. Hand/Hydraulic
Operated Rolling Jack**

SKU 264841
CHLQRJ04H **899⁹⁹**



(Optional Equipment)

**9,000
Lbs. 4 Post Lift**

SKU 898142
BENHD-9 **2,999⁹⁹**

- Overall Width: 116-3/4" / 2,965 mm
- Overall Length: 200" / 5,080 mm
- Column Height: 88" / 2,235 mm
- Max. Lifting Height: 74-1/2" / 1,892 mm



Price Does Not Include Vehicles, Installation or Optional Equipment as Shown.

Rolling Jacks Sold Separately.

WORKS WELL WITH

**RJ-45 4,500 Lbs.
Capacity Rolling
Bridge Jack**

SKU 898534
BENRJ-45 **1,149⁹⁹**



(Optional Equipment)

**8,000 Lbs.
EFP8 Home
Storage 4 Post Lift**

SKU 818781
FOREFP8P000M **2,799⁹⁹**

- Perfect for Home Use
- Detachable Ramps Included
- Casters, Jack Tray and Drip Trays Included
- Wired to Plug into 115V Receptacle



Price Does Not Include Vehicles, Installation or Optional Equipment as Shown.

Rolling Jacks Sold Separately.

WORKS WELL WITH

**3,500 Lbs. RJ35BK Hand
Pump Rolling Jack**

SKU 818764
FORRJ35BK **699⁹⁹**



(Optional Equipment)

**7,000 Lbs. 4 Post
Home Storage /
Light-Duty Service Lift**

SKU 383185
CHLQ4P07 **3,199⁹⁹**

- Rise Height Underneath Runway: 63"
- Outside to Outside Columns: 100"
- Overall Length (with Ramps): 195 1/2" (w/o Ramps) 165"
- Inside Columns: 92"
- Height of Columns: 79-1/2"
- Width of Runways: 20"
- Height of Runway: 4"
- Width Between Runways: 38"
- Length of Runways: 150"
- Detachable Aluminum Approach Ramp Length: 36"
- 13 Lock Positions
- Pre-Assembled Lock Mechanism
- 1HP 110 Volt Plug-In or 220V Power



Price Does Not Include Vehicles, Installation or Optional Equipment as Shown.

WORKS WELL WITH

**4,500 Lbs. Hand/Hydraulic
Operated Rolling Jack**

SKU 383186
CHLQRJ03H **599⁹⁹**



(Optional Equipment)

BONUS Set of 3 Drip Trays
SKU 186439 Part# DANI01011
Value: \$69.99

with Purchase of:
**Commander™
7,000 Lbs.
4 Post Lift**
SKU 186464 Part# DANI375643

Offer Good Through September 30, 2016 - While Supplies Last

**Commander™
7,000 Lbs. 4 Post Lift**
SKU 186464
DANI375643
2,599⁹⁹

- Spring-Loaded Safety Locks On Each Column
- Self-Lubricating UHMW Polyethylene Internal Slide Blocks
- Single Safety Lock Release Handle
- 7,000 Lbs. Capacity Free Standing Design
- Detachable Drive-Up Ramps Included

Price Does Not Include Vehicles, Installation or Optional Equipment as Shown.

Free Delivery! in 48 Continental United States | **Specifications Subject to Change Without Notice or Liability.** | **Customers Responsible for Off-loading Equipment Upon Arrival.** | **Leasing Terms Available!** Ask Your AutoZone® Commercial Sales Manager. Ask Your Sales Rep for Details.

AUTOMOTIVE LIFTS

4 Post Lifts

9,000 Lbs. 4 Post Lift
SKU 499672 **3,499⁹⁹**
FOREFP9

- Includes: Steel Approach Ramps, Jack Tray, Wheel Caster Kit and Drip Trays
- Single Point Lock Release
- Internal Lock System
- ETL Certified



Rolling Jacks Sold Separately.

WORKS WELL WITH

Price Does Not Include Vehicles, Installation or Optional Equipment as Shown.

4,500 Lbs. Rolling Jack
SKU 568432 **999⁹⁹**
FORRRJ45G

(Optional Equipment)



Major D-12™ 12,000 Lbs. 4 Post Lift

SKU 343410 **3,799⁹⁹**
DAN1375681

Dannmar
EQUIPMENT

- Single Hydraulic Cylinder Mounted Underneath Runway
- Internal "Anti-Sway" Slider Blocks in Each Column
- Features Heavy Duty 1/2" Aircraft Cable
- Oversized Self-Lubricating Cable Rollers
- Rugged 1-3/8" Roller Axles
- Multi-Position Safety Locks in Each Column
- Ramps Feature Non-Skid Surface Column
- Push-Button Safety Release
- Runways Adjust for Different Tread Widths

Price Does Not Include Vehicles, Installation or Optional Equipment as Shown.



WORKS WELL WITH

Rolling Jacks Sold Separately.



SCAN FOR DETAILS

4 Post Rolling Bridge Jack DRJ-6
SKU 343411 **1,199⁹⁹**
DAN1375901

(Optional Equipment)



14,000 Lbs. 4 Post Lift

SKU 898152 **4,299⁹⁹**
BENHDS14

BendPak

- Overall Width: 130"
- Overall Length: 241"
- Max. Rise: 70"
- Motor: 220 VAC/1 Ph

Price Does Not Include Vehicles, Installation or Optional Equipment as Shown.



WORKS WELL WITH

Rolling Jacks Sold Separately.

(Shown with Optional Equipment)

RJ-7 7,000 Lbs. Capacity Rolling Bridge Jack
SKU 212556 **1,269⁹⁹**
BENRJ-7

(Optional Equipment)



14,000 Lbs. 4 Post Lift

SKU 696483 **4,499⁹⁹**
FORCR14N100

- Heavy Duty Hydraulic Cylinder
- Single Point Latch Release System
- 78-3/4" Rise
- 18 Lock Positions
- Accommodates 182.5" Wheelbase Vehicles
- High Performance Cable and Sheave System
- ETL Certified - Model Shown Is CR14N100

FORWARD
LIFT



Price Does Not Include Installation or Optional Equipment as Shown.

WORKS WELL WITH

Rolling Jacks Sold Separately.

Challenger 4P14 14,000 Lbs. 4 Post Lift

SKU 851781 **5,599⁹⁹**
CHL4P14EFX

Challenger Lifts

- Louvered Approach Ramps for Positive Vehicle Traction
- Adjustable Runways to Accommodate a Variety of Tread Widths
- Column Height: 90-1/2"
- Minimum Bay Size: 12' x 24'

Price Does Not Include Vehicles, Installation or Optional Equipment as Shown.



WORKS WELL WITH

Rolling Jacks Sold Separately.

18,000 Lbs. 4 Post General Service Lift

SKU 568426 **7,999⁹⁹**
FORCR18

- Max. Wheelbase: 194"
- Durable Cable and Sheave System
- ETL Certified to ANSI/ALI ALCTV: 2011

FORWARD
LIFT



WORKS WELL WITH

Price Does Not Include Vehicles, Installation or Optional Equipment as Shown.

Rolling Jacks Sold Separately.

18,000 Lbs. Long Wheelbase 4 Post Lift

SKU 568427 **8,799⁹⁹**
FORCR18LW

- Max. Wheelbase: 230"

WORKS WELL WITH

7,000 Lbs. Rolling Jack
SKU 568445 **1,999⁹⁹**
FORRRJ70G

(Optional Equipment)



7.7K Rolling Jack
SKU 264847 **2,299⁹⁹**
CHLRJ75

(Optional Equipment)



9,000 Lbs. Rolling Jack
SKU 568446 **2,999⁹⁹**
FORRJ901000

(Optional Equipment)



2 Post Lift Accessories

Rubber 2 Post Lift Pad/Slip Over/Round - 1 Each

SKU 343396 **24⁹⁹**
BEN5715017

- Slip Over Rubber Lift Pad for Use with Bendpak 2 Post Lifts with Round Flat Contact Pads. Sold Individually

BendPak



I10 2 Post Carriage Door Bumper Kit

SKU 568451 **59⁹⁹**
FORTPB10-D1

- Use with Forward FORI10

FORWARD
LIFT



Round Rubber Lift Pad Assembly Drop-In (1 Each)

SKU 343397 **79⁹⁹**
BEN5215507

- Works with Any BendPak 2 Post Lift
- 1 Lift Pad
- 5" Diameter for Enhanced Stability
- Easy Drop-In Design

FORWARD
LIFT



Square Rubber Arm Pads (1 Each)

SKU 898880 **29⁹⁹**
BEN5715365

- Works with Any BendPak 2 Post Lift
- 5-5/8" Square
- 1-1/16" Thick

BendPak

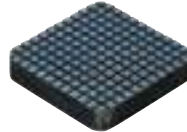

Frame Cradle Pad (1 Each)

SKU 466304 **49⁹⁹**
BEN5215506

- Perfect for Use with Any BendPak 2 Post Lift
- Tactile Rubber Mat Reduces Slippage and Protects Finish

BendPak



Dannmar Frame Cradle Pad (1 Each)

SKU 289999 **49⁹⁹**
DAN119527

Dannmar
EQUIPMENT



I10 Rubber Adapter Pad Kit

SKU 568440 **99⁹⁹**
FOR994105

- Use with Forward FORI10
- Eliminates Metal to Metal Contact at Vehicle Lift Points
- Includes (4) Pads and Attaching Hardware

FORWARD
LIFT



I10 2 Post Lift Adjustable Adapters (Set of 4)

SKU 568450 **299⁹⁹**
FORT100285

- Use with Forward FORI10
- Included Rubber Pad Eliminates Metal to Metal Contact
- Adapters Have Ears to Cradle Frames

FORWARD
LIFT



Don't Let the Tire Make You Tired!

Omega Wheel Arm™

SKU 573207 **89⁹⁹**
OMG92100

- Holds the Tire at Lift Arm Height and Is Handy with Tire Rotations and Brake Jobs
- Easy and Safe for Mechanics to Put On or Take Off Tires
- Avoid Bending Over to Put Down or Pick Up a Tire
- Fits Most Lift Arms 3" - 5" Wide
- Set Includes (2) Wheel Arms and (2) Magnetic Tool Trays



Price Does Not Include Tires or Rims as Shown.

INCLUDES:
2 Round Magnetic Trays

Set of 2

\$19⁹⁹ Value

While Supplies Last



4 Post Lift Accessories

2 Drip Trays

SKU 301768 **69⁹⁹**
BEN5700301



Caster Wheel Set

SKU 898905 **299⁹⁹**
BEN5210997

- For Use On HD-9 Series Lift Only

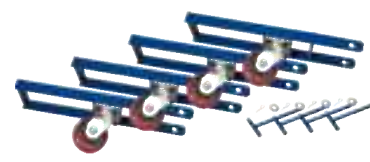

Rolling Oil Drain

SKU 898714 **379⁹⁹**
BENDP-30

- Adjustable Width: 33" - 60"



Free Delivery!
in 48 Continental United States

Specifications Subject to Change Without Notice or Liability.
Prices Do Not Include Vehicles, Installation or Optional Equipment as Shown.

Customers Responsible for Off-loading Equipment Upon Arrival.
Ask Your Sales Rep for Details.

Leasing Terms Available.*
Ask Your AutoZone® Commercial Sales Manager.

Leasing Terms Available!†

Ask Your AutoZone®
Commercial Sales Manager

AutoZone®
Tool & Equipment QUARTERLY

TUXEDO
Distributors, LLC.
Automotive Equipment & Accessories

Tuxedo Distributors, LLC, is a leading importer of high quality automotive repair equipment offering a full line of automotive equipment at an economical price. With our 15 satellite warehouses strategically located across the US, we offer an unparalleled competitive advantage.

Approved Outside Buy Vendor

Call to place order!

817.558.9337

877.558.9337 Toll Free

TWO POST LIFTS

TLT240SC
9,000lbs CAPACITY **2,099⁹⁹**

TLT240SB
9,000lbs CAPACITY **1,999⁹⁹**

- 9,000 lb. lifting capacity
- Overall Height: 151" (TLT240SC)
- Overall Width: Symm 134", Asymm 140" (TLT240SC)
- Overall Height: 113" (TLT240SB)
- Overall Width: 133" (TLT240SB)
- Rubber Door Guards
- Hose Guards
- Dual Point Lock Release
- Heavy-Duty Arm Restraint System
- Double Telescoping Screw Pads
- Adjustable Column Width (TLT240SC)
- Standard or Rotated Asymmetric Columns (TLT240SC)

LAUNCH



TP9KAC
9,000lbs CAPACITY **1,949⁹⁹**

TP9KF
9,000lbs CAPACITY **1,949⁹⁹**

- 9,000 lb. lifting capacity
- Overall Height: 142" (TP9KAC)
- Overall Width: 141" (TP9KAC)
- Overall Height: 111-1/2" (TP9KF)
- Overall Width: 141" (TP9KF)
- Chain Driven
- Dual cylinders with low friction chain rollers
- Low profile arms
- 1-1/2" and 5" stackable drop-in height adapters
- Automatic safety cut-off bar (TP9KAC)
- Mounting Hardware included
- Powder-Coated Finish



TLT210-XT
10,000lbs CAPACITY **2,799⁹⁹**

- 10,000 lb. lifting capacity
- Overall Height: 149"
- Overall Width: Symm 137", Asymm 138"
- Heavy-Duty Arm Restraint System
- Adjustable Column Height
- Adjustable Column Width
- Outer Hose Guards
- Stackable Foot Pad Extensions two 6" and two 3"
- 3 Stage Front Arms
- Rubber Door Guards
- Single Point Lock Release
- Standard or Rotated Asymmetric Arm Configuration
- Double Telescoping Screw Pads offering 6.5" adjustment for complete vehicle coverage

LAUNCH TECH USA



Standard Asymmetric Arm Configuration



Rotated Asymmetric Arm Configuration

TP11KC-DX
11,000lbs CAPACITY **2,799⁹⁹**

- 11,000 lb. lifting capacity
- Direct Drive Cylinders
- Overall Height: 145"
- Overall Width: 145-1/2"
- 3 Stage Front Arms, Low Profile Arms
- Asymmetric/Symmetric Arm Configuration
- Symmetric Columns
- Single Point Lock Release
- Rubber Door Guards
- Mounting Hardware included
- Spin Up Pads with 2" and 4" stackable drop in Truck Adapters
- Powder-Coated Finish



BI-SYMMETRIC™ DESIGN
Asymmetric/Symmetric arm configuration with 180 degree front arm rotation.

SERVICE LIFT

FP14K-C
14,000lbs CAPACITY Service Lift **4,999⁹⁹**

- 14,000 lb. lifting capacity
- Overall Height: 68-7/8"
- Overall Width: 136-3/4"
- Overall Length: 250-1/2"
- Cable Driven
- Closed Front
- Single point pneumatic safety release
- 20" wide non-skid, diamond plate runways
- Mounting Hardware included
- Powder-Coated Finish

Also sold as an Alignment Lift



BRIDGE JACK

RAJ-8K
8,000lbs CAPACITY **1,599⁹⁹**

- Universal Roller Body Design w/dual 'spring loaded' precision roller bearing and Side Guide Wheels w/adjustable Height for Low, Medium, and High Jack Rail Configurations
- Rolls on top edge of Jack Rail for smooth maneuverability
- Dual Height Telescoping Support Arms
- Pneumatic w/adjustable Pressure Regulator
- Stackable Pad and Height Adapters 1 5/16" and 5" (1 Pair each)
- Dual Air Bags



STORAGE LIFT

FP8K-DS
8,000lbs CAPACITY **2,599⁹⁹**

- 8,000 lb. capacity
- Overall Height: 86-1/4"
- Overall Weight: 103-1/2"
- Overall Length: 207-1/8"
- Ladder lock safety system with "auto engage" locking bar
- Extra-large slider blocks for added stability
- 10 Lock Positions
- Aircraft quality cables
- Single Point Lock Release
- 18" Wide non-skid, diamond plate runways
- Casters, Jack Tray, and Approach Ramps included

IDEAL



WHEEL SERVICE

TC-530
Semi-Automatic Tire Changer **1,599⁹⁹**

- Internal Clamping Capacity: 12" - 23"
- External Clamping Capacity: 10" - 20"
- Max Wheel Diameter: 38"
- Wheel Width: 3" - 12"
- Swing arm design
- Bead seating inflation jets are integrated in the clamping jaws
- Side mounted Bead Breaker



TC-950
Semi-Automatic Tire Changer **1,699⁹⁹**

TC-950-WPA
HighPerformance Tire Changer with PressArm **2,699⁹⁹**

- Internal Clamping Capacity: 15" - 28"
- External Clamping Capacity: 13" - 24"
- Max Wheel Diameter: 47"
- Wheel Width: 3" - 15"
- Swing arm design
- Bead seating inflation jets are integrated in the clamping jaws
- Twin clamping cylinders provide more power to hold the most difficult rims
- Conveniently located and powerful bead breaker
- Large diameter hex mount/demount shaft for extra rigidity
- Left side press arm (WPA)
- Ideal for low profile tires (WPA)
- No scratching, machine never contacts rim (WPA)



WB-953
HighPerformance Wheel Balancer **1,249⁹⁹**

- Max Wheel Diameter: 39"
- Rim Width: 1.5" - 20"
- Rim Diameter: 10" - 24"
- Wheel Weight Capacity: 150 lbs
- Self-calibrating; Self-diagnosis
- Optimization program
- Static balancing
- Three centering cones
- Hood, hammer, speed nut and caliper come standard
- Optional motorcycle adapter is available



WB-448
HeavyDutyTruck Wheel Balancer **2,499⁹⁹**

- Max Wheel Diameter: 47"
- Rim Width: 1.5" - 20"
- Rim Diameter: 10" - 24"
- Wheel Weight Capacity: 298 lbs
- Self-calibrating; Self-diagnosis
- Pneumatic Wheel lift included
- Foot brake for manual stop
- Capable of balancing a full range of wheels
- Car and Truck cones come standard



Leasing Terms Available!+

Ask Your AutoZone®
Commercial Sales Manager

AutoZone®
Tool & Equipment QUARTERLY

Dannmar®
EQUIPMENT

PORTABLE LIFT

MaxJax
SKU 186434
DAN1375659 **2,299⁹⁹**

- Lifting Capacity: 6,000 lbs
- Overall Height: 89"
- Fully Adjustable Lift Arms
- Easy Set-Up and Use



Price Does Not Include Vehicles, Installation or Optional Equipment as Shown.

BONUS

Rolling Work Seat
SKU 752040
Part# DAN106625

Value \$49.99



with Purchase of:
MaxJax 6,000 Lbs. Portable 2 Post Lift
SKU 186434
Part# DAN1375659

Offer Good Through September 30, 2016 While Supplies Last

2-POST LIFTS

D-2-9X
SKU 186430
DAN1375646 **2,649⁹⁹**

- Lift Capacity 9,000 lbs
- Floorplate Style
- Overall Height: 113"
- Rise: 74"



D-10 AC
SKU 186431
DAN1375648 **2,599⁹⁹**

- Lifting Capacity: 10,000 lbs
- Overall Height: 145"
- Rise: 69"
- Overall Width: 130-1/2"
- ASYMMETRIC WIDE



D-10 ACX
SKU 186433
DAN1375647 **2,649⁹⁹**

- Overall Width: 143-1/2"
- ASYMMETRIC WIDE

D-10 CX
SKU 186432
DAN1375649 **2,649⁹⁹**

- Overall Width: 145"
- SYMMETRIC WIDE

ALIGNMENT LIFT

D-12A COMBO
SKU 079778
DAN1381815 **6,499⁹⁹**

- Lifting Capacity: 12,000 lbs
- Overall Width: 130"
- Overall Length: 248"
- Max Rise: 66"
- Turn Plates Included



DRJ-6 (Qty 2)
SKU 343411
DAN1375901 **1,199⁹⁹**



AIRLINE KIT
SKU 752035
DAN17057064 **219⁹⁹**

Dannmar EQUIPMENT

SCISSOR LIFT

Cadet-6000XL
SKU 555446
DAN1375652 **1,749⁹⁹**

- Lifting Capacity: 6,000 Lbs.
- Max Rise with 6" Adapter: 49.375"
- Max Rise with 3" Adapter: 46.5"
- Shipping Weight: 792



Price Does Not Include Vehicles, Installation or Optional Equipment as Shown.

4-POST LIFTS

D-12A
SKU 343410
DAN1375681 **3,799⁹⁹**

- Lifting Capacity: 12,000 lbs
- Overall Width: 130"
- Overall Length: 248"
- Max Rise: 66"



Price Does Not Include Vehicles, Installation or Optional Equipment as Shown.

D-7
SKU 186464
DAN1375643 **2,599⁹⁹**

- Lifting Capacity: 7,000 lbs
- Visible Locking System
- Overall Length: 203-1/2"



D-7X
SKU 186427
DAN1375644 **2,699⁹⁹**

- Extended version of D-7
- Overall Length: 227-1/2"

Price Does Not Include Vehicles, Installation or Optional Equipment as Shown.

BONUS



Set of 3 Drip Trays
SKU 186439
Part# DAN101011
Value: \$69.99
with Purchase of:
Commander™ 7,000 Lbs. 4 Post Lift

Offer Good Through September 30, 2016 While Supplies Last

LIFT OPTIONS

FRAME CRADLE PAD
SKU 289999
DAN119527 **49⁹⁹**

- For 2-Post Lifts
- Sturdy Steel Construction
- Tactile Rubber Mat
- Product Description



LIFT PAD ASSY ROUND
SKU 079518
DAN17107036 **49⁹⁹**

- Works with Dannmar 2-Post Lift
- Thick Rubber Construction
- Easy Drop-In Design
- 5" Diameter



RND SLIP OVER PAD
SKU 752032
DAN17108252 **19⁹⁹**

- Resistant to Gouging
- Abrasion Resistant
- Tear Resistant
- Sold Individually



TURNPLATES
SKU 751634
DAN135501 **359⁹⁹**

- 14" x 13.5" x 2"
- Smooth Bearings
- Sturdy Construction
- Sold Individually



AIR-ELEC WORK STATION
SKU 751635
DAN1980999 **239⁹⁹**

- Works with Any Lift
- 4 110v GFI Outlets
- Oiler, Air Supply, PSI Gauge, Storage Hooks for Hose and Tools, Air Inlet



DRIP TRAYS
SKU 186439
DAN101001 **69⁹⁹**

- Set of 3
- Lightweight Pans
- Intended for Oil & Water-Based Fluids
- Product Description



SHOP EQUIPMENT

8-GAL OIL DRAIN
SKU 186458
DAN122829 **99⁹⁹**

- 8-Gal Capacity
- Adjustable Height: 48-67"
- Wide Drain Pipe for Draining Oil Quickly
- Large Funnel mouth to Catch Oil & Reduce Spillage



20-GAL OIL DRAIN
SKU 343408
DAN122835 **319⁹⁹**

- 20-Gal Capacity
- 15" Drainage Funnel
- Product Description
- Includes Regulator and Gauge



TRIPOD JACK STAND
SKU 186457
DAN105430 **124⁹⁹**

- 2 Ton Capacity
- Extra Tall & Stable
- Min Height : 68.7"
- Max Height: 76.7"



50' HOSE REEL
SKU 343407
DAN116911 **199⁹⁹**

- 50' of 3/8" of Rubber Hose
- Working Pressure: 250psi
- Max CFM: 25
- 4 Way Non-Snag Rollers



TIRE SERVICE

T-100 TIRE CHANGER
SKU 547117
DAN1381202 **1,599⁹⁹**

- Max Wheel Diameter: 50"
- Machine Weight: 507 lbs
- Rim Width: 3-15"
- Inside Clamp: 15-25"
- Outside Clamp: 12-22"



Price Does Not Include Tires or Rims as Shown.

Shown is OPTIONAL Power Assist Arm

B-100 WHEEL BALANCER
SKU 547121
DAN1381201 **1,449⁹⁹**

- Max Wheel Diameter: 44"
- Rim Width: 1.5-20"
- Rim Diameter: 1-28"
- RPM: 140



Price Does Not Include Tires or Rims as Shown.

ROLLING WORK SEAT
SKU 752040
DAN106625 **49⁹⁹**

- Capacity: 205 lbs
- Depth: 14-1/2"
- Overall Height: 14"



SAVE \$50

TRANSMISSION JACK
SKU 186451
DAN105452 **480⁹⁹** REG. \$530.99

- First Stage: 1,000 lbs
- Second Stage: 500 lbs
- Min 34" - Max 71"
- Heavy-Duty Steel Swivel Casters
- Rigorous Safety Overload System
- Controlled Pneumatic Descent for Safe Lowering

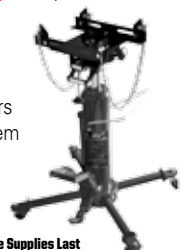

Offer Good Through September 30, 2016 While Supplies Last

ALIGNMENT LIFTS

Alignment Lifts

9,000 Lbs. 4 Post Alignment Lift

SKU 396661 **3,999⁹⁹**
BENHD-9AE

- Designed to Accommodate a Variety of Light-Duty Trucks and Automobiles
- Features Adjustable Multi-Position Leveling, Integrated Front Radius Plates and Rear Slip Plates



Optional:
RJ-45 Rolling Bridge Jack
SKU 898534 | BENRJ-45 **1,149⁹⁹**
Air Line Kit
SKU 531175 | BEN5174009 **254⁹⁹**



Price Does Not Include Vehicles, Installation or Optional Equipment as Shown.



1-877-AZTool1 (1-877-298-6651)

Leasing Terms Available.*
Ask Your AutoZone® Commercial Sales Manager.
Free Delivery!
in 48 Continental United States

14,000 Lbs. 4 Post Extended Alignment Lift

SKU 898468 **5,899⁹⁹**
BENHDS14LSXE

- Features Extended Runways to Accommodate a Wide Variety of Vehicle Wheelbases
- Integrated Industrial Strength Slip Plates and Turn Plates to Maximize Alignment Convenience



Optional:
RJ-7 Rolling Bridge Jack
SKU 212556 | BENRJ-7 **1,269⁹⁹**
Air Line Kit
SKU 531175 | BEN5174009 **254⁹⁹**



Price Does Not Include Vehicles, Installation or Optional Equipment as Shown.

14,000 Lbs. 4 Post Alignment Lift

SKU 898467 **5,499⁹⁹**
BENHDS14LSX

- Adjustable Leveling, Integrated Front Radius Plates and Rear Slip Plates Makes them Alignment Ready
- Compatible with All Leading Alignment Instrumentation, Including 3D and Camera Wheel Alignment Systems

Optional:
RJ-7 Rolling Bridge Jack
SKU 212556 | BENRJ-7 **1,269⁹⁹**
Air Line Kit
SKU 531175 | BEN5174009 **254⁹⁹**



Price Does Not Include Vehicles, Installation or Optional Equipment as Shown.

18,000 Lbs. Heavy Duty 4 Post Alignment Lift

SKU OUTSIDE BUY/EPO **12,499⁹⁹**
BENHDS-18EA

- Multi Caster Slip Plates in the Back and Turn Plates in the Front Allow for Extremely Precise, Free Floating Alignment
- Overall Width 154" / 3912 mm
- Overall Length 297" / 7544 mm
- Height of Columns 93" / 2362 mm

Available via Outside Buy/EPO, Call (1-877-298-6651) for details.



Price Does Not Include Installation or Optional Equipment as Shown.

Quatra™ 12,000 Lbs. Scissors Wheel Alignment Lift

SKU 527781 **12,599⁹⁹**
BENXR12000A

- Features a More Compact Footprint to Better Utilize Smaller Service Bays
- Accommodates a Variety of Wheelbases from Short Compacts to Extended Length Pick-Up and Work Trucks
- Includes Recessed Front Radius Plates and Oversized Rear Slip Plates

Optional:
RJ-6 Rolling Bridge Jack
SKU 210381 | BENRJ-6 **1,249⁹⁹**
Air Line Kit
SKU 531175 | BEN5174009 **254⁹⁹**



Price Does Not Include Installation or Optional Equipment as Shown.

Prices Do Not Include Vehicle, Installation or Optional Equipment as Shown. Lead Times Can Vary On Alignment Equipment. Call 1-877-AZTool1 for Questions on Specifications, Availability and Lead Times.

15,000 Lbs. 4 Post Alignment Lift Package

SKU 527779 **17,099⁹⁹**
CHLAR4015EAX

- Package Includes:
- (2) 7,500 Lbs. Rolling Jacks,
 - Internal Air Line Kit
 - Stainless Steel Radius Gauges
 - Dual Rear Slip Plates
 - 20" Runway Width



Includes Two Rolling Jacks

Price Does Not Include Installation or Optional Equipment as Shown.

CALL TO ORDER
1-877-AZTool1
(1-877-298-6651)

18,000 Lbs. Heavy Duty Alignment 4 Post Package with 22" Wide Runways

SKU 547120 **20,299⁹⁹**
CHLAR44018AR

- Package Includes:
- (2) 9,000 Lbs. Rolling Jacks
 - Internal Air Line Kit
 - Stainless Steel Radius Gauges
 - Dual Rear Slip Plates
 - Heavy Duty Chain Drive and Sealed Roller Bearings



Includes Two Rolling Jacks

Price Does Not Include Installation or Optional Equipment as Shown.

14,000 Lbs. 4 Post Closed Front Wheel Alignment Lift

SKU 527782 **18,999⁹⁹**
ROTAR14-EL2

- Compatible with the New Technology Alignment Systems On the Market Today
- Includes: Air Filter/Regulator/Lubricator, Internal Air Line, (2) 7,000 Lbs. Capacity Rolling Jacks, Stainless Steel Radius Gauges and Rear Slip Plates

Includes Two Rolling Jacks



Price Does Not Include Installation or Optional Equipment as Shown.

D-12A 12,000 Lbs. Alignment Lift

SKU 579870 **4,799⁹⁹**
DAN1375682

- Compatible with All Leading Alignment Instrumentation, Including 3D and Camera Wheel Alignment Systems
- Multi Caster Slip Plates in the Rear Provides Precise Free Floating Movement
- Multiple Radius Plate Locations
- Radius Plates Included

Optional:
BK Rolling Jack
SKU 343411 | DAN1375901 **1,199⁹⁹**
Airline Kit Not Include



Price Does Not Include Vehicles, Installation or Optional Equipment as Shown.

NEW

CALL TO ORDER
1-877-AZTool1
(1-877-298-6651)

14,000 Pound 4 Post Alignment Lift

SKU 568433 **10,499⁹⁹**
FORCRA14

- Max Wheelbase: 182-1/2"
- Four Wheel Alignment: 89 -1/4" to 156 -3/4"
- Durable Cable and Sheave System
- Includes: (2) 7,000 Lbs. Capacity Rolling Jacks, Carbon Steel Front Radius Plates

Includes Two Rolling Jacks



Price Does Not Include Vehicles, Installation or Optional Equipment as Shown.

18,000 Lbs. 4 Post Alignment Lift

SKU 568428 **17,999⁹⁹**
FORCRA18

- Max. Wheelbase: 194"
- Four Wheel Alignment: 63" to 162"
- Includes (2) Rolling Jacks, (2) Radius Plates and Internal Air Line Kit

Includes Two Rolling Jacks

Prices Do Not Include Vehicle, Installation or Optional Equipment as Shown. Lead Times Can Vary On Alignment Equipment. Call 1-877-AZTool1 for Questions on Specifications, Availability and Lead Times.

12,000 Lbs. Scissor Alignment Lift

SKU 527787 **16,999⁹⁹**
HOFEELR709A

- Overall Width: 90"
- Overall Length: 267-3/8"
- Width Between Runways: 40"
- Four Wheel Alignment Wheelbase: 89" to 158"
- Two Wheel Alignment Wheelbase: Up to 165"
- Service Wheelbase: 179"
- Runway Surface Width: 23"
- Maximum Raised Height: 70" (178 cm)
- Includes (2) Rolling Jacks

Includes Two Rolling Jacks

Price Does Not Include Installation or Optional Equipment as Shown.



*Turn Plates Not Included

Includes Air Line Kit and Two 6,000 Lbs. Rolling Jacks

Premium Turn Plates (Set of Two)
SKU 467503 **1,149⁹⁹**
HOFEAK0289J06

- Dimensions: 18.5" (L) x 19.7" (W) x 2" (H)

Prices Do Not Include Vehicle, Installation or Optional Equipment as Shown. Lead Times Can Vary On Alignment Equipment. Call 1-877-AZTool1 for Questions on Specifications, Availability and Lead Times.

14,000 Lbs. 4 Post Open Front Alignment Lift

SKU 527785 **17,999⁹⁹**
HOFEELR705A

- Industry Leading 90° Long Rear Slip Plates to Accommodate Shorter and Longer Vehicles
- Includes: Filter/Regulator, Air Line Kit, (2) 7,000 Lbs. Rolling Jacks

Leasing Terms Available.*
Ask Your AutoZone® Commercial Sales Manager.
Free Delivery!
in 48 Continental United States

CALL TO ORDER
1-877-AZTool1 (1-877-298-6651)

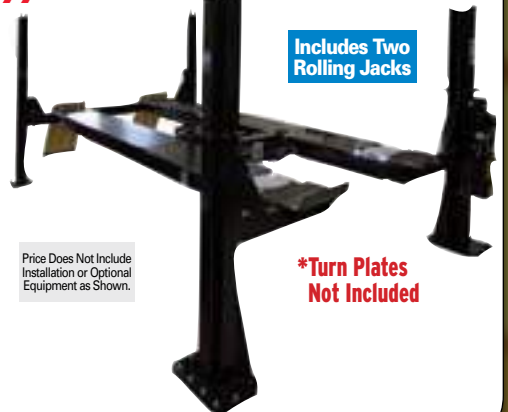

Includes Two Rolling Jacks

Price Does Not Include Installation or Optional Equipment as Shown.

*Turn Plates Not Included

Free Delivery!
in 48 Continental United States

Specifications Subject to Change Without Notice or Liability.
Prices Do Not Include Vehicles, Installation or Optional Equipment as Shown.

Customers Responsible for Offloading Equipment Upon Arrival.
Ask Your Sales Rep for Details.

Leasing Terms Available.*
Ask Your AutoZone® Commercial Sales Manager.

Leasing Terms Available!†

Ask Your AutoZone®
Commercial Sales Manager

AutoZone®
Tool & Equipment QUARTERLY

Alignment Systems

geoliner™ 500
Imaging Alignment System
SKU 514009
HOFEWA717ANB **11,449⁹⁹**

- Compact Design Saves Shop Space
- Completely Portable from Bay-to-Bay
- Easy-to-Use Alignment Software
- EZ-Link* Steering Angle Sensor Reset
- Animated Adjustments Benefit Technicians
- OEM Software for Steering Angle Reset
- Lithium-Ion Rechargeable Power Packs

Set Up and Training Included!



CALL TO ORDER
1-877-AZTool1 (1-877-298-6651)

FACTORY REBATES AVAILABLE
For More Info Visit
www.hofmann-usa.com

Lift Gate Service
SKU 290017
HOFLIFTGATE **95⁰⁰**

650 Imaging Aligner System with Multi-Level Camera Boom

SKU 527784
HOFEWA712AL **17,999⁹⁹**

- Set-Up to Readings in Under 2 Minutes
- High-Definition Imaging Cameras Allow for System Installation within a Smaller Shop Bay
- Patented VODI Graphic Display
- EZ-Link* Steering Angle Sensor Reset
- 2 Wheel Alignment Capability
- 24" Universal Wheel Clamps



CALL TO ORDER
1-877-AZTool1 (1-877-298-6651)

FACTORY REBATES AVAILABLE
For More Info Visit
www.hofmann-usa.com

Lift Gate Service
SKU 290017
HOFLIFTGATE **95⁰⁰**

geoliner™ 670 XD Wheel Aligner with Multi-Level Camera Boom

SKU 543347
HOFEWA715H **25,999⁹⁹**

One of the Most Advanced Alignment Systems On the Market Today

- Patented Imaging Technology Provides Accurate and Real-Time Measurements
- Smallest and Lightest Targets We've Ever Made
- Cross-Diagonal Measurements Identify Frame or Structural Damage
- AC400 Clamps with XD Targets
- Measures Right Height and Obtain Proper Alignment Specifications
- Step-by-Step Instructions as a Guide for Completing Even the Most Complex Tasks
- Extensive OEM Specifications Allow Quick and Accurate Vehicle Selection



CALL TO ORDER
1-877-AZTool1 (1-877-298-6651)



FACTORY REBATES AVAILABLE
For More Info Visit
www.hofmann-usa.com

Lift Gate Service
SKU 290017
HOFLIFTGATE **95⁰⁰**

geoliner® 770 Diagnostic Wheel Alignment System with AC400 Wheel Clamps and XD Targets

SKU OUTSIDE BUY/EPO
HOFEWA752B **25,999⁹⁹**

- Ideal For High-Volume Shops That Specialize In Alignments
- Compact Footprint, Designed To Fit Where You Need It
- Wireless Communication: Navigate, Monitor And Control the Unit From Anywhere In the Shop
- Includes: Steering Wheel Holder, (2) Wheel Chocks, Brake Pedal Depressor 24" Flat Panel Monitor, Color Inkjet Printer, AC400 Wheel Clamps with XD Targets
- Wireless Cameras
- AC400 Touchless Wheel Clamps

NEW



CALL TO ORDER
1-877-AZTool1 (1-877-298-6651)

FACTORY REBATES AVAILABLE
For More Info Visit
www.hofmann-usa.com

Lift Gate Service
SKU 290017
HOFLIFTGATE **95⁰⁰**

Available via Outside Buy/EPO,
Call (1-877-298-6651) for details.

Alignment Accessories



The Perfect Choice for Those Smaller Shops Who Want the Advantages of a 4 Post Lift But Have Limited Floor Space
QSP Wheel Stands Can Be Leveled and Used for Wheel Alignment, Transforming Your 2 Post Lift into a 4 Post Alignment Lift

24" Alignment Wheel Stands with Turn Plates and Slip Plates (Set of 4)

SKU 463769
QSPDB-24MD **2,199⁹⁹**

- Turn Plates and Slip Plates Built Right into the Stands
- Four Adjustable Legs to Level the Four Stands Together
- 2,500 Lbs. Capacity



We Offer a Full Line of QSP USA-Made Products.
Call 1-877-AZTool1 for Price, Specifications and Availability.



Add a Rear Slip Plate and Your Choice of Turn Plates to Convert Your Regular 4 Post 12,000/25,000 Lift into an Alignment Lift

Rear Slip Plate Add-On Kit

SKU 463777
QSPDB-6000 **2,299⁹⁹**

- (2) 59-1/2" x 20" Full Floating Rear Slip Plates
- Simple Installation On Most General Service Lifts
- Length Options: 205" to 200", 196" to 186" and 173"
- Turn Plates Not Included



Steel Turn Plates with Handle (Pair)

SKU 463771
QSP25-140 **549⁹⁹**

- Capacity: 4,500 Lbs. per Plate
- Features Dynamic Load Control
- Dimensions: 14" x 14" x 1.5"



Alignment Turn Plate (Pair)

SKU 751634
DAN135501 **359⁹⁹**

- Each Turn Plate Is Equipped with Roller Bearings for 'Full-Floating' Movement to Assure Easy Front - Wheel Positioning for Accurate Caster and Steering
- Sold in Sets of 2
- Dimensions: 14" x 13.5" x 2"



Stainless Steel Turn Plates without Pointer (Pair)

SKU 463808
QSP25-129 **949⁹⁹**

- Capacity: 4,500 Lbs. per Plate
- Dimensions: 14" x 14" x 1.5"
- Fits Most Standard Alignment Racks



Steering Wheel Holder and Pedal Depressor Kit

SKU 802195
24231 **64⁹⁹**

- Holds Steering Wheel in Position for Alignment Adjustments
- Depresses Brake Pedal for Various Brake Checks Including Brake Lamp Operation
- Simply Hand Squeeze the Actuator to Accomplish Fine Adjustments



ALIGNMENT LIFTS

SAVE OVER \$1,000

geoliner™ 500 Aligner Combo with 9,000 Lbs. Lift

SKU OUTSIDE BUY/EPO **16,499⁹⁹**
ALIGNCOMB01

- This Combo Package Puts You in the Alignment Business with High Quality Hofmann® and BendPak Products at a Great Low Price. The HD-9AE Four Post Alignment Lift Provides 9,000 Lbs. of Lifting Capacity to Accommodate a Variety of Light-Duty Trucks and Automobiles, and the Hofmann® geoliner® 500 Features the Next Generation of Imaging Alignment Technology
- This Kit Includes 2 RJ-45 Rolling Jacks and an Airline Kit
- Hofmann® Aligner Includes Set-Up and Training

ALIGNER COMBO1		\$16,499.99
BENHD-9AE	9,000 Lbs. Capacity Alignment Lift	\$3,999.99
HOFEWA717ANB	500 Aligner System	\$10,999.99
BENRJ-45	4,500 Lbs. Rolling Bridge Jack	\$1,149.99
BENRJ-45	4,500 Lbs. Rolling Bridge Jack	\$1,149.99
BEN5174009	Airline Kit HD-9 HD-14	\$254.99
TOTALS		\$17,554.95
SAVINGS		\$1,054.96

Available via Outside Buy/EPO,
Call (1-877-298-6651) for details.

Lift Gate Service
SKU 290017
HOFLIFTGATE **9500**



SAVE OVER \$890

geoliner™ 550 Aligner Combo with 14,000 Lbs. Lift

SKU OUTSIDE BUY/EPO **19,999⁹⁹**
ALIGNCOMB02

- We've Combined the geoliner® 550 Wireless Aligner with BendPak's HDS-14LSX Lift to Bring You Both Quality and Performance. The Hofmann® geoliner® 550 Features an Easy-to-Use Interface That Guides the Technician Through the Alignment Process and Completes a Fast and Efficient, Rolling Compensation without Jacking the Vehicle. The HDS-14LSX Pulls Double Duty As Both a Legendary 14,000 Lbs. Capacity Lift and an Alignment System.
- Combo Includes: Aligner, Lift, 2 Rolling Jacks and Airline Kit
- Hofmann® Aligner Includes Set-Up and Training

ALIGNER COMBO2		\$19,999.99
BENHDS14LSX	14,000 Alignment Lift	\$5,499.99
HOFEWA717B	550 Aligner System	\$12,599.99
BENRJ-7	7,000 Lbs. Rolling Jack	\$1,269.99
BENRJ-7	7,000 Lbs. Rolling Jack	\$1,269.99
BEN5174009	Airline Kit HD-9 HD-14	\$254.99
TOTALS		\$20,894.95
SAVINGS		\$894.96

Available via Outside Buy/EPO,
Call (1-877-298-6651) for details.

Lift Gate Service
SKU 290017
HOFLIFTGATE **9500**



SAVE OVER \$1,600

geoliner™ 650 Aligner Combo with 14,000 Lbs. Extended Length Lift

SKU OUTSIDE BUY/EPO **24,999⁹⁹**
ALIGNCOMB03

- The Latest Imaging Technology from Hofmann® geoliner® 650 Combined with BendPak's Legendary HDS14LSXE Makes for a Package That Delivers Beyond Your Expectations in Performance at a Price Much Less Than Expected. The geoliner® 650 Features Set-Up to Readings in Under 2 Minutes
- Combo Includes: Aligner, Extended Lift, 2 Rolling Jacks and Airline Kit
- Hofmann® Aligner Includes Set-Up and Training

ALIGNER COMBO3		\$24,999.99
BENHDS14LSXE	14,000 Alignment Lift Extended	\$5,899.99
HOFEWA712AL	650 Aligner System	\$17,999.99
BENRJ-7	7,000 Lbs. Rolling Jack	\$1,269.99
BENRJ-7	7,000 Lbs. Rolling Jack	\$1,269.99
BEN5174009	Airline Kit HD-9 HD-14	\$254.99
TOTALS		\$26,694.95
SAVINGS		\$1,694.96

Available via Outside Buy/EPO,
Call (1-877-298-6651) for details.

Lift Gate Service
SKU 290017
HOFLIFTGATE **9500**



SAVE OVER \$3,300

geoliner™ 670 XD Aligner Combo with 12,000 Lbs. Scissor Alignment Lift

SKU OUTSIDE BUY/EPO **36,999⁹⁹**
ALIGNCOMB04

- The geoliner® 670 XD Imaging Wheel Alignment System Is One of the Most Advanced Alignment Systems on the Market Today. Combine This with the Revolutionary Quatra Pantograph Lift from Bendpak and You Have the Ultimate Alignment Combo.
- Combo Includes: Aligner, Lift, 2 Rolling Jacks and Airline Kit
- Hofmann® Aligner Includes Set-up and Training

ALIGNER COMBO4		\$36,999.99
BENXR12000A	Quatra™ 12,000 Lbs. Capacity, Scissors Wheel Alignment Lift	\$12,599.99
HOFEWA715H	Geoliner 670XD	\$24,999.99
BENRJ-6	6,000 Lbs. Rolling Bridge Jack	\$1,249.99
BENRJ-6	6,000 Lbs. Rolling Bridge Jack	\$1,249.99
BEN5174009	Airline Kit HD-9 HD-14	\$254.99
TOTALS		\$40,354.95
SAVINGS		\$3,354.96

Available via Outside Buy/EPO,
Call (1-877-298-6651) for details.

Lift Gate Service
SKU 290017
HOFLIFTGATE **9500**



SAVE OVER \$2,000

Hofmann® Alignment Package Combo 650 Aligner with 12,000 Lbs. Scissor Lift

SKU 818791 **33,999⁹⁹**
HOFCOMB01

- Purchasing a Hofmann® Aligner and Alignment Lift Combo Will Not Only Save You Money, It Will Provide the Assurance of Having Components That Are Designed to Work Together. A Hofmann® Rep Will Train You and Your Employees in the Safest Most Profitable Way to Use Your New Equipment. Hofmann Aligners Provide the Most Advanced Alignment Systems On the Market. the Matching 12,000 Scissor Lift Maintains Constant Level Throughout the Lifting Range and Takes Up Less Space Than a Four Post.
- Includes: HOFEWA712AL 650 Imaging System Pro32 Aligner with AC200 Clamps HOFEELR709A 12,000 Lbs. Scissor Lift with 2-6,000 Lbs. Rolling Jacks, Airline Kit, Turn Plates and Roll Back Kit

HOFCOMB01		\$33,999.99
HOFEELR709A	Hofmann 12,000 Lbs. Scissor Alignment Lift	\$16,999.99
HOFEWA712AL	Hofmann geoliner™ 650 Imaging Wheel Aligner	\$17,999.99
HOFEAK0289J06	Premium Turn Plates (Set of Two)	\$1,059.99
TOTALS		\$36,059.97
SAVINGS		\$2,059.98

BONUS Value:
\$69.99

Roll Back Kit HOFEAK0277J28A
with Purchase of: HOFCOMB01 SKU 818791 | Part# HOFCOMB1



SAVE OVER \$2,400

geoliner™ 670XD Aligner Combo w/ 14,000 Lbs. Lift

SKU OUTSIDE BUY/EPO **36,999⁹⁹**
ALIGNCOMB05

- Combining the 670XD Imaging Wheel Alignment System along with the Forward CRA14 14,000 Lbs. 4 Post Alignment Lift gets you both the latest technology and proven durability. The geoliner™ 670XD Aligner provides patented imaging technology along with accurate and real-time measurements while the Forward CRA14 14,000 Lb Alignment Lift with concealed cable and pulley system and multi-position lock works as both an alignment and general service lift.
- Includes: Aligner, Steering Wheel Holder, Ride Height Target Kit, Brake Pedal Depressor, Remote Control, Color Inkjet Printer and Two Wheel Chocks, Alignment Lift, FLR (filter, lubricator, regulator), Two (2) 7,000 lbs. Capacity Rolling Jacks, Carbon Steel Front Radius Plates
- Hofmann Aligner includes Setup and Training

ALIGNCOMB05		\$34,999.99
FORCRA14	Forward Lift 14,000 Lb. 4 Post Alignment Lift	\$11,449.99
HOFEWA715H	Geoliner 670XD	\$24,999.99
FORRRJ70G	7,000 Lbs. Rolling Jacks (Set of Two)	INCLUDED
	Airline Kit	INCLUDED
TOTALS		\$37,449.98
SAVINGS		\$2,449.99

Available via Outside Buy/EPO,
Call (1-877-298-6651) for details.



Leasing Terms Available!†

Ask Your AutoZone®
Commercial Sales Manager

AutoZone®
Tool & Equipment QUARTERLY

GET THE BEST ELECTRICAL TESTER IN THE WORLD FOR **FREE***

*After purchasing your Auto Meter tester, you will automatically begin earning \$5 towards the total purchase price for every Duralast ProPower battery and Duralast & Duralast Gold starter and alternator— up to \$2,000 total.

AUTO METER'S PROFESSIONAL BVA HAND HELD TESTERS FASTEST, EASIEST, AND MOST ACCURATE TESTING TECHNOLOGY AVAILABLE!

- PATENTED DIGITAL PULSE LOAD™ (DPL) TESTING TECHNOLOGY DELIVERS A TRUE LOAD TO ACCURATELY SIMULATE REAL WORLD CONDITIONS.
- ACCURATELY TESTS THE BATTERY, STARTING AND CHARGING SYSTEM IN 82 SECONDS.
- TESTS NEARLY ALL BATTERY TYPES (AGM, DEEP CYCLE, AND STANDARD STARTING) INCLUDING DISCHARGED BATTERIES DOWN TO 11.8V.
- DURABLE ALL METAL HOUSING AND HEAVY DUTY LEADS/CLAMPS ENGINEERED FOR HIGH DEMAND AND FREQUENT USE ENVIRONMENTS.
- EASY TO USE, MENU DRIVEN INTERFACE ALLOWS EVEN INEXPERIENCED TECHS TO USE THE TESTER ACCURATELY.
- INCLUDES INFRARED PRINTER.



BVA-200DLP \$999.99
(AZ SKU # 974190)

BVA-200 ADDITIONAL FEATURES:

THE WORKHORSE OF THE AUTO METER LINE; ALL THE FUNCTION AND ACCURACY OF THE MORE ADVANCED TESTERS IN A BUDGET FRIENDLY PACKAGE.

TOUGH METAL CASE WITH RUBBER EASY GRIP BOOT FOR EXCEPTIONAL DURABILITY IN HARSH SHOP ENVIRONMENTS.



BVA-230DLP \$1199.99
(AZ SKU # 348188)

BVA-230 ADDITIONAL FEATURES:

EQUIPPED WITH EASY CARRY HANDLE, CLAMP RESTS, AND HEAVY DUTY CABLES TO MINIMIZE CLAMP WEAR AND TEAR.

MINI USB PORT FOR EASY PUSH/PULL OF DATA, TEST RESULTS, AND OR SOFTWARE UPGRADES.



BVA-260DLP \$1599.99
(AZ SKU # 348189)

BVA-260 ADDITIONAL FEATURES:

BUILT IN INFRARED BATTERY TEMPERATURE SENSOR TO IMPROVE TESTING ACCURACY.

PATENTED SMART CLAMP DESIGN TO ENABLE EASY CONNECTION TO GM SIDE POST BATTERIES.

SMART USB PORT FOR EASIER MORE EFFICIENT DATA RETRIEVAL AND SOFTWARE UPGRADES.



BVA-300PR \$899.99
(AZ SKU # 543332)

- THE SIMPLE SOLUTION FOR LOWER VOLUME BATTERY AND ELECTRICAL SYSTEM TESTING.
- INCLUDES ATTACHED PR-20 PRINTER.
- COMPLETE AND ENTIRE VEHICLE ANALYSIS IN UNDER 2 MINUTES
- PATENTED DPL TESTING TECHNOLOGY



PROFESSIONAL GRADE PARASITIC DRAW INDICATOR & MEMORY SAVER

SPS-12 \$159.99
(AZ SKU # 847121)

- EASY TO READ LED INDICATORS SHOW LOW, MEDIUM, OR HIGH CURRENT DRAW AIDING IN MAINTENANCE DIAGNOSIS.
- SOLID GREEN OR YELLOW LIGHTS INDICATE THAT CURRENT IS IN THE NORMAL RANGE.
- SOLID RED LIGHT INDICATES THAT CURRENT IS IN THE HIGH RANGE.
- AN UNLIT "POWER TO VEHICLE" LED INDICATES THAT CURRENT DRAW IS VERY HIGH.
- A FLASHING "AC POWER" LED INDICATES THAT THERE IS A DIRECT SHORT.

ADDITIONAL FEATURES
THE SMART POWER SYSTEM ALSO ACCURATELY MEASURES PARASITIC CURRENT DRAW. THIS IS CURRENT THAT IS DRAWN FROM THE VEHICLE'S BATTERY WHEN THE VEHICLE IS OFF WITH THE KEYS REMOVED. IT IS TYPICALLY LOW (20-80MA) AND IS USUALLY DUE TO THE ON BOARD COMPUTER.

Auto Meter
TEST EQUIPMENT

†Must be in good credit standing at the time of rebate payout. Shops must purchase a qualifying Auto Meter tester to start earning \$5 with every purchase of a Duralast ProPower Battery, Duralast and Duralast Gold Starter and Alternator. Qualifying brands of batteries, starters and alternators include Duralast®, Duralast Gold®, Duralast Platinum®, Duralast ProPower®, Duralast ProPower Plus®, Duralast ProPower Ultra®, Duralast ProPower AGM® or Duralast Professional®. Customer has one year to earn rebates from date of purchase of Auto Meter tester or maximum amount of \$2,000, whichever occurs first, paid quarterly to active customer account. John Cathy - Auto Meter Sales Rep - 815.762.4297

©2016 AutoZone, Inc. All rights reserved. AutoZone, AutoZone and Design, Loan A Tool, Duralast, Duralast Gold and Duralast ProPower are registered marks of AutoZone Inc. LLC or one of its affiliates.

JACKS AND HYDRAULICS

Floor Jacks and Stands

2 Ton Floor Jack

SKU 964622
HEIHW93642 **404⁹⁹**

- Min. Height: 4-1/2"
- Max. Height: 20-1/4"



3 Ton Floor Jack

SKU 964623
HEIHW93652 **534⁹⁹**

- Min. Height: 5"
- Max. Height: 23-1/2"



4 Ton Floor Jack

SKU 964624
HEIHW93657 **1,629⁹⁹**

- Min. Height: 5"
- Max. Height: 25-3/4"



22 Ton Air Hydraulic Truck Jack

SKU 544796
24851 **399⁹⁹**

- Compact, Low Profile Design Easily and Safely Fits Between Wheels of Tandem Axle Vehicles
- Min. Height: 8-7/8"
- Max. Height: 17-3/4"
- Ram Travel: 4-3/4"
- Screw Adjustment: 4-1/8"



3 Ton Ratcheting Jack Stand Set

SKU 964601
HEIHW93503 **94⁹⁹**

- Max. Height: 19"
- Ratchet Action Height Adjustment



6 Ton Ratcheting Jack Stand Set

SKU 964621
HEIHW93506 **134⁹⁹**

- Max. Height: 25-3/8"
- Ratchet Action Height Adjustment



The Banner 3-1/2 Ton Fast Lift Service Jack

SKU 344792
BHKB6350 **199⁹⁹**

- Min. Height: 5-1/2"
- Max. Height: 22"



3 Ton Jack Stand Set

SKU 222493
BHKBH5030 **44⁹⁹**

- Max. Height: 17"

1,500 Lbs. High Reach Jack Stand

SKU 300796
BHKBH5710 **119⁹⁹**

- Min. Lift Height: 53-3/8"
- Max. Lift Height: 78-7/8"
- Base: 12" Diameter



3/4 Ton High Reach Jack Stand with Foot Pedal

SKU 300797
BHKBH5715 **124⁹⁹**

3 Ton "Magic Lift" Jack with 3 Ton Stands

SKU 544584
OMG25033 **189⁹⁹**

- Jack Maximum Height: 20-7/8"
- Jack Minimum Height: 5-1/4"
- Jack Stands Maximum Height: 17"
- Jack Stands Minimum Height: 11-1/2"



3-1/2 Ton "Magic Lift" Service Jack

SKU 964644
OMG27035 **249⁹⁹**

- Innovative Design of Magic Lift Offers a Quick Lift
- Max. Height: 23"
- Low Profile Design Allows for Easy Access to Lift Points



6 Ton Magic Lift Jack Stand Set

SKU 964648
OMG32066 **79⁹⁹**

- Max. Height: 24-1/4"

20 Ton Air Hydraulic Bottle Jack

SKU 544795
24850 **129⁹⁹**

- Can Be Operated with Air or Manually
- Height: 10.25" - 20"
- Extension Screw Adjusts 3.25"



20 Ton Air Actuated Bottle Jack

SKU 012650
OMG18204C **294⁹⁹**

- Minimum Height: 9-3/4"
- Max Height: 18-3/4"
- Hydraulic Lifting: 5-1/8"
- Extension Screw: 3-7/8"



1-1/2 Ton Aluminum/Steel Hybrid Jack

SKU 847097
OMG26017 **219⁹⁹**

- Combines Aluminum and Steel for a Lightweight, Strong Jack Frame
- Extra Wide Wheels for Increased Stability
- Dual Piston Speedy Lift Lightweight Service Jack
- Minimum Height: 3.35", Maximum Height: 13.78"
- Gross Weight: 32.88 Lbs.



2-1/2 Ton Aluminum/Steel Hybrid Jack

SKU 847099
OMG26028 **269⁹⁹**

- Combines Aluminum and Steel for a Lightweight, Strong Jack Frame
- Extra Wide Wheels for Increased Stability
- Single Piston Magic Lift Lightweight Service Jack
- Minimum Height: 3.86" / Maximum Height: 18.62"
- Gross Weight: 57.27 Lbs.



3 Ton Aluminum/Steel Hybrid Jack

SKU 847104
OMG26033 **329⁹⁹**

- Combines Aluminum and Steel for a Lightweight, Strong Jack Frame
- Extra Wide Wheels for Increased Stability
- Single Piston Magic Lift Lightweight Service Jack
- Minimum Height: 3.74" / Maximum Height: 19.09"
- Gross Weight: 70.48 Lbs.



2 Ton Low Profile Service Jack

SKU 847093
OMG29021 **219⁹⁹**

- Dual Fast Action Pump Piston
- U-Joint Assembly for Precise Load Control
- Minimum Height: 3.13" Maximum Height: 19.88"
- Gross Weight: 70 Lbs.



3 Ton Low Profile Service Jack

SKU 847096
OMG29033 **299⁹⁹**

- Dual Fast Action Pump Piston
- U-Joint Assembly for Precise Load Control
- Minimum Height: 4" Maximum Height: 21"
- Gross Weight: 83.7 Lbs.



Tripod Jack Stands

2 Ton High Tripod Jack Stands

SKU 901744
RANRJS2TH **119⁹⁹**

- Perfect for Holding Drive Train or Exhaust Components in Position
- Capacity: 4000 Lbs.
- Low Height: 55"
- Max Height: 87"



2 Ton Tripod Auxiliary Stand

SKU 818750
OMG33020 **149⁹⁹**

- Heavy Gauge, Steel Frame Helps Prevent Distortion or Twisting
- Adjustable Height: 53-3/4" - 78-7/8"
- Base: 24" x 24" x 24"



Wheel Dolly

3/4 Ton Wheel Dolly

SKU 291389
OMG47053 **559⁹⁹**

- Safely Remove and Install Wheel Assemblies from HD Trucks
- Single, Duals/Tandems and Duplex Tires and Wheels
- Lift Arms Can Be Adjusted to Handle Different Wheel Combinations



Jack Accessory

Garage Floor Jack Crossbeam

SKU 544803
24833 **59⁹⁹**

- Compatible with Any Floor Jack that Has a 1-1/8" Diameter Saddle Stud
- Saddles Adjust from 23" to 32" On Center
- Weight Capacity at Min. - Max. Width: 3,000 Lbs. - 4,000 Lbs.



Leasing Terms Available!†

Ask Your AutoZone®
Commercial Sales Manager

AutoZone®
Tool & Equipment QUARTERLY

Transmission Jacks

1,100 Lbs. Telescopic Transmission Jack

SKU 544786 24840 **179⁹⁹**

- Lift Range: 51" - 70"
- Adjustable Saddle with Tilt in Both Directions
- Durable Steel Casters
- Safety Tie-Down Chain to Secure the Load



70" REACH

1,100 Lbs. High Lift Transmission Jack with Foot Pump

SKU 750006 24844 **349⁹⁹**

- Lift Range: 47" - 77"
- Adjustable Saddle with Tilt
- Spring-Loaded Release Valve Controls Lowering
- Durable Steel Casters



77" REACH

1/2 Ton Capacity Transmission Jack

SKU 902481 RANRTJ1100 **379⁹⁹**

- Lifting Capacity: 1,100 Lbs.
- Lowered Height: 45"
- Raised Height: 72"



72" REACH

SAVE \$100

1 Ton, 2 Stage Transmission Jack

SKU 544788 24842 **499⁹⁹** REG. \$599.99

- Lift Range: 33.5" - 72.5"
- 3 Way Adjustable Saddle Slides and Tilts Both Directions
- Convenient Foot Pedal Pump and Release
- Safety Anchor
- Chain Included



72-1/2" REACH

Offer Good Through September 30, 2016 - While Supplies Last

700 Lbs. Transmission Jack

SKU 533215 BHKBH7000 **389⁹⁹**

- Lifting Capacity: 700 Lbs.
- Lowered Height: 57-1/4"
- Raised Height: 76-5/8"
- Double Pivoting Adjustable Saddle that Can Expand to Almost 19" x 19"

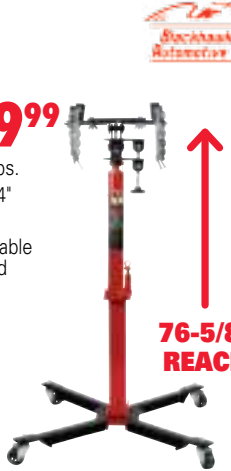

76-5/8" REACH

1 Ton Telescoping "Transjak"

SKU 902478 RANRTJ1 **689⁹⁹**

- Capacity First Stage: 2,000 Lbs.
- Capacity Second Stage: 1,000 Lbs.
- Lowered Height: 37"
- Raised Height: 79-1/2"



79-1/2" REACH

1-1/2 Ton Telescoping Transmission Jack

SKU 902484 RANRTJ3000 **749⁹⁹**

- Capacity First Stage: 3,000 Lbs.
- Capacity Second Stage: 2,000 Lbs.
- Lowered Height: 37"
- Raised Height: 79-1/2"



79-1/2" REACH

SAVE \$50

ManSpace 2 Stage Transmission Jack

SKU 186451 DAN105452 **480⁹⁹** REG. \$530.99

- First Stage: 1,000 Lbs., Second Stage: 500 Lbs.
- Min: 34" - Max: 71"
- Safety Overload System
- Heavy-Duty Steel Swivel Casters
- Hands-Free Foot Pedal



Offer Good Through September 30, 2016 - While Supplies Last

1/2 Ton Air Actuated Telescopic Transmission Jack

SKU 222744 OMG41001C **1079⁹⁹**

- Air Turbo Motor Is Air Equipped to Raise the Load to the Desired Height Efficiently, Effortlessly and Safely
- Chrome-Plated Rams Maximize Its High Reach Operated By a User-Friendly Foot Pedal
- Max. Height: 78-1/8"

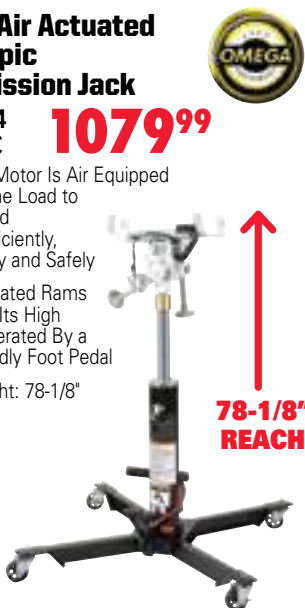

78-1/8" REACH

1/2 Ton Telescoping Transmission Jack

SKU 964652 OMG41000C **744⁹⁹**

- Lifting Capacity: 1,000 Lbs.
- Lowered Height: 37-7/8"
- Raised Height: 77-5/8"



77-5/8" REACH

800 Lbs. Low Profile Transmission Jack

SKU 544789 24843 **349⁹⁹**

- Lift Range: 8-1/4" to 30-1/2"
- Fully Adjustable Saddle Adapts to Most Transmission Pans
- Swivel Saddle Adjusts Both Directions
- (4) Swivel Ball Bearing Casters for Ease of Mobility



1 Ton Floor Style Transmission Jack

SKU 964631 HEIHW93718 **2,284⁹⁹**

- Max. Height: 44-3/4"
- Designed for Heavy Duty Transmissions

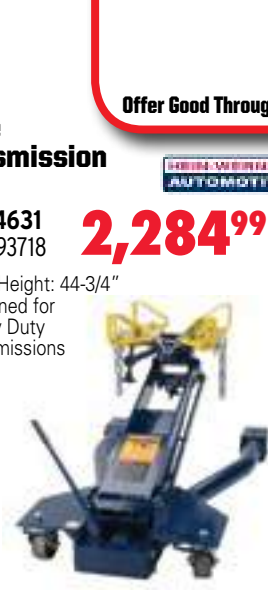

Fuel Tank Adapter for Transmission Jacks

SKU 222503 DOWJDI-FTA7 **189⁹⁹**

- Safe and Convenient Adapter for Handling Vehicle Fuel Tanks
- Works with Most Transmission Jacks



Body Repair



4 Ton Porto Power Kit

SKU 301327 24820 **149⁹⁹**

- Long Handle Provides Low Pumping Effort
- Comes in a Blow Mold Case



4 Ton Body Repair Kit

SKU 964654 OMG50040 **174⁹⁹**

- Quick Connect Technology for Effortless Assembly



4 Ton Porto Power Kit

SKU 964658 PPBB65114 **199⁹⁹**



10 Ton Porto Power Kit

SKU 301328 24821 **259⁹⁹**

- Features a Faster (Double-Action) Hydraulic Pump Causing the Ram to Move with Both the Up and Down Strikes of the Arm
- Comes in a Blow Mold Case



10 Ton Body Repair Kit

SKU 964656 OMG50100 **274⁹⁹**

- Quick Connect Technology for Effortless Assembly of Attachments to Meet Your Pushing and Pulling Needs
- Includes: Hand Pump, Hydraulic Hose, 10 Ton Ram, 18", 10", 4-1/8" and 28" Extension Tubes, Male Connector, Wedge Head, Serrated Saddle, Flat Base, Ram Toe, Plunger Toe, Rubber Head, 90° Combination Head, Spreader, Dust Cover (for Hose), Dust Cover (for Ram), Hose Coupler, Ram Coupler and Blow Mold Case

10 Ton Porto Power Kit

SKU 964663 PPBB65115 **354⁹⁹**

- Snap-Lock Design for Quick and Easy Assembly
- Automatic Pump Overload System Protects Against Damage to Rams and Equipment
- 1/2 Ton Capacity Hydraulic Spreader Features 2" Jaws and Spreads from 5/8" to 3-3/4"
- Custom Fitted, Rugged Blow Molded Storage Case with Wheels for Easy Movement Between Jobs



Accessories

5 Ton Flat Body Kit

SKU 964667 PPBB65139 **154⁹⁹**

- Ideal for Applications in Limited Spaces
- (4) Adapters for Added Height
- Chrome Plated Plunger



10,000 PSI Air Actuated Foot Pump

SKU 964639 OMG22903 **294⁹⁹**

- Provides Up to 10,000 PSI with Standard Shop Air Supply of 110 - 175 PSI
- Oil Capacity: 50 Oz.

JACKS AND HYDRAULICS

BONUS Shop Press Pin Set

SKU 544794 | PART# 24813
Value: \$99.99

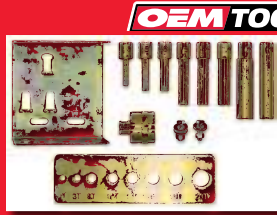

- Includes Set of (8) Press Pins, 2 to 20 Ton Capacity, with 25 mm Ram Adapter
- Suitable for Use with Hydraulic Ram Style Shop Presses Which Have a Female Ram Assembly Diameter of 25 mm and Are Secured with a Bolt
- Includes Mountable Bracket
- Works with OEMTOOLS 24811 and 24812
- Not for Use with Bottle Jack Style Shop Presses

OEM TOOLS

with Purchase of:
12 Ton Hydraulic Shop Press w/ Gauge
SKU 544790 | Part# 24811
or
20 Ton Air/Hydraulic Shop Press w/ Gauge
SKU 544793 | Part# 24812

12 Ton Hydraulic Shop Press with Gauge

SKU 544790
24811
349⁹⁹

- Includes Press Blocks
- Oil Filled Pressure Gauge Provides Accurate Pressure Readings
- Measurement Between Uprights: 20"
- Working Range: 0" to 36-1/8"



20 Ton Air/Hydraulic Shop Press with Gauge

SKU 544793
24812
499⁹⁹

- Includes Press Blocks
- Oil Filled Pressure Gauge Provides Accurate Pressure Readings
- Ram Moves Side to Side for Versatility
- Measurement Between Uprights: 21-1/8"
- Working Range: 0" to 40-1/2"



Offer Good Through September 30, 2016 - While Supplies Last

SAVE \$50

OEM TOOLS

20 Ton Shop Press

SKU 300134
24810
329⁹⁹ REG. \$379.99

- Remove and Install Bearings, Gears, U-Joints, Bushings, Ball Joints and Pulleys
- Multi-Position Bed for Work Height Adjustment
- Max. Height: 31.5"
- Max. Width: 21.75"
- Includes Press Plates



Offer Good Through September 30, 2016 While Supplies Last

Super Heavy Duty H-Frame Press Weighs Over 250 Lbs. Providing More Strength And Durability Compared to Similar Lighter Weight Shop Presses On the Market

SAVE \$100

OEM TOOLS

Vehicle Position Jacks with Storage Cradle

SKU 696485
68986
449⁹⁹ REG. \$549.99

- Includes (4) Position Jacks with Storage Stand
- Move Up to a 6,000 Lbs. Vehicle with Ease Adjusts 3.25"



Offer Good Through September 30, 2016 - While Supplies Last

SAVE \$30

OEM TOOLS

1,500 Lbs. Vehicle Position Jack (Each)

SKU 544798
24855
99⁹⁹ REG. \$129.99

- Hydraulic Ram Provides Stable Foot Pedal Lift in Seconds
- Rolls in Any Direction



Offer Good Through September 30, 2016 - While Supplies Last

Bearing Separators

5 Ton Bar-Type Puller/Bearing Separator Set

SKU 347218
27236
99⁹⁹

- Separator Tools Are Used with Bar Puller and Legs for a Wide Variety of Pulling Jobs
- Set Includes: 2" and 3" Bearing Splitters, (4) Sets of Hex Push-Puller Legs and a Bar-Type Puller Head with a 9/16" Forcing Screw



Bearing Splitter, 1/2" to 4-5/8"

SKU 514006
27232
59⁹⁹

- Razor Sharp Edges Wedge Between Parts and Securely Holds Tool
- Maximum Spread: 4-5/8"
- Minimum Spread: 1/2"
- Thread of Tapped Holes in Adapter: 5/8" - 18
- Distance Between Adjusting Screws: 4-3/8"



Bearing Splitter, 1/4" to 15/16"

SKU 514005
27231
29⁹⁹

- Maximum Spread: 15/16"
- Minimum Spread: 1/4"
- Thread of Tapped Holes in Adapter: 5/16" - 18
- Distance Between Adjusting Screws: 1-11/16"



Wheel Dollies

OEM TOOLS

Vehicle Position Jack Storage Stand

SKU 544800
24856
59⁹⁹

- Neatly Secure and Store Up to (4) Vehicle Car Dolly Jacks
- Dimensions: 24-7/8" (L) x 31-7/8" (W) x 9-9/16" (H)
- 5" x 1" 360 Degree Swivel Ball Bearing Wheels for Easy Maneuvering
- Weight Capacity: 300 Lbs.



Engine Lifts

Duralast

2 Ton Capacity Engine Hoist

SKU 123037
80-900T
229⁹⁹

- 8 Ton Capacity Hydraulic Jack for Faster and Easier Raising Action
- Large Diameter Ram to Withstand Side Loads
- 4 Position Telescoping Boom Is Adjustable from 1/2 Ton to 2 Ton Capacity
- Legs Are Over 55" Long for Greater Stability



2 Ton Folding Shop Crane

SKU 544801
24830
399⁹⁹

- Foldable Design Makes for Convenient, Easy Storage
- (6) Solid Steel Caster Wheels Add Mobility
- Fully Adjustable 4 Position Boom



2 Ton Folding Engine Crane

SKU 902288
RANRSC2TF
499⁹⁹

- Heavy Duty Hydraulic Folding Engine Hoist with 8 Ton Capacity Ram Is Perfect for Shops that Have Limited Space but Still Need the Pure Lifting Convenience of a Crane
- Front Casters Include a Safety Brake to Prevent Movement



Engine Supports

THEXTON

GM Engine Moving Tool

SKU 511006
THX419X
59⁹⁹

- Fits GM Front Wheel Drive Vehicles with Engine Torque Struts
- Safely Holds Engine in Place
- Extra Bolt Holes Provide Fit On All Vehicles
- Includes Adapter 419A



3 Point Engine Support Bar

SKU 133617
24951
79⁹⁹

- Makes Removal of Transaxle Easy By Supporting Engine of Front Wheel Drive Vehicles
- 700 Lbs. Capacity
- (2) 14" Adjustable Hook Screws
- Width Expands from 34-1/2" to a Full 61"
- (2) 38" Braided Steel Cables



1,100 Lbs. Engine Support

SKU 512946
24950
119⁹⁹

- (2) Screw Adjusters for Precise Positioning - Makes Job Easier, Faster and Safer
- Rubber Feet to Prevent Damage to Vehicle and Ensure Stability
- 1,100 Lbs. Capacity



LOWER PRICE

2 HOOKS - 2 CHAINS
Twice the Adjustment Means Faster, Easier AND Safer

Engine Stands

OEM TOOLS

1,250 Lbs. Engine Stand

SKU 462493
24829
129⁹⁹

- Easy-to-Move and Rotate
- Heavy Gauge Square Steel Tube Frame
- Extra Wide 4 Wheel Base Provides Added Stability
- 360° Rotation
- Lock Pin Locks Engine into Position
- Includes Tool Tray



1,250 Lbs. Engine Stand

SKU 534418
OMG31250
179⁹⁹

- Constructed from Heavy Gauge Welded Square Tubular Steel
- Extra Long Handle with Rubber Grips for Easy Rotation and Maneuvering



1 Ton Folding Engine Stand

SKU 544804
24834
249⁹⁹

- Folds Upright to Conserve Valuable Floor Space
- Sturdy, Wide Base Design to Prevent Tipping Under Load
- Slotted Adjustable Saddle Permits Quick and Easy Installation
- Head Swivels 360° to Easily Position Engine



1,250 Lbs. Rotating Engine Stand

SKU 964646
OMG31256
339⁹⁹

- Extra Long Handle with Rubber Grip for Easy Rotation and Maneuvering
- Head Plate Locks in 8 Positions and Rotates 360°
- Heavy Duty Worm Gear Allows for Smooth and Effortless Engine Rotation



Leasing Terms Available!†

Ask Your AutoZone®
Commercial Sales Manager

AutoZone®
Tool & Equipment QUARTERLY



Torin®'s newest brand "TCE" brings the professional market the same pride, dependability and service automotive professionals have trusted for the last 50 years.



All TCE products carry a two (2) year limited warranty.

Hoist Stands

1,500 lbs. High Position Jack Stand

SKU 451493
TCE40753
99⁹⁹

- Max Height 79-7/8"
- Featuring Heavy-Duty Steel and High-Strength Welds for Safety in Mind
- ACME All Thread Rod Adjustment for Varied Load Heights



2 Ton Tri-Fold High Position Jack Stand

SKU 451494
TCE42009
109⁹⁹

- Max Height 83-3/4"

Transmission Jacks

1000 lbs Telescoping Transmission Jack

SKU 451475
TCE50055
749⁹⁹

Double Ram for a Lower Profile
Saddle Forward Tilt 30 Degree
Saddle Reverse Tilt 12 Degree
Lifting Range: 35" to 70-1/2"



1 TON Transmission Jack

SKU 451476
TCE10001
629⁹⁹

- Single Person Operation
- Heavy-Duty Jack for Transmission Installation and Removal
- Universal Mounting Head Provides a Wide Fore and Aft Tilt Range



Saddle Forward Tilt 68 Degree
Saddle Reverse Tilt 15 Degree
Rated Capacity: 2000 Lbs.
Lifting Range: 8-1/4" to 30-5/8"

Jack Stands

7 Ton Square Tube Vehicle Support Stand

SKU 451490
TCE47000
119⁹⁹

Adjustment Range: 9-5/8" to 15-3/8"

(Sold in Pairs)



10 Ton Support Stand

SKU 451491
TCE41000
164⁹⁹ each

Adjustment Range: 28-3/8" to 46-7/8"



Vehicle Support Stand

(Sold in Pairs)

4 Ton
Adjustment Range: 12-3/16" to 18-7/8"
SKU 451488
TCE44008
79⁹⁹

7 Ton
Adjustment Range: 16-5/16" to 25-3/16"
SKU 451489
TCE47008
119⁹⁹



Auto Body Repair Kit

4 Ton Auto Body Repair Ram System

Min. Ram Stroke 10-3/4" Max. Ram Stroke 15-5/8"

SKU 451492
TCE70401
159⁹⁹



Bottle Jacks



12-Ton Stubby
Lifting range: 6-5/8" to 9-15/16"

SKU 451483
TCE91208
84⁹⁹

20-Ton Stubby
Lifting range: 7-1/8" to 10-1/2"

SKU 451487
TCE92008
119⁹⁹



12-Ton Manual
Lifting range: 9" to 18-1/8"

SKU 451480
TCE91207
84⁹⁹

20-Ton Manual
Lifting range: 10-7/8" to 18-3/8"

SKU 451486
TCE92007
119⁹⁹



12-Ton Air/Hyd
Lifting range: 10-7/16" to 20"

SKU 451478
TCE31000
199⁹⁹

20-Ton Air/Hyd
Lifting range: 10-7/16" to 20"

SKU 451479
TCE31001
229⁹⁹

Lift Equipment

4,000 lbs (2 Ton) Ultra-Low Profile Garage Jack

- Lifting Range: 3" to 20"
- Ultra-Low Profile Design Gives Clearance to Even High Performance Super Cars
- Heavy-Duty Tubular Grip Handle That Provides Easy Handling
- Patented Quad-Trak Designed Polyurethane Front Wheels That Get Over Any Bump or Crack with No Resistance
- Polyurethane Mounted Rear Swivel Caster Wheels
- Rubber Saddle Pad and Foam Bumper Pad
- Built-In Wheel Nut Tray

SKU 451477
TCE82002
359⁹⁹



6,500 lbs (3-1/4 Ton) Professional Garage Jack

- Lifting Range: 3-13/16" to 21-1/8"
- Designed for the Shop Guys with Work in Mind and Security Guaranteed
- Dual Pump Pistons for Faster Rising Action
- Thick U-Channel Frame Side Plates and Reinforced Lifting Arm
- Tubular Grip Handle That Provides Easy Handling
- Rubber Saddle Pad and Foam Bumper Pad

SKU 451485
TCE83508
199⁹⁹



Shop Presses

20 Ton Shop Press

SKU 451481
TCE20021
899⁹⁹

Force: 40,000 lbs
Bed Internal Dimension: 21-5/8"
Working Range: 0" to 39-3/8"
Stroke: 7-1/2"

30 Ton Shop Press

SKU 451472
TCE30021
1099⁹⁹

Force: 60,000 lbs
Bed Internal Dimension: 21-5/8"
Working Range: 2" to 44-1/2"
Stroke: 5-7/8"

50 Ton Shop Press

SKU 451473
TCE50021
1899⁹⁹

Force: 100,000 lbs
Bed Internal Dimension: 27-15/16"
Working Range: 2-5/8" to 36-1/4"
Stroke: 7-1/2"

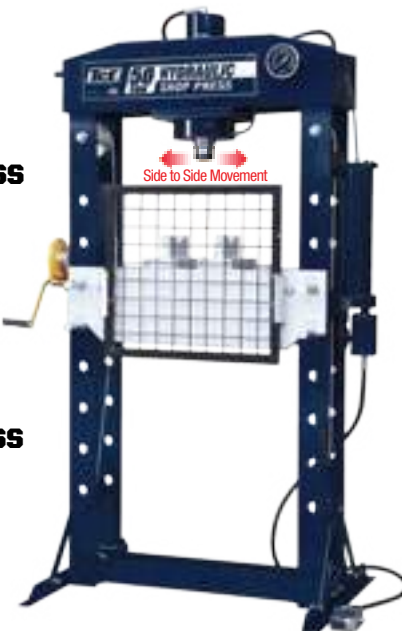

- Heavy-Duty H-Frame Steel Construction
- Side-to-Side Cylinder Ram Adjustment Combines Speed & Precision
- Adjustable Platform
- Safety Guard
- Dial Gauge

The hydraulic cylinder assembly is moveable and equipped with a locking device on all models. Great for hard to maneuver parts.



- Heavy-duty H-frame. Air pneumatic pump with trigger push-button control
- Bends, presses and straightens
- Gauge dial
- Double spring ram return

40 Ton Shop Press

Force: 80,000 lbs
Bed Internal Dimension: 27.12"
Working Range: 0" to 35.04"
Stroke: 6.89"

SKU 335338
TRD54003
799⁹⁹

45 Ton Shop Press

Force: 90,000 lbs
Bed Internal Dimension: 25.38"
Working Range: 0" to 34.06"
Stroke: 6.89"

SKU 103248
TRD54501
899⁹⁹

50 Ton Shop Press

Force: 100,000 lbs
Bed Internal Dimension: 27-15/16"
Working Range: 2-5/8" to 36-1/4"
Stroke: 7-1/2"

SKU 341096
TRD55002
999⁹⁹



Rolling Tool Cart

- Ideal for both domestic and industrial use.
- Manufactured of heavy gauge steel.
- Work surface with slip resistant rubber mat.
- Four wheels for easy maneuvering.



SKU 988851
TC325C
199⁹⁹

Mobile Work Station

SKU 988853
TC327
289⁹⁹



JACKS AND HYDRAULICS

Quick Jacks



QUICKJACK™



The Ultimate Car Jack and Support System

- Sets up in seconds
- Easy to transport
- Simple to operate

The QuickJack Portable Lifting System Makes Vehicle Maintenance on the Track and Off Convenient and Lightning Fast. The QuickJack Can Go Anywhere and Can Be Easily Stowed in the Trunk or Back Seat of Most Cars When Not in Use. Bring It to the Track or Drop It on Your Garage Floor to Perform Routine Maintenance in the Comfort of Your Home, All in Seconds.

3,500 Lbs. QuickJack™ Car Jack Support System

SKU 850894
RANBL3500SLXA (110V AC) **1,129⁹⁹**

- Complete Package Includes; (2) Ea. Jack Frame Assemblies, (2) Ea. 150" Hydraulic Hoses, (2) Ea. 14" Aux. Hoses, (2) Ea. Quick-mount Handles, (4) Ea. 1.5" X 3" X 4" Rubber Lifting Blocks, (4) Ea. 3" X 3" X 4" Rubber Lifting Blocks, (1) Mini Hydraulic Power Unit with Pendant Control.

12V DC Option Available

Price Does Not Include Vehicles, Installation or Optional Equipment as Shown.



5,000 Lbs. QuickJack™ Car Jack Support System

SKU 850896
RANBL5000SLXA (110V AC) **1,349⁹⁹**

- Complete Package Includes; (2) Ea. Jack Frame Assemblies, (2) Ea. 150" Hydraulic Hoses, (2) Ea. 14" Aux. Hoses, (2) Ea. Quick-mount Handles, (4) Ea. 1.5" X 3" X 4" Rubber Lifting Blocks, (4) Ea. 3" X 3" X 4" Rubber Lifting Blocks, (1) Mini Hydraulic Power Unit with Pendant Control.

12V DC Option Available

Price Does Not Include Vehicles, Installation or Optional Equipment as Shown.

You get it all.

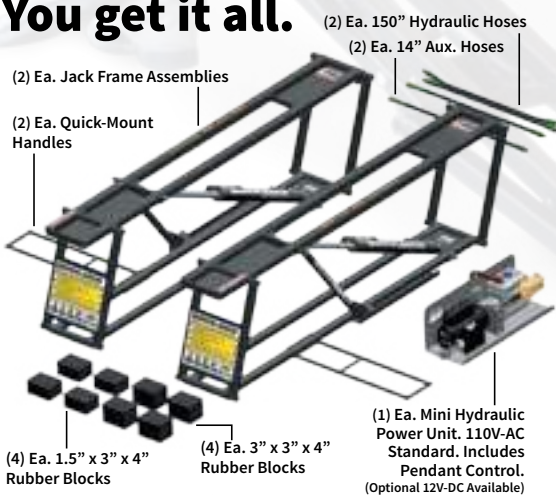

QuickJack™ SUV and Light Truck Adapters

SKU 862288
RAN5150561 **299⁹⁹**

- Set of 12 Pieces
- Fits BL-5000 and BL-7000 Series
- Complete Kit Includes: (4) Low-Profile Round Polyurethane Contact Pads (4) Sliding Receivers Accommodate the Round Polyurethane Contact Pads (4) 3" Stackable Adapters



FREE
SUV AND LIGHT
TRUCK ADAPTERS
with purchase of
BL-7000SLX

7,000 Lbs. QuickJack™ Car Jack Support System

SKU 850897
RANBL7000SLXA (110V AC) **1,599⁹⁹**

- Complete Package Includes; (2) Ea. Jack Frame Assemblies, (2) Ea. 150" Hydraulic Hoses, (2) Ea. 14" Aux. Hoses, (2) Ea. Quick-mount Handles, (4) Ea. 1.5" X 3" X 4" Rubber Lifting Blocks, (4) Ea. 3" X 3" X 4" Rubber Lifting Blocks, (1) Mini Hydraulic Power Unit with Pendant Control. Also Included: (1) SUV and Light Truck Adapter Set That Includes; (4) Low-profile Round Polyurethane Contact Pads, (4) 3" Stackable Adapters, (4) Sliding Receivers

12V DC Option Available

Price Does Not Include Vehicles, Installation or Optional Equipment as Shown.

SPECIFICATIONS:	BL-3500SLX	BL-5000SLX	BL-7000SLX
Weight Capacity / Pair	3,500 Lbs. / 1588 kg.	5,000 Lbs. / 2268 kg.	7,000 Lbs. / 3175 kg.
Individual Frame Weight:	60 Lbs. / 27 kg.	76 Lbs. / 34 kg.	91 Lbs. / 41 kg.
Platform Lifting Height (Frame Only)	16.5" / 419 mm.	17.2" / 437 mm.	17.7" / 450 mm.
Platform Lifting Height (W/Blocks)	20" / 508 mm.	22.5" / 572 mm.	21.2" / 538 mm.
Minimum Collapsed Height	3" / 76 mm.	3" / 76 mm.	3.5" / 89 mm.
Rubber Block Position Min	26.7" / 678 mm.	31.5" / 800 mm.	31.5" / 800 mm.
Rubber Block Position Max	50.5" / 1283 mm.	60" / 1524 mm.	60" / 1524 mm.
Frame Width	10.5" / 267 mm.	11" / 278 mm.	12.5" / 318 mm.
Frame Length	62" / 1575 mm.	72.5" / 1841 mm.	72.5" / 1841 mm.
Lifting Time	10 seconds	15-30 seconds	15-30 seconds

Leasing Terms Available!†

Ask Your AutoZone®
Commercial Sales Manager

AutoZone®
Tool & Equipment QUARTERLY

OMEGALIFT™ EQUIPMENT

Omega Service Jacks are Made for Working Professionals, They Offer the Features and Durability That Professionals Demand, But at a Price That Won't Break the Bank.

The Omega Hybrid Jack combines aluminum and steel resulting in a strong, lightweight jack frame with extra wide wheels for increased stability when fully loaded. Together with a dual piston high speed pump, side handles for ease of carrying and u-joint style control valve makes this the ideal jack to go from the shop to your truck to the racetrack.

No Other Lightweight Jack Incorporates All Of These Features.

3 Ton Aluminum Jack

SKU 847102 **369⁹⁹**
OMG26030

- All Aluminum Structure Provides Strength and Stability
- Side Frame Handles Allow for Easy Carrying
- U-Joint Assembly for Precise Load Control
- Minimum Height: 2.91" Maximum Height: 20.12"
- Gross Weight: 44lbs



OMEGALIFT™ EQUIPMENT

The Omega Low Profile Jack is designed with a fast action pump and u-joint assembly for precise lowering and load control. These new Low Profile Jacks from Omega are ideal for today's vehicles.

2½ Ton Low Profile Magic Lift Jack

SKU 847105 **189⁹⁹**
OMG29028

- Foam Handle Cover
- U-Joint Assembly for Precise Load Control
- Minimum Height: 3.35"
- Maximum Height: 19.3"
- Gross Weight: 69.5 Lbs



2 1/2 Ton Low Profile Service Jack

SKU 847094 **229⁹⁹**
OMG29027

- Dual Fast Pump Piston
- U-Joint Assembly for Precise Load Control
- Minimum Height: 2.9"
- Maximum Height: 20"
- Gross Weight: 71 Lbs



3 Ton Low Profile Magic Lift Jack

SKU 847106 **199⁹⁹**
OMG29031

- Foam Handle Cover
- U-Joint Assembly for Precise Load Control
- Minimum Height: 3.75"
- Maximum Height: 19.75"
- Gross Weight: 75.3 Lbs



3 1/2 Ton Low Profile Magic Lift Jack

SKU 847107 **219⁹⁹**
OMG29038

- Foam Handle Cover
- U-Joint Assembly for Precise Load Control
- Minimum Height: 4"
- Maximum Height: 21"
- Gross Weight: 83.7 Lbs



OIL CHANGE

Low Profile Oil Drains

17 Gallon Low Profile Truck Drain

SKU 526486
LIN3665 **379⁹⁹**

- 6' Hose Extends from the Bottom of the Reservoir and Can Be Connected to a Pump to Evacuate Fluid from the Drain



17 Gallon Low Profile Truck Drain with Hand Pump

SKU 526485
LIN3667 **499⁹⁹**

- Features a Rotary Hand Pump and a 6' Discharge Hose with a Steel J-Hook



17 Gallon Low Profile Truck Drain with Electric Pump

SKU 526487
LIN3669 **629⁹⁹**

- Features a Durable 120V Electric Pump Installed Below the Front of the Reservoir
- Pump Operates with a Standard Power Outlet and Discharges Fluid Through a 6' Hose with Steel J-Hook



Drain Plug Socket Set

14 Pc. Drain Plug Socket Set

SKU 818568
25374 **49⁹⁹**

- Designed for Both Foreign and Domestic Vehicles Including: BMW, Ford, Mazda, Mercedes-Benz, Nissan, Peugeot, Renault and More
- Ideal for Removal of Oil Drain Plugs from Manual Transmissions, Transfer Cases, Differential Housings and More
- Includes: (Hex) 9, 10, 12, 14 and 17 mm; (Square) 7, 8, 11, 13 mm, 5/16", 3/8"; (Female Square) 10 mm; (Male Triangle) 10 mm, (Tams-Proof Triple Square) 16 mm



SAVE \$15

Toyota/Lexus Oil Filter Cap Wrench Set

SKU 383457
25409 **24⁹⁹** REG. \$39.99

- Sizes: 64 mm, 73 mm and 74 mm
- Use in Conjunction with a 22 mm or 7/8" Socket or Wrench



Offer Good Through September 30, 2016 While Supplies Last

Oil Filter Wrenches

Professional 3 Legged Filter Wrench

SKU 231212
25413 **19⁹⁹**

- Range: 2-1/2" to 4-1/2"
- Fits 3/8" Drive Ratchet and Extensions



10 Piece Cap Filter Wrench Set

SKU 900828
27196 **42⁹⁹**

- (10) 3/8" Drive Cap Oil Filter Wrenches
- Includes: 65/67 mm - 14 Flutes, 80 mm - 15 Flutes, 68 mm - 14 Flutes, 86 mm - 16 Flutes, 74/76 mm - 15 Flutes, 93 mm - 15 Flutes, 76 mm - 14 Flutes, 93 mm - 36 Flutes, 76 mm - 30 Flutes, 100 mm - 15 Flutes



10 Inch Master Oil Filter Locking Pliers

SKU 850037
25323 **22⁹⁹**

- Capacity: 2-1/8" to 4-1/2" (55 to 120 mm)
- Length: 10" (200 mm)
- Provides Ability to Turn without Squeezing
- Removes Oil Filters in Hard-to-Reach Areas



9 Piece Oil Filter Cap Wrench Set

SKU 255627
27199 **119⁹⁹**

- (3) Forged Low Profile Sockets Wrenches Included: 27 mm, 32 mm and 36 mm Sizes
- (5) High Quality, Chrome Plated Aluminum Wrenches: 1 Adjustable, 63 mm to 83 mm Sizes and a Filter Wrench for Universal Applications
- All Wrenches Are Designed to Work with 3/8" Square Drive Tools
- Includes Application Chart

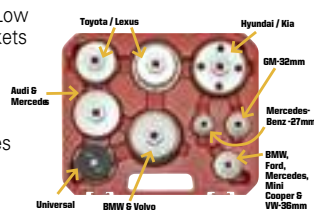

Oil Filter Sockets

7 Piece Oil Filter Removal Wrench Set

SKU 191682
27197 **49⁹⁹**

- 3/8" Drive
- Includes: 24 mm for Cadillac, 36 and 27 mm for Mercedes, VW, Cadillac, Buick Saturn, SAAB, 29 mm for Dodge Cummins Fuel Filter, 30 mm for Korean Cars, 32 mm for GM, Saturn and SAAB, 35/36 for Ford Diesel, Mini Cooper, BMW and Mack, 38 mm for Vauxhall/Vectra



3 Piece Low Profile Oil Filter Socket Set

SKU 094803
27204 **22⁹⁹**



- Includes 27, 32 and 36 mm
- 3/8" Drive
- Comes in a Blow Mold Case

32mm and 36mm Double Sided Oil Filter Socket

SKU 020797
25421 **19⁹⁹**

- 3/8" Drive
- Applications: [2011-2016] VW TDI, 2009-2016 Touareg and VR6 Motors; [2015-2016] Audi Q3 and S3 with 2.0 T Gas; [2007-2010] Q7 and [2014-2016] A6 3.0T; [2009-2011] BMW 335d, X5 35d and [1994-2005] BMW 6 And 8 Cylinder Engines; [2007-2014] Volvo Models; [2007-2014] Chevy Cobalt, Impala And Malibu With 2.2 And 2.4 Liter Engines; [2009-2016] Porsche Models



Oil Filter Cap Wrenches

SKU	Part #	Description	Size	Price
383456	25408	2006 BMW Series (E90) and All 1999 - 2005 Volvo Cars (Except 2005 40 and 50 Series)	86.5 mm, 16 Flutes	19.99
255634	25451	2005 Toyota on Cartridge Style or 2006 Lexus on Cartridge Style - Fits 4 and 6 Cylinder Engines	64.5 mm, 14 Flutes	19.99
255669	25452	BMW (M44 Engine), Mercedes (M102, M103 Engines), Porsche (924, 928), VW, Audi	74.2 mm, 14 Flutes	19.99
255675	25453	BMW (N52, N54, N55, N63 Engines - 2006 to 2012), Volvo (All Models exc 2005 40 and 50 Series)	64.5 mm, 14 Flutes	24.99
255659	25454	Hyundai, Kia	88.8 mm, 15 Flutes	19.99



Oil Drains

21 Gallon Oil Drain and Vacuum Evacuator

SKU 546658
24862 **499⁹⁹**

- Designed for Collection of Motor Oil, Transmission Fluid and Coolant from Under Lift-Mounted Vehicles or By Evacuation from Fluid Reservoirs or Through Dipstick Tubes
- Funnel Diameter: 15"
- Funnel Extension Adapter: 22"
- Funnel Height Adjustment: 45" - 62"



BONUS
Air Grease Gun
SKU 125116 | Part# 25818
VALUE: \$49.99

with Purchase of:
21 Gallon Oil Drain and Vacuum Evacuator
SKU 546658 | Part# 24862

with Purchase of:
21 Gallon Waste Oil Drain
SKU 544817 | Part# 24861

21 Gallon Waste Oil Drain

SKU 544817
24861 **449⁹⁹**

- Large Diameter Funnel that Includes a Removable Filter Screen and Wide-Mouth Extension
- Funnel Diameter: 15"
- Funnel Extension Diameter: 22"
- Funnel Height Adjustment: 45" - 62"



Accessories

Super Transmission Drain Funnel

SKU 291377
LIS17902 **49⁹⁹**

- Extends the Catch Area of Any Lift Drain
- Fits the Ford E 40D



Transmission Drain Funnel

SKU 291376
LIS17892 **24⁹⁹**

- Funnel Size: 22" x 23"



Replacement Funnel for OEM 8 and 18 Gallon Oil Drains

SKU 526493
25896-1 **34⁹⁹**



No Splatter Pads

- Insert Pad in Funnel or Pan Before Oil Change to Eliminate Oil Splatter
- Porous Material Allows Fluid to Quickly Pass Through into Funnel or Pan



18 Gallon Oil Drain with Pump

SKU 383453
25897 **149⁹⁹**

- Drain Adjusts from 48" - 71" Tall
- 2-1/2" Heavy Duty Casters
- 18" Diameter Funnel with Strainer



8 Gallon Oil Drain

SKU 383454
25896 **79⁹⁹**

- Drain Adjusts from 30" - 63" Tall
- 2-1/2" Heavy Duty Casters
- 18" Diameter Funnel with Strainer



18 Gallon Rolling Oil Drain

SKU 988882
LIN3601 **259⁹⁹**

- All Steel Design Includes Reinforced Caster Supports
- 14" Telescoping Bowl: Range of 45" - 72"
- Preset Air Regulator (Up to 150 PSI)
- Pressurized Self-Evacuation Feature Requires Only Shop Air and a Tire Chuck to Discharge Fluids



25 Gallon Used Fluid Combo Drain/Evacuator

SKU 543345
LIN3639 **579⁹⁹**

- Powerful Compressed Air Operated Venturi Vacuum Quickly Draws Fluids from Reservoirs
- Includes Mercedes, BMW and VW Dipstick Tube Adapters and (6) Evacuation Wands of Varying Flexibility, Diameter and Length
- Pressurized Self-Evacuation Feature Requires Only Shop Air and a Tire Chuck to Discharge Fluids



BONUS
Over \$9.00 in Savings When You Buy the Set!

Fluid Management

4.5 Gallon Drain Pan (Green)

SKU 255766
LIS17952 **26⁹⁹**

- Pan Is Resistant to Chemicals and Solvents
- 1" Wide Diameter Spout for Quick and Easy Pouring



Truck/Trailer Wheel Pan

SKU 291383
LIS19852 **19⁹⁹**

- Catches Oil from Wheel Hubs After Removing Cap
- Capacity of 88 Oz.
- Handle Compartments Hold Hub Nuts Out of the Oil



Right Angle Funnel

SKU 020782
LIS17232 **14⁹⁹**

- 10" Tall Translucent Funnel with a 6-3/4" Offset
- Funnel Mouth is 3.5" O.D. and the Spout is .7" O.D.



4 Piece Oil Drain and Funnel Set

SKU 754740
68985 **24⁹⁹** REG. \$34.96

- Oil and Transmission Funnel (#87008)
- 850 cc Square Oil Funnel (#87012)
- Drain Pan with Level Scale (#87013) 13.8" x 12.6" x 4.3"
- 2.8 Quart Low Profile Oil Drain Set (#87017)

Offer Good Through September 30, 2016 While Supplies Last



2.8 Quart Low Profile Oil Drain Pan

SKU 568474
87017 **14⁹⁹**

- Low Profile Oil Drain Pan
- Dimensions: 15.9"(L) x 8.5"(W) x 2.68"(D)
- Capacity: 2.8 Quarts



Drain Pan with Level Scale

SKU 568469
87013 **12⁹⁹**

- Great for Transmission Fluid Changes
- Built-In Level Scale Lets You See Fluid Levels
- Fits On Top of Standard Size 5 to 8 Gallon Drums



Drum Drain Basin for 5 Gallon Bucket

SKU 568471
87014 **26⁹⁹** *Bucket not included

- Fits On Top of Standard Size 5 to 8 Gallon Drums
- Ribbed Drainage Channels
- Filter Gate to Catch Foreign Objects
- Size: 13.8" Diameter
- Capacity: 3.2 Quarts

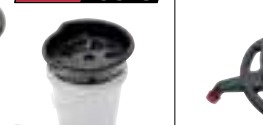

Oil Drain Basin with Pour Spout

SKU 568473
87016 **26⁹⁹**

- Pour Spout and 2 Handles to Allow for Easy Spill-Free Work
- Anti-Splash Lip
- Capacity: 4 Gallons
- 17.7" Diameter



Drum Drain Basin for 55 Gallon Drum

SKU 568472
87015 **49⁹⁹**

- Fits On Top of Standard Size 55 Gallon Drums
- Ribbed Drainage Channels
- Filter Gate to Catch Foreign Objects
- Size: 26" Diameter
- Capacity: 21 Quarts





Contact Us:
1-877-AZTool1 Phone
 (1-877-298-6651) *Hablamos Español*

Pumps

Lever-Action Pump (Polypropylene)

SKU 688036 **39⁹⁹**
24471

- Ideal for Diesel, Kerosene, Lubricants and Other Oils
- Not for Gasoline, Water-Based Chemicals or DEF



Lever-Action Pump (Polypropylene, Stainless Steel Rod)

SKU 688038 **44⁹⁹**
24472

- Ideal for Pumping Diesel, Oils, Kerosene, Water-Based Chemicals, Bases and Mild Acids
- Not for Gasoline or DEF



Lever-Action Pump (Ryton® Stainless Steel Rod)

SKU 688037 **64⁹⁹**
24473

- Ideal for Pumping Diesel, Oils, Kerosene, Water-Based Chemicals, Bases and Acids Including DEF
- Not for Gasoline



Rotary Drum Pump (Polypropylene)

SKU 688035 **99⁹⁹**
24470

- Ideal for Pumping Diesel, Oils, Kerosene, Water-Based Chemicals, Bases and Mild Acids
- Not for Gasoline or DEF



Multi-Use Fluid Transfer Pump

SKU 094647 **14⁹⁹**
25713

- Small and Lightweight
- Intake and Discharge Transfer System
- Pumps Air into Inflatables
- Includes: (2) 50" (127 cm) Long Hoses



Fluid Siphon Pump

SKU 568475 **17⁹⁹**
24863

- Transfers Fluids Easily
- Use to Transfer Gas, Water, Oil and Other Non-Corrosive Liquids
- Hose Reaches 6 Ft. with 1/2" Diameter



Multi-Purpose Drill-Powered Pump

SKU OUTSIDE BUY/EPO **9⁹⁹**
24503

- Works with a Corded or Cordless Drill to Transfer the Following Liquids: Fresh Water, Sea Water, Organic Solvents, Motor Oil, Heating Oil, Insecticides and Liquid Fertilizers



Available via Outside Buy/EPO. Call (1-877-298-6651) for details.

Hand Oil Pump

SKU 462495 **29⁹⁹**
24381

- Oil Pump for Use with Oil-Based Fluids, Heating Oils, Motor Oils, Heavy and Light Oils, Diesel and Kerosene
- Built-In 1-1/2" and 2" Bung for Use On 16 to 55 Gallon Drums with Either Opening
- Not for Gasoline



Rotary Barrel Pump

SKU 462486 **39⁹⁹**
24382

- Fluid Transfer Pump for Use with Oil-Based Fluids, Heating Oils, Motor Oils, ATF, Diesel and Kerosene
- Not for Gasoline



Lever-Action Barrel Pump

SKU 970530 **79⁹⁹**
LIN1340

- Pumps Non-Corrosive Fluids, Not for Gasoline
- Telescoping Tube for 16 to 55 Gallon Drums
- Removable Non-Drip Spout Allows for Threaded Hose Connection



Manual Gear Lube Dispenser

SKU 174166 **99⁹⁹**
LIN1293

- 5 Ft. Hose, 13" Pump Tube
- Fits 25 - 50 Lbs., 5 Gallon Container
- Delivers 1 Oz. per Stroke



Manual Rotary Pump with Hose for 55 Gallon Drums

SKU 265089 **229⁹⁹**
LIN1385H

- Includes: 8 Ft. x 3/4" Anti-Static Hose with Non-Sparking Aluminum Nozzle with Hanger, Seal Tight Telescoping Pick-Up Tube with Strainer for 16 - 55 Gallon Drums with 2" Bung and H.D.



Manual Rotary Pump for 55 Gallon Drums*

SKU 462977 **174⁹⁹**
LIN1385

* Hose and Drum Not Included

* Drum Not Included

BONUS
 5 Qt. Measuring Can
 SKU 298486 | Part# LING525
VALUE: \$44.99

with Purchase of:
Manual Rotary Pump with Hose
 SKU 265089 | Part# LIN1385H
 Offer Good Thru September 30, 2016
 While Supplies Last

Manual Rotary Fuel Pump with Hose for 55 Gallon Drums

SKU 265088 **269⁹⁹**
LIN1387

- 3 Vane Manual Rotary Pump for Most Fluid Types Including Gasoline, Diesel, Kerosene, Coolant, Non-Corrosive Materials, Medium Viscosity Petroleum Based Fluids, Hydraulic Oils and ATF



* Drum Not Included

Grease Pump Package

SKU 110259 **949⁹⁹**
LIN6917

- Portable 50:1, Air Operated, Double-Acting Grease Pump Ensures High-Output Grease Delivery
- Lube Fitting with Control Valve and Universal Swivel
- Standard Follower Wipes 120 Lbs. Drum Sides Clean and Keeps the Pump Primed



12V Fuel Transfer Pump

SKU 754742 **499⁹⁹**
LIN1550

- Delivers Fuel at a Rate of 15 Gal/Min. (57 L/Min.)
- 13' (4 m), Heavy Duty, Anti-Static Hose that Is Kink Resistant
- Pre-Wired with a Heavy Gauge 18 Ft. (5.4 m) Cable for Operator Convenience
- Applications: Diesel, Kerosene or Mineral Spirits from Both Mobile and Stationary Tanks



Grease Service

Professional Lever Action Grease Gun

SKU 094656 **29⁹⁹**
25893

- Lever Action Handle with Textured Rubber Non-Slip Grip
- Lightweight, Rust-Free Anodized Aluminum Barrel



Professional Pistol Grip Grease Gun

SKU 094654 **29⁹⁹**
25892

- 12" Heavy Duty Nylon Hose with Coupler
- 5.5" Extension with 1/8" NPT Male Threads
- Working Pressure: 4,500 PSI

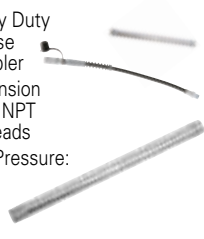

Air Grease Gun

SKU 125116 **49⁹⁹**
25818

- Great for Automotive, Workshop and Marine Use
- Operating Pressure: 30 - 150 PSI
- Delivery Pressure: 1,200 - 6,000 PSI
- Air Consumption: 4.0 CFM



Extra Heavy Duty Pistol Grip

SKU 445385 **59⁹⁹**
LIN1134

- 18" Whip Hose
- Includes Rigid Pipe
- Jam Proof Handle
- Variable Stroke Design
- 7,500 PSI
- Filler Nipple/Bleeder Valve



7 Piece Grease Fitting Adapter Kit

SKU 978118 **29⁹⁹**
25711

- Includes: Press-On 90° Lube Tool, Straight Extension, 300 mm Hose Extension, Slide-On 90° Coupler, Rubber Tip Nozzle, Needle Nozzle, 360° Coupler



Bearing Packer

SKU 900799 **29⁹⁹**
25073

- Works On Bearings Up to 3-1/2" O.D.
- Forces Old Grease Out and New In



Drain Plugs

SMART-O™ 38 Plug Starter Kit

SKU 404638 **134⁹⁹**
BRA38

- Kit Includes: 38 Plugs with Washers: 6 Each: F1; 5 Each: R1, R6; 4 Each: F3, R9; 3 Each: R3; 1 Each: R4, R5, R11, R16, R20, R21, R22, R23, R24, S13, S18
- Does Not Include POS Materials



Fluid Evacuators

Fluid Evacuator

SKU 594882 **104⁹⁹**
MITMV7400

- Integrated 1.9 Gallon (7.3 Liter) Capacity Reservoir
- Large Base with Foot Stabilizer



Fluid Evacuator (2.5 Gallon)

SKU 547010 **119⁹⁹**
24397

- 2.5 Gallon (9.5 Liters)
- Extracts All Types of Engine, Transmission and Lubricating Oils
- Extracts Fluids Through Dipstick Tubes As Well As Other Openings
- Float Assembly to Prevent Overflow



PneumatiVac Fluid Evacuator

SKU 497203 **139⁹⁹**
MITMV7300

- Operates On Compressed Air
- 2.3 Gallon (8.8 Liter) Capacity Reservoir
- Large Base with Foot Stabilizer
- Independent Air Shut-Off Valve



Brake Bleeder Adapter Hose for Fluid Evacuators

SKU 568479 **19⁹⁹**
24446

- Quickly Connects to OEM Models 24389 or 24397 Fluid Evacuators Converting Them into One-Person Vacuum Brake or Hydraulic Clutch Bleeders



BONUS

Brake Bleeder Adapter Hose
 SKU 568479 | Part# 24446

VALUE: \$19.99



with Purchase of:
Fluid Evacuator (1.4 Gallon)
 SKU 544744 | Part# 24389

Fluid Evacuator (1.4 Gallon)

SKU 544744 **79⁹⁹**
24389

- 1.4 Gallon (5.6 Quarts, 5.3 Liters) Reservoir with Hand Operated Pump
- 5 Ft. of Flex Hose and (2) Dipstick Hoses
- Use to Extract Most Fluid Types: Engine Oil, Transmission Fluid, Gear Oil, Coolant, Power Steering Fluid



Offer Good Through September 30, 2016 - While Supplies Last

Dispensers

5 Quart Translucent Oil Dispenser

SKU 544816 **18⁹⁹**
87011

- Translucent White Material Enables the User to See the Liquid Level
- Includes Flexible Spout



8 Quart Dispenser Lid and Cap

SKU 080078 **29⁹⁹**
LIS19702

- Spout Cap and Lid to Keep Out Contaminants
- Many Large SUVs and Trucks Now Require More Oil



Flexible Spout Measuring Cans

- Designed for One-Hand Operation
- 14" Flexible Spout with Tapered Tip
- Recessed Bottom Drains Fully and Guards Against Punctures
- Rolled-Edge Top Helps Prevent Spilling



5 Quart
 SKU 298486 **44⁹⁹**
 LING525

8 Quart
 SKU 298473 **49⁹⁹**
 LING528

Transmission Refill

Automatic Transmission Refill System

SKU 265092 **329⁹⁹**
MITMV6410

- Includes: Reservoir Lid with Integrated Manual Pump, Pressure Gauge, and Pressure Relief Valve, 5 Ft. Fluid Dispensing Hose, MVA5800 ATF Refill Adapter Kit, Fluid Dispensing Wand and Hanging Hook



SAVE \$50

ATF Refill and Universal Fluid Dispensing System

SKU 526508 **149⁹⁹**
24441 REG. \$199.99

- Complete System for Servicing Sealed Automatic Transmissions
- Includes Adapters to Fit Ford, BMW, Honda, Nissan, VW, Porsche, Mini Cooper, Audi and Mercedes Transmissions



Offer Good Through September 30, 2016 - While Supplies Last

COOLING SYSTEM

BONUS

VALUE: \$16.99

Professional Series Ethylene Glycol Antifreeze Tester

SKU 750007 | Part# 24507

with Purchase of:
No-Spill Coolant Filling Funnel Kit
SKU 802197 | Part# 87009

No-Spill Coolant Filling Funnel Kit

SKU 802197 87009 **29⁹⁹**

- 5 High Quality 1 Piece Adapters - No Assembly or Searching for Loose Parts
- Simply Select the Correct Adapter, Attach the Funnel and Fill
- Includes Extensions and Adapters for Hard-to-Reach Surge Tanks



OEM TOOLS

Offer Good Through September 30, 2016 While Supplies Last

BONUS

VALUE: \$37.98

Locking Hose Pinch-Off Pliers

SKU 626113 | Part# 24432

Locking Hose Pinch-Off Pliers

SKU 626110 | Part# 24431

with Purchase of:
Cooling System AirEvac Kit
SKU 099292 | Part# 27066

Cooling System AirEvac Kit

SKU 099292 27066 **99⁹⁹**

- Uses Shop Air to Evacuate the Cooling System for Vacuum Leak Testing
- Refills Cooling System without Trapping Air that Causes Overheating
- Universal Adapter Forms an Airtight Seal with Radiator and Coolant Bottle Necks
- Self-Locking Quick Disconnects for Fast Assembly



OEM TOOLS

Offer Good Through September 30, 2016 While Supplies Last

Cooling System

Airvac Coolant Refiller

SKU 568478 24444 **99⁹⁹**

- Quickly Refills Cooling System and Eliminates Trapped Air
- Helps Prevent Come-Backs and the Threat of Engine Damage
- Performs Vacuum Leak Tests
- Covers Most Radiator and Reservoir Types



OEM TOOLS

Locking Hose Pinch-Off Pliers

- Features Locking Ratchet Mechanism to Hold Jaws Tightly in Place
- Eliminates the Need to Drain the Radiator When Servicing Cooling System

SKU 626113 24432 **17⁹⁹**

- Clamp Brake Lines, Fuel Lines, Coolant Hoses and Vacuum Lines Up to 1"



OEM TOOLS

SKU 626110 24431 **19⁹⁹**

- Clamp Cooling System Hoses Up to 1-1/4" (30 mm) in Diameter



Hose Clamp Pliers

SKU 607069 25246 **36⁹⁹**

- Removes Plastic and Metal Self-Tightening Hose Clamps with Diameters of 11/16" to 2-1/2"



OEM TOOLS

2 Piece Hose Clamp Pliers

SKU 972767 25198 **24⁹⁹**

- Services Most Ring-Type or Flat-Band Hose Clamps
- Jaws Swivel to Access Hose Clamps in Any Position



OEM TOOLS

5 Piece Hose Clamp Plier Set

SKU 965836 27159 **39⁹⁹**

- Services Most Ring-Type or Flat-Band Hose Clamps
- Jaws Swivel to Access Hose Clamps in Any Position



OEM TOOLS

Water Pump Holding Tool for GM

SKU 094808 27207 **34⁹⁹**

- Use for 2002 - 2008 GM 2.2L and 2.4L Eco Tech Engine in Chevrolet, Oldsmobile, Pontiac and Saturn Platforms



OEM TOOLS

2.4 Gallon Plastic Radiator Filler

SKU 754738 87104 **26⁹⁹**

- Impervious to Oil, Gasoline and Antifreeze
- Stands Up to Weather Extremes
- Double Handles On the Back and Top Make It Easy to Pick Up and Easy to Control



OEM TOOLS

Cooling System Back Flush Tool

SKU 750008 24506 **26⁹⁹**

- Size Hose Fittings: 1/2", 5/8" and 3/4"
- Connects By Using a Normal Garden Hose
- Made of Non-Corrosive Aluminum
- Easy-to-Use



OEM TOOLS

Professional Series Ethylene Glycol Antifreeze Tester

SKU 750007 24507 **16⁹⁹**

- For Testing Hot or Cold Ethylene Glycol-Based Coolants Including Dex-Cool®
- Easy-to-Read Discs Are Magnified By Convex Design of the Clear, Thermal Resistant Plastic Barrel
- Disc-Type 16-1/4" Tester Is Accurate at All Temperatures
- Celsius and Fahrenheit Scales



OEM TOOLS

4 Piece 15" Jumbo Pick Set

SKU 094658 25940 **29⁹⁹**

- Includes: Straight, 90°, Offset and Hook Pick
- Chrome Vanadium Steel for Strength and Durability
- Chrome Finish to Resist Rusting
- Cushion Grip Handles



OEM TOOLS

Fan Clutch Holding Tool

SKU 209526 27171 **49⁹⁹**

- Aids in Changing Fan Clutch By Holding the Pulley
- Fits Many GM, Ford and Dodge Vehicles



OEM TOOLS

5 Piece Fan Clutch Wrench Set

SKU 110280 27186 **79⁹⁹**

- Set Includes 5 Wrenches and 9 Sizes: 36, 40, 48, 54, 57, 68, 72, 76, 83 mm
- Ideal for Removing Fan Clutch from the Water Pump



OEM TOOLS

Master Freeze Plug Installation Tool Kit

SKU 965837 27208 **99⁹⁹**

- Designed to Remove and Install Freeze Plugs Used in Liquid-Cooled Gas and Diesel Engines
- 5 Head Adapters Fit Most Freeze Plugs
- Includes Sizes: 3/4", 1", 1-1/4", 1-1/2" and 1-3/4"
- Comes in a Sturdy Blow Mold Storage Case



OEM TOOLS

Fluid Evacuator (1.4 Gallons)

SKU 544744 24389 **79⁹⁹**

- 1.4 Gallon (5.6 Quarts, 5.3 Liters) Reservoir with Hand Operated Pump to Tackle Big Jobs
- 5' of Flex Hose and (2) Dipstick Hoses
- Leak Proof Design
- Use to Extract Most Fluid Types: Engine Oil, Transmission Fluid, Gear Oil, Coolant, Power Steering Fluid



OEM TOOLS

Fluid Evacuator 2.5 Gallons

SKU 547010 24397 **119⁹⁹**

- 2.5 Gallons (9.5 Liters)
- Extracts All Types of Engine, Transmission and Lubricating Oils from Cars, Motorcycles, Marine Engines and Industrial Machinery
- Extracts Fluids Through Dipstick Tubes As Well As Other Openings
- Float Assembly to Prevent Overflow



OEM TOOLS

Coolant Hose Removal Tool Set

SKU 383214 CAL244TNZ **29⁹⁹**

- Thicker than Most Hose Disconnect Tools
- 40° Offset Designed for Jobs in Tight Spaces
- Low-Profile Design for Ease of Use
- Set of Four Will Cover Quick Connect Hose Needs



Cal Van TOOLS

Block Testers

Block Tester

SKU 695104 33627145 **25⁹⁹**

- Locate Internal Combustion Leaks Quickly and Easily
- When Fluid Turns from Blue to Yellow a Combustion Leak Is Present



OEM TOOLS

Block Tester Test Fluid (8 Oz.)

SKU 391381 25739 **8⁹⁹**

- Use with Block Tester #33627145



OEM TOOLS

Disconnect Tools

Heater Hose Disconnect Tool

SKU 695607 33627106 **20⁹⁹**

- Removes Heater Hoses with 5/8" or 1/4" Quick Disconnect Couplings On 1986 to Current Ford Aerostar Vans and 2001 to Current Full Size Ford Vans
- Works On Rear Heater Hose Couplings On 1986 to Current Chrysler and Plymouth



OEM TOOLS

Master Disconnect Set

SKU 821445 33627318 **90⁰⁰**

- Easily Disconnects A/C Lines, Fuel Lines and Transmission Cooler Lines
- Includes: Hydraulic Clutch Line Disconnect for GM, 3/8" and 5/16" Fuel Line Retaining Clips for GM, Air Conditioning/Fuel Line Disconnects: 7/8", 3/4", 5/8", 1/2", 3/8" and 5/16"
- Scissor Disconnects: 5/16", 3/8" and 1/2", 3/8"
- Ford: Fuel Line, Oil Cooler Line and Clutch Coupling Remover
- Coupler Disconnects
- Comes in a Sturdy Blow Mold Case

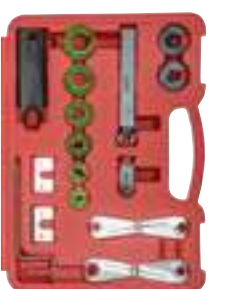

OEM TOOLS



Contact Us:
1-877-AZTool1 Phone
 (1-877-298-6651) *Hablamos Español*

Cooling System Testers

Cooling System Pressure Test Set

SKU 391374
27065 **159⁹⁹**

- (2) 32 mm (9.5 mm and 15 mm Depth) Radiator Adapters Are Included to Fit a Variety of Radiators On the Market
- Cap Adapter for These Systems Is Also Included
- System Works with Most Other Tester Systems
- Pump Is Corrosion Resistant



Works with the **OEMTOOLS** adapters below

SmartFit™ Universal Cooling System Test Kit

SKU 250709
RED950700 **199⁹⁹**

- Works On All Passenger Vehicles and Light-Duty Trucks
- Made in the U.S.A.
- Eliminates the Need to Buy Costly Adapters for Radiators
- Made from Anodized Brass and High Quality Materials in Passenger Vehicles and Light-Trucks



OEMTOOLS

Acura, Chevrolet, Chrysler, Geo, Honda, Isuzu, Lexus, Mazda, Mitsubishi, Suzuki and Toyota

SKU 133624
27244R **31⁹⁹**

- Fits Early Models Directly to Radiator with 32 mm Opening and a Depth of 9 mm



OEMTOOLS

BMW

SKU 133634
27250R **34⁹⁹**

- Fits Models with Threaded Filler Necks Up to 1987
- Diameter: 32 mm; Thread Size: 3 mm



OEMTOOLS

BMW and Range Rover

SKU 133635
27251R **29⁹⁹**

- Fits BMWs from 1988 - 2006, Land Rover and Range Rover Models 1995 - 2005
- Diameter: 52 mm; Thread Size: 4 mm



OEMTOOLS

BMW 3 Series (2006 and Later) and 5 and 6 Series (2005 and Later)

SKU 133825
27252R **34⁹⁹**

- Fits BMWs from 1988 - 2006, Land Rover and Range Rover Models 1995 - 2005
- Diameter: 52 mm; Thread Size: 3 mm



OEMTOOLS

Cadillac, Chevrolet, Geo, GMC, Pontiac, Ford, Oldsmobile and Saturn

SKU 133621
27118R **34⁹⁹**

- Fits GM 1999 and Later that Use an O-Ring Seal



OEMTOOLS

Ford, Jaguar and Mazda

SKU 133631
27247R **34⁹⁹**

- Ford Contour 1998 - 2000, Jaguar XJ8 1998 - Up, Jaguar XK8 1997 - 2006, Mazda Tribute 2001 - Up
- Diameter: 52 mm; Thread Size: 3 mm



OEMTOOLS

Mazda 3, Volvo S40/V50 and Ford Radiator Adapter

SKU 133633
27249R **34⁹⁹**

- Fits Land Rover LR-2 2008 - Up, Mazda 3 2004 - Up, Volvo S40 and V50 2004 - Up, XC60 2010 - Up, Ford 2012 and Later Fusion and Escape
- Diameter: 50 mm; Thread Size: 2.5 mm



OEMTOOLS

Mercedes and Chrysler

SKU 133626
27246R **34⁹⁹**

- Fits Mercedes-Benz with Threaded Filler Necks Except the M-Class 1998 - 2005 and Chrysler Crossfire 2004 - 2008



OEMTOOLS

Ford, Jaguar, Pontiac, Range Rover and SAAB

SKU 133611
27243R **29⁹⁹**

- Fits Jaguar X Type 2002 - Up, SAAB 900 1994 - 1998, SAAB 9-3 and 9-5 1999 - Up, Some Saturns and Numerous Vehicles
- Diameter: 52 mm; Thread Size: 3 mm



OEMTOOLS

Import

SKU 695123
33627112 **45⁹⁹**

- Fits Nissan, Datsun, Mitsubishi, Mazda, Subaru and Toyota Systems
- Also Fits Honda Motorcycles with a 45 mm Cap
- Diameter: 32 mm; Depth: 16 mm



OEMTOOLS

Toyota, Lexus and Scion

SKU 133632
27248R **34⁹⁹**

- Fits Lexus LS 2007 - Up, Toyota Celica 2000 - Up, Spyder MR2 2000 - Up, RAV4 2009 - Up, Prius 2004 - Up, Camry 2007 - Up, Highlander 2006 - Up and Scion XB 2008 - Up



OEMTOOLS

Volvo, SAAB, Jeep, Maserati and Ferrari

SKU 133600
27241R **29⁹⁹**

- Fits Maserati and Ferrari Models 2000 - Up, Jeeps with Male Threads 1990 - 1994, SAAB 900 1978 - 1993, SAAB 900 Drop Top 1994, SAAB 9000 1987 - 1998, Volvos with Male Threaded Necks
- Diameter: 45 mm; Thread Size: 3 mm



OEMTOOLS

Audi and VW

SKU 133549
27240R **29⁹⁹**

- Fits Audi with Male Threads On Filler Neck, Porsche Boxster 1997 - Up, Cayman 2006 - Up, 911 1999 - Up, Volkswagens with Male Threads On Filler Neck
- Outside Diameter: 48 mm; Thread Size: 3 mm



OEMTOOLS

Audi and VW

SKU 133625
27245R **34⁹⁹**

- Fits Audi A4 1996 - Up, A6 1998 - Up, A8 1997 - Up, S4 2004 - Up, TT 2000 - Up, Bentley 2006 - Up, Lamborghini 2006 - Up, Porsche Cayenne 2003 - Up, Porsche Panamera 2010 - Up, Volkswagen Passat 1998 - Up, Beetle 1998 - Up, Golf and Jetta 1999 - Up



OEMTOOLS

VW

SKU 133609
27242R **29⁹⁹**

- Fits Volkswagens with Female Threaded Filler Necks 1990 - 1998



Fluid Handling Equipment

Coolant Pulsator Cooling System Flush Tool

SKU 012619
HCT118550 **699⁹⁹**

- Reduce Comebacks Caused By Low Coolant Flow and Premature Water Pump Failure
- Patented Pulsating Design Removes Restrictive Sludge, Debris, Casting Sand and Scale Deposits to Return Flow to Like New
- Included Accessories Connect with Quick Coupler - Large Rubber Cone, Whip Hose with Small Rubber Cone, 5/8" and 3/4" Hose Barb Connectors and Back Flow Preventer



FluidPRO® ATX-2+Boost Transmission Fluid Exchanger

SKU 573105
MSS4008000800 **3,799⁹⁹**

- Fully Automatic Operation
- Precision Fluid Measurement to Minimize Technician Input
- Digital Weight Scale Technology for Accurate Fluid Exchange
- Transmission Pressure Diagnostics

NEW



MAHLE

Fluid not included.

FluidPRO® ATX-3+Boost Transmission Fluid Exchanger

SKU 574434
MSS4008000900 **4,299⁹⁹**

- 'Dipstick' or 'Cooler' Mode Selector
- Fully Automatic Operation
- Precision Fluid Measurement to Minimize Technician Input
- Digital Weight Scale Technology for Accurate Fluid Exchange
- Transmission Pressure Diagnostics

NEW



MAHLE

Fluid not included.

FluidPRO® ATX+Boost/PS Combo Power Steering/Transmission Unit

SKU 572461
MSS4158001400 **4,299⁹⁹**

- PSX-3 Mounted On Back of ATX 2 Machine
- Fluid Flow Direction Indicator Verifies Correct Hook-Up
- Transmission Diagnostic Pressure Gauge
- Process Time: 3 to 6 Minutes Average Full Exchange

NEW



MAHLE

Fluid not included.

ATF1 Transmission Fluid Exchanger

SKU 112434
SYM30110000 **4,599⁹⁹**

- Cooler Line and Dipstick Modes of Operation
- No Co-Mingling of New and Used Fluids
- High Output, Controlled Drainage at 3 Gallons per Minute
- External Mounted Filter for Easy Maintenance
- Adapter Kit Included



FluidPRO® ATX-3+Boost/PS Combo Power Steering/Transmission Fluid Exchanger

SKU 572537
MSS4158001900 **4,799⁹⁹**

- PSX-3 Mounted On Back of ATX 3 Machine
- Fluid Flow Direction Indicator Verifies Correct Hook-Up
- Transmission Diagnostic Pressure Gauge
- Process Time: 3 to 6 Minutes Average Full Exchange
- Includes Dipstick Service Mode

NEW



MAHLE

Fluid not included.

VCX-1 Vacuum Coolant Exchanger

SKU 573048
MSS4708001900 **2,499⁹⁹**

- Extremely Fast Service Cycles
- Simple Hook-Up and Operation
- Flexible Adaptation for Most Makes and Models

NEW



MAHLE

Fluid not included.

FluidPRO® MCX-2 Multi-Coolant System Fluid Exchanger

SKU 574749
MSS4708003000 **2,499⁹⁹**

- Includes System Pressure Test and "Hot Car" Radiator Cap Release
- Compatible with All Coolant Types Adaptability
- Contains Two 7.5 Gallon New Coolant Tanks and One 15 Gallon Waste Tank Provides Simple, Rapid Switching from One Coolant to Another
- Fast Service Times of Minutes for Increased Productivity

NEW



MAHLE

Fluid not included.

FluidPRO® MCX-2HD Multi-Coolant System Fluid Exchanger

SKU 575159
MSS4708003200 **2,799⁹⁹**

- Compatible with All Coolant Types for Adaptability
- Contains Two 15 Gallon New Coolant Tanks and One 15 Gallon Waste Tank Provides Simple, Rapid Switching from One Coolant to Another
- Fast Service Times of 3 Minutes for Increased Productivity



NEW

VFX1 Radiator Coolant Exchanger

SKU 112467
SYM35010000 **2,899⁹⁹**

- Dual Mode Functionality, In-Line Back Flush or Vacuum Drain-N-Fill
- With the Vacuum Capability, Air Locks Are Eliminated Quickly
- Shop Air Operation
- Multi-Fluid Tank Exchange, (2) Interchangeable New Fluid Tanks
- 15 Gallon Used Fluid Tank
- High Efficiency "Engine Off" Flush
- Pressure Check/Vacuum Test
- All Adapters Included

NEW



MAHLE

Fluid not included.

Mahle FluidPRO® VCX-4 Vacuum Coolant Exchanger

SKU 574376
MSS4708002000 **3,649⁹⁹**

- Four Transparent, Large Capacity Cylinders; Three for New Coolant and One for Waste
- Easy Coolant Selection/Changeover for Flexible Adaptation of Most Vehicles
- Fast Service Cycles of 5-15 Minutes for Increased Productivity

NEW

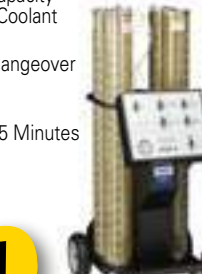

MAHLE

Fluid not included.

Brake Flush System

SKU 850060
MSSBFX3 **3,699⁹⁹**

- Three-Step Process Takes Less Than 10 Minutes
- Universal Adapter for Variety of Master Cylinders Included
- Includes Pistol Wand for Convenient and Accurate Fill
- Pressure Gauge to Assist in Brake System Diagnosis

NEW



MAHLE

Fluid not included.

FluidPRO® DFX-1 for Differential Fluid Exchange

SKU 572560
MSS4458000100 **1,299⁹⁹**

- Services All Gear Oils Including Synthetic for Increased Compatibility
- Automatic Operation for Improved Technician Efficiency
- Valved-Hose Ends to Prevent Fluid Spill and Ensure Clean Operation



NEW

Fluid not included.

FluidPRO® PSX-3 Power Steering Fluid Exchange System

SKU 850063
MSSPSX3 **999⁹⁹**

- Multiple power steering fluid capability for increased compatibility
- Dual diaphragm-type pumps for speedy service times of 5-15 minutes
- Quick and easy changeover between different power steering fluid types of the PSX-3 allows for improved technician productivity

NEW



Fluid not included.

DIAGNOSTIC

Autel MaxiSys®

BLUETOOTH COMMUNICATION VCI MaxiSYS® Mini with Connector Kit

SKU 464051
AULMS905K **1,694⁹⁹**



BLUETOOTH COMMUNICATION VCI UPGRADEABLE TO PRO WITH AULMF2534 MaxiSYS® Diagnostic Scan Tool System

SKU 464052
AULMS908 **2,699⁹⁹**



BJ2534 PASS-THRU PROGRAMMING DEVICE WITH INTERNAL BLUETOOTH VCI MaxiSYS® Pro Diagnostic Scan Tool System

SKU 543358
AULMS908PRO **3,694⁹⁹**



DIAGNOSTIC TOOL of the MONTH
SEPTEMBER PLUS BONUS
SEE INSERT FOR DETAILS

	AULMS905K	AULMS908	AULMS908PRO
Bluetooth Connection VCI	Yes	Yes	Yes
Complete Connector Kit	Yes	Yes	Yes
8" Screen	Yes	No	No
10" Screen	No	Yes	Yes
Key Programming	Yes	Yes	Yes
OE-Level Vehicle Coverage and Diagnostic Functionality	Yes	Yes	Yes
Upgradeable to MaxiSys Pro with J2534	No	Yes, with purchase of AULMF2534 SKU 005455 \$1249.99	Included
Includes 1 Year of Free Software Updates	Yes	Yes	Yes
Additional 1 Year Total Care Package Available	Yes, with purchase of AULMS905-1YRUP SKU 848003 \$689.99	Yes, with purchase of AULMS908-1YR SKU 079901 \$729.99	Yes, with purchase of AULMS908P-1YR SKU 079925 \$1199.99



Autel TPMS Tools

GOOD

READS SENSOR PRESSURE AND TEMPS
MaxiTPMS® TS401 Diagnostic and Service Tool

SKU 255740
AULTS401 **279⁹⁹**



BETTER

READS / WRITES SENSOR IDS
MaxiTPMS® TS501K Diagnostic and Service Tool with 8 TPMS Sensors (Sensors \$319.00 Value)

SKU 850650
AULTS501K **549⁹⁹**



BEST

SHOWS TPMS LIVE DATA
MaxiTPMS® TS601 All-In-One TPMS Tool with OBDII

SKU 376934
AULTS601 **959⁹⁹**



	AULTS401	AULTS501K	AULTS601
Activate Sensors and Retrieve Data	Yes	Yes	Yes
Display Relearn Procedures	Yes	Yes	Yes
Step-by-Step Graphic Direction for OE Relearn Procedures	Yes	Yes	Yes
Autel MX Sensor Programming Capabilities	Yes	Yes	Yes
OBDII Interface to Extract TPMS Codes	No	Yes	Yes
Detect and Display TPMS System Faults	No	Yes	Yes
Read and Clear TPMS Information	No	Yes	Yes
Complete TPMS System Diagnostics	No	No	Yes
Live TPMS Data Stream	No	No	Yes
Adjust Tire Size Placard Values	No	No	Yes
Receives Both 315Mhz and 433Mhz Sensors	Yes	Yes	Yes
Includes 6 Metal Stem and 2 Rubber Stem Sensors	No	Yes	No

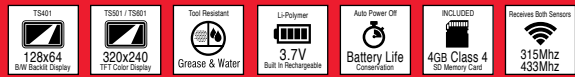

Autel Diagnostic Tools

Diagnoses All 1996 and Newer OBD II Compliant Vehicles

AutoLink® OBDII/CAN Code Reader with Color Screen

DIAGNOSTIC TOOL of the MONTH
JULY
SEE INSERT FOR DETAILS

SAVE \$10

SKU 222492
AULAL319 **59⁹⁹**

Reads Live Data

- Bright Color Coded LEDs and Built-In Speaker
- Retrieves Generic, Manufacturer Specific, and Pending Codes
- Determines the Cause of the Malfunction Indicator Light
- Turns Off Malfunction Indicator Light, Clears Codes and Resets Monitors
- Displays DTC Definitions on the TFT Color Screen
- Views Freeze Frame Data
- Displays Monitor and I/M Readiness Status



AutoLink® OBDII/EOBD Scan Tool

SKU 222488
AULAL419 **99⁹⁹**

- Features Patented 1 Click I/M Readiness Key
- Troubleshooter Code Tips Guide Technicians
- Prints Data Via PC
- Bright Color Coded LEDs and Built-In Speaker
- Retrieves Generic, Manufacturer Specific, and Pending Codes
- Determines the Cause of the Malfunction Indicator Light
- Turns Off Malfunction Indicator Light, Clears Codes and Resets Monitors
- Displays DTC Definitions on the TFT Color Screen
- Retrieves VIN, CIN, and CVN Information
- Internet Updateable and Upgradeable



AutoLink® Enhanced OBDII Scan Tool

SKU 222483
AULAL519 **124⁹⁹**

- Enhanced OBDII Mode 6
- Features Patented 1 Click I/M Readiness Key
- Troubleshooter Code Tips Guide Technicians
- Prints Data Via PC
- Bright Color Coded LEDs and Built-In Speaker
- Retrieves Generic, Manufacturer Specific, and Pending Codes
- Determines the Cause and Resets the Malfunction Indicator Light
- Displays DTC Definitions on the TFT Color Screen
- Retrieves VIN, CIN, and CVN Information



AutoLink® OBDII and Electrical Test Tool

SKU 222487
AULAL439 **149⁹⁹**

- AVO-Meter Read Voltage and Resistance
- Capable of Diagnosing 12V Charging and Starting Systems
- Features Patented 1 Click I/M Readiness Key
- Prints Data Via PC
- Bright Color Coded LEDs and Built-In Speaker
- Retrieves Generic, Manufacturer Specific, and Pending Codes
- Determines the Cause and Resets the Malfunction Indicator Light
- Retrieves VIN, CIN, and CVN Information
- Internet Updateable and Upgradeable



AutoLink® Enhanced OBDII and Electrical Test Tool

SKU 222509
AULAL539 **159⁹⁹**

- Reads live PCM, O2 Sensor Test, and Freeze Frame Data
- Visually Graphs Data (1996 and Newer)
- AVO-Meter Read Voltage and Resistance
- Capable of Diagnosing 12V Charging and Starting Systems
- Features Patented 1 Click I/M Readiness Key
- Prints Data Via PC
- Bright Color Coded LEDs and Built-In Speaker
- Retrieves Generic, Manufacturer Specific, and Pending Codes
- Determines the Cause and Resets the Malfunction Indicator Light
- Retrieves VIN, CIN, and CVN Information
- Internet Updateable and Upgradeable



AutoLink® OBDII, CAN, ABS, and SRS Scan Tool

SKU 227784
AULAL619 **199⁹⁹**

- Analyzes ABS/SRS System Codes
- Reads, Stores, and Playbacks Live PCM Datastream and Sensor Data
- Visually Graphs Data
- Prints Data Via PC
- Retrieves Generic, Manufacturer Specific, and Pending Codes
- Diagnoses and Resets the Malfunction Indicator Light and ABS/SRS Warning Lights
- Retrieves VIN, CIN, and CVN Information
- TF Memory Card for Data Backup and Software Update



MaxiCheck® Pro Diagnostics Scan Tool for EPB, ABS, SRS, SAS, and TPMS

SKU 222473
AULMAXICHECKPRO **439⁹⁹**

- Crystal Clear TFT Color Screen
- USB Internet Updateable and Upgradeable
- Opens and Closes Electronic Brake Calipers
- Reads and Clears EPB/SBC Trouble Codes
- Turns off the ECU and Brake Warning Lights
- Diagnoses EPB/SBC Caliper Functionality
- Resets the Oil Service Light, Service Mileage, and Service Intervals
- Resets Steering Angle Sensors (SAS)
- ABS and SRS Coverage for 50+ Vehicle Makes - U.S. Domestic, Asian and European
- Reads, Records and Plays Back OBD2 Live Data Graphing



5.5mm MaxiVideo Inspection Camera

SKU 079943
AULMV105 **139⁹⁹**

- 5.5 mm (0.22") Diameter Image Head
- Flexible Imager Head and Cable Reach to 3.3'
- Adjustable, White LED Lights Inspection Area
- Waterproof Head and Cable to 10'
- USB Compatible
- Includes Magnet, Mirror, Hook Attachments



NEW

8.5mm MaxiVideo Inspection Camera

SKU 079977
AULMV108 **119⁹⁹**

- 8.5 mm (0.22") Diameter Image Head
- Flexible Imager Head and Cable Reach to 3.3'
- Adjustable, White LED Lights Inspection Area
- Waterproof Head and Cable to 10'
- USB Compatible
- Includes Magnet, Mirror, Hook Attachments



NEW



Contact Us:
1-877-AZTool1 Phone
 (1-877-298-6651) *Hablamos Español*

AutoZone® Tool & Equipment QUARTERLY

Analyze, Diagnose, and Repair Today's Vehicles Faster



MSS4028000100



MSS4028000400



MSS4028000600

SKU	Part Number		Price
080045	MSS4028000100	Automotive Diagnostic System, includes VCI1000 and 1-year subscription	1,599⁹⁹
080072	MSS4028000400	402 80001 00 plus 8" tablet with preloaded software	1,999⁹⁹
080027	MSS4028000600	402 80001 00 plus 10" tablet with preloaded software	2,299⁹⁹

TechPRO® Automotive Diagnostic System

MAHLE's TechPRO® Diagnostic Scan Tool is the most advanced technology available for professional technicians. This versatile, software-based tool helps analyze, diagnose and repair today's sophisticated vehicles faster and more accurately than ever before.

Decades of providing diagnostics to OEM's end-of-line manufacturing test systems: now bringing this speed and stability to an aftermarket scan tool for the first time.

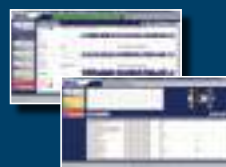

SMART Technology

MAHLE

Driven by performance

SPEED.

Decode a VIN in seconds with 1 click. Communicates with all modules and reports all DTC's in 20-30 seconds on average.

COST.

Subscription-based model vs. large initial investment.

FUNCTIONALITY.

Use with existing tablet, laptop, or desktop with no need to purchase additional hardware. (Windows 7, 8 or 10) TechPRO® Diagnostic Scan Tool can be purchased with the option of a tablet bundle.

DATA.

Real-time streaming data, with software updates downloaded rapidly from the Internet.

RESOURCE.

History is collected on every component of the analysis with instant pass-thru to repair data for subscribers of Identifix, Mitchell 1, iATN and more...

TECH-FRIENDLY.

Bright LED light confirms that VCI is communicating and audible alarm reminds technicians to disconnect.

TechPRO®

INNOVA PRO



CarScan Code Reader™
 sku: 514004
 INN30203 **59⁹⁹**

CarScan Diagnostic Tool™
 sku: 509778
 INN31003 **119⁹⁹**

SAVE \$30
 REG. \$149.99

CarScan + OBD1
 sku: 504203
 INN31403 **259⁹⁹**

SAVE \$80
 REG. \$339.99

ABS/SRS + OBD2® Scan Tool
 sku: 504259
 INN31603 **249⁹⁹**

SAVE \$100
 REG. \$349.99

CarScan + OBD1 & SRS/ABS
 sku: 504457
 INN31703 **389⁹⁹**

SAVE \$160
 REG. \$549.99

Offers Good Through September 30, 2016 - While Supplies Last

Features and Functions

	30203	31003	31403	31603	31703
1996 - Present (OBD2 Compliant) - Domestic, Asian and European	■	■	■	■	■
CAN and 2010+ Model Diesel and Hybrid Compliance	■	■	■	■	■
Patented All-in-One Display Shows 20+ Values on One Screen	■	■	■	■	■
Vehicle Health Monitor LED's - Confirm Safe Emissions Test	■	■	■	■	■
Emissions Readiness Advisor - Complete OBD Trip + Drive Cycles	■	■	■	■	■
VIN# Decoder - Detailed Vehicle Identification for Quick Diagnostics	■	■	■	■	■
Retrieve Manufacturer Specific, Global and Pending Codes	■	■	■	■	■
Erase Button Turns Off "Check Engine" Light	■	■	■	■	■
Customer Service - Mon-Sat, 6am-6pm, PST - English/Spanish	■	■	■	■	■
Vehicle Information - VIN # - Mode 9	■	■	■	■	■
Multilingual - On Screen Definitions in English/Spanish	■	■	■	■	■
Battery Backup for Off Vehicle Data Review	■	■	■	■	■
Displays Freeze Frame Data	■	■	■	■	■
OBD2 Live-Data Stream Display	■	■	■	■	■
RepairSolutions® with VIN Specific Fixes and Procedures - Optional	■	■	■	■	■
Internet Updateable and Upgradeable	■	■	■	■	■
Enhanced Engine and Transmission Codes	■	■	■	■	■
OBD2 - All 10 Modes	■	■	■	■	■
Record, Graph and Play Back OBD2 Live Data on Tool	■	■	■	■	■
ABS/SRS Most 1996-08 GM, Ford, Chrysler, Toyota, Honda DTC's			Optional	■	■
OBD1 - Ford, GM, Chrysler, Toyota, Honda DTC's			■	Optional	■
Shop Management Software - Print and Manage Vehicle Diagnostic Reports	■	■	■	■	■

Scan Tools

Code Buddy PRO OBDII Code Scanner

SKU 802332 **79⁹⁹**
 ESJ903

- Reads LIVE DATA STREAM
- Works On All 1996 and Later OBDII Compliant US, European and Asian Vehicles
- Clears Codes, Turns Off MIL and Resets Monitors
- Built-In OBDII Fault Code Lookup Library



iOBDII Code Reader

SKU 462982 **99⁹⁹**
 CDOIOBD2

- Works for Both iPhone and Android Phones and Communicates Via WiFi
- Read and Clear Codes
- Read and Record Live Data Stream
- Read Freeze Frame Data, Vehicle Information
- O2 Sensor Testing
- Mode 6 Testing
- Evaporative Emission System Leak Detection
- Customizable My Dashboard
- Includes Many Features Not Available or Cost Extra On Other Bluetooth OBDII Adapters



*Phone Not Included

Wirelessly Connects to Either iPhone® or Android™ Smart Phones and Tablets via Bluetooth™

Cando Battery Reset Tool

SKU 572412 **149⁹⁹**
 CD0CDBATTBMC

- Perform Battery Resets on: BMW/Mini, VW/Audi, Jaguar, Land Rover, Ford and more.

NEW



Some New Vehicles Require a Scan Tool to Reset the Battery Life in the Vehicle's Computer When Replacing the Battery. Failure to do so Can Cause Over Charging, Shorten the Battery Life and/or Enable Limp-Home Mode and Even a no Start Situation.

The Cando Battery Reset Tool is Reliable, Affordable and Easy to Use.

RESET + Oil, Brake and Service Maintenance Reset Tool

SKU 462980 **169⁹⁹**
 CD0RESETP

- Reset Oil and Service Reminder Lights On Vehicles 1996 and Newer
- On-Screen Instructions Included for Manually Reset Vehicles
- Free Internet Updates Ensures Communications with the Latest Vehicles



OBDII Code Reader with Heavy Duty Coverage

SKU 695642 **449⁹⁹**
 CDOHDCODEPCAT

- Works On All 1996 and Newer Can-Bus Compliant Diesel and Gas Vehicles
- Class 4 to Class 8 Coverage with Automatic Protocol Search
- OBDII, EOBD and CAN Coverage for Gasoline and Diesel Engines
- Covers Engine, ABS and Transmission
- Read and Clear Codes, As Well As View and Graph Live Data
- Updated Software for Hybrid HD Trucks
- Updated CAT 9 Cable and Software for Caterpillar
- Updated Software for International, HINO and Isuzu



Brake, Oil and Service Light Reset + Tool

SKU 793568 **245⁰⁰**
 33627302

- Used to Reset Oil Service Light, Service Mileage, Service Intervals, Vehicle Inspection, Engine Oil, Front and Rear Brake, Brake Fluid, Dust Filter and Spark Plugs On Most Major Asian, American and European Vehicles
- Easy, Step-by-Step On-Screen Instructions
- Automatic or Manual Reset Option
- Includes USB Cable and OBDII Connectors
- Comes in a Blow Mold Case



DIAGNOSTIC

SAVE \$50

Cylinder Leak Down Test Kit

SKU 347237
27267 **109⁹⁹** REG. \$159.99

- Includes Precision Regulator with a Combination M14/M18 Adapter, 26" Hose Plus M10, M14 and M18 Solid Long Reach Adapters and Extra O-Rings Included
- Displays Leakage As a Percentage
- Comes in a Blow Mold Case



Offer Good Through September 30, 2016 - While Supplies Last

Inspection Cameras

MaxiVideo[®] MV208-8.5 Digital Videoscope

SKU 222475
AULMV208-8.5 **139⁹⁹**

- 2.4" Hi-Res Color LCD Display (320 x 240)
- Easy-to-Use, Multi-Language Interface
- Wide Camera Angle with 640 x 480 Resolution
- Probe Diameter of 8.5 mm



MaxiVideo[®] MV208-5.5 Digital Videoscope

SKU 255816
AULMV208-5.5 **159⁹⁹**

- 2.4" Hi-Res Color LCD Display (320x240)
- Easy-to-Use, Multi-Language Interface
- Wide Camera Angle with 640 x 480 Resolution
- Probe Diameter of 5.5 mm



MaxiVideo[®] MV400-5.5 Digital Videoscope

SKU 222477
AULMV400-5.5 **199⁹⁹**

- 3.5" Hi-Res Color LCD Display (320 x 240)
- Removable SD Card for Images and Video
- Easy-to-Use, Multi-Language Interface
- Wide Camera Angle with 640 x 480 Resolution
- Probe Diameter of 5.5 mm



SAVE \$50

Master Compression Test Kit

SKU 347236
27266 **99⁹⁹** REG. \$149.99

- Includes 2-1/2" 0 - 300 PSI Gauge with 10" Hose, Quick Connect and Protective Boot, Plus 1-1/2" 0 - 200 PSI Gauge for Small Engines
- (2) Separate M14 Hoses, (Short Thread and Long Thread) M18 Hose, M10, M12 and M18 Solid Adapter
- Extra O-Rings and Valve Cores Included
- Comes in a Blow Mold Case



Offer Good Through September 30, 2016 - While Supplies Last

Borescope with 2.4" Color LCD Screen

SKU 544746
24383 **149⁹⁹**

- Resolution: 640 x 480
- Adjustable LEDs Illuminate the Inspection Area
- 9 mm Probe
- 1 Meter Flexible Shaft
- Includes: Magnet, Mirror and Hook All in a Blow Mold Case



2.7" LCD Inspection Camera

SKU 813284
W50046 **159⁹⁹**

- Full Function Camera with Image Camera and Video Playback/Record
- 2.7" Color LCD Monitor with 640 x 480 VGA Resolution Camera and Image Rotation
- Submersible 11/32" (9 mm) Diameter Camera
- 4 White LEDs with 6 Output Levels
- 40" (100 mm) Flexible Neck
- 32 MB Built-In Memory, Micro SD Card Slot and TV/Video Output Jack
- Includes Mirror, Hook Clip, Magnet, USB Cable and Video Cable
- Requires 4AA Batteries (Included)
- Great for Inspecting Engine Compartment, Valves, A/C Vents, Plumbing Pipes, Under or Around Furniture and Appliances, Home Theater Installations, Cable Routing, Pest Control and Machinery



PT
Performance Tool

2.4" LCD Inspection Camera

SKU 802203
AZ5004 **109⁹⁹**

- 2.4" Color LCD Monitor with 320 x 240 VGA Resolution and 180° Image Rotation and Mirroring
- Submersible 11/32" (9 mm) Diameter Camera with 640 x 480 Resolution
- 4 White LEDs with 6 Output Levels
- 40" (1 M) Flexible Neck
- TV/Video Output Jack
- Useful for Inspecting Engine Compartment, Valves, A/C Vents, Plumbing Pipes, Under or Around Furniture and Appliances, Home Theater Installations, Cable Routing, Pest Control and Machinery
- Includes Mirror, Hook Clip, Magnet and Video Cable
- Requires 4AA Batteries (Included)



Duralast

Fuel and Engine

Exhaust Back Pressure Tester/Gauge

SKU 347232
27263 **69⁹⁹**

- Oxygen Sensor Adapter Is M12 and M18 Thread
- 6" Hose Allows User to Test from Driver's Seat
- Comes in a Blow Mold Case
- Test for Restricted Exhaust Systems



Oil Pressure Gauge Set

SKU 347229
27262 **79⁹⁹**

- For Use On Diesel and Gasoline Engines
- Includes Standard and Metric Adapters Found On Most Cars and Trucks
- 2-1/2" Easy-to-Read Gauge with Protective Boot
- Comes in a Blow Mold Case



Fuel Injection Cleaner Kit

SKU 517582
MITMV5567 **424⁹⁹**

- Complete Fuel Injector Cleaning Kit Combining the Cleaner with Connection Hose (MV5565) and Connection Adapter Kit (MVA565)
- It Can Be Upgraded to an Air Induction Cleaner By Adding MVA550 Decarb Nozzle
- Quickly and Cleanly Removes and Prevents Fuel Injector Deposits, and Loosens and Dissolves Carbon On Intake Manifold and Valves
- Enhances Engine Performance Improves Fuel Economy, Reduces Maintenance and Improves Emission
- Uses Standard Shop Air to Deliver Cleaning Solution Directly into the Fuel Stream or Spray it into the Air Induction System (MVA550 Required for Induction System Cleaning)



mityvac

Fuel Pressure Test Kit

SKU 988887
MITMV5546 **444⁹⁹**

- Contains (37) Adapters for Pressure Testing Most US, Asian and European Manufactured Vehicles
- High Quality, Heavy Duty Gauge with 0 - 120 PSI (0 - 8 Bar) Scale, Protective Rubber Boot and Push Button Pressure Relief Valve
- Uses SAE Certified, Fuel-Rated Quick Connects for Reliability, Ease of Use and Interchangeability
- Easily Upgrades to a Fuel Pressure and Flow Tester with the Addition of Flow Meter Upgrade Kit MVA5553



Fuel System Tester

SKU 988886
MITMV5545 **649⁹⁹**

- Measures Fuel System Pressure and Flow to Accurately Pinpoint Fuel System Failures
- Saves Hours of Troubleshooting Time By Diagnosing a Bad Fuel Pump and Other Related Drive Ability Problems in Seconds
- Patented System Simulates Extreme Driving Conditions in the Shop to Provide the Most Accurate Diagnosis
- Capable of Testing Both Return and Return Less Fuel Systems Including Electronic Control
- Provides Clear Visualization of Fuel to Detect Impurities and Air Bubbles



Diagnose and Pinpoint Common Fuel System Failures Including Failing Fuel Pump, Faulty Pressure Regulator, Blocked Filter(s), Pinched Fuel Line, Contaminated Fuel and Fuel Tank Vortex.

mityvac

Compression Testers

Professional Compression Test Kit

SKU 972276
MITMV5530 **84⁹⁹**

- Includes 10, 12, 14 and 18 mm Adapters
- Extended Hoses for Hard-to-Reach Cylinders
- Large 2-3/4" Easy-to-Read Gauge
- Quick Disconnect Fittings

Everything You Need to Perform Cylinder Compression Tests on Motorcycles, Marine and Small Engines, and an Air-Hold Adapter for Performing Valve Seal Repairs



Fuel Pressure Test Kit

SKU 347235
27265 **159⁹⁹**

- Designed Around Quick Connect Adapters
- Includes 3-1/2" Heavy Duty Gauge with Protective Boot, Large and Small Schrader Adapters, M6-1.00 Banjo Adapter, Double End Tee for 5/16" and 3/8" and Single End Connector for 1/4", 5/16" and 3/8"
- Range: 0 - 150 PSI
- Comes in a Blow Mold Case



OEM TOOLS

Digital Gas Engine Compression Test Kit

SKU 383182
MITMV5532 **154⁹⁹**

- Stores Maximum Compression Value for Up to 12 Cylinders
- 3 Minute Auto Shut-Off
- Sealed, Grease and Oil-Resistant Gauge Face Prevents Contamination of Electronics
- Displays Values in PSI, Bar and kPa



Digital Diesel Compression Test Kit

SKU 988885
MITMV5535 **279⁹⁹**

- Features an Electronic Tester that Memorizes Peak Values for Each Cylinder
- Includes: Injector Adapter (Dodge 24V 5.9L Cummins (1999-2003), 5.9L Cummins ISB and ISBE), Injector Adapter (Case/Cummins Series "B" 2.9L, 3.9L, 5.9L Through 1998), Glow Plug Adapter (GM 4.3L, 5.7L (1978-1985), Navistar 6.9L, 7.3L Through 1994), Glow Plug Adapter (GM 6.2L, 6.5L V8), Glow Plug Adapter (Ford/Navistar 7.3L Power Stroke (1994-2003), Glow Plug Adapter (Volkswagen 1.9L TDI) and Right-Angle Adapter



Diesel Glow Plug Adapter

SKU 420348
MITMVA5611 **59⁹⁹**

- Used for Isuzu (Duramax) 6600
- Glow Plug Adapter - M10 x 1.0



Ford 6 Liter Adapter

SKU 972279
MITMVA5610 **29⁹⁹**

- Glow Plug Adapter M14 x 1.25
- International V3365
- Ford Power Stroke, 6.0 Liter Engine





Contact Us:
1-877-AZTool1 Phone
 (1-877-298-6651) *Hablamos Español*

Smoke Leak Detectors

SmokePro® Tech-Mate Plus™

SKU 543388
 RED95-0007A **749⁹⁹**

NEW LOWER PRICE



- (1) Smoke Pro® Tech-Mate Plus™
- (1) OEM-Approved Smoke Agent
- (1) Halogen Inspection Light
- (1) EVAP Service Port Tool
- (1) EVAP Schrader Valve Removal Tool
- (1) Cap Plug Kit
- (1) Exhaust Cone Adapter
- (1) Plastic Accessory Case
- Online Training Videos Provided



SAVE \$100

Smoke Diagnostic Machine

SKU 544732
 24534 **599⁹⁹** REG: \$699.99



- To Help Technicians Diagnose Trouble Codes On Domestic and Import Cars and Light-Trucks
- Also for Testing of Oil Leaks, Wind Leaks, EGR Leaks and More
- Finds Leaks Fast
- Includes Variable Flow Control and Integrated Regulator that Detect Leaks in the System with Smoke
- Works for Turbo Systems, Engine Block, Fuel System and Exhaust Systems
- 12 Volt with Automatic Off Switch
- Works with Standard Mineral Oil



Offer Good Through September 30, 2016 - While Supplies Last

Smoke Producing Fluid (8 Oz.)

SKU 802333
 RED96-0039 **19⁹⁹**

- Contains No Dye or Other Contaminants
- Works in Most EVAP Smoke Machines



EasyEVAP™ Universal Filler Neck Connector

SKU 343405
 RED95-0030 **159⁹⁹**

- Compatible with Any Smoke Machine and Removes Cleanly from the Gas Cap
- Essential Tool for Late Model Cars with Fuel Tank Rollover Valves



SmokePro® Master Tech Pack™

SKU 250694
 RED95-0019B **1,199⁹⁹**

- Speed Up Diagnostics, Improve Accuracy in Repairs, Heighten Customer Satisfaction and Increase Profits
- Minimum Leak Detection: 0.010
- Operating Modes: Air-Only Cycle - Smoke Cycle
- Includes: (1) Smoke Pro® Total Tech™, (1) Hook, (1) Hex Key, (3) OEM-Approved Smoke Agent, (1) EVAP Service Tool Kit, (1) Halogen Inspection Light, (1) Cap Plug Kit, (2) Standard Cone Adapter, (1) Plastic Storage Case, (1) Universal Filler Neck Connector, (2) Sealing Disks, (1) Smoke Output Hose



Glow Plug Reader

Glow Plug Reader

SKU 531174
 CDOGPR **219⁹⁹**



- Uses a Resistance Test with Diagnostic Algorithms to Provide an Accurate Diagnostic Result
- No Voltage Applied, Preventing Damage to Expensive Components
- Tests All Plugs Up to 24V On or Off the Car
- Results with Actual Condition Displayed On Backlit Digital Display
- Built-In LED Flashlight
- for Testing in Low Light Conditions



Probes

Electrical Back Probe Kit

SKU 511020
 THX490 **34⁹⁹**

- Kit Contains 20 Pin-Type Back Probes
- Smaller Pins for Tough to Test Areas
- Color Coded for Easier Testing



Extended Heavy Duty Back Probe Kit

SKU 511028
 THX490X **39⁹⁹**

- Contains 8 Extended Electrical Back Probes
- Used to Access Electrical Circuits from the Back Side of the Connector
- Color Coded in 4 Variations for Easier Testing



Heavy Duty Electrical Back Probe Kit

SKU 511021
 THX490-M **39⁹⁹**

- Have Longer Pin for Tough-to-Reach Circuits
- Kit Contains: (10) Straight Pins, (5) 90 Degree Pins, (5) 45 Degree Pins
- Color Coded for Easier Testing



SAVE \$70

Multi-Function Power/Ground Meter

SKU 300126
 24366 **79⁹⁹** REG: \$149.99



- Quickly Diagnose Circuits and Test Components
- Apply Battery Voltage or Ground with a Simple Thumb Rocker Switch
- Performs Standard Multimeter Functions: Volt, Continuity and Polarity
- Includes: Meter, 20' Extension Lead, Probe Extension, Battery Clips, Cigarette Lighter Adapter, Auxiliary Ground Lead
- Comes in a Blow Mold Case

MEASURE SPARK KV, INJECTOR FREQUENCY / PULSE



Offer Good Through September 30, 2016 - While Supplies Last

Power Probes

Power Probe III with Case and Accessories

SKU 262523
 PWPPP319FTC **169⁹⁹**

- Relay and Component Tester
- Volt Meter and Continuity Tester
- Audio Tone
- Carbon Fiber Design Housing
- 20' Jumper Lead
- Works On 12-24V Sources



Power Probe IV

SKU 802331
 PWPPP401AS **229⁹⁹**

- Supplies Power and Ground for Functional Component Testing
- Digital Volt and Ohmmeter for Circuit Testing
- Large Color LCD Screen with Easy to Navigate User Menu
- AC-RMS, AC Peak to Peak, Frequency and Pulse Width for Signal Testing
- Fuel Injector Tester for Easy Circuit Diagnosis
- PCM/ECM Driver Supplies Safe Voltage for Testing Circuits



Electrical Short/Open Circuit Finder

SKU 262525
 PWPPPECT2000 **199⁹⁹**

- Complete with "Smart" Transmitter and Receiver
- Most Common Adapters for All Connections
- Signal Injection and Tracing
- 20' Lead
- Directional Indication for Shorts
- Consists of 2 Units: the Transmitter and the Receiver



Master Electrical Test Kit

SKU 262524
 PWPPPKIT03 **369⁹⁹**



- Includes: Power Probe III, ECT2000 and Gold Series Lead Set
- Contains Gold Series 4 mm Leads and Connectors
- Continuity, Relay and Component Tester
- Works On 12-24V Sources
- Easy-to-Read Backlit Voltmeter Reads Voltage in 1/10th Volt



DID YOU KNOW?

AutoZone offers diagnostic software through ALLDATA.

Contact Your AutoZone Commercial Sales Manager for Details

DIAGNOSTIC

CRP 123P \$299.99

SKU 119870
301050231

**VIEW AND GRAPH LIVE DATA FOR ENGINE
VIEW LIVE DATA FOR ABS, SRS, AND TRANS. SYSTEMS**

- Retrieves Manufacturer Specific Enhanced Data for Domestic, Asian and European vehicles
- Reads and Records Data Streams for ABS, SRS, Transmission and Engine
- Auto ID Vehicles, Auto Module Search & Fast Protocol ID
- Reads and clears codes on Engine, Transmission (A/T), ABS, and Airbag (SRS) systems – on all makes and all models (16 Pin)
- Support for all 10 test modes of OBD II with Enhanced OBD II Mode 6
- Retrieves generic and manufacturer specific codes – Current, Permanent & Pending
- View freeze frame data and I/M Readiness monitor status
- Graph, record, and replay data in full color
- Menu with DTC definitions in English, Spanish & French
- Free Internet updates (USB 2.0)
- 4.0" TFT color display



**NEW!
LARGER
SCREEN**

CRP 129P \$499.99

SKU 119868
301050232

ELECTRONIC PARKING BRAKE (EPB) RELEASE, STEERING ANGLE SENSOR (SAS) RESETS AND OIL SERVICE LIGHT RESETS

- Performs Oil service light resets, Electronic Parking Brake (EPB) release, and Steering Angle Sensor (SAS) resets and Battery Reset
- Enhanced Manufacturer Specific DTCs for Domestic, Asian and European Coverage
- Reads and Records enhanced Data Streams for ABS, SRS, Transmission and Engine
- Auto Vehicle ID, Auto Module Search & Fast Protocol ID
- Reads and clears codes on Engine, Transmission (A/T), ABS, and Airbag (SRS) systems – on all makes and all models (16 Pin)
- Support for all 10 test modes of OBD II with Enhanced OBD II Mode 6
- Retrieves generic and manufacturer specific codes current, permanent and pending
- View freeze frame data and I/M Readiness monitor status
- Graph, record, and replay data in full color
- Menu with DTC definitions in English, Spanish & French



**NEW!
LARGER
SCREEN**

LAUNCH

CRP 229 \$799.99

SKU 738108
301050160

**ANDROID SCAN TOOL TABLET WITH 5 INCH
HIGH RESOLUTION LCD TOUCH SCREEN**

- Android Based and Wi-Fi Enabled for Web Browsing
- Graph Multiple PID's of Live Data
- Access All Vehicle Systems for Reading and Clearing Codes and Live Data
- Performs the Following Functions: Oil Light Resets, Electronic Parking Brake (Retract, Reset), Steering Angle Reset, Battery Registration
- OBDII 16 Pin Connector, MBZ 38 Pin and BMW 20 Pin Connector Included
- English, Spanish and French
- Padded Storage Case Included



CR-HD PLUS \$399.99

SKU 554470
301050174

**LCD DISPLAY, PROVIDES J1587, J1939,
J1708 AND OBDII DATA!**

NOW with HD & LD Gas and Diesel Coverage

- Covers Class 4 (14,001 Lbs.) Through Class 8 (33,000 Lbs. and Over) Heavy Duty Trucks
- Covers Light & Medium Duty Gas and Diesel Vehicles
- Includes 6-Pin, 9 Pin Deutsch and 16-Pin OBDII Connectors
- Coverage for Engine, Transmission, Brakes and More
- Read and Clear Active and Inactive Fault Codes
- Monitor All Data and View Live Data Streams
- Padded Storage Case
- Free Internet Updates



NEW!

CREADER V+ \$69.99

SKU 554465
3011050144

**CODE READER WITH COLOR SCREEN & LIVE
DATA GRAPHING**

- Color Screen
- View and Graph TWO PID's of Live Data
- Features O2 Sensor and Evap System Tests
- Coverage for Modes 1 Thru 10
- Permanent Codes
- Pending Codes
- Freeze Frame Data
- Free Internet Updates
- English, Spanish and French



CREADER VII \$179.99

SKU 737756
301050156

CODE READER WITH RESET CAPABILITIES

- Reset Oil and Service Reminder Lights on Vehicles 1996 and Newer
- View and Graph FOUR PID's of Live Data
- Coverage for the Latest Modes 1 Thru 10
- Freeze Frame Data
- Read and Clear DTCs
- Special Tests: *I/M Readiness, MIL Status, O2 Sensor, Evap System, Vehicle Info, Code Look-Up and On-Board Monitor Test*
- English, Spanish and French



SCANPAD 071 \$1595.99

SKU 554471
301220001P

**ANDROID SCAN TOOL TABLET WITH 7.1 INCH
HIGH RESOLUTION LCD TOUCH SCREEN**

**BUY A SCANPAD 071 AND RECEIVE A
CRP 123
AT NO CHARGE
A 299.99 VALUE!**

- Dual Core Processor Provides Fast Live Data and Graphing
- Applications for Module Coding, Resets, Relearns and Bi-Directional Capabilities Auto-ID All Available Vehicle Systems and Modules
- Full System Diagnosis Through Class-1 Bluetooth Connector
- Portable, Rugged, Drop Tested, Heavy Duty Design
- BMW 20 Pin and MBZ 30 Pin Included
- One Year Warranty
- Comes with One Year Free Upgrades



**BUY ONE
GET
ONE!**

SCANPAD 101 \$2,299.99

SKU 554468
301220002

**ANDROID SCAN TOOL TABLET WITH 10.1"
HIGH RESOLUTION LCD TOUCH SCREEN**

- Quad Core Processor for Fast Live Data and Graphing
- OE-Level Access to Asian, European and Domestic Applications for Module Coding, Resets, Relearns and Bi-Directional Capabilities
- Access to All Available Vehicle Systems and Modules
- Full System Diagnosis Through a Class-1 Bluetooth Connector
- 19 OBDII Connectors Included in a Blow Molded Case
- Rugged, Drop Tested, Heavy Duty Design
- One Year Warranty
- Comes with One Year Free Upgrades



PAD II \$2995.99

SKU 737754
301180090

**ROBUST, DROP-TESTED, WATERPROOF
ANDROID-BASED FULL FUNCTION SCAN TOOL TABLET**

- 10.1" High-Res IPS Touch Screen with One-Click Wi-Fi Updates
- Domestic, European and Asian Coverage, Special Test Functions,
- Fast Live Data and Graphing and Module Coding Capabilities
- Quad-Core Processor with 32GB ROM/2GB RAM and Rechargeable Lithium-Ion Battery, 12,000 mAh, 6-8 Hours
- Full System Diagnosis is Through a Class-1 Bluetooth 2.1 Connector
- Includes MBZ 38-Pin and BMW 20-Pin Connectors
- Equipped with Both a Front and Rear Camera Supports Mini HDMI
- Video Out USB and Mini USB Port
- Optional Add-On Accessories: Battery Tester, Sensor Simulator, Four Channel Lab Scope and Video-Scope
- One Year Warranty & Comes with One Year Free Upgrades



GOLD CARCARE \$74.99

SKU 737755
301180151

**GOLD CARCARE TELEMATICS DEVICE
FOR OBDII COMPLIANT VEHICLES 96
AND NEWER**

- Android and iOS Compatible
- Works on All OBDII Compliant Vehicles 96 and Newer
- Transmits Live Data via Bluetooth Through a Car Owners Cell Phone (Android and iOS)
- Works in Conjunction with Launch Android Scan Tools
- Read and Clear Codes from Thousands of Miles Away!
- Map Search Functionality Allows Consumer to Search for Local Technicians or Shops



EASY DIAG 2.0 \$79.99

SKU 737769
301180136

TURN YOUR SMART DEVICE INTO A SCAN TOOL

- Android and iOS Compatible
- OBDII Generic Code Reader
- Reads and Clears Codes
- Includes Bluetooth OBDII Connector
- Add Any of Over 30 Asian, European and Domestic Manufacturers
- Single Carline Software Priced Individually Per Vehicle
- Additional Coverage, Capabilities and Functions with Each New Software Upgrade!



EASY DIAG 2.0 PLUS \$129.99

SKU 737758
301180138

TURN YOUR SMART DEVICE INTO A SCAN TOOL

- Includes 2 **FREE** Carlines of Your Choice
- Android and iOS Compatible
- View, graph & clear codes on all modules for your two selected carlines
- Includes Bluetooth OBDII Connector
- Add Additional Car Lines from Over 30 Asian, European and Domestic Manufacturers
- Additional Coverage, Capabilities and Functions with Each New Software Upgrade!



J-BOX 2 \$1699.99

SKU 119840
301020525

**THE LAUNCH J-BOX SETS J2534
STANDARDS FOR A PASS THROUGH DEVICE**

- New Design for Enhanced Capabilities
- Re-Flash Electronic Control Units (ECUs) to Repair Known Driveability and Emissions Issues
- Replace Software/Firmware with Updated OEM Software
- Simply Connect the J-Box to Your PC and Get the Most Out of Your OEM Application!



VIDEOSCOPE \$199.99

SKU 737766
307010003

**FLUID RESISTANT 7MM HEAD, LED ILLUMINATION
AND SIDE VIEW ANGLE MIRRORS**

- Compatible with PAD III
- View and Record Video in Full VGA Resolution
- 7 mm Camera (IP67 Certified)
- Side Angle Mirrors (35/45/60 Degrees)
- Four Adjustable LED Lights for Superior Brightness
- Lightweight, Ergonomic Design





Contact Us:
1-877-AZTool1 Phone
 (1-877-298-6651) *Hablamos Español*

Multimeters



Auto-Ranging Digital Multimeter

SKU 851885
 ESI480A **54⁹⁹**

- 43 Test Ranges, Auto-Ranging
- 10 Test Functions
- Auto Power-Off, Data Hold
- Dual Fuse Protection
- 10 Meg/Ohm Input Impedance



Deluxe Automotive Digital Multimeter with Carrying Case

SKU 301604
 ESI585K **119⁹⁹**

- Used for Diagnosing Electrical, Computer and Engine Problems
- 45 Test Ranges, 14 Test Functions, and Dual Fuse Protection
- RPM for DIS and Standard Ignitions
- RPM Pick-Up and Temperature Probe Included
- Dual Fuse Protection with Built-In Tilt Stand
- Dual Display with Analog Bar Graph and Digital Readings



Parasitic Drain Tester

SKU 011608
 LIS64970 **24⁹⁹**

- Replaceable In-Line Fuses
- Allows Tester and Meter to Remain Connected
- Stacking Banana Connectors

Relay Circuit Tester



SKU 383450
 27211 **139⁹⁹**

- Includes: Tester, (5) Popular Relay Leads, (1) Universal Relay Lead
- Use to Test Relay Circuits in Late Model Vehicles
- Can Also Be Used to Perform Easy Combination Tests, Fuel Pressure Tests and Jump Relay for A/C Fill
- Comes in a Blow Mold Case



Current Probe/Multimeter

SKU 489181
 ESI685 **199⁹⁹**

- 35 Test Ranges with Continuity BEEP
- 10 Test Functions with Overload Protection
- Heavy Duty Insulation Piercing Clips
- Automatically Powers Off
- Clamp Opening of 7/8"
- Carrying Case and 9 Volt Battery Included



Labscope



Dual Channel Lab Scope

SKU 94926
 UEIADL7103 **1,399⁹⁹**

- Digital Storage Oscilloscope
- Graphing Multimeter OBD2 Code Reader
- Sample Rate 25 Meg per Second
- 51 Preset Waveforms that Include Sensor, Actuator, Electrical and Ignition Patterns
- DC to 5Mhz Bandwidth
- Secondary Ignition Displays the Waveform
- Includes: Spark Voltage, RPM, Burn Time and Burn Voltage
- Parade Pattern On Secondary Ignition "Parade" Mode
- Built-In "Help" Includes Test Procedure
- Includes USB Software to Capture Screen Images



Timing Lights



Professional Timing Light

SKU 108154
 INN5568 **149⁹⁹**

- Four Function Digital Readout and Easy-to-Read Backlit LCD
- Tachometer: 249 to 9,990 RPM
- Advance Degrees (2 and 4 Cycle): 0° to 90°
- Dwell: 0° to 180°/ 2-12 Cylinders
- Voltage: 10 to 16 Volts DC
- Switches from 2 Cycle to 4 Cycle
- Heavy Duty ABS/Polycarbonate Shockproof Housing, Molded Boots, Built-In Hand Guard for Protection
- Detachable 6' Leads with Metal Inductive Pickup
- Patented Skip Circuitry Test Up to 9,990 RPM



Reprogrammer

CarDAQ-M®

SKU 222849
 DRWCARDAQ-M **1,899⁹⁹**

- High Performance J2534-1 Product for Reprogramming All Makes
- Technicians Can Use CarDAQ-M for Security Key Systems/Programming On Ford, GM and Toyota Vehicles
- Kit Includes a J2534-1 and J2534-2 Module, OBDII Cable, USB Cable, CD and User's Manual
- Ability to Add Extra CAN Channels, K-Line Channels, and Wireless Connectivity



Truly Universal Device, Educational Materials and Technical Support Included

CarDAQ-Plus J2534 Flash Reprogramming Kit

SKU 362551
 DRWCARDAQPLUS **1,680⁹⁹**

- Provides Both Ethernet and USB Connectivity to a PC
- Built-In Operating System for Running
- Internal Programs
- Protocol Support for Modern Vehicles
- 6 Analog Inputs
- Upgradeable Thru Firmware Updates and Expansion Slots
- ECU Programming (ECM, PCM, TCM, BCM, Etc.)
- Generic and OEM-Level Diagnostics
- Key Programming
- VIN Read/Write
- SKIM Clear/Reset
- Immobilizer Adaptation
- Data Monitoring



MongoosePro® Vehicle Interfaces

Chrysler

SKU 362554
 DRWMGSCI **499⁹⁹**

Ford

SKU 362553
 DRWMGFORD **499⁹⁹**

GM

SKU 362555
 DRWMGGM **499⁹⁹**

Toyota

SKU 362550
 DRWMGMFC **499⁹⁹**



- Designed to Be a Complete J2534 Tool for a Specific Car Manufacturer
- OEM Approved
- Supports Full Factory Diagnostics and Reprogramming
- Free Telephone and Email Support
- Optional Bluetooth Version



TVIT: Heavy Duty Interface

SKU 222850
 DRWTVIT **499⁹⁹**

- Premier Tool for In-Vehicle Communication Networks for Today's Modern Trucks
- TVIT Is a Universal HD Pass-Through Device that Works with HD OEM Applications for Diagnostics and Reprogramming
- Comes Complete with 6 and 9 Pin HD Connectors
- Works with Light Duty Trucks Too



Brake Lathes

Pro-Cut Brake Lathes Correct Rotor Distortion, Rotor Misalignment and Cure Brake Vibration

NEW

Pro-Cut 9.2DRO On Car Brake Lathe with 6 Adapter Package

SKU OUTSIDE BUY/EPO
 PCTPC92-6ADP **10,399⁹⁹**

- Includes: Pro-Cut 9.2 On-Car Brake Lathe, DRO Computer Box, Speed-Lock Cutting Head, Fixed Post Trolley, 6 Adapter Package, Accessory Kit, 6 Adapter Package (50-681, 50-687, 50-688, 50-693, 50-694, 50-946)
- The 6 Adapter Package Will Fit Import and Domestic 4 Lug Applications Up Through 1/2 Ton Trucks
- On-Site Installation and Training Provided



Available via Outside Buy/EPO, Call (1-877-298-6651) for details.

NEW

Pro-Cut A10-6 On Car Brake Lathe with 6 Adapter Package

SKU OUTSIDE BUY/EPO
 PCTPCA10-6ADP **12,999⁹⁹**

- Includes: A10 Warthog Lathe, 6 Adapter Package and Full Accessory Kit (50-681, 50-687, 50-688, 50-693, 50-694, 50-946)
- Heavy Duty PTO Drive System Provides Twice the Start Up Torque As Our Other Machines. Perfect for Fleet, Heavy Duty and High Car Demand!
- The 6 Adapter Package Will Fit Import and Domestic 4 Lug Applications Up Through 1/2 Ton Trucks
- On-Site Installation and Training Provided
- 2 Year Warranty



Available via Outside Buy/EPO, Call (1-877-298-6651) for details.

Call (1-877-298-6651) to Schedule and In Shop Demo.

BRAKE SERVICE

Brake Lathes

Model 4000SP Single Pass Brake Lathe

SKU 210247
AMM904000SP **5,999⁹⁹**

- Requires the Purchase of an Adapter Kit of Your Choice
- Single Speed Spindle and Feed Rates
- Cut Rotors in One Pass, with a High-Quality Finish

Lift Gate Service
SKU 262529 **55⁰⁰**
AMMLIFTGATE

Negative Rake (10 Pack)

SKU 262386 **24⁹⁹**
SHA06210



INCLUDES
Manufacturer's
Set-Up and Training
Purchase of Adapter Kit Required

Offer Good Through September 30, 2016 - While Supplies Last

AMMCO

BONUS

Brake Lathe Bench Kit
SKU 212739 | Part# AMM902500
and
Kit "B"
SKU 496629 | Part# AMM90002

VALUE: \$1,849.98

with Purchase of:
Model 4000SP Single Pass Brake Lathe
SKU 210247 | Part# AMM904000SP

Leasing Terms Available.
Ask Your AutoZone[®] Commercial Sales Manager.
Free Delivery!
in 48 Continental United States

Brake Lathe Bench

Brake Lathe Bench Kit

SKU 212739 **699⁹⁹**
AMM902500

- For All AMMCO Lathes
- Includes Sign, Toolboard, Funnel and Bucket



AMMCO

Model 4000B Brake Lathe

SKU 534380 **7,799⁹⁹**
AMM904000B

- Twin Cutter Tools and Quick Drum-to-Rotor Changeover
- Adjustable Spindle Speeds Allow for Quick Rough Cut/Finish Cut Settings
- Infinitely Adjustable Spindle Feed Gear Box
- User-Friendly Ergonomics
- Supports Drums or Rotors Up to 100 Lbs. Using the 1" Arbor, or Up to 200 Lbs. Using Optional 1-7/8" Arbor

Lift Gate Service
SKU 262529 **55⁰⁰**
AMMLIFTGATE

Negative Rake (10 Pack)

SKU 262386 **24⁹⁹**
SHA06210



INCLUDES
Manufacturer's
Set-Up and Training
Purchase of Adapter Kit Required

Offer Good Through September 30, 2016 - While Supplies Last

AMMCO

BONUS

Brake Lathe Bench Kit
SKU 212739 | Part# AMM902500
and
Kit "E"
SKU 496630 | Part# AMM90006

VALUE: \$2,474.98

with Purchase of:
Model 4000B Brake Lathe
SKU 534380 | Part# AMM904000B

Leasing Terms Available.
Ask Your AutoZone[®] Commercial Sales Manager.
Free Delivery!
in 48 Continental United States

Brake Lathe Adapter Kits

Kit "B"

SKU 496629 **1,149⁹⁹**
AMM90002

- Hub and Hubless Adapters for Vehicles Through 1/2 Ton

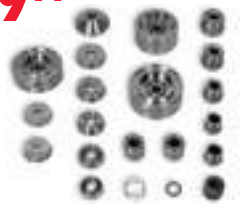

Kit "E"

SKU 496630 **1,774⁹⁹**
AMM90006

- Hub and Hubless Adapters for Most Vehicles Through 1 Ton
- Includes Double Chuck Kit and Tacoma Plate for Hubless Applications



AMMCO

Combination Brake Lathe RL8500

Complete Kit Includes Lathe, Adapters and Bench

SKU 901827 **5,649⁹⁹**
RANRL8500

Provides a FASTER MORE ACCURATE and EASIER Resurfacing Capability Than Any Other Brake Lathe in Its Class

- Infinitely Variable Speed Controller Able to Turn Rotors and Drums Faster Providing One-Cut, Micro-Finish Execution Every Time
- Maximum Rotor Diameter: 17"
- Maximum Rotor Thickness: 2-1/2"
- Brake Drum Diameter: 6" - 28"
- Maximum Load with Standard Arbor: 150 Lbs.
- Maximum Load with Truck Arbor: 150 Lbs.



(Shown with Optional Equipment, Accessories Not Included)



Truck Adapter Kit for RL8500 Brake Lathe

SKU 899411 **1,549⁹⁹**
RAN5150161

- Super-Duty Truck Tooling Package Consists of an Upgraded 1-7/8" Arbor and a Wide Variety of Adapters
- 36 Piece Set Allows Expanded Coverage to Handle Any Vehicle Through 1 Ton Trucks

Positive Rake Bits (10 Pack)
SKU 300786 **59⁹⁹**
SHA408-10



Lift Gate Service
SKU 262533 **135⁰⁰**
RANLIFTGATE

Leasing Terms Available.
Ask Your AutoZone[®] Commercial Sales Manager.
Free Delivery!
in 48 Continental United States

201 Combination Brake Lathe, Single-Speed

SKU 290004 **7,799⁹⁹**
HOF201TRUECUT

- Drive Motor: 1/2 HP (1,725 RPM)
- Arbor Speeds: 185 - 195 RPM Arbor Diameter (Standard): 1"
- Maximum Arbor Weight (Standard): 150 Lbs.
- Rotor/Flywheel/Drum Feed Rate per Revolution: 0.0025"
- Rotor/Flywheel Diameter Range: 5" - 18"
- Rotor/Flywheel Facing Travel: 4"
- Max Rotor Thickness: 3"
- Drum Diameter Range: 5" - 14"
- Drum Facing Width: 4"
- Power Requirements: 120V, 1Ph, 60HZ
- Includes Standard Adapters for Cars and Light-Trucks



(Shown with Optional Equipment, Bench and Board Sold Separately)

Accu-Turn Positive Rake Bits (10 Pack)

SKU 262383 **54⁹⁹**
SHA06010



Work Bench for 201 Brake Lathe

SKU 290008 **514⁹⁹**
HOFB206

Tool Board for 201 Brake Lathe

SKU 290006 **224⁹⁹**
HOFB203

Lift Gate Service
SKU 290017 **95⁰⁰**
HOFLIFTGATE



Silencer Bands

1-3/4" Drum Silencer Band

SKU 262390 **29⁹⁹**
SHA80B



AMMCO Style Large Disc Band with Lead Weights

SKU 262397 **39⁹⁹**
SHA930



2-3/4" Large Truck Drum Silencer Band

SKU 262391 **49⁹⁹**
SHAA5290



Large Solid Rotor Silencer Band (9")

SKU 262396 **14⁹⁹**
SHA94



Large Solid Rotor Silencer Band (6")

SKU 262393 **14⁹⁹**
SHA96



AMMCO Style Disc Silencer Band with Lead Weights

SKU 262392 **29⁹⁹**
SHA69



Silencer Clamp

SKU 388821 **39⁹⁹**
SHA70B

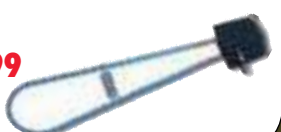

SHARK USA

Carbide Lathe Inserts



SKU	PART#	DESCRIPTION	APPLICATION	PRICE	SKU	PART#	DESCRIPTION	APPLICATION	PRICE
262385	SHA0626	Negative Rake (6 Pack) • Models 3860, 4000, 4100 and 7000	Ammco	17⁹⁹	543384	SHA069-10	Positive Rake (10 Pack)	Pro-Cut	49⁹⁹
262387	SHA1042	Positive Rake (2 Pack) • Model 3850	Ammco	17⁹⁹	262382	SHA40710	Carbide Inserts (10 Pack)	FMC	49⁹⁹
262386	SHA06210	Negative Rake (10 Pack)	Ammco	24⁹⁹	262409	SHA80210	Carbide Inserts (10 Pack)	Kwik Way	59⁹⁹
262389	SHA06810	Positive Rake (10 Pack) • Model BL500 and 501	Hunter	29⁹⁹	300786	SHA408-10	Positive Rake (10 Pack)	FMC/Ranger	59⁹⁹
262388	SHA1046	Carbide Inserts (6 Pack)	Ammco	34⁹⁹	262383	SHA06010	Carbide Inserts (10 Pack)	Accuturn	54⁹⁹

SHARK USA



Contact Us:
1-877-AZTool1 Phone
 (1-877-298-6651) *Hablamos Español*

Bleeders

V-12 Economy Professional Reverse Brake and Clutch Bleeder

SKU 289898
PH02003 **189⁹⁹**

- Bleed the Brakes On Any Vehicle in 10 Minutes or Less, Including ABS Save Time and Money On Good Parts Not Properly Bled One Man Operation



MaxProHD Reverse Brake and Clutch Bleeder

SKU 289896
PH02002 **399⁹⁹**

- Bleeds Brakes or Clutches in Half the Time
- Includes a Full Set of Adapters for Vacuum, Pressure, Pulse Generation, Bench and Cross Bleeding Methods



Brake Bleeding Tools

One Man Brake Bleeding Kit

SKU 070116
25136 **34⁹⁹**

- Easily Diagnose Vacuum and Pressure Related Systems from the EGR to Brake Bleeding to Cooling Systems On Today's Complex Vehicles
- Kit Contains Our Most Popular Hand Vacuum Pump with Vacuum Gauge and Accessories



Vacuum Brake Bleeder

SKU 526506
24440 **59⁹⁹**

- Works with Your Air Compressor to Quickly Bleed Clutches and Brakes On Most Cars and Trucks
- Includes Fill Bottle and Master Cylinder Adapter Set



Silverline Elite Test Kit

SKU 988888
MITMV8500 **94⁹⁹**

- Provides Either Vacuum or Pressure with Equal Precision and Convenience
- Performs Engine Performance Diagnostics, Brake Bleeding, Fluid Transfer, Evacuation, Sampling and More
- Includes Components Needed to Perform Hundreds of Diagnostic and Mechanical Tests



Universal Fluid Dispensing Bottle

SKU 568477
24443 **39⁹⁹**

- Refill the Master Cylinder During Vacuum or Manual Hydraulic Brake or Clutch Bleeding and Flushing
- Mounts Securely to Master Cylinder and Clamps
- Capacity: 50 Oz.



Brake Bleeding Kit

SKU 604208
MITMV6830 **189⁹⁹**

- Compressed Air Operation
- 1.9 Quart Capacity
- Swivel Air Inlet with Quick Disconnect



BONUS Refill Kit
 SKU 972280 | Part#: MITMVA6832
VALUE: \$64.99 with Purchase of:
Brake Bleeding Kit
 SKU 604208 | Part#: MITMV6830
 Offer Good Through September 30, 2016 -
 While Supplies Last



Brake Fluid Testers

Brake Fluid Tester DOT 3, DOT 4, DOT 5.1

SKU 850067
25269 **34⁹⁹**

- Easily, Quickly and Precisely Check the Water Content of 8 Types of Polyglycol-Based Brake Fluids (DOT 3, DOT 4, DOT 5.1, ACDelco DOT 3, Pennzoil, Prestone, Motorcraft and Toyota DOT 3)



NEW

Brake Fluid Tester

SKU 191687
25267 **29⁹⁹**

- Calibrated for DOT 4 Fluid
- Small Size and Easy-to-Use Compared to Single Use Strips
- Not for Use with DOT 5 Fluid



Brake Strip Brake Fluid Copper Test Kit

SKU 289905
PH03006 **79⁹⁹**

- Everything Needed to Test Brake Fluid - Know within 60 Seconds if it's Time for a Change
- Includes: (1) Tube of 100 Strips; (100) Color Rating Cards



Phoenix Sytems 8002-B Coolant and Brake Test Strips

SKU 850029
PH08002-B **94⁹⁹**

- 100 Double Ended Test Strips that Can Be Used to Quickly and Accurately Determine When to Correct or Replace Engine Coolant and Brake Fluid



Sprayers

Red Powder Coated Aluminum Sprayer

SKU 186463
MSMB8000PL **44⁹⁹**

- 16 Oz. Capacity
- Not for Use with Chlorinated Solvents



Red Powder Coated Steel Sprayer

SKU 186459
MSMA1000R **69⁹⁹**

- 32 Oz. Capacity
- Not for Use with Water-Based Products



Complete Repair Kit for B8000PL

SKU 186467
MSMBK50 **19⁹⁹**



Filler Cap Assembly

SKU 186466
MSMP156 **19⁹⁹**

- Hand Removable
- For Model "A" Sprayers



Complete Repair Kit for Model "A" Sprayers

SKU 186465
MSMK10 **29⁹⁹**

- Includes All Parts that Can Be Replaced
- All Chemical Resistant Seals
- Used for Model A1000R and A2000 32 Oz. Sprayers



Hones and Stones

Adjustable Brake Cylinder Hone

SKU 531780
25032 **14⁹⁹**

- Range: 1/2" to 2-1/4" (13 mm to 57 mm)



Brake Cylinder Hone 3/4" to 2-1/2"

SKU 047928
25028 **18⁹⁹**

- Range: 3/4" to 2-1/2" (19 mm to 64 mm)



Replacement Stone Sets

SKU 046789
2528M **5⁹⁹**

- 2 Medium Grit (#220)



Flex-Hone Kit BC Kit D 180SC

SKU 341378
BRMBCKD **79⁹⁹**

- BC Kit D (18 mm, 20 mm, 22 mm, 25 mm, 29 mm)



Brake Service Tools

Brake Caliper Brush

SKU 250125
25435 **5⁹⁹**

- Slim Design for Cleaning Brake Calipers and Other Brake Hardware



2 Piece Hose Pinchers

SKU 191675
25250 **19⁹⁹**

- A Quick, Easy Way to Pinch-Off Vacuum Lines, Fuel Lines, Etc. without Damaging the Line



Brake Cylinder Retainer Remover

SKU 265111
25268 **19⁹⁹**

- Use On GM X and J Body Cars
- Expands and Holds Special Retainer So the Brake Cylinder May Be Removed



8 Piece Manual Brake Gauge Set

SKU 191672
25266 **19⁹⁹**

- Color Coded Brake Gauge Identifies Thickness Levels for Brake Lining Inspection



Spring Brake Tool for GM

SKU 222526
LIS50600 **34⁹⁹**

- Releases Tension On Both Large and Small GM Single Spring Brakes During Servicing



8 Piece Brake Tool Set

SKU 900827
27194 **49⁹⁹**

- Includes: Spring Compressor, Brake Spring Installer, Spring Removal Tool, Brake Retaining Spring Tool, Brake Spring Pliers, Two Brake Adjustment Spoons and Mini Adjustment Spoon



SAVE \$5

3/8" Pro Impact Driver

SKU 452628
24213 **19⁹⁹** REG. \$24.99

- Handle Design Reduces Risk of Hitting Hand
- 3/8" Drive and 5/16" Hex for Phillips and Flat Bits
- Includes: 8 Screwdriver Bits

Offer Good Through September 30, 2016
While Supplies Last



Disc Brake Tools

Speedy Pad Spreader

SKU 291417
LIS24300 **42⁹⁹**

- Compresses Disc Brake Pistons in Seconds
- Makes Brake Pad Replacement Easier



Quick Quad Pad Spreader

SKU 080553
LIS29100 **79⁹⁹**

- A Quick Way to Spread Brake Pads and Compress Disc Brake Pistons for Pad Replacement On Single, Double and Quad Piston Calipers
- Simultaneously Compress all Four Pistons On Quad Piston Applications
- Can Be Used While Caliper Is On the Vehicle or Hanging Free



Dual Speedy Pad Spreader

SKU 291420
LIS25750 **49⁹⁹**

- Compresses Dual Brake Pistons Simultaneously
- Makes Dual Piston Pad Replacement a Simple Job



18 Piece Disc Brake Caliper Set

SKU 094798
27113 **74⁹⁹**

- Caliper Adapters from 1-3/16" to 2-1/2", Some Specifically to Service Nissan, SAAB and Honda Models
- Caliper Rotation Tool with Left Hand Threads for Ford Applications



Dual Piston Press

SKU 900811
25741 **29⁹⁹**

- Used to Press in Dual Brake and Single Pistons

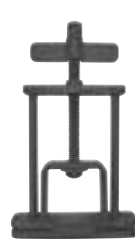

Rotor Flex-Hone

49⁹⁹ each

- Lowers Harmonic Vibrations
- Ideal for New and Re-Turned Rotors and Flywheels

Fine

SKU 341310
BRMRMFH240Z25

Medium

SKU 341298
BRMRMFH120Z25

Coarse

SKU 341314
BRMRMFH60Z25



AIR COMPRESSORS

2 Stage Compressors 30 Gallon

13 HP Horizontal with Honda Engine

SKU 110435
IRT2475F13GH **2,699⁹⁹**

- Gas Powered Honda Engine
- CFM: 25 @ 175 PSI
- Cast Iron Pump

DELIVERY INCLUDED

IN STOCK
Ready To Ship

Start-Up Kit

SKU 970499 **134⁹⁹**
IRT32312936

- Includes: (2) Air Filter Elements, (2) Quarts 4 Cycle Engine Oil, (4) Liters of All Season Synthetic Lube
- Using this Kit Extends Compressor Pump Warranty to 2 Years



Lift Gate Service
SKU 262532 **80⁰⁰**
IRTLIFTGATE

13 HP Horizontal with Honda Engine

SKU 110306
OEMTUK13030HGE **2,099⁹⁹**

- Gas Powered Honda Engine
- CFM: 22 @ 175 PSI
- Cast Iron Pump

PLUS:

- Synthetic Oil

BEST VALUE

OEM TOOLS
HONDA



OEM Tank Color May Vary Depending on Stock

Lift Gate Service
SKU 295540 **80⁰⁰**
OEMLIFTGATE

DELIVERY INCLUDED

IN STOCK
Ready To Ship

13 HP Horizontal with Honda Engine

SKU 344741
CPTTCP1330G **2,549⁹⁹**

- 175 Max PSI
- CFM: 25.3 @ 100 PSI
- Premium Cast Iron and Aluminum Hybrid Pump
- 12V Electric and Recoil Starter Standard
- EZ Pull Type Tank Drain
- Oil Monitor
- Cold Start Valve
- Full 2 Year Warranty

DELIVERY INCLUDED

Lift Gate Service
SKU 361260 **75⁰⁰**
CPTLIFTGATE

Chicago Pneumatic
HONDA



2 Stage Compressors 60 Gallon

5 HP Vertical Air Compressor

SKU 210433
IRT2340L5 **1,449⁹⁹**

- CFM: 14.7 @ 175 PSI
- Cast Iron Pump
- Volts: 230 Single Phase
- Factory Mounted and Wired Motor Starter



DELIVERY INCLUDED
IN STOCK
Ready To Ship

Start Up Kit

SKU 970496 **134⁹⁹**
IRT32305880

- (4) Quarts Synthetic Lube and (2) Air Filters
- Use of Kit Extends Compressor Pump Warranty to 2 Years

Lift Gate Service
SKU 262532 **80⁰⁰**
IRTLIFTGATE

5 HP Vertical Air Compressor with Magnetic Starter

SKU 110299
OEMTE5060VM **1,099⁹⁹**

- CFM: 15 @ 150 PSI
- Cast Iron Pump
- Volts: 230 Single Phase
- Factory Mounted and Wired Motor Starter
- Easy Access Drains

PLUS:

- Vibration Damper Pads
- Synthetic Oil

DELIVERY INCLUDED

Lift Gate Service
SKU 295540 **80⁰⁰**
OEMLIFTGATE

BEST VALUE

OEM TOOLS



OEM Tank Color May Vary Depending on Stock

IN STOCK
Ready To Ship

5 HP Reciprocating Air Compressor

SKU 344627
CPTTCP561VNS **1,099⁹⁹**

- 165 Max PSI
- Volts: 208 - 230 PSI
- Premium Cast Iron and Aluminum Hybrid Pump
- Volts: 208 - 230 Single Phase
- Magnetic Starter: Not Required
- Full 2 Year Warranty

DELIVERY INCLUDED

Lift Gate Service
SKU 361260 **75⁰⁰**
CPTLIFTGATE

Chicago Pneumatic



2 Stage Compressors 80 Gallon

5 HP Vertical Air Compressor

SKU 095102
IRT2475N5V **2,349⁹⁹**

- Cast Iron Pump
- CFM: 16.8 @ 175 PSI
- Factory Mounted and Wired Motor Starter
- Volts: 230 Single Phase



DELIVERY INCLUDED

5 HP Premium Vertical Air Compressor

SKU 040598
IRT2475N5-P **2,499⁹⁹**

- Features of the Non-Premium Model Plus
- Electronic Automatic Tank Drain
- Aircooled Aftercooler
- Low Oil Level Protection Switch

7.5 HP Vertical Air Compressor

SKU 210434
IRT2475N7.5 **2,399⁹⁹**

- CFM: 24.0 @ 175 PSI
- Cast Iron Pump
- Factory Mounted and Wired Motor Starter
- Volts: 230 Single Phase



7.5 HP Premium Vertical Air Compressor

SKU 040597
IRT2475N7.5P **2,599⁹⁹**

- Features of the Non-Premium Model Plus
- Electronic Automatic Tank Drain
- Aircooled Aftercooler
- Low Oil Level Protection Switch

Start-Up Kit

SKU 970496 **134⁹⁹**
IRT32305880

- (4) Quarts Synthetic Lube and (2) Air Filters
- Use of Kit Extends Compressor Pump Warranty to 2 Years

Lift Gate Service
SKU 262532 **80⁰⁰**
IRTLIFTGATE

IN STOCK
Ready To Ship

5 HP Vertical Air Compressor

SKU 110300
OEMTN5080VM **1,599⁹⁹**

- Cast Iron Pump
- CFM: 16.5 @ 175 PSI
- Volts: 230 Single Phase
- Factory Mounted and Wired Motor Starter
- Easy Access Drains

PLUS:

- Vibration Damper Pads
- Low Oil Shut-Off
- Synthetic Oil

DELIVERY INCLUDED

Lift Gate Service
SKU 295540 **80⁰⁰**
OEMLIFTGATE

BEST VALUE

OEM TOOLS



OEM Tank Color May Vary Depending on Stock

IN STOCK
Ready To Ship

5 HP Vertical Air Compressor

SKU 012631
CPTTCP-381VS **1,749⁹⁹**

- 175 Max PSI
- CFM: 18.5 @ 100 PSI
- Volts: 208 - 230 Single Phase
- Premium Cast Iron and Aluminum Hybrid Pump
- Mag Starter Included
- Solid Cast Iron Cylinders
- High Performance Inter-Cooler and After-Cooler
- Comes Ready to Run, No Start-Up Kit Required

5 HP Premium Vertical Air Compressor

SKU 344629
CPTTCP581V **2,249⁹⁹**

- Premium Model Includes: Low Oil Level Switch, Auto Tank Drain, Triple Pass Pump Mounted Aftercooler

Lift Gate Service
SKU 361260 **75⁰⁰**
CPTLIFTGATE

Chicago Pneumatic



7.5 HP Vertical Air Compressor

SKU 012624
CPTTCP-7581VS **2,099⁹⁹**

- 175 Max PSI
- CFM: 25.3 @ 100 PSI
- Volts: 208 - 230 Single Phase
- Premium Cast Iron and Aluminum Hybrid Pump
- Mag Starter Included
- Solid Cast Iron Cylinders
- High Performance Inter-Cooler and After-Cooler
- Comes Ready to Run, No Start-Up Kit Required

7.5 HP Two Stage Premium Model

SKU 344631
CPTTCP-7581V **2,349⁹⁹**

- Premium Model Includes: Low Oil Level Switch, Auto Tank Drain, Triple Pass pump Mounted Aftercooler



2 Stage Compressors 120 Gallon

10 HP Horizontal Air Compressor

SKU 210437
IRT2545E10 **2,799⁹⁹**

- CFM: 35 @ 175 PSI
- Cast Iron Pump
- Volts: 230 Three Phase
- Factory Mounted and Wired Motor Starter



IN STOCK
Ready To Ship

10 HP Premium Horizontal Air Compressor

SKU 040549
IRT2545E10-P **3,849⁹⁹**

- Features of the Non-Premium Model Plus
- Electronic Automatic Tank Drain
- Aircooled Aftercooler
- Low Oil Level Protection Switch

Start-Up Kit

SKU 970497 **164⁹⁹**
IRT32305898

- (4) Quarts Synthetic Lube and (2) Air Filters
- Use of Kit Extends Compressor Pump Warranty to 2 Years

Lift Gate Service
SKU 262532 **80⁰⁰**
IRTLIFTGATE

IN STOCK
Ready To Ship

10 HP Horizontal Air Compressor Three Phase

SKU 110305
OEMTUK100120M3 **2,599⁹⁹**

- CFM: 32.5 @ 175 PSI
- Cast Iron Pump
- Volts: 230 Three Phase
- Factory Mounted and Wired Motor Starter

10 HP Horizontal Air Compressor Single Phase

SKU 110303
OEMTUK100120M1 **2,999⁹⁹**

Lift Gate Service
SKU 295540 **80⁰⁰**
OEMLIFTGATE

OEM TOOLS

- PLUS:
- Low Oil Shut-Off
 - Synthetic Oil
 - Auto Drain

IN STOCK
Ready To Ship

DELIVERY INCLUDED



OEM Tank Color May Vary Depending on Stock

10 HP Horizontal Air Compressor

SKU 012626
CPTC10123HS **2,749⁹⁹**

- CFM: 35 @ 100 PSI
- Volts: 208 - 230 Three Phase
- Mag Starter Included
- Premium 800 RPM Cast Iron Pump
- Concentric Disc Valves
- Cast Iron Inter-Cooler and After-Cooler
- Full 2 Year Warranty
- 175 Max PSI

10 HP Vertical Air Compressor

SKU 012634
CPTC10123VS **3,049⁹⁹**

Lift Gate Service
SKU 361260 **75⁰⁰**
CPTLIFTGATE

Chicago Pneumatic



NEW



IN STOCK
Ready To Ship

Free Delivery!
in 48 Continental United States

Specifications Subject to Change Without Notice or Liability.
Prices Do Not Include Vehicles, Installation or Optional Equipment as Shown.

Customers Responsible for Off-Loading Equipment Upon Arrival.
Ask Your Sales Rep for Details.

Leasing Terms Available!
Ask Your AutoZone® Commercial Sales Manager.

Leasing Terms Available!†

Ask Your AutoZone®
Commercial Sales Manager

AutoZone
Tool & Equipment QUARTERLY

How to Size Your Air Compressor

Determine Compressor Type:

- Single Tech Shop or Low Volume Usage: Single-Stage (90-125 PSI)
- Two or More Tech Shop or High Volume Usage: 2 Stage (125-175 PSI)

Determine Air Consumption. Conduct a Shop Audit on Air Requirements or Use These Benchmarks:

- 5 CFM per Person in General Repair Shop
- 8 CFM per Person in HD Truck Shop
- 12 CFM per Person in Paint and Body Shop

Make Adjustments to Above Total CFM Requirements to Compensate for Compressor Duty Cycle

- Multiply by 1.5 for Single Stage
- Multiply by 1.25 for 2 Stage
- Add 10% to Total for Air Leaks and Future Growth in Business

Chose a Compressor that Best Fits the Required CFM per PSI Rating

COMMON AIR TOOL CFM CONSUMPTION

AIR TOOL	CFM
Air Hammer	4.0
Body Polisher	2.0
Body Orbital Sander	5.0
Die Grinder	5.0
Drill, 1/16" to 3/8"	4.0
Grease Gun	3.0
Hydraulic Floor Jack	6.0

AIR TOOL	CFM
Impact Wrench 3/8"	2.0
Impact Wrench 1/2"=	3.5
Impact Wrench 3/4"	7.5
Impact Wrench, 1"	10
Medium Duty Sander	40.0
Spring Oiler	4.0
Touch-Up Paint Spray Gun	3.5

Gas Compressor

5.5 HP, 30 Gallon Horizontal with Honda Engine

SKU 110298
OEMPUK5530G **999⁹⁹**
• Gas Powered Honda Engine
• CFM: 12.0 @ 90 PSI
• ASME Certified



OEM TOOLS
HONDA

IN STOCK
Ready To Ship

8 HP, 30 Gallon Horizontal with Honda Engine

SKU 979920
OEMTUE8030HGE **1,799⁹⁹**
• Electric Start
• CFM: 16 @ 175 PSI
• Cast Iron Pump
• Synthetic Oil



Single Stage Compressors

Single Stage, 6 HP* 60 Gallon Vertical Compressor

SKU 110297
OEMPK7060VS **999⁹⁹**
• 3 Cylinder Cast Iron Pump
• 19.5 CFM @ 90 PSI
• Max. PSI: 150
• 230 Volt/Single Phase
*3 HP/6 HP Peak

IN STOCK
Ready To Ship



Lift Gate Service
SKU 295540
OEMLIFTGATE **80⁰⁰**

PLUS:
• Vibration Damper Pads, Synthetic Oil, Easy Tank Drain

OEM Tank Color May Vary Depending on Stock

Single Stage, 5 HP*, 20 Gallon Vertical Compressor

SKU 110315
PUMPK5020VP **529⁹⁹**
• CFM: 7.1 @ 40 PSI
• CFM: 5.5 @ 90 PSI
• 120/240 Volt / Single Phase
*2 HP/5 HP Peak



Single Stage 6 HP*, 60 Gallon Vertical Compressor

SKU 436011
PUMPK6060V **599⁹⁹**
• 2 Cylinder Cast Iron Pump
• 12 CFM @ 90 PSI
• Max PSI: 150
• 230 Volt Single Phase
*3 HP/6 HP Peak



Compressor Oil SAE30 (1 Qt)
SKU 301791
PUM074-SAE30 **19⁹⁹**

Compressor Synthetic Oil (1 Qt)
SKU 301795
PUM074-SYN30 **29⁹⁹**

Compressor/Generator/Welder

Compressor/Generator/Welder

SKU 410033
MTMAGWSR143M **4,674⁹⁹**
• Quality Cast Iron Two Stage Compressor
• Electric Start Option Included
• Battery and Cables Not Included
• Generator Output: 4,500 Watts Continuous
• Welder: 150A @ 100% Duty Cycle (50 - 170A Working Range)
• CFM: 15.7 @ 175 PSI (Equipped with 150 PSI Maximum Rated Regulator)



CARB Compliant

Regulators/Filters/Drains

Digital Air Regulator

SKU 978113
25862 **29⁹⁹**
• Ensures Accurate and Consistent Air Pressure for Spray Guns and Other Air Operating Tools



Regulator with Gauge (1/4")

SKU 543086
ARRR262G **24⁹⁹**
• Adjustment Range Is 5-125 PSIG
• Rated for 25 SCFM



In-Line Air Tool Filter (1/4")

SKU 543067
ARR9132 **14⁹⁹**
• Protect Your Air Tools
• Max Pressure: 500 PSI
• Length: 1-9/16"



Disposable In-Line Desiccant Filter Dryer (1/4")

SKU 543077
ARRDFD-10 **19⁹⁹**
• Maximum Flow Capacity: 15 CFM
• Maximum Pressure: 125 PSI
• See-Through Housing Shows Desiccant Color Change, Indicates that the Dryer Needs to Be Replaced



Particulate Filter (1/2")

SKU 543079
ARRF354 **34⁹⁹**
• 40 Micron
• 100 CFM
• 150 PSI



Description	SKU	Part #	Price
Particulate Filter (3/8")	543078	ARRF353	34.99

Air Regulator with Gauge (1/2")

SKU 543091
ARRR354G **44⁹⁹**
• Adjustment Range Is 5-125 PSIG
• Rated for 100 SCFM



Description	SKU	Part #	Price
Regulator with Gauge (3/8")	543088	ARRR353G	49.99

Automatic Lubricator (1/2")

SKU 543085
ARRL354 **59⁹⁹**
• Lubricator May Be Filled without Shutting Down Air Line
• 3 Position Adjustment Knob



Description	SKU	Part #	Price
Automatic Lubricator (3/8")	543083	ARRL353	59.99

Electronic Drain (1/2")

SKU 543065
ARR5804 **69⁹⁹**
• Automatically Drains Compressor Tanks, Receiver Tanks or Filters
• 110 Volt
• 6' Power Cord



Coalescing Filter Oil Removing Filter (1/2")

SKU 543081
ARRF554AW **69⁹⁹**
• .003 Micron Filter Element
• 37 CFM
• Manual Drain



Description	SKU	Part #	Price
Coalescing Oil Removing Filter (3/8")	543080	ARRF553AW	69.99

Integral Filter/Regulator with Gauge (1/2")

SKU 543071
ARRB754G **69⁹⁹**
• Operating Pressure Range 5-125 PSI
• 40 Micron Element
• 3 Position Non-Rising Adjustment Knob



Description	SKU	Part #	Price
Integral Filter/Regulator w/ Gauge (1/4")	543069	ARRB752G	69.99
Integral Filter/Regulator w/ Gauge (3/8")	543070	ARRB753G	69.99

Filter Regulator Lubricator w/Gauge Modular Combo (1/2")

SKU 543075
ARRC33354 **199⁹⁹**
Extend the Life of Your Air Tools!
• Cleans, Dries and Lubricates Air Supply
• Operating Pressure Range 5-125 PSI
• 40 Micron Element
• 142 CFM



Description	SKU	Part #	Price
Filter Regulator Lubricator w/ Gauge Modular Combo (1/4")	543072	ARRC33352	199.99
Filter Regulator Lubricator w/ Gauge Modular Combo (3/8")	543073	ARRC33353	199.99

5 Stage Desiccant Filter/Dryer

SKU 543076
ARRC7612XL **419⁹⁹**
• Includes Gauge, Shut-Off Valve and One Gallon of Desiccant
• Lowers the Dew Point to -30° F



Description	SKU	Part #	Price
Replacement Desiccant Silica Gel, 1 Quart	543068	ARR34189	14.99

Free Delivery!
in 48 Continental United States

Specifications Subject to Change Without Notice or Liability.
Prices Do Not Include Vehicles, Installation or Optional Equipment as Shown.

Customers Responsible for Off-Loading Equipment Upon Arrival.
Ask Your Sales Rep for Details.

Leasing Terms Available.†
Ask Your AutoZone® Commercial Sales Manager.

AIR TOOLS

BONUS

11 Piece, 1/2" Drive Deep Impact Socket Set (SAE) and 10 Piece, 1/2" Drive Deep Impact Socket Set (Metric)

SKU 391196 | Part# 25594 (SAE) + SKU 391194 | Part# 25592 (Metric)

VALUE: \$109.98



with Purchase of:
1/2" Drive Composite Impact Wrench
SKU 347258 | Part# 24400

1/2" Drive Composite Impact Wrench

SKU 347258 24400 **299⁹⁹**

- Max. Torque: 900 Ft/Lbs.
- Air Consumption: 5.1 CFM
- Air Inlet Thread: 3/8"
- Weight: 4.58 Lbs.
- Noise Power: 96.2 db.A



Offer Good Through September 30, 2016 - While Supplies Last

1/2" Impact

OEM TOOLS

Stubby 1/2" Drive Impact Wrench

SKU 626146 24403 **149⁹⁹**

- Max. Torque: 450 Ft/Lbs. Reverse
- Small but Powerful
- Lightweight: 3.5 Lbs.
- 3 Torque Adjustments

Air Consumption
4.7 CFM



Every Day Low Price

1/2" Composite Impact Wrench

SKU 900832 25775 **149⁹⁹**

- Max. Torque: 500 Ft/Lbs.
- CFM: 3.9

Air Consumption
3.9 CFM



1/2" Impact Wrenches

1/2" Impact Wrench

SKU 884521 25821 **59⁹⁹**



- Torque: 400 Ft/Lbs.
- 6,500 RPM Forward

1/2" Impact Wrench

SKU 900831 25774 **89⁹⁹**



- Torque: 400 Ft/Lbs.
- 5.6 CFM Air Consumption

1/2" Impact Wrench

SKU 466599 25769 **89⁹⁹**



- Torque: 425 Ft/Lbs.
- 4 CFM Air Consumption

3/4" Impact Wrenches

OEM TOOLS

3/4" Heavy Duty Impact Wrench

SKU 466617 25810 **279⁹⁹**

- Torque: 1,300 Ft/Lbs.
- 6.6 CFM Air Consumption
- 4,400 RPM Free Speed



IR Ingersoll Rand

3/4" Impact Wrench

SKU 970473 IRT261 **569⁹⁹**

- Jumbo Hammer Mechanism
- Torque: 1,100 Ft/Lbs.



1/2" Impact Wrench Classic

SKU 495316 IRT231C **144⁹⁹**



- Torque: 600 Ft/Lbs.
- Pressure-Feed Lubrication
- Adjustable Power Regulator
- 1/2" Square Drive

1/2" Impact Wrench

SKU 970487 IRT231HA **199⁹⁹**



- Pressure Fed Lubrication System
- Handle Exhaust Direct Away from User
- Standard of the Industry for 3 Decades
- Sound Pressure: 94 - 105

1/2" Super Air Impact Wrench with 2" Extended Anvil

SKU 604744 IRT231HA2 **229⁹⁹**



- Torque: 590 Ft/Lbs.

1/2" Quiet Impact Wrench

SKU 738489 IRT2135QXPA **289⁹⁹**



- Light, Quiet and Powerful Impact
- Twin Hammer Mechanism
- Weighs Only 4 Lbs.
- Torque: 780 Ft/Lbs.

1/2" Street Legal "Thundergun" Impact Wrench

SKU 495318 IRT232TGSL **319⁹⁹**

- Torque: 625 Ft/Lbs.
- 10,000 RPM for Lightning Fast Removal Is Best-in-Class



10,000 RPM

1/2" Titanium Impact Wrench

SKU 695134 IRT2325TIMAX **329⁹⁹**

- 1,350 Ft/Lbs. of Torque
- 930 Ft/Lbs. of Reverse Torque
- Twin Hammer Impact Mechanism
- Lightweight



3/8" Impact Wrenches

OEM TOOLS

Mighty Compact 3/8" Drive Impact Wrench

SKU 802213 24411 **149⁹⁹**

- Lightweight and Compact, Only Weighs 3.5 Lbs.
- Fits in One Hand (5-1/4" in Length)
- Air Consumption: 4.7 CFM
- Free Speed: 11,000 RPM
- Working Torque: 280 Ft/Lbs.
- Maximum Torque: 320 Ft/Lbs. Reverse
- Clutch Type: Twin Hammer



3/8" Impact Wrench

SKU 970486 IRT212 **199⁹⁹**

- Most Powerful 3/8" Pistol Grip Impact
- Torque: 180 Ft/Lbs.
- Single Hammer Design



3/8" Titanium Air Impact Wrench

SKU 198065 IRT2115TIMAX **349⁹⁹**

- Torque: 300 Ft/Lbs.
- Feather Touch Trigger and Patented Push Button Forward/Reverse



1" Impact Wrenches

OEM TOOLS

1" Super Duty Impact with Extended Anvil

SKU 466618 25811 **379⁹⁹**

- Torque: 1,600 Ft/Lbs.
- 4,000 RPM Free Speed



1" Impact Wrench with Extended Anvil

SKU 970474 IRT285B6 **669⁹⁹**

- 6" Anvil for Better Truck Wheel Nut Accessibility
- 1,770 Ft/Lbs. of Reverse Torque
- Hi-Efficiency Motor



Reversible Drills

3/8" Reversible Air Drill

SKU 466595 25765 **89⁹⁹**

- 90 PSI
- 4 CFM Air Consumption
- 2,200 RPM Free Speed
- 35 In/Lbs. Max Torque
- Sound Level: 91 Decibels
- Weight: 2-1/2 Lbs.



3/8" Reversible Air Drill

SKU 970482 IRTIR7802RA **199⁹⁹**

- Variable Speed Throttle
- Reversible Motor with a Quick Reverse Lever
- 2,000 RPM Free Speed
- Lightweight, Compact



1/2" Reversible Air Drill

SKU 970483 IRTIR7803RA **289⁹⁹**

- 500 RPM Free Speed
- Auxiliary Side Handle
- Heavy Duty 1/2" Industrial Grade Chuck



Air Hammers

OEM TOOLS

Heavy Duty Air Hammer

SKU 900833 25776 **79⁹⁹**

- 2,200 Impacts per Minute
- Recommended Air Pressure: 90 PSI
- Air Consumption: 6.3 CFM
- Air Inlet Thread Size: 1/4" NPT



Accessories Included

SAVE \$15

1/4" Mini Angle Air Die Grinder

SKU 802214
24407 **49⁹⁹** REG. \$64.99

- Recommended Air Pressure: 90 PSI
- Air Consumption: 2.8 CFM
- Free Speed: 18,000 RPM
- Air Inlet Thread Size: 1/4" NPT
- Angle: 90 Degrees



Composite Body

Offer Good Through September 30, 2016 - While Supplies Last

SAVE \$10

1/4" Mini Angle Die Grinder and Surface Prep Kit

SKU 094648
25777 **49⁹⁹** REG. \$59.99

- Right Angle Design for Tight Places
- Weights Only 1.1 Lbs.
- Grinding and Cleaning All-in-One Kit
- 20,000 RPM for Clean Precise Work
- 4 CFM Air Usage Works with Small Compressors

- Adjustable Air Throttle for Control to Fit the Job
- Air Inlet Strainer
- Angle Head Grease Fitting
- Includes: (10) Grinding Stones in 1/4" and 1/8" Shank Sizes; 1/4" and 1/8" Collet; (4) 2" and (4) 3" Cleaning Discs Stripping; 2" and 3" Backing Pads; 2 Piece Hand Wrench and 2 Piece Disc Holder (1/4")



Offer Good Through September 30, 2016 While Supplies Last

OEM TOOLS



Air Sanders and Polishers

OEM TOOLS

High Speed Air Sander*

SKU 466594
25764 **39⁹⁹**

- 90 PSI
- 4.5 CFM Air Consumption
- 14,00 RPM Free Speed
- Sound Level: 88 Decibels
- Weight: 2-1/2 Lbs.



*While Supplies Last

OEM TOOLS

Dual Action Air Sander

SKU 011577
33625830 **49⁹⁹**

- Air Consumption: 4.0 CFM
- Free Speed: 10,000 RPM
- Pad Size: 6"
- Recommended Air Pressure: 90 PSI
- Recommended Hose Size: 3/8"
- Weight: 3.87 Lbs.



OEM TOOLS

2" Surface Prep Tool

SKU 094650
25778 **49⁹⁹**

- 4 Position Air Volume Control
- RPM: 20,000
- CFM: 3
- Quick Change "Twist Lock" Mandrel



All Twist Lock Accessories Work with this Sander

BONUS

12 Piece, 3/8" Drive Shallow Impact Socket Sets

SKU 391191 | Part# 25589 (SAE) + SKU 391190 | Part# 25587 (Metric)

VALUE: \$48.98



with Purchase of:
3/8" Drive Reactionless Air Ratchet
SKU 347259 | Part# 24401

3/8" Drive Reactionless Air Ratchet

SKU 347259
24401 **179⁹⁹**

- Maximum Torque: 75 Ft/Lbs.
- Air Inlet: 1/4" NPT
- Free Speed: 450 RPM
- Air Consumption: 2.52 CFM
- Ratchet Pawl: Single
- Exhaust: Rear

Impact Mechanism Adds Power and Prevents Kickback



Offer Good Through September 30, 2016 While Supplies Last

IR Ingersoll Rand



6" Dual Action Sander

SKU 970475
IRTIR311A **79⁹⁹**

- Dual Action Pad Motion Reduces Swirl
- Built-In Silencer for Quiet Operation

IR Ingersoll Rand



Straight Line Sander

SKU 970479
IRTIR315 **149⁹⁹**

- Twin Piston Design for Smooth Operation
- 3,000 Strokes per Minute
- Quick-Action Paper Clamps

IR Ingersoll Rand



Orbital Sander

SKU 970476
IRTIR312A **169⁹⁹**

- 8,000 RPM Free Speed
- One Hand Operation
- Contoured Palm Grip

IR Ingersoll Rand



Heavy Duty Angle Sander

SKU 970477
IRTIR313A **249⁹⁹**

- 5,000 RPM Free Speed
- Lightweight, Only 4-1/2 Lbs.
- Ball Bearing Construction for Long Life

Heavy Duty Buffer Polisher

SKU 970478
IRTIR314A **269⁹⁹**

- Hi-Speed Range: 1,500-2,500 RPM
- 7" Backing Pad
- Handles the Toughest Polishing and Buffing Jobs



5" High Speed Air Sander

SKU 688297
80-365 **39⁹⁹**

- Free Speed: 18,000 RPM
- Designed for Light Sanding, Feathering, Edging and Rust Removal



Duralast

1/4" Air Ratchets

OEM TOOLS

1/4" Industrial Air Ratchet

SKU 466593
25763 **49⁹⁹**

- Delivers 25 Ft/Lbs. of Torque and 265 RPM Free Speed



1/4" Drive Super Duty Air Impact Ratchet

SKU 850508
24415 **179⁹⁹**

- Max Torque: 50 Ft/Lbs.
- Free Speed: 700 RPM
- CFM: 3.1 @ 90 PSI
- Length: 6.5"
- Sealed Head Ratchet Housing Prolongs Tool Life
- Compact and Lightweight
- Most Power to Weight Ratio
- Rear Air Exhaust: 360° Adjustable

Best Power to Weight Ratio in Its Class



700 RPM

Impact Mechanism Adds Power and Prevents Kickback

1/4" Stubby

SKU 970472
IRT105D2 **129⁹⁹**

- Delivers 25 Ft/Lbs. of Torque and 250 RPM Free Speed



IR Ingersoll Rand

Die Grinders

OEM TOOLS

Air Tire Buffer

SKU 802218
24410 **89⁹⁹**

- Recommended Air Pressure: 90 PSI
- Air Consumption: 3.5 CFM
- Free Speed: 2,600 RPM
- Air Inlet Thread Size: 1/4" NPT
- Minimum Hose Size: 3/8"



1/4" Compact Air Die Grinder

SKU 802211
24405 **47⁹⁹**

- Recommended Air Pressure: 90 PSI
- Air Consumption: 3.4 CFM
- Free Speed: 25,000 RPM
- Air Inlet Thread Size: 1/4" NPT



1/4" Air Die Grinder

SKU 802212
24406 **49⁹⁹**

- Recommended Air Pressure: 90 PSI
- Air Consumption: 3.4 CFM
- Free Speed: 22,000 RPM
- Air Inlet Thread Size: 1/4" NPT



1/4" Extended Air Die Grinder

SKU 802216
24408 **64⁹⁹**

- Recommended Air Pressure: 90 PSI
- Air Consumption: 2.5 CFM
- Free Speed: 23,000 RPM
- Air Inlet Thread Size: 1/4" NPT



Composite Body

3" Mini Die Grinder

SKU 466591
25761 **44⁹⁹**

- 4 CFM Air Consumption
- 25,000 RPM Free Speed
- Recommended Air Pressure: 90 PSI
- Recommended Hose Size: 3/8"
- Air Inlet Thread Size: 1/4" NPT



1/4" Mini Air Die Grinder

SKU 751631
24404 **49⁹⁹**

- Ultra Compact Size Fits into Spaces Regular Die Grinders Cannot
- Requires Only 2.4 CFM @ 90 PSI for Optimum Performance
- Free Speed: 25,000 RPM
- Lightweight: 0.7 Lbs
- Collet Size: 1/4"



Mini Angle Die Grinder

SKU 466592
25762 **79⁹⁹**

- 6 CFM Air Consumption
- 25,000 RPM Free Speed
- Recommended Air Pressure: 90 PSI
- Recommended Hose Size: 3/8"
- Air Inlet Thread Size: 1/4" NPT



3/8" Air Ratchets

OEM TOOLS

3/8" Pro Air Ratchet

SKU 210212
25819 **49⁹⁹**

- Max Torque: 60 Ft/Lbs.
- Free Speed: 160 RPM
- Recommended Air Pressure: 90 PSI



3/8" Drive Super-Duty Air Impact Ratchet

SKU 850055
24416 **179⁹⁹**

- Max Torque: 50 Ft/Lbs.
- Free Speed: 700 RPM
- CFM: 3.1 @ 90 PSI



700 RPM

Impact Mechanism Adds Power and Prevents Kickback

3/8" Air Ratchet

SKU 970485
IRTIR107XPA **119⁹⁹**

- Advanced Head Design
- Features 54 Ft/Lbs. of Torque
- 360° Adjustable Exhaust



IR Ingersoll Rand

3/8" Super-Duty Air Ratchet

SKU 495290
IRT109XPA **199⁹⁹**

- Torque: 76 Ft/Lbs.
- Variable Speed Button Trigger
- 360° Adjustable Exhaust



IR Ingersoll Rand

AIR HOSES AND REELS

VIPERFLEX™

• Heavy Duty Polymer Hose Material Redefines Flexibility. Stays Flexible Under All Weather Conditions (-40° to 150° F)

- Holds No Memory. Kink Resistant Under Pressure
- 300 PSI Working Pressure
- Bend Restriction for Reducing Wear and Tear and Extending Life of Hose
- Solid Brass MNPT Ends



Whip Hoses

1/4" NPT End Fittings

ViperFlex™ 3/8" x 4' Swivel Whip Hose

SKU 347219 **15⁹⁹**
24420

3/8" NPT End Fittings

ViperFlex™ 1/2" x 4' Swivel Whip Hose

SKU 347221 **17⁹⁹**
24421



3/8" Hoses

1/4" NPT End Fittings

ViperFlex™ 3/8" x 25' Air Hose

SKU 347222 **19⁹⁹**
24422

ViperFlex™ 3/8" x 50' Air Hose

SKU 347223 **25⁹⁹**
24423

ViperFlex™ 3/8" x 100' Air Hose

SKU 347225 **49⁹⁹**
24425



1/2" Hoses

1/2" NPT End Fittings

ViperFlex™ 1/2" x 25' Air Hose

SKU 347226 **24⁹⁹**
24426

ViperFlex™ 1/2" x 50' Air Hose

SKU 347227 **39⁹⁹**
24427

ViperFlex™ 1/2" x 100' Air Hose

SKU 347228 **74⁹⁹**
24428

Accessories



3/8" x 25' Red Rubber Air Hose, 1/4" NPT Male Ends

SKU 978117 **29⁹⁹**
24905

- 250 PSI Working Pressure

3/8" x 50' Red Rubber Air Hose, 1/4" NPT Male Ends

SKU 978112 **34⁹⁹**
24906

- 250 PSI Working Pressure

1/2" x 50' Red Rubber Air Hose, 1/2" NPT Male Ends

SKU 978116 **59⁹⁹**
24908

- 250 PSI Working Pressure



3/8" x 5' x 1/4" NPT Swivel End Whip Hose

SKU 186489 **24⁹⁹**
IRTWH385

- 1-1/4" x 1/4" NPT Ends
- Operates Up to 200 PSI
- Burst Pressure: 800 PSI
- OSHA Yellow for Safe Visibility
- Temperature Range: -20 to 150 Degrees



100' Manual Steel Hose Reel

SKU 291343 **32⁹⁹**
25970

- Hand Crank with Spring-Loaded Axle
- Mount Horizontally or Vertically



ViperFlex™ 3/8" x 50' Retractable Hose Reel

SKU 347224 **99⁹⁹**
24424

- Hose Reel Made with Impact Resistant Plastic and Heavy Duty Spring Action
- Retractable Hose Reel Lock Allows You to Lock the Hose in Any Position
- New Spring Action Design Tested Up to 5,000 Times
- 1/4" Solid Brass NPT Inlet

Polymer Hose Never Kinks!

VIPERFLEX™



* Hose Included

3/8" x 50' Air Hose Reel

SKU 900815 **99⁹⁹**
25979

- Smooth Automatic Retracting Spring Coil
- 50 Ft. Hose
- 3/8" NPT Fittings
- Max. Pressure: 250 PSI



OEM TOOLS

3/8" x 50' Value Series Air Hose Reel

SKU 972284 **184⁹⁹**
LIN83753

1/2" x 50' Value Series Air Hose Reel

SKU 972285 **199⁹⁹**
LIN83754

- Retractable Delivery Hose
- Durable Heavy Gauge Steel Construction
- Slotted Mounting Base for Easy Installation



LINCOLN

Dual Support, Spring Rewind Hose Reel with 50' Air Hose

SKU 901689 **249⁹⁹**
RANRH50PL

- Use for Air or Water
- 50' / 300 PSI Hose
- Fittings: 3/8 NPT



Ranger

Piping Systems



RapidAir Compressed Air Piping System 1/2" Master Kit

SKU 360485 **139⁹⁹**
RAP90500

- Designed to Easily Install Beneath Walls of New Construction or On Wall Surfaces of Existing Workshops
- Allows Compressed Air Lines Exactly Where You Want them, Just Like Electrical Outlets
- Includes: (2) Air Outlet Kits, (1) Compressor Manifold Kit, 100' Nylon Tubing and Tubing Cutter



100 Ft. RapidAir Tubing Kit
SKU 360549 **49⁹⁹**
RAP20100

1/2" RapidAir Outlet Kit
SKU 360542 **32⁹⁹**
RAP90100

Compressor Manifold Kit
SKU 360548 **34⁹⁹**
RAP90200

MaxLine Compressed Air Piping System 3/4" Master Kit

SKU 360593 **249⁹⁹**
RAPM7500

- Heavier Duty Components for Longer Air Runs in Larger Buildings
- (3) Air Outlets, (1) 3/4" NPT Straight Fitting, (2) Tees, (20) Clips
- 100' of 3/4" HDPE Tubing



300 Ft. 3/4" MaxLine Tubing Kit
SKU 360650 **369⁹⁹**
RAPM6031

100 Ft. 3/4" MaxLine Tubing Kit
SKU 360649 **139⁹⁹**
RAPM6030

3/4" MaxLine Outlet Kit
SKU 360629 **29⁹⁹**
RAPM7510

Aluminum Core: Holds Any Bent Shape!

3/4" Union Fitting
SKU 360656 **19⁹⁹**
RAPM8022



Inflators

OEM TOOLS

Air Chuck with Comfort Grip Handle

SKU 802200 **17⁹⁹**
24414

- Durable, OEM Screwdriver Style Handle for Comfort and a Positive Grip
- Sealed-Ball Air Chuck Is Extended 1" from Handle to Allow Access to Tight Areas



Dual Foot Air Chuck with Comfort Grip Handle

SKU 802201 **19⁹⁹**
24413

- Comfortable Screwdriver Style Handle
- 30° Reverse Angle Chuck Can Be Used On Outside Tires
- Tilt Lock Feature Locks Onto the Valve



OEM TOOLS

Dual-Head Chuck Tire Inflator Gauge

SKU 094652 **24⁹⁹**
25864

- 6" Chrome-Plated Dual-Head Chuck with Full 360° Swivel Action with 15' Air Hose
- Capacity: 10 to 120 Lbs.
- Gauge Reads in 2 Lbs. Increments



OEM TOOLS

Digital Tire Inflator

SKU 802198 **59⁹⁹**
24412

- Easy-to-Read Backlit LCD Display
- Four Units of Measure (PSI, Bar, kPa, kgf)
- Measuring Range: 0 - 12 Bar (0 - 175 PSI)
- Accuracy: +/-1.2 PSI Up to 58 PSI, +/-2.3 Between 58 PSI and 145 PSI Inclusive, +/-3.6 PSI Greater Than 145 PSI
- High Air Flow Saves the Technician Time



SHOP SUPPLY of the MONTH
SEPTEMBER
SEE INSERT FOR DETAILS

SAVE \$5

OEM TOOLS

Tire Inflator

SKU 301772 **59⁹⁹**
24380

- Clear and Easy-to-Read 80 mm 180 PSI Gauge
- 3-in-1 Function: Inflate, Deflate and Measure Tire Pressure
- Increased Accuracy to Improve Tire Performance and Prevent TPMS Comebacks



OEM TOOLS

Inflator Gauge, Dual-Head Straight Foot for Inner Duals

SKU 301603 **59⁹⁹**
MILS516

- 15" Hose
- 10 - 120 PSI Dual Foot Straight Chuck Ideal for Dual Wheel Equipped Vehicles
- Heavy Duty Construction Provides for Long Life Even Under Extreme Use and Conditions
- Gauge and Valve Cartridges Are Replaceable
- Equipped with Magnifying Lens for Full View of Scale



MILTON INDUSTRIAL INC.

AIR TOOL ACCESSORIES

Cut-Off Accessories

1" Cut-Off Wheel Mandrel and Screws (2 Pack)

SKU 094907
SHA32 **19⁹⁹**



3" x 1/16" Cut-Off Wheels (25 Pack)

SKU 347215
25839B **24⁹⁹**

- Spindle 3/8"
- 25,000 RPM



Cut-Off Wheels (25 Pack)

SKU 094906
SHA25-25 **44⁹⁹**

- 3" x 1/16" x 3/8"



Impact Sockets



12 Piece, 3/8" Drive Shallow Impact Socket Sets

SKU 391191
25589 (SAE) **26⁹⁹** SKU 391190
25587 (Metric) **21⁹⁹**

- Shallow 6 Point High Quality Impact Sockets
- SAE: 5/16", 3/8", 7/16", 1/2", 9/16", 5/8", 11/16", 3/4", 13/16", 7/8", 15/16" and 1"
- Metric: 8, 9, 10, 11, 12, 13, 14, 15, 16, 17, 18 and 19 mm



12 Piece, 3/8" Drive Deep Impact Socket Sets

SKU 442193
25590 (SAE) **46⁹⁹** SKU 464314
25588 (Metric) **38⁹⁹**

- Deep 6 Point High Quality Impact Sockets
- SAE: 5/16", 3/8", 7/16", 1/2", 9/16", 5/8", 11/16", 3/4", 13/16", 7/8", 15/16" and 1"
- Metric: 8, 9, 10, 11, 12, 13, 14, 15, 16, 17, 18 and 19 mm

35 mm, 1" Drive Budd Wheel Socket

SKU 466566
25525 **25⁹⁹**

33 mm, 1" Drive Budd Wheel Socket

SKU 466569
25528 **24⁹⁹**

1-1/2" Hex x 13/16" Square Deep 1" Drive Budd Wheel Socket

SKU 466570
25529 **29⁹⁹**

- For Budd Wheel 1-1/2" with 13/16" Inside Hex



Impact Star

10 Piece External Star Socket Set

SKU 191054
25954 **19⁹⁹**

- Includes: 3/8" - 1/2" Drive Star: E5, E6, E7, E8, E10, E12, E14, E16, E18 and E20
- Features Chrome Moly Steel Components for Strength and Durability
- Comes On a Convenient Storage Clip



Impact Extensions

1/2" to 3/8" Drive Reducing Extension Adapters

SKU 110292
25240 **59⁹⁹**

- 3 Piece Set Includes Sizes: 12", 24" and 36"
- This Specialty Extension Set Lets You Use Your 1/2" Drive Tools with 3/8" Sockets
- Get into Tight Spots Like Those Around a Transmission Bell Housing



1/2" Impact Grade Extension Set

SKU 914182
70-391 **19⁹⁹**

- Includes Sizes: 6" and 10"
- Chrome Moly Steel for Strength
- Black Oxide Finish to Resist Rust
- Ball Socket Retention



Cut Off Tools

Heavy Duty Reciprocating Air Saw

SKU 802225
24409 **89⁹⁹**

- Recommended Air Pressure: 90 PSI
- Air Consumption: 1.7 CFM
- Enhanced Blade Guard Design and Trigger Safety Lock
- 9,000 Strokes per Minute



Heavy Duty Air Nibbler

SKU 970480
IRTIR325B **189⁹⁹**

- Cuts Quarter Panels with No Distortion
- Starts Cuts in the Center of a Panel
- Holds 1/4" Radius Accurately



Air Reciprocating Saw

SKU 970481
IRTIR429 **119⁹⁹**

- Designed for Cutting Intricate Shapes
- Cuts Flat and Curved Surfaces
- Comes with (6) High Speed Steel Cutting Blades



Heavy Duty Air Shear

SKU 970484
IRTIR7802SA **209⁹⁹**

- Shear that Cuts Squares, Angles and Circles
- Cuts Up to 20 Gauge without Chips



SAVE \$5

OEM TOOLS

2" Surface Prep Discs (25 Pack) Twist-Lock Style

SKU 125687
24941 **24⁹⁹** REG. \$29.99

- 2" Coarse Grit / 25 Pack

SKU 125690
24940 **24⁹⁹** REG. \$29.99

- 2" Medium Grit / 25 Pack

Offer Good Through September 30, 2016 While Supplies Last

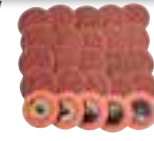

SAVE \$10

OEM TOOLS

3" Surface Prep Discs (25 Pack) Twist-Lock Style

SKU 125691
24942 **31⁹⁹** REG. \$41.99

- 3" Coarse Grit / 25 Pack

SKU 125692
24943 **31⁹⁹** REG. \$41.99

- 3" Medium Grit / 25 Pack

Offer Good Through September 30, 2016 While Supplies Last



Surface Prep

2" Surface Disc Assortment Twist-Lock Style

SKU 094920
SHA620TBA **39⁹⁹**

- Includes: (12) Coarse, (10) Medium, (3) Fine and (1) 2" Holder



Twist-Lock Disc Holders

SKU 094911
SHA323T2 **24⁹⁹**

- 2" Holder / 2 Pack

SKU 094916
SHA333T2 **29⁹⁹**

- 3" Holder / 2 Pack

SKU 094912
SHA323TB **24⁹⁹**

- 2" and 3" Holder Set

Thermostat Gasket Residue Remover

SKU 291346
LIS22500 **25⁹⁹**

- Floating Guide Shaft to Steer Abrasive Pad Around the Gasket Surface
- Use with a Die Grinder to Quickly Clean Off the Gasket Surface



2" Zirconia Mini Grinding Discs Twist-Lock Style

SKU 094908
SHA3220ZGT **39⁹⁹**

- 2" / 24 Grit / 25 Pack

SKU 094909
SHA3230ZGT **39⁹⁹**

- 2" / 36 Grit / 25 Pack

SKU 094915
SHA3250ZGT **39⁹⁹**

- 2" / 50 Grit / 25 Pack



Impact Adapters

5 Piece Impact Grade Adapter Set

SKU 914056
70-383 **22⁹⁹** STORE STOCK

- Made of Chrome Moly Steel for Strength
- Storage Rail
- Includes Sizes: 1/4" to 3/8", 3/8" to 1/2", 1/2" to 3/4", 3/8" to 1/4" and 1/2" to 3/8"



5 Piece Adapter and Universal Joint Set (3/8" and 1/2" Drive)

SKU 965864
24226 **29⁹⁹**

- Made of Chrome Moly Steel for Strength
- Includes: 3/8" Drive Universal Joint, 3/8" Dr. (F) x 1/2" (M) Adapter, 1/2" Drive Universal Joint, 1/2" Drive (F) x 3/8" (M) Adapter and 1/2" Drive (F) x 3/4" (M) Adapter



Impact Star

10 Piece External Star Socket Set

SKU 191054
25954 **19⁹⁹**

- Includes: 3/8" - 1/2" Drive Star: E5, E6, E7, E8, E10, E12, E14, E16, E18 and E20
- Features Chrome Moly Steel Components for Strength and Durability
- Comes On a Convenient Storage Clip



Impact Extensions

1/2" to 3/8" Drive Reducing Extension Adapters

SKU 110292
25240 **59⁹⁹**

- 3 Piece Set Includes Sizes: 12", 24" and 36"
- This Specialty Extension Set Lets You Use Your 1/2" Drive Tools with 3/8" Sockets
- Get into Tight Spots Like Those Around a Transmission Bell Housing



1/2" Impact Grade Extension Set

SKU 914182
70-391 **19⁹⁹**

- Includes Sizes: 6" and 10"
- Chrome Moly Steel for Strength
- Black Oxide Finish to Resist Rust
- Ball Socket Retention



Couplers/Plugs

HI-Flo V-Style 1/4" MNPT Steel Plug, 10 Pack SKU 480772 MILS7601-5 **24⁹⁹**

HI-Flo V-Style 3/8" MNPT Steel Plug, 10 Pack SKU 480775 MILS7621-5 **29⁹⁹**

HI-Flo A,M,V-Style 1/4" FNPT Coupler, 2 Pack SKU 480783 MILS764-2 **24⁹⁹**

HI-Flo A,M,V-Style 3/8" FNPT Coupler, 2 Pack SKU 480784 MILS766-2 **24⁹⁹**

Improves Performance of High Air Consumption Air Tools.

1/2" Female Coupler G-Style, Each SKU 481703 MILS1815 **22⁹⁹**

1/2" Male Coupler G-Style, Each SKU 481696 MILS1816 **22⁹⁹**

1/2" Male Plug G-Style, 5 Pack SKU 480770 MILS1817-5 **29⁹⁹**

1/2" Female Plug G-Style, 5 Pack SKU 480771 MILS1818-5 **34⁹⁹**

1/4" Universal, No Scratch, Composite Body Quick Coupler

SKU 099186
24241 **15⁹⁹**

- Lightweight, Durable Nylon Composite Body
- 1/2" x 18 NPT; Female



1/4" Air Swivel Connectors

SKU 099162
24242 **19⁹⁹**

- 360° Swivel Action at 2 Points for Maximum Maneuverability
- 1/4" NPT
- Maximum Air Pressure: 150 PSI



AIR TOOLS AND ACCESSORIES

NEW ITEMS

Digital Tire Inflator

SKU 543041 19357 **89⁹⁹**

- Easy to read backlit LCD display
- 90 Second auto-off function
- Four units of measure: p.s.i., bar, kPa, & kgF
- 20" swivel hose
- Inflation range: 0-174 psi
- Inlet thread: 1/4" Female BSP



360 Degree Swivel Connector

SKU 543140 19444 **6⁹⁹**

- STORE STOCK**
- Swivels 360° in both directions
 - Reduces stress at hose connection points
 - Works with 1/4" NPT fittings & quick connect adapters



3-Way Quick Connect Female Coupler

SKU 543306 19461 **5⁹⁹**

- STORE STOCK**
- Quick connect design allows for quick assembly and release of air tools
 - AMT 3-Way Style accepts the 3 most popular 1/4" nipple styles:
 - A Style: ARO 210 style
 - M Style: Milton or Industrial Style
 - T Style: Tru-Flate/Parker Automotive Style



5pc High Flow Quick Connect Coupler & Plug Set

SKU 543355 19460 **11⁹⁹**

- STORE STOCK**
- H/F High Flow couplers and plugs are machined with larger inside diameters, doubling the amount of air flow to your tool
 - Great for applications requiring high volumes of air: abrasive blast cabinets, HVLP spray guns, cut-off tools, die grinders, & other high CFM air tools



2-Way Swivel Splitter

SKU 543231 19445 **17⁹⁹**

- STORE STOCK**
- Fits A, M, and T style fittings
 - Splits (1) 1/4" air line into (2) 1/4" outputs
 - Allows connection of (2) tools to a single outlet
 - 360° Swivel feature reduces kinks in hose



Vaper Air Tools

Siphon Feed Spray Gun

SKU 976511 19418 **54⁹⁹**

- STORE STOCK**
- Fully Adjustable Spray Pattern
 - 1.8 mm Needle and Nozzle Set for Heavier Materials
 - Non Bleeder Type, Siphon Feed
 - Spun Aluminum 1 Liter Canister



1.4 mm Gravity Feed HVLP Spray Gun

SKU 976510 19014 **54⁹⁹**

- STORE STOCK**
- Lightweight Plastic Paint Cup
 - Stainless Steel Needle and Nozzle Set Resists Corrosions and Wear from Abrasive Materials
 - Air Valve for Precise Air Flow Adjustment
 - Includes Pressure Regulator and Cleaning Kit



Dual Setup Spray Gun Kit

SKU 976507 19800 **99⁹⁹**

- STORE STOCK**
- 1.4 mm Set for Lighter Materials
 - 1.7 mm Set for Heavier Materials
 - Locking Pressure Regulator with Gauge
 - Operating Pressure: 15 - 45 PSI



1/2" Drive Air Impact Wrench

SKU 976504 19748 **54⁹⁹**

- STORE STOCK**
- Ideal for Removing/Installing Nuts and Bolts, Tire Changing, General Assembly and Other Workshop Applications
 - Die Cast Aluminum Body with Rubber Scuff Guards
 - Built-in Air Regulator Varies Speed and Power
 - 230 Ft/Lbs. Maximum Torque



Air Die Grinder

SKU 977046 19747 **24⁹⁹**

- STORE STOCK**
- Ideal for Light Duty Metal Fabrication, Grinding, Porting and Polishing Applications
 - Durable, Lightweight Composite Housing Design Helps Reduce Vibration
 - Lever Lock Throttle for Safety
 - 1/4" Collet



3" Air Cut-Off Tool

SKU 976505 19746 **39⁹⁹**

- STORE STOCK**
- Ideal for Cutting Sheet Metals, Fiberglass, Bolts, Muffler Clamps, Etc
 - 18,000 RPM No Load Speed
 - Includes 3" Abrasive Wheel
 - Includes Arbor Wrench and Allen Wrench



3/8" Drive Air Ratchet

SKU 976509 19749 **49⁹⁹**

- STORE STOCK**
- Durable, Lightweight Composite Housing
 - Forward/Reverse Lever Conveniently Located for Quick Direction Changes
 - Front Exhaust Blows Debris Away from Work Area
 - 45 Ft/Lbs. Max Torque



Air Hammer

SKU 976508 19750 **24⁹⁹**

- STORE STOCK**
- Ideal for General Cutting, Chipping and Scraping
 - Hardened Steel Barrel and Piston
 - Die Cast Aluminum Body with Rubber Scuff Guards
 - Includes (1) Spring Retainer and (4) Most Popular Chisels



4 Piece Air Chisel Set

SKU 977873 19355 **5⁹⁹**

- STORE STOCK**
- Assortment of the Most Popular Chisels
 - 4-3/4" Overall Length
 - Bushing Splitter, Weld Buster, Ripping Chisel and Tapered Punch



3" x 1/16" Cut-Off Wheel

SKU 977872 19336 **3⁹⁹**

STORE STOCK

- Spindle 3/8"
- 25,000 RPM



5 Piece Grinding Wheel Set

SKU 977880 19352 **2⁹⁹**

STORE STOCK

- 25,000 RPM Rated



1/4" x 25' Recoil Hose

SKU 977897 19368 **12⁹⁹**

- STORE STOCK**
- 1/4" NPT (M)
 - Swivel Ends



50' PVC Air Hose

SKU 977899 19371 **22⁹⁹**

- STORE STOCK**
- Premium Grade Hose with Bend Restrictors at Each End for Prolonged Life
 - Working Pressure: 300 PSI
 - Burst Pressure: 1,200 PSI
 - Resists Gasoline, Oil and Other Automotive Liquids



50' Rubber Air Hose

SKU 359693 19382 **34⁹⁹**

- STORE STOCK**
- Working Pressure: 300 PSI
 - Burst Pressure: 1,200 PSI
 - 3/8" Brass Fittings
 - Vinyl Kink Restrictors



(2) 3/8" Hose Splicers

SKU 977888 19345 **2⁹⁹**

STORE STOCK



(2) 3/8" Hose Ends

SKU 980359 19346 **2⁹⁹**

STORE STOCK

- 1/4" NPT



Piston Style Blow Gun

SKU 977886 19360 **6⁹⁹**

- STORE STOCK**
- Air Inlet 1/4" NPT
 - Fiberglass Reinforced Nylon Body for Strength
 - OSHA Compliant Tip



Blow Gun with Removable Venturi Tip

SKU 807628 19402 **12⁹⁹**

- STORE STOCK**
- Venturi Tip Allows for 4X the Air Flow
 - Lightweight and Durable
 - 1/4" NPT
 - Working Pressure: 90 - 120 PSI



Blow Gun with Rubber Tip

SKU 976307 19435 **6⁹⁹**

- STORE STOCK**
- 1/4" (6.3 mm) NPT (F)



17 Piece Accessory Kit

SKU 977877 19338 **17⁹⁹**

- STORE STOCK**
- 1/4" NPT (F)
 - Kit Includes: Safety Lever Blow Gun, Blow Gun Inflators, Pressure Gauge, Dual Tire Chuck, Coupler, (2) Male Connectors, Female Connector, (2) Female Couplers and (4) Male Couplers



Air Adjusting Valve with Gauge

SKU 978090 19359 **7⁹⁹**

- STORE STOCK**
- 0 to 140 PSI
 - 1/4" NPT
 - Male and Female Fittings



Air Adjusting Valve with Gauge

SKU 977895 19303 **17⁹⁹**

- STORE STOCK**
- 1/4" NPT



Spot Sprayer

SKU 333347 19419 **34⁹⁹**

- Designed to Spray Fluids Such As Alcohol, Solvents and Cleaners
- 80 - 150 PSI Operating Pressure
- Refillable Metal Construction
- Eliminates Harmful Propellants
- 32 Oz. Capacity



2 Piece Disposable Filters

SKU 977871 19302 **7⁹⁹**

- STORE STOCK**
- Helps Reduce Painting Defects
 - Removes Moisture, Oil Vapor and Rust Particles that Pass Through Conventional Filters



Thread Seal Tape

SKU 807362 19320 **1⁹⁹**

- STORE STOCK**
- Use On Air Line Connections to Prevent Leaks
 - 1/2" x 260"



Dual Foot Inflator and Gauge

SKU 977878 19341 **17⁹⁹**

- STORE STOCK**
- 1/4" NPT (F)

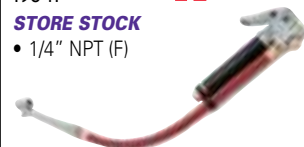

Quick Connect Set

SKU 977885 19330 **4⁹⁹**

- STORE STOCK**
- 1/4" NPT Female
 - 1/4" NPT Male
 - Interchangeable with Milton - "M" Style and Amflo - Type



Swivel Plug

SKU 480787 19327 **4⁹⁹**

- STORE STOCK**
- 1/4" (6.3mm) NPT (M)
 - 30° Swivel Action Reduces Fatigue By Increasing Mobility at the Tool
 - Swivel Feature for Easy Access in Confined Spaces





Contact Us:
1-877-AZTool1 Phone
 (1-877-298-6651) *Hablamos Español*

SAVE OVER \$1,520

Edge 501 Aligner with 412A 12,000 LB. Alignment Lift Combo

SKU **OUTSIDE BUY/EPO** **16,399⁹⁹**
 ALIGNCOMB06

- The Edge 501 Aligner Includes: Wireless Sensors, Deluxe Software, Brake Pedal Depressor, Self Centering Wheel Clamps and Steering Wheel Lock
- The 412A Lift Features Include: Turntables with Cover Plates, 2 Rolling Jacks, Airline Kit, Auto Shut Off, Air Operated Lock Release



Price Does Not Include Installation or Optional Equipment as Shown.

ALIGNERCOMB06		\$16,399.99
ATEATEDGE-501-4PT	Edge 501 Aligner System	\$9,995.00
ATEATPK-412A	12,000 Lbs. Alignment Lift	\$5,795.00
ATEATPK-RJ6BK-AH-KIT (2)	6,000 Lbs. Rolling Bridge Jack	\$2,130.00
TOTALS		\$17,920.00
SAVINGS		\$1,520.01

Available via Outside Buy/EPO, Call (1-877-298-6651) for details.

Lift Gate Service
 SKU 290017
 HOFLIFTGATE **95⁰⁰**

SAVE OVER \$1,680

Edge 601 Pro Aligner with 414A 14,000 LB. Alignment Lift Combo

SKU **OUTSIDE BUY/EPO** **20,999⁹⁹**
 ALIGNCOMB07

- The Edge 601 Aligner Includes: Wireless Sensors, Premium Software, Brake Pedal Depressor, FastClamp 3 Point Wheel Clamps and Steering Wheel Lock
- The 414A Lift Features Include: Turntables with Cover Plates, 2 Rolling Jacks, Airline Kit, Auto Shut Off, Air Operated Lock Release



Available via Outside Buy/EPO, Call (1-877-298-6651) for details.

Lift Gate Service
 SKU 290017
 HOFLIFTGATE **95⁰⁰**

ALIGNERCOMB07		\$20,999.99
ATEATEDGE-601-PRO	Edge 601 Aligner System	\$13,995.00
ATEATPK-414A	14,000 Lbs. Alignment Lift	\$6,495.00
ATEATPK-RJ7BKNP-AH-K (2)	7,000 Lbs. Rolling Bridge Jack	\$2,190.00
TOTALS		\$22,680.00
SAVINGS		\$1,680.01

Lift Equipment

3 Ton Capacity Jack Stands

SKU **079399** **39⁹⁹**
 KT161202

- Lifting Range: 11.6" to 16.75"
- Designed to be Used in Pairs
- Steel Base with 4 Feet Pads for Stability
- Ratchet Action Design with Ductile Iron Support Column
- Complies with ASME PALD/2009 Safety Standards



700 Lb. Engine Support Bar

SKU **079529** **89⁹⁹**
 KT162114

- Transverse Support Bar Adjusts from 34.5" to 61"
- Designed to Support Front Wheel Drive Engines for Repair or Motor Mount Replacement
- Includes Support Leg for Heavier Engines
- Engine Attachment and Adjustment Hardware Provided
- Complies with ASME PALD/2009 Safety Standards



1000 Lb. Engine Support Bar

SKU **079532** **119⁹⁹**
 KT162116

- Designed to Support Front Wheel Drive Engines for Repairs or Servicing of Engine Mounts
- Includes a 1000 Lb. Capacity Transverse Bar that Extends from 34.5" to 61"
- Engine Attachment and Adjustment Hardware Included
- Weight 41.9 Lbs.
- Complies With ASME PALD/2009 Safety Standards

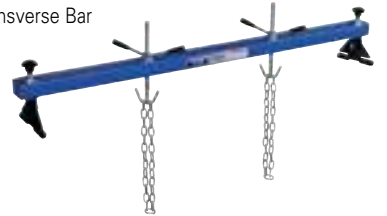

1500 Lb. Engine Sling

SKU **079419** **44⁹⁹**
 KT162115

- For Use with an Engine Crane
- Designed to Level a Load or Adjust at a Specific Angle for Installation and Removal
- Hand Crank and Bearing Mounted Drive Screw for Easy Adjustment
- 4 Mounting Chains and Brackets for Quick Attachment to Engine
- Weighs 14.3 Lbs.
- Complies with ASME PALD/2009 Safety Standards

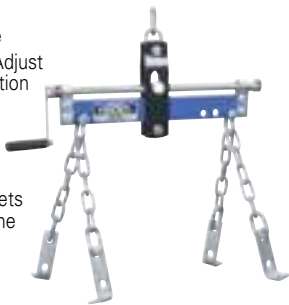

3/4 Ton Utility Underhoist Stand

SKU **079451** **99⁹⁹**
 KT161076

- Support Range from 53" To 79"
- Acme Threaded Screw for Self-Locking Positioning
- Bearing Mounted Spin Handle
- 12" Diameter Base
- Complies with ASME PALD/2009 Safety Standards



3/4 Ton Utility Underhoist Stand with Pedal

SKU **079452** **119⁹⁹**
 KT161077

- Support Range from 53" to 79"
- Acme Threaded Screw for Self-Locking Positioning
- Foot Pedal to Raise Screw Another 1.25" Under 400 Lbs. of Load
- Bearing Mounted Spin Handle
- 12" Diameter Base



2 Ton Tripod Underhoist Stand

SKU **079489** **89⁹⁹**
 KT161002

- Support Range from 68" to 76"
- Acme Threaded Screw for 8" Adjustment
- Bearing Mounted Spin Handle
- Complies With ASME PALD/2009 Safety Standards
- 24" Triangular Base and 3.25" Square Saddle Provides Additional Stability



2 Ton Low Profile Service Jack

SKU **079396** **189⁹⁹**
 KT163101

- Lift Range from 3.5" to 18.1"
- 45.25" Long Pump Handle for Easy Pumping Under Load
- Dual Pump Piston Power Unit Raises Saddle to Maximum Height in 6.5 Full Incremental Strokes
- Load-Limiting and Bypass Valves to Prevent Use Beyond Rated Capacity
- Saddle Diameter 4.3"
- Complies with ASME PALD/2009 Safety Standards



3.33 Ton Capacity Low Profile Service Jack

SKU **079458** **229⁹⁹**
 KT163133

- Lift Range from 3.5" to 21.375"
- 50" Long Pump Handle for Easy Pumping Under Load
- Dual Pump Piston Power Unit Raises Saddle to Maximum Height in 8 Full Incremental Strokes
- Load-Limiting and Bypass Valves to Prevent Use Beyond Rated Capacity
- Complies with ASME PALD/2009 Safety Standards



1000 Lb. Geared Engine Stand

SKU **079534** **349⁹⁹**
 KT162110

- 1000 Lb. Capacity Foldable Engine Stand
- Worm Gear Driven Mounting Plate with Adjustable Fingers Rotates to Desired Position
- 4 Wheel Design with Locking Caster Wheels
- Made of Structural Steel Plate and Tubing for Added Strength
- Weighs 96 Lbs.
- Complies with ASME PALD/2009 Safety Standards



1.5 Ton Foldable Engine Crane

SKU **079417** **429⁹⁹**
 KT163421

- 750 Lbs./ 1,500 Lbs./ 2,250 Lbs./ 3,000 Lbs. Capacity Engine Crane with 4 Different Boom Positions
- Legs and Boom Fold Quickly for Storage
- Fast Rise Pump without a Load
- 48" Long Boom with Chain and Swivel Hook Included
- 4.25" Low Profile Base for Easy Access Under Low Ground Clearance Vehicles
- Complies with ASME PALD/2009 Safety Standards



All K TOOL INTERNATIONAL Items Shown Are Covered By A 2 Year Warranty On Material And Workmanship



OEM TOOLS®

REVOLUTIONARY LUMINATION

USB RECHARGEABLE MULTI-USE WORK LIGHTS

NEW



1000 Lumens
 Rechargeable
 Multi-Use Work Light
 SKU 850288 24604 **199⁹⁹**
 • 9 Hr. Run Time
 on High

600 Lumens
 Rechargeable
 Multi-Use Work Light
 SKU 822266 25997 **69⁹⁹**
 • 6 Hr. Run Time
 on High

330 Lumens
 Rechargeable
 Multi-Use Work Light
 SKU 105560 24605 **49⁹⁹**
 • 3 Hr. Run Time
 on High

200 Lumens
 Rechargeable
 Multi-Use Work Light
 SKU 105545 24603 **39⁹⁹**
 • 3 Hr. Run Time
 on High



ACCESSORIES



Rubber End Casings
 SKU OUTSIDE BUY/EPO
 #24650 **5⁹⁹**



2 Piece Hooks
 SKU OUTSIDE BUY/EPO
 #24606 **9⁹⁹**



Adhesive Sticker
 SKU OUTSIDE BUY/EPO
 #24651 **4⁹⁹**

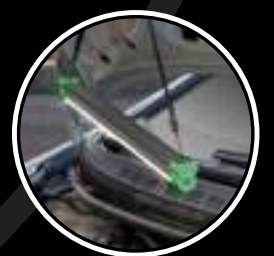

Hanging Strap
 SKU OUTSIDE BUY/EPO
 #24653 **2⁹⁹**



Micro USB Cable
 SKU OUTSIDE BUY/EPO
 #24652 **4⁹⁹**



Dry Bag
 SKU OUTSIDE BUY/EPO
 #24654 **5⁴⁹**
 #24655 **4⁹⁹**
 #24656 **5⁹⁹**

MULTIPLE USES



Underhood

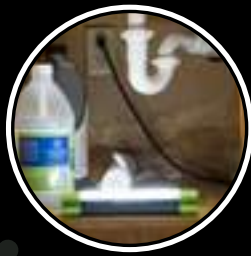

Home Repairs



Garage/Shop



Roadside
Emergency

FEATURES

- Magnetic Back Attaches to Any Ferrous Metal Surface to Hold the Light in Place
- Li-ion Technology Holds Charge for a Longer Runtime
- Comes with Universal Micro USB Cable to Charge Anywhere
- 5 Light Modes to Maximize Runtime: High/Medium/Low/Strobe/S.O.S.
- Bright and Efficient LED Bulbs to Give Higher Runtime with Greater Output
- Light Weight and Compact Size for Easy Transportation
- Charging Indicator Lights: Red (Charging), Green (Fully Charged) and Yellow (20% Battery Remaining)

SAVE \$10

7 LED Rechargeable Work Light

SKU 819644
25982 **39⁹⁹** REG. \$49.99

- 3W COB LED, Super Bright White Lights: 210 Lumens
- 7 LED Torch Light
- 3.7V 2200 mAh Lithium-Ion Battery
- Runtime: 3 Hrs. (Work Light), 20 Hrs. (Torch Light)
- Cordless, Rechargeable
- Powerful Magnets On the Back and Swivel Base
- Over Charge and Discharge Protection
- Recharge Using Included USB Cable



Offer Good Through September 30, 2016 While Supplies Last

Pocket Light

OEM TOOLS

3W CREE Rechargeable Li-Ion Pocket Light

SKU 819643
25980 **29⁹⁹**

- 5 SMD LED Super Bright Work Light – 200 Lumens
- CREE 3W LED Spot Light – 100 Lumens
- 3.7V 1000 mAh 14650 Lithium-Ion Battery
- Powerful Magnetic Pocket Clip



Flashlight

GreatLite



Pro 500 Lumen Rechargeable Flashlight with 450 Lumen Ultra Slim Inspection Light

SKU 798710
32827 **79⁹⁹**

- Professional 500 Lumen Flashlight Head Casts a 170 Meter Beam
- Ultra Slim 450 Lumen Inspection Light Casts a 30 Meter Beam
- Durable Construction and Impact Resistant Up to 1 Meter
- Battery Lasts 3.5 Hours at 100% and Fully Charges in 5 Hrs.
- 5 Light Modes: 100%, 50%, 25%, Strobe and S.O.S.
- Charging Light Indicator Turns On When Less than 10% of Battery Power Remains
- Lightweight, Anodized Aluminum Casing Weighs 4.6-4.7 Oz.
- Includes USB Charging Cord with UL Adapter and (1) 18650 Rechargeable Battery

Work Lights

OEM TOOLS

Handheld Fluorescent Lights

26 Watt
SKU 915801
25984 **49⁹⁹**

13 Watt
SKU 914625
25983 **39⁹⁹**

- Heavy Duty End Caps with Shatterproof Casing
- 360° Rotating Hook
- 15' Cord



Impact Resistant 13 Watt Work Light

SKU 133391
25992 **49⁹⁹**

- Super Bright 13W Fluorescent PCB Electronic Bulb (Provides 95-120 Lux and 300-330 Lumens) with Soft PVC Handle and Top-Cap and Superior Impact Protection
- 18/2 SJTOW 6' Cord that is Oil and Grease Resistant
- 360° Hook Stand Frees Your Hands at Work
- High Impact Resistant Polypropylene



While Supplies Last

Impact Resistant 13 Watt Work Light with Reel

SKU 133474
25993 **149⁹⁹**

- 13 Watt Fluorescent PCB Electronic Bulb (Provides 95-120 Lux and 300-330 Lumens) with Soft PVC Handle and Top-Cap and Superior Impact Protection
- 30' 18/2 SJTOW Oil and Grease Resistant Heavy Duty Cord



While Supplies Last

Heavy Duty Reel with T-Tap

SKU 133483
25994 **199⁹⁹**

- Clear Tri-Tap Illuminates When Receiving Power
- Fully Enclosed Safety Switch, Full Overload Protection
- Hardware Included for Wall or Ceiling Mounting
- Adjustable Ball-Check Stop
- 50' Cord
- 12 Amp Rating



While Supplies Last

36 LED Rechargeable Work Lamp

SKU 210205
33006 **36⁹⁹**

- 4.8 Volt Rechargeable Battery, Recharges in 2 - 3 Hours
- Includes AC / DC Charging Adapters
- Powerful Magnet On Back
- Hanging Hook for Hands Free Operation



GreatLite

24 LED Rechargeable Work Light

SKU 526512
32775 **49⁹⁹** REG. \$59.99

- 24 Super Bright LED Lights
- 700 Lumens
- Runtime: 4 Hour
- Includes: AC/DC 120 Volt Adapter with USB Port and 12V DC Car Charger
- Li-Ion Battery



Offer Good Through September 30, 2016 - While Supplies Last

Bounce Lights

Bounce Lite 13 Watt Work Light with 25' Cord

SKU 186474
CEN12006 **64⁹⁹**

- 25' 18/2 HD Power Cord
- Bounces Instead of Breaking - Features Patented Bounce-Bulb Technology
- Heavier Housing and End Caps for Improved Durability
- Fully Enclosed Safety Switch
- Patented Bounce-Bulb for Superior Impact Protection
- Superior Cord Life



Bounce Lite 13 Watt Work Light with 50' Cord

SKU 186475
CEN12007 **109⁹⁹**

- Bounces Instead of Breaking - Features Patented Bounce-Bulb Technology
- Heavier Housing and End Caps for Improved Durability
- Fully Enclosed Safety Switch
- Patented Bounce-Bulb for Superior Impact Protection
- Superior Cord Life



Bounce Lite Reel and Light

SKU 186477
CEN12010 **189⁹⁹**

- Patented Bounce-Bulb Shock Technology Protects Bulb When Light Is Dropped
- 40' Oil and Water Resistant 18/2 Gauge SJTOW 110 Volt Power Cord
- Heavy Duty Swivel Hook and Fully Enclosed Safety Switch

SKU 186476
CEN12009 **139⁹⁹**

- 25' Oil and Water Resistant 18/2 Gauge SJTOW 110 Volt Power Cord

Bounce Lite Bulbs

SKU 186480
CEN1100617 **22⁹⁹**

- Replacement Bulbs for CEN12009 and CEN12010

Central TOOLS, Inc.
QUALITY AND INNOVATION SINCE 1968



Underhood Lights

Central TOOLS, Inc.
QUALITY AND INNOVATION SINCE 1968

25 Watt Underhood Lite[®] and LitePerch[®]

SKU 186479
CEN13003 **199⁹⁹**

- Hands Free Lighting of Entire Engine Compartment
- Works On All Passenger Cars and Light Trucks
- 25' 18/2 Heavy Duty Power Cord
- LitePerch Opens: 4' to 6.6'



3 Pack Underhood Light Bulbs

SKU 186481
CEN1056026 **79⁹⁹**



DID YOU KNOW?

AutoZone carries bulk packs of mini bulbs and headlight capsules.

Contact Your AutoZone Commercial Sales Manager for Details

LIGHTING

SAVE ON LIGHTING
Offers Good Through September 30, 2016
While Supplies Last

Penlights

E34 Focus Penlights

- SKU **626129**
EXPE34 (Black)
- Comes with (2) AAA Duracell® Batteries
 - Dimensions: 5.83" (L) x 0.57" (D) x 0.63" (Head)
 - Weighs: 1.3 Oz. (Excluding Batteries)
 - Includes Carrying Pouch

- (Silver) SKU **626131** EXPE34SR
(Blue) SKU **626128** EXPE34BE
(Red) SKU **626132** EXPE34RD
(Green) SKU **626130** EXPE34GN

24⁹⁹ REG: \$27.99

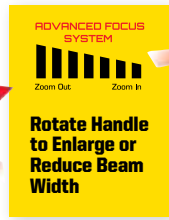

Rotate Handle to Enlarge or Reduce Beam Width



GreatLite

130 LUMENS

Offer Good Through September 30, 2016 - While Supplies Last

Stylus Pro® White LED

SKU **291408**
STL66118 (Black) **27⁹⁹**

- Waterproof Construction with an Unbreakable Polycarbonate Lens As Well As Pocket Clip
- Up to 7.5 Hours Runtime and 48 Lumens

- (Red) SKU **291358** STL66120
(Silver) SKU **291359** STL66121
(Blue) SKU **291362** STL66122



STREAMLIGHT

Rechargeable Lights

Stinger® Rechargeable LED Flashlight with AC/DC PiggyBack Charger

SKU **291368**
STL75732 Black **209⁹⁹**

- Combination of Rechargeability and C4 LED Technology that Produces the Lowest Operating Cost of Any Flashlight Made!
- Ultra-Bright, Far-Reaching Beam Offers Multiple Light Modes, Including Strobe
- 3 Watt Super High Flux LED, Impervious to Shock with a 20,000 Hour Lifetime
- Runtime: High Beam: Up to 1.75 Continuous Hours; Medium Beam: Up to 3.5 Continuous Hours; Low Beam or Strobe: Up to 6.75 Continuous Hours
- Light Output: High: 350 Lumens; Medium: 175 Lumens; Low: 85 Lumens

Strion® Rechargeable LED Flashlight with AC/DC Charger

SKU **295851**
STL74301 Black **179⁹⁹**

- Rechargeable, Ultra-Compact and Powerful, the Strion LED Offers Three Variable Intensity Modes, Strobe Mode and the Latest in Power LED Technology
- C4 LED Technology for Extreme Brightness
- Impervious to Shock, 50,000 Hour Lifetime
- Light Output: High: 260 Lumens; Medium: 130 Lumens; Low: 65 Lumens



Bat Lights

16.25" Long High Performance Bat Light

SKU **432100**
32818 (Black) **29⁹⁹**

- CREE XP-G Bulb
- 200 Lumens
- 72 Hour Runtime
- Comes with (4) AA Batteries
- Water Resistant IPX-4
- 150 Meter Beam Distance

SKU **467250**
32819 (Red)

SKU **467251**
32820 (Grey)



16.25" Long

200 LUMENS

GreatLite

Looks and Feels Like a Baseball Bat!

3 Beam Settings



High Low Flashing

Flashlights

Periscope LED Flashlight

SKU **526504**
25458 **14⁹⁹**

- COB "Chip On Board" LEDs Are the Newest Technology in Lighting
- 2 Meter Beam Distance
- Water Resistant: IPX-3 Rating
- 6 Hours of Continuous Runtime
- Comes with (2) AA Batteries
- Magnetic Bottom to Stand Light Up



60 LUMENS

220 Lumen Light (2 AA)

SKU **544813**
24461 **19⁹⁹**

- CREE-R5 (XPG) Bulb Casts Bright Light
- 220 Lumens
- (3) Light Modes: 100% for 220 Lumens, 50% for 110 Lumens, Flash Mode
- 100 Meter Beam Distance
- Comes with (2) AA Batteries
- 1.5 Hour Runtime
- Water Resistant IP44



220 LUMENS

100 Lumen Light (1 AA)

SKU **544811**
24460 **17⁹⁹**

- CREE-R5 (XPG) Bulb
- (3) Light Modes: 100% for 100 Lumens, 50% for 50 Lumens, Flash Mode
- Comes with (1) AA Battery
- 100 Lumens
- 80 Meter Beam Distance
- 1 Hour Runtime
- Water Resistant IP44



100 LUMENS

E61 EDC Series Flashlight

SKU **347202**
EXPE61 **22⁹⁹**

- Compact and Lightweight
- Aircraft-Grade Aluminum
- Water Resistant Grade IPX-4
- Comes with (1) AAA Battery

Your "EVERY DAY CARRY" Light



80 LUMENS

GreatLite

Accessories

3.7 Volt 18650 Rechargeable Battery
SKU 347210 EXPE03 **19⁹⁹**

Charging Unit for (1) 18650 Battery

SKU 347209 EXPE02 **29⁹⁹**
• Comes with (1) 18650 Battery

Charging Unit for (2) 18650 Batteries

SKU 347208 EXPE01 **59⁹⁹**
• Comes with (2) 18650 Batteries

Search and Rescue Series

Offers Good Through September 30, 2016 - While Supplies Last

- Bright CREE LED Bulbs
- Multiple Light Modes: 100%, 50%, 25%, Flashing and S.O.S.
- Made with Lightweight Aircraft Grade Aluminum for Toughness

E82 LED Pocket Light
SKU 568462 EXPE82 **34⁹⁹** REG: \$44.99
• Comes with (1) AA Duracell® Battery
• Dimensions: 4.2" (L) x 0.9" (D) x 0.9" (Head)
• Weighs: 2.3 Oz. Excluding Battery



100 LUMENS

- Premium Hard-Anodized, Anti-Abrasive Finish that Won't Scratch and Is Impact Resistant
- Sealed Tight with Stainless Steel Rings On Both Ends

E83 LED Pocket Light
SKU 568463 EXPE83 **39⁹⁹** REG: \$47.99
• Comes with (2) AA Duracell® Batteries
• Dimensions: 6.0" (L) x 0.9" (D) x 0.9" (Head)
• Weighs: 2.8 Oz. Excluding Batteries



200 LUMENS

- Anti-Slip Design and Anti-Roll Design
- Toughened Ultra-Clear Glass Lens with Anti-Reflective Coating
- Includes Batteries

E84 LED Stubby Pocket Light
SKU 568464 EXPE84 **39⁹⁹** REG: \$49.99
• Comes with (1) CR123A Battery
• Dimensions: 3.5" (L) x 0.9" (D) x 0.9" (Head)
• Weighs: 2.0 Oz. Excluding Battery



200 LUMENS

Tactical Series

Tactical Body Design for Added Protection and Safety with All of the Features of the Search and Rescue Series

E65 Tactical Flashlight
SKU 347203 EXPE65 **49⁹⁹** REG: \$59.99

- Comes with (2) C Duracell® Batteries
- Dimensions: 6.85" (L) x 1.36" (D) x 1.71" (Head)
- Weighs: 7.8 Oz. Excluding Batteries



SAVE \$10

400 LUMENS

E67 Rechargeable Tactical Flashlight

SKU 462478 EXPE67-E02 **59⁹⁹** REG: \$79.99
• Comes with (1) 18650 Battery and Charger
• Dimensions: 5.51" (L) x 1.04" (D) x 1.37" (Head)
• Weighs: 4.1 Oz. Excluding Battery



SAVE \$20

400 LUMENS

E66 Flashlight

SKU 347204 EXPE66 **64⁹⁹** REG: \$79.99
• Comes with (2) D Duracell® Batteries
• Dimensions: 10.2" (L) x 1.7" (D) x 2.2" (Head)
• Weighs: 13.7 Oz. Excluding Batteries



SAVE \$15

500 LUMENS

E54 Rechargeable Tactical Flashlight

SKU 462477 EXPE54-E01 **99⁹⁹** REG: \$149.99
• Comes with (2) 18650 Batteries and Charger
• Dimensions: 19.9" (L) x 1.04" (D) x 1.37" (Head)
• Weighs: 10.1 Oz. Excluding Batteries



SAVE \$50

700 LUMENS

Offers Good Through September 30, 2016 - While Supplies Last

E81 Rechargeable Flashlight

SKU 462479 EXPE81-E02 **99⁹⁹**
• Comes with (1) 18650 Battery and Charger
• Dimensions: 6.30" (L) x 1.06" (D) x 1.96" (Head)
• Weight: 7.9 Oz. Excluding Battery
• Includes Carrying Pouch and Lanyard



500 LUMENS

Flashlight Only
SKU 347205 EXPE67 **47⁹⁹** REG: \$59.99
(Comes with (2) CR123A Batteries)

SAVE \$12

Flashlight Only
SKU 347207 EXPE81 **59⁹⁹** REG: \$74.99

(Battery and Battery Charger Not Included. Purchase Separately.)

Professional Series

Advanced Focus System Offers Good Through September 30, 2016 - While Supplies Last

E33 LED Focus Flashlight
SKU 568458 EXPE33 **29⁹⁹** REG: \$35.99

- Comes with (1) AA Duracell® Battery
- Dimensions: 4.4" (L) x 0.7" (D) x 1.0" (Head)
- Weighs: 2.0 Oz. Excluding Battery



SAVE \$6

80 LUMENS

E32 LED Focus Flashlight
SKU 568457 EXPE32 **34⁹⁹** REG: \$39.99

- Comes with (2) AA Duracell® Batteries
- Dimensions: 6.36" (L) x 0.73" (D) x 1.04" (Head)
- Weighs: 2.6 Oz. Excluding Batteries



SAVE \$5

120 LUMENS

E31 Focus Flashlight

SKU 568456 EXPE31 **34⁹⁹** REG: \$44.99
• Comes with (3) AAA Duracell® Batteries
• Dimensions: 5.28" (L) x 1.1" (D) x 1.5" (Head)
• Weighs: 4.9 Oz. Excluding Batteries



SAVE \$10

230 LUMENS

E30 LED Focus Flashlight

SKU 568454 EXPE30 **49⁹⁹** REG: \$59.99
• Comes with (3) C Duracell® Batteries
• Dimensions: 8.88" (L) x 1.22" (D) x 1.72" (Head)
• Weighs: 9.3 Oz. Excluding Batteries



SAVE \$10

580 LUMENS

E36 Rechargeable Flashlight

SKU 568461 EXPE36-E02 **69⁹⁹**

OUR BRIGHTEST LIGHT!

- Comes with (1) 18650 Battery and Charger
- Dimensions: 5.4" (L) x 0.9" (D) x 1.1" (Head)
- Weighs: 2.7 Oz. Excluding Battery



800 LUMENS

E36 Flashlight Only
SKU 568460 EXPE36 **54⁹⁹**

- Comes with (2) CR123A Batteries

E87 Rechargeable Flashlight

SKU 568466 EXPE87-E02 **59⁹⁹** REG: \$74.99

- Comes with (1) 18650 Battery and Charger
- Dimensions: 5.4" (L) x 1.0" (D) x 1.4" (Head)
- Weighs: 4.4 Oz. Excluding Battery



SAVE \$15

500 LUMENS

BATTERY SERVICE

JUMP STARTERS

& PERSONAL POWER SOURCES

PPS-X Jump Starter and Personal Power Source with "Smart Jump Cables"

SKU 568481 | 24455

\$199⁹⁹

Li/18000 mAh

Starts a V8 Truck 20 Times and Charges a Laptop



Offer Good Through September 30, 2016 - While Supplies Last



When You Need Extra Power!

ALL OEMTOOLS JUMP STARTERS FEATURE **OEMTOOLS**

- **2A USB Port**
Charges 2X Faster - Charge USB Devices Including Smartphones, MP3 Players and Tablets
- **TSA Checkpoint Friendly**
Bring Your Personal Power Source On the Plane While Traveling for Extra Power
- **Holds Charge 6 to 12 Months**
Always Be Ready - High-Capacity Battery Has a Low Self-Discharge
- **Lithium-Ion Technology**
Uses a High-Capacity Lithium-Ion Battery



PPS-1 Jump Starter and Personal Power Source with "Smart Jump Cables"

SKU 568483 | 24379

\$99⁹⁹

Li/8000 mAh

Travel Safely and Be Ready for Any Emergency
Jump Starts a Car Up to 20 Times and Charges Smartphones and Tablets



Offer Good Through September 30, 2016 - While Supplies Last



PPS Jump Starter and Personal Power Source

SKU 533208 | 24370

\$139⁹⁹

Li/12000 mAh

Jump Starts a V6 Up to 20 Times
95% Lighter Than Lead Acid
Jump Starters



Perfect for the Mechanic!

Offer Good Through September 30, 2016 - While Supplies Last



OBDII Memory Saver

SKU 555447 | 24453

\$39⁹⁹

Save Time and Improve Customer Satisfaction by Saving the Customer's Personalized Settings

- Plugs Directly Into the Vehicle's OBDII to Save Memory While Changing Battery
- Replaceable Fuse to Protect OBD and Sensitive Vehicle Components from Damage
- Preserves Stored Fault Codes and Programmed Electronic Settings Such as Clocks, Radios, Seat Positions, Keyless Entry Systems and More
- For Use with OEMTOOLS Jump Starters Part Numbers 24370, 24454 and Most Lithium-Ion Jump Starters



"Smart Jump Cables" for Jump Starters

SKU 568482 | 24456

\$22⁹⁹

Intelligent Cables That Verify Proper Connection, Making Jump Starting Easy and Safe

- Use with OEMTOOLS Jump Starters Part Numbers 24370, 24379, 24454 and Most Lithium-Ion Jump Starters



PPS-Marine Jump Starter and Personal Power Source

SKU 568480 | 24454

\$149⁹⁹

Li/12000 mAh

Sturdy, Water-Tight Case Perfect for Marine and Outdoor Use

- Same as OEMTOOLS 24370 with a Waterproof Case



Offer Good Through September 30, 2016 - While Supplies Last

Replacement "Smart Jump Cables" for PPS-X Jump Starter

SKU 568470 | 24457

\$24⁹⁹

Intelligent Cables That Verify Proper Connection, Making Jump Starting Easy and Safe

- Use with OEMTOOLS Jump Starter Part Number 24455



DID YOU KNOW?

AutoZone has a Battery Tester Earn Back Program.

Contact Your AutoZone Commercial Sales Manager for Details

Battery Testers

110 Amp Battery Tester

SKU 738495
FJC45110 **39⁹⁹**

- Test 6 and 12 Volt Batteries
- Test Car/Truck Batteries of Current Draw, Voltage and Alternator Performance
- Quick 10 Second Load Test



12V Battery and Electrical System Tester with Built-In Printer

SKU 291331
MIDMDXP300 **699⁹⁹**

- Tests 12V Batteries from 100 to 1400 CCA, Including AGM and Gel
- Integrated Printer Allows Immediate Printing of Test Results



125 Amp Battery Tester

SKU 738491
FJC45107 **39⁹⁹**

- Test 6 and 12 Volt Batteries
- Test Car/Truck Batteries of Current Draw, Voltage and Alternator Performance
- Quick 10 Second Load Test



Battery Conductance Tester

SKU 291330
MIDPBT100 **199⁹⁹**

- Tests Both the Starter and the Charging System
- Tests 12V Automotive Batteries from 200 - 850 CCAs
- Durable Design for the Workshop or in the Field



500 Amp Carbon Pile Battery Tester

SKU 738501
FJC45115 **99⁹⁹**

- Load Capacity: 500 Amps
- Load Test 12 Volt Batteries, Alternators, Regulators and Starters
- Test Batteries Up to 160Ah/1,000 Cold Cranking Amps



Advanced Diagnostic Battery Conductance/Electrical System Tester

SKU 291329
MIDPBT300 **339⁹⁹**

- Tests 12V Automotive Batteries from 100 - 1,400 CCAs
- Voltmeter Mode for Testing Both Starter and Charging Systems
- Accurate Battery Test Decisions in Seconds



1,000 Amp Carbon Pile Battery Tester

SKU 738502
FJC45118 **399⁹⁹**

- Load Capacity: 1,000 Amps
- Load Test 6, 12 and 24 Volt Batteries
- Test Batteries Up to 2,000 Cold Cranking Amps
- 56" Solid Copper Cables with Heavy Duty Clamps



6 and 12V Battery and Electrical System Tester for HD/ Fleet with Integrated Printer

SKU 291334
MIDMDX700PHD **1,399⁹⁹**

- Applications: 6V and 12V Batteries and 12V and 24V Charging Systems
- Battery Types: Flooded, AGM, AGM Spiral and Gel
- Vehicle Applications: Group 31, Automotive, Motorcycle, Marine Cranking, Lawn and Garden, and Commercial 4D/8D Batteries



SAVE \$40

Professional Battery Tester

SKU 544740
24369 **59⁹⁹** REG. \$99.99

- Easy to Understand Menu-Driven Testing for Battery, Starting and Charging Systems
- Battery CCAs: 240 - 2,000
- Includes Fast Test Mode



Offer Good Through September 30, 2016 - While Supplies Last

SAVE \$15

Digital Battery Analyzer

SKU 819073
24359 **49⁹⁹** REG. \$64.99

- Tests Battery, Starting and Charging Systems
- Clear and Easy to Understand Results to Indicate Systems Condition
- Battery CCAs: 200-1200
- Voltage: 7-15VDC
- Testing Standards: SAE, DIN, EN, IEC,



Offer Good Through September 30, 2016 - While Supplies Last

Battery Chargers

Fast Charger Cranking Assist

SKU 344795
ASCUS20 **419⁹⁹**



Professional Fast Charger Cranking Assist

SKU 496661
ASC6012 **614⁹⁹**



BONUS
Battery Tester
SKU 221252 | Part# ASC6029
VALUE: \$149.99



with Purchase of:
Professional Fast Charger
SKU 496661 | Part# ASC6012*

*Qualified Purchases Come with Coupon for Bonus Goods.

Offer Good Through September 30 - While Supplies Last

Jump Starters

Kwikstart® 12 Volt Portable Power and Jump Start

SKU 850637
ASC6256 **209⁹⁹**

- Peak Amp Output: 1700 Amps
- Built-In Charger
- 12 Volt DC Accessory Outlet to Power and/or Recharge DC Electronics
- 32" Heavy Duty Cables



CCA: 350

KS400 KwikStart® Jump Starter

SKU 850635
ASCK5400G **279⁹⁹**

- EXCLUSIVE Heavy Duty 22Ah Sealed AGM Battery provides POWERFUL "Best-In-Class" Performance
- Replaceable Field Serviceable Cables and Battery
- Built-In Digital Voltmeter, 12V Power Port and USB Power Port



CCA: 350

This is Not Your Daddy's KwikStart®.
US-Designed, US-Manufactured, US-Patented.
The LAST Jump Starter You May EVER Need!

Smart Chargers

It is important to use Smart Chargers when charging AGM Batteries. Standard Battery Chargers will not fully charge AGM Batteries and can shorten their life.

6/12V, 12/2/50A Fully Automatic Smart Charger

SKU 850633
ASC3055A **134⁹⁹**

- LED Display Indicates Charge Current, % Charged
- Charges AGM/GEL/SLA and Deep Cycle Battery Types
- 50 Amp Engine Start Feature for 12V Application



6/12V, 12/2/75A Fully Automatic Smart Charger

SKU 850632
ASC3075A **154⁹⁹**

- Charges AGM/GEL/SLA and Deep Cycle Battery Types
- 75 Amp Engine Start Feature for 12V Application
- Automatic Bad Battery Detection



6/12V, 15/2/100A Fully Automatic Smart Charger

SKU 850634
ASC3100A **174⁹⁹**

- Charges AGM/GEL/SLA and Deep Cycle Battery Types
- 100 Amp Engine Start Feature for 12V Application
- Automatic Bad Battery Detection



Avoid the traditional hassles of Power Sports battery handling, preparation, and installation.

EASY
Factory Charged

SAFE
Won't spill,
no adding acid

FUN
Enjoy maximum power

Patented heavy-duty
top and side connection
terminals



POPULAR FITMENT GUIDE:

SKU #	Stock Number	Motorcycle	PWC	ATV	Snowmobile	Utility Vehicle
350076	ETX9	X		X		
350077	ETX12	X		X		X
350083	ETX14	X		X	X	X
350066	ETX14L	X				
350078	ETX15	X		X	X	X
350079	ETX15L	X	X	X	X	
350080	ETX16	X	X	X	X	
350081	ETX16L	X	X	X	X	X
350084	ETX18L	X		X	X	X
178908	ETX20L	X	X	X	X	X
273069	ETX30LA	X	X	X	X	X

A full coverage line,
in stock and ready to go!

Duralast
AGM
Gold

BATTERY SERVICE

Wheel Chargers

FULLY AUTOMATIC OR MANUAL HIGH PERFORMANCE WHEEL CHARGERS WITH VARIOUS CHARGER RATES FOR 6, 12, AND 24 VOLT BATTERIES. Oversized heavy-duty switches, precision timer-controlled operation, large face clear-view amp and volt meters, tubular steel-plated handles with rubber grips, handles are commercial grade, welding grade, high volume cooling fan and heavy-duty steel cabinets with wide-track wheels.

DSR PROSERIES
POWERED BY SCHUMACHER

Engine Start & Charger

SKU 837563
PSW-2035 **199⁹⁹**

- 200A Engine Start
- 35A Rapid
- 2A Trickle Charge

Engine Start & Charger

SKU 837561
PSW-2550 **249⁹⁹**

- 12V 250 Engine Start
- 50/10 Rapid Charge (12V)
- 125A Engine Start
- 50A Rapid Charge (6V)

Engine Start & Charger

SKU 058087
PSW-70030A **299⁹⁹**

- 300A Engine Start
- 70/20/4A Automatic charge
- 40A Manual Charge

Engine Start & Charger

SKU 837566
PSW-61224 **399⁹⁹**

- 250A | 60/35/1.5A (12V)
- 150A | 30/10A (24V)
- 150A | 80/40a (6V)

Engine Start & Charger

SKU 837565
PSW-3060 **449⁹⁹**

- 300A | 60/30/4A (12V)
- 200A | 30A (6V)



Lithium Power

JUMP STARTER + FUEL PACK + BACK-UP POWER

SKU 674858 **149⁹⁹**
SL1

- Scrolling Digital Display
Easy-to-read, animated display gives you step by step instructions to properly jump start your battery
- Ultralight Design
- Jump Starter - Great for power sports, motorcycles and 4-6 cylinder cars.
- 2A USB Port charges all USB devices
- Charge 12V DC devices when traveling. Protect your vehicle settings while switching out your battery. (Memory Saver not included.)
- Lithium Iron Phosphate Battery provides longer life, 5x more cycle life and 4x-5x more cranks than lead-acid battery jumpers.
- Safe Lithium Ion Protection. Spark-free. Built-in safety protection design to prevent overcurrent, short-circuit, overload, overvoltage and overcharge.



JUMP STARTER

SL65 **119⁹⁹**

- LCD Display with On/Off Button
Easy-to-read, display shows battery capacity and input/output
- Compact Design/Travel Bag
This durable case has a soft-touch finish, portable compact design that will conveniently fit in your travel bag, backpack or glove box
- Jump Starter - Quickly starts vehicles in emergencies. Great for power sports, motorcycles and 4-6 cylinder cars.
- 2.1A/1A USB Ports for 2X faster charging.
- Charge all USB devices, including smartphones, mp3 players and tablets.
- Smart Cable provides protection against: reverse polarity, short circuit, low voltage, high temperature and reverse charging.
- Built-In LED Light (3-Modes)



RED FUEL
POWERED BY SCHUMACHER

Jump Starters/Portable Power

ProSeries Jump Start

SKU 747157
PSJ-1812 **189⁹⁹**

- 1800 Peak Amps
- 280 Cranking Amps

ProSeries Jump Start

SKU 069586
PSJ-2212 **249⁹⁹**

- 2200 Peak Amps
- 330 Cranking Amps

ProSeries Jump Start

SKU 362531
PSJ-3612 **379⁹⁹**

- 3600 Peak Amps
- 470 Cranking Amps

ProSeries Jump Start

SKU 069587
PSJ-4424 **679⁹⁹**

- 4400 Peak Amps
- 500 Cranking Amps
- 12 & 24V Applications



Great starting power for cars, sport-utility vehicles, pick-up or light trucks, RVs, and farm and ranch equipment. Units include heavy-duty cases, clamps and cable construction. Built to work with high-output AGM batteries and internal smart chargers. Select models feature an On/Off switch for added safety and an integrated voltmeter for battery/system testing.

Heavy Duty Chargers

4-Battery Charging Station

SKU 069531
INC-4060A **249⁹⁹**

- 6A output per bank
- Separate LED battery status indicator for each bank



8-Battery Charging Station

SKU 069532
INC-812A **679⁹⁹**

- 12/2A output per bank
- 8 completely independent charging banks



Microprocessor Controlled Charger

SKU 747182
INC-3625A **499⁹⁹**

- 36V, 15 to 25A cycling output current
- Charger status LED



Microprocessor Controlled Charger

SKU 747181
INC-4825A **519⁹⁹**

- 48V, 15 to 25A cycling output current
- Charger status LED indicators



DSR products are designed with commercial-grade heavy-duty construction and have patented, state-of-the-art charging, testing and safety technologies, built-in for ease of use and functionality.

Charger/Maintainers

Engine Start & Charger

SKU 837550
PS-2100MA **129⁹⁹**

- 100A Engine Start
- 15/2 Amp Charger

Engine Start & Charger

SKU 837554
PSC-2030T **249⁹⁹**

- 200 Amp Engine Start
- 30A Rapid Charger
- 10A Fast Charge

Engine Start & Charger

SKU 837549
PS-1025 **37⁹⁹**

- 50 Amp Engine Start
- 10A Fast Charge
- 2A Trickle Charge

Charger

SKU 837552
PS-620 **55⁹⁹**

- 6A Medium Charge
- 2A Trickle Charge



DSR Products are designed with commercial grade, heavy-duty construction and have patented state-of-the-art charging technologies built-in for ease of use and functionality. The compact design of our battery chargers allows the user to place anywhere in the shop.

Battery Testers

Digital Tester

SKU 240416
BT175 **87⁹⁹**

- For testing 12 volt batteries, up to 1200 cold cranking amps, battery state of charge, battery cranking ability, charging system output, starter motor draw
- Accurate, easy-to-read LED screen.
- Four LED indicators



Digital Tester

SKU 747180
BTF-250 **159⁹⁹**

- 12 Volt Digital Battery Tester
- Checks both battery and charging system
- Bright digital display - indicates both voltage and test results
- Unique 5-step design - indicates OK, OK & Recharge, Recharge Battery, Recharge & Retest, Bad Cell
- Error LED indicates Reverse hook-up
- Super-Grip battery clamps



ProSeries Tester w/ Printer

SKU 112548
PST-900X **536⁹⁹**

- 3 Tests in 1
- Battery | Starting | Charging





Contact Us:
1-877-AZTool1 Phone
 (1-877-298-6651) *Hablamos Español*

**Booster Cable
 2 Gauge 20' 600P Clamp**

SKU 741369 00186 **149⁹⁹**
 • Made in USA
 • Cables are made of 2 gauge 100% copper conductors
 • Color-coded, tangle-free dual cable construction
 • Specifically designed for maximum flexibility and easy handling



**Commercial Battery Cable Splice -
 2/0 Gauge With Overmold**

SKU 741392 04963 **36⁹⁹**
 • Replaces worn out battery cable terminal end
 • Extends battery cable length
 • Fits up to 3/8" stud
 • Fits positive and negative studs
 • Includes hex wrench
 • Dual set screws for secure connection



**Group 31 Multi-Battery
 Overmolded
 Cable Assembly**

• Made with 2/0 PVC starter cable
 • Attached protective caps to seal connection
 • Fits up to 3/8" stud



2-Battery, Red, 7"
 SKU 741376 04362 **24⁹⁹**

2-Battery, Blk, 7"
 SKU 741382 04363 **24⁹⁹**

3-Battery, Red, 14"
 SKU 741368 04364 **38⁹⁹**

3-Battery, Blk, 14"
 SKU 741387 04365 **38⁹⁹**

4-Battery, Red, 21"
 SKU 741393 04662 **54⁹⁹**

4-Battery, Blk, 21"
 SKU 741388 04663 **54⁹⁹**

**Booster Cable
 4 Gauge 20' 500G Clamp**

SKU 741367 00159 **99⁹⁹**
 • Made in USA
 • Cables are made of 4 gauge 100% copper conductors
 • Color-coded, tangle-free dual cable construction
 • Specifically designed for maximum flexibility and easy handling
 • Patented clamp and jaw designed for 3 jump starting applications: top post, side terminal, and remote battery access terminal



**Commercial Battery Cable Splice -
 2/0 Gauge With Tin Plated Lug**

SKU 741385 04958 **27⁹⁹**
 • Replaces worn out battery cable terminal end
 • Extends battery cable length
 • Fits up to 3/8" stud
 • Fits positive and negative studs
 • Includes hex wrench
 • Dual set screws for secure connection



**Plug In Booster Cable
 2 Gauge 30' 600E Clamp**

SKU 747186 04665 **199⁹⁹**
 • Made in USA
 • Cables are made of 100% copper conductors
 • Color-coded, tangle-free dual cable construction
 • Consists of 5' battery connector cable with plug connector and 25' cable with clamps



**Commercial Battery Cable Splice -
 2/0 Gauge With Brass Top Post Terminal**

SKU 741370 04957 **27⁹⁹**
 • Replaces worn out battery cable terminal end
 • Extends battery cable length
 • Fits positive and negative posts
 • Includes hex wrench
 • Dual set screws for secure connection



**Group 31
 Closed Top Nuts,
 Bag of 25**

SKU 741381 05419 **59⁹⁹**
 • 3/8" - 16 unc thread and 9/16" hex head
 • Stainless steel sintered material
 • Fits Group 31 overmolded cable assemblies



**Protective
 Stud Caps,
 Black, Bag of 10**

SKU 741379 04892 **12⁹⁹**
 • Fits 3/8" Stud
 • Helps protect against corrosion
 • Fits Group 31 overmolded cable assemblies



**Plug In Booster Cable
 4 Gauge 20' 500G Clamp**

SKU 747189 03667 **139⁹⁹**
 • Made in USA
 • Cables are made of 100% copper conductors
 • Color-coded, tangle-free dual cable construction
 • Consists of 5' battery connector cable with plug connector and 15' cable with clamps
 • Patented clamp and jaw designed for 3 jump starting applications: top post, side terminal, and remote battery access terminal



**Power Sports Booster Cable
 10 Gauge 10' 50A Clamp**

SKU 460709 00146 **14⁹⁹**
 • Used For Small Engine/Motorcycle/ATV/ Watercraft Service
 • Tough PVC insulation
 • Tangle-free dual cable construction
 • Storage bag included



**Power Sports
 Charging Post,
 Bag of 25**

SKU 741380 00385 **39⁹⁹**
 • Facilitates charging and testing of power sports batteries
 • Posts have M6 threaded stud to screw into power sports battery terminals
 • Fast finger tight installation



**Protective
 Stud Caps,
 Red, Bag of 10**

SKU 741378 04893 **12⁹⁹**
 • Fits 3/8" Stud
 • Helps protect against corrosion
 • Fits Group 31 Overmolded Cable Assemblies



**OVER 4,000 DIFFERENTIAL PARTS
 AT YOUR FINGERTIPS**



RING & PINIONS



**INSTALLATION &
 BEARING KITS**



AXLES



**LOCKERS &
 POSITRACTION**

**The Widest Selection of Differential
 Parts Available at**

**Find
 DIFF WIZARD
 on Z-Net.**

ENGINE SERVICE TOOLS

STOP the Knock!

Ford Cam Phaser Noise Repair Kit 4.6/5.4 3V

SKU 079897 **699⁹⁹**
24206

- Adding this Kit to a 4.6/5.4L 3V Car, Truck, or SUV Will Help Ensure that Your Cam Phasers Don't Suffer Premature Failure
- Included Timing Chain Wedge Tool Increases Ease of Installation
- Included Simple to Use Vehicle Computer Programmer with OBD-II Cable to Disable Cam Phaser Function
- One Kit Corrects Both Cam Phasers
- Cam Phaser Is NOT INCLUDED

This Kit is a True, Long Term Repair for Ford Cam Phaser Noise



OEM TOOLS

Ford Timing Chain Locking Wedge Tool (4.6/5.4 3V Engines)

SKU 012647 **19⁹⁹**
24207

NEW

- For 2005-14 5.4L and 4.6L 3V
- OE Type Tool
- Allows For Easy Cam Changes Without Removing The Timing Cover



Stop Saying No to Business and Be Confident Your Customers Will Be Satisfied!

SAVE \$10

Timing Gear Holder

SKU 544797 **39⁹⁹**
24387 REG. \$49.99

- Holds the Timing Gear in Place During Removal and Installation and Prevents It from Moving While the Retaining Bolt Is Removed
- Allows the Cam Gear to Rotate to Align Valve Timing Marks
- Single Lever Locking Design Is Easy-to-Use

Offer Good Through September 30, 2016 - While Supplies Last



Valve Tools

Valve Spring Compressor

SKU 231210 **19⁹⁹**
25220

STORE STOCK

- Designed for Use On Most Trucks and Cars with Overhead Valves



Push Rod Remover

SKU 459100 **24⁹⁹**
LIS48300

- Re-Designed for Newer 3.5L and 3.6L GM Engines - Also Works On GM V6 2.8L, 3.1L and 3.4L
- Quickly Removes Push Rods to Replace the Intake Gaskets without Removing Rocker Arms



Valve Keeper Remover and Installer Kit

SKU 011658 **69⁹⁹**
LIS36050

- For Use with Valve Stems from 4.5 to 7.5mm and 5/16" to 3/8"
- Magnet in Tool Body Captures Keepers
- Works on Toyota 4 Cylinder and Chrysler New World Engine Applications

Ford Valve Spring Compressor

SKU 626111 **69⁹⁹**
24434

- Applications: 1991-2004 Ford Vehicles with 4.6L, 2V, V8 Engines; 4.6 4V, 5.4 V8 and 6.8 V10
- Works with Engine Removed or Installed, Cylinder Head On or Off
- Not for Triton 5.4 3V



Parallel Lift Spring Compressor

SKU 516515 **71⁹⁹**
27075

- Strong but Light Frame - Weighs Only 6 Lbs.
- Works with Most Valve-in Head and L-Head Engines As Well As Truck and Tractor Engines
- Capacity 1" - 2" Springs
- Throat Depth 10"
- Includes Straight and Offset Jaws



Piston Tools

Piston Ring Compressor (2-1/8" - 5")

SKU 531921 **13⁹⁹**
25037

STORE STOCK

- Constructed of High Grade Spring Steel with 1/4" Square Drive Adjuster
- Beaded Edge Prevents Tool from Entering Cylinder with Pistons



Piston Ring Compressor (3-1/2" - 7")

SKU 531947 **16⁹⁹**
25039

STORE STOCK

- Constructed of High Grade Spring Steel with 1/4" Square Drive Adjuster
- Beaded Edge Prevents Tool from Entering Cylinder with Pistons



Wrinkle Band Compressor

SKU 246373 **22⁹⁹**
25257

- 1-1/2" Deep Low Friction Wrinkle Band
- Fits 3" to 5" Pistons



Ridge Reamer

SKU 532325 **31⁹⁹**
25051

- Capacity 3" to 5" (76 mm to 127 mm)
- For Use On Conventional and Slant-Block Engines



Piston Ring Compressor Set

SKU 526501 **34⁹⁹**
WLMW89410

- You Get Six Band Sizes for Multiple Applications and the Pliers Can Be Used Parallel or Perpendicular to the Cylinder Block
- Set Comes in a Blow Mold Case
 - 2-7/8" - 3-1/8" (73 - 79 mm)
 - 3-1/8" - 3-3/8" (79 - 86 mm)
 - 3-3/8" - 3-5/8" (86 - 92 mm)
 - 3-5/8" - 3-7/8" (92 - 98 mm)
 - 3-7/8" - 4-1/8" (98 - 105 mm)



While Supplies Last

SAVE \$20

Camshaft and Crankshaft Seal Tool Kit

SKU 544799 **79⁹⁹**
24386 REG. \$99.99

- Easily Remove and Install Camshaft and Crankshaft Seals
- Compact Puller with Unique Extracting Hooks Engage Seal for Quick Removal
- Interchangeable Sleeves and Mandrels Allow Easy Installation of New Seal
- Suits Seals from 21.5 mm - 64 mm
- Sleeves and Mandrels Made from High Strength Fiber Glass Reinforced Polymer



Offer Good Through September 30, 2016 - While Supplies Last

Scan for Instructions on How to Use This Universal Seal Tool Kit

Cam/Crankshaft Tools

Ford 2.0L, 2.3L, 2.5L Cam Tool Kit

SKU 626108 **24⁹⁹**
24448

- Applications: 2.0L DOHC Engines Found in 1994-2003 Ford and Mercury, 2004-2012 Ford and Mercury, 2.3L DOHC 4V and 2.0L DOHC Engines in Ford, Mercury and Mazda, and 2.0L DOHC Engines in 1993-1994 Ford Probe



5 Piece Master Cam Clamp Kit

SKU 383452 **79⁹⁹**
27210

- Covers Most Single, Twin Cam and Quad Cam Engines
- Locks Camshaft to Hold Valve Timing During Timing Belt Replacement



17 mm Crank Bolt Socket

SKU 818785 **29⁹⁹**
CAL981

19 mm Crank Bolt Socket

SKU 818784 **29⁹⁹**
CAL982

21 mm Crank Bolt Socket

SKU 818782 **29⁹⁹**
CAL983

- Remove Stubborn Crankshaft Pulley Bolts - No Special Tool Required
- Increase Working Torque Up to 50%
- Works with Any Standard 1/2" Impact

Cal Van Tools



DOHC Cam Lock Holder

SKU 291419 **39⁹⁹**
LIS36880

- This Versatile Tool Easily Locks and Holds Both Camshaft Sprockets Firmly in Place
- Preserves the Engine Timing During Belt or Chain Replacement



Universal Cam Adjuster

SKU 222524 **41⁹⁹**
LIS38220

- Adjusts to Fit Different Size Cam Sprockets
- Holds Cam Sprocket in Place When Removing Cam Bolt
- Works On All Single and Dual Overhead Cam Sprockets with Holes



Universal Camshaft Bearing Tool

SKU 191677 **229⁹⁹**
27143

- Removes or Inserts Camshaft Bearings in Nearly All Engines
- Easy On Bearings
- Range: 1.125" to 2.69"
- Set Includes: Driving Shaft, Driving Shaft Extension, Expander Unit, (5) Split Driving Plugs, (2) Driving Collars and Center in Cone



Honda Crankshaft Pulley Holding Tool

SKU 217379 **39⁹⁹**
27176

- Holds Crankshaft Dampeners When Tightening/Loosening Crankshaft Bolts On Honda and Acura Engines 1990 to Present



DID YOU KNOW?

Autozone has availability to over 14,000 unique part numbers for replacement engines and transmissions.

Contact Your AutoZone Commercial Sales Manager for Details



Contact Us:
1-877-AZTool1 Phone
 (1-877-298-6651) *Hablamos Español*

Throttle Depressors

Brake - Accelerator Pedal Depressor
 SKU 802194
 24232

- Easy to Adjust
- Extends to 24"
- Suitable for Many Diagnostic Applications

OEM TOOLS



Throttle Pedal Depressor
 SKU 222525
 LIS48700

- Holds Throttle at a Constant RPM
- Length: 40"



Belt Tools

Stretch Belt Installation Tool
 SKU 227301
 24363

- Works On Both Large and Small Pulleys
- Clamping Jaw Allows User to Position Serpentine Belt without the Belt Slipping Out of the Tool

OEM TOOLS



Stretch Belt Mate Kit
 SKU 544729
 24388

- Easily Installs All Stretch Fit Belts

OEM TOOLS



Scan for Instructions on How to Use Stretch Belt Mate Kit

Stretch Belt Remover and Installer
 SKU 255866
 LIS59370

- Unique Magnetic Faces Hold the Tool in Place On the Pulley
- Compact, One-Piece Tool Can Be Used On the Front or Back Side of the Pulley

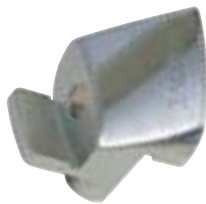

Serpentine Belt Tool
 SKU 695121
 33627115

- Provides Required Leverage and Clearance to Release Spring Pressure and Remove Tensioner Pulley

OEM TOOLS



Block Testers

Block Tester
 SKU 695104
 33627145

- Locate Internal Combustion Leaks Quickly and Easily
- When Fluid Turns from Blue to Yellow a Combustion Leak Is Present

OEM TOOLS



Block Tester Test Fluid (8 Oz.)
 SKU 391381
 25739

- Use with Block Tester #33627145

OEM TOOLS



Engine Cylinder Honers

Adjustable Engine Cylinder Hone Deglazer
 SKU 532002
 25041

- Range: 2" to 7" (51 mm to 128 mm)
- Spring Tension Adjusting Nut for Positive Cutting Action at All Speeds
- Supplied with 4" Medium Grit Stones

FLEX-HONE

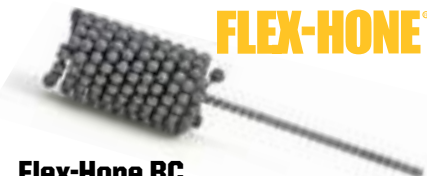

Flex-Hone BC
 10 mm (.394") 6.4 mm (.250")
 SKU 341249 SKU 343384
 BRMBC10M18 BRMBC64M24
24⁹⁹ **24⁹⁹**

FLEX-HONE



Flex-Hone GB
 3-1/2" (89 mm) 3-1/4" (83 mm)
 SKU 341239 SKU 341232
 BRMGB31212 BRMGB31412
47⁹⁹ **47⁹⁹**

Replacement Stone Sets

SKU 141540 2541C **11⁹⁹** STORE STOCK • 3 Coarse Grit (#100)
 SKU 532036 2541M **11⁹⁹** STORE STOCK • 3 Medium Grit (#220)
 SKU 532044 2541F **9⁹⁹** STORE STOCK • 3 Fine Grit (#400)



3-3/4" (95 mm) 4-1/8" (105 mm) 4-5/8" (118 mm)
 SKU 341317 SKU 341325 SKU 341332
 BRMGB33412 BRMGB41812 BRMGB45812
53⁹⁹ **57⁹⁹** **63⁹⁹**

CALL FOR ADDITIONAL SIZES

SAVE \$70

Crankshaft and Camshaft Seal Kit

SKU 512952 27222 **79⁹⁹** REG. \$149.99

- Install and Remove Oil Seals Between 27mm and 58mm in Diameter

NEW



Offer Good Through September 30, 2016 While Supplies Last

DID YOU KNOW?

We carry pump and timing component kits.

Contact Your AutoZone Commercial Sales Manager for Details

Fan Clutch Tools

Universal Pulley and Fan Clutch Holder

SKU 547013 27281 **69⁹⁹**

- Fits Many Different Fan Clutches, Cam and Crank Pulleys with Slots or Holes
- Pin Sizes: 6 - 10 mm, 8 - 11 mm, 10 - 12 mm, 11 - 16 mm
- Adjustable Diameter: 1-1/2" - 8-5/8"



Fan Clutch Service Set for Mercedes-Benz and BMW

SKU 512958 27224 **199⁹⁹**

- Removes Lock Nuts On Thermo Viscous Fans Found On Mercedes-Benz, BMW and Many Ford Models
- Includes: (1) Mercedes-Benz Fan Clutch Wrenches - 36mm, 40mm and 65 mm Opening (1) BMW Fan Clutch Wrench - 32 mm Opening (1) BMW Fan Clutch Holding Wrench - 38 mm and 44.5 mm and 1 Mercedes-Benz Fan Clutch Holding Tool



Universal Fan Wrench Set

SKU 080554 LIS43600 **73⁹⁹**

- Use On the Most Popular Applications
- Unique Hooked Wrench Design Will Hold Bolted On Water Pump Pulleys By Applying Pressure Against Another Bolt
- Double-Sided Spanner Style Holding Wrench Will Hold Pressed On Pulleys On Many GM, Jeep and Dodge Vehicles



Fan Clutch Wrench Set

SKU 110280 27186 **79⁹⁹**

- OEM Master Fan Clutch Wrench Set Combines OEM #27108 and OEM #27141 into a Master Set
- Ideal for Removing Fan Clutches from Water Pumps
- Set Includes: 36, 40, 48, 54, 57, 68, 72, 76 and 83 mm Wrench Sizes



Pneumatic Fan Clutch Wrench Set

SKU 291409 LIS43300 **182⁹⁹**

- Quickly Removes and Installs Fan Clutch When Repairing the Water Pump or Fan Clutch
- Set Includes: 36, 41 and 42 mm; 1.5", 1-9/16", 1-7/8" and 2" Wrench Sizes

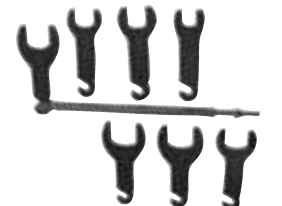

Clutch Tools

Duramax Flywheel Lock

SKU 301613 LIS22100 **49⁹⁹**

- Locks Flywheel in Place When Removing Harmonic Balancer On 6.6L Duramax with Allison Transmissions
- Saves Time By Locking the Flywheel at the Transmission Instead of Having to Remove the Starter for Water Pump Replacement



Flywheel Turner

SKU 505066 LIS23800 **34⁹⁹**

- For Turning and Holding Flexplates and Flywheels
- Easily Turn Engine from Underneath the Vehicle



Freeze Plug Tool

Master Freeze Plug Installation Tool Kit

SKU 965837 27208 **99⁹⁹**

- Designed to Remove and Install Freeze Plugs Used in Liquid-Cooled Gas and Diesel Engines



CHASSIS/SUSPENSION

SAVE \$50

23 Piece Hub Bearing Remover and Installer Kit

SKU 094804 27205 **149⁹⁹** REG. \$199.99

- Removes and Installs Wheel Bearings with Steering Knuckle and Strut Assembly Still On the Vehicle, Eliminates Need for Alignment



Offer Good Through September 30, 2016 While Supplies Last

SAVE \$21

Rear Axle Bearing Remover Set

SKU 821450 33627305 **49⁹⁹** REG. \$70.99

- Strike the Axle Popper Wedge or Use It As a Pry Bar to Remove the Half Shaft
- Shim Included to Fill the Gap On Some Vehicles

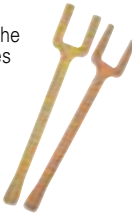

Offer Good Through September 30, 2016 While Supplies Last

SAVE \$30

Axle Spindle Threading Set

SKU 514007 27233 **49⁹⁹** REG. \$79.99

- Set Includes: M20 x 1.25, M20 x 1.50, M22 x 1.00, M22 x 1.50, M24 x 1.50, M24 x 2.00, 13/16" x 20 UNEF, 3/4" x 20 UNEF and 27 mm Extension Bar



Offer Good Through September 30, 2016 While Supplies Last

Axle Tools

FWD Axle Puller Adapter

SKU 695592 33627058 **20⁹⁹**

- Used to Pull CV Drive Axles from the Transmission of Front Wheel Drive Cars
- Note: Use with OEM Slide Hammer #27033 and #33627033



Axle Puller

SKU 695612 33627032 **25⁹⁹**

- Used with OEM Slide Hammer (#27033 and #33627033) to Pull Flange Type Axle On Most Domestic Cars and Trucks with 4.5 or 5.5 Bolt Circles



5 Lbs. Slide Puller

SKU 695611 33627033 **45⁹⁹**

- Threaded 5/8" x 18
- Works with OEM Attachments As Well As Other Manufacturer's Attachments with the Same Thread



Axle Popper II

SKU 010119 39⁹⁹ SKT71415

- Antenna Wrench II Works in Conjunction with Antenna Wrench (21600)
- Tapered on Both Ends
- Fits in Air Hammer
- Increased Base Size for Additional Strength
- Safer Than a Pry Bar



Front Wheel Drive Hub Puller

SKU 695606 33627037 **25⁹⁹**

- Fits Most Domestic and Import Vehicles with Independent Front Wheel Suspension
- Yoke and Bolt Are Threaded 5/8" x 18



4WD Spindle Puller Attachment

SKU 695583 33627104 **35⁹⁹**

- Use with OEM Slide Hammer #27033 and #33627033
- Fits Most Spindles 1-1/2", 1-5/8" and 2" On 4WD Vehicles



Rear Axle Bearing Remover Set

SKU 695117 33627129 **55⁹⁹**

- Used to Pull Semi-Floating Rear Axle Bearings
- Use with OEM #27033 and #33627033 Slide Hammer



Rear Axle Puller Set

SKU 094801 27202 **99⁹⁹**

- Use for Flange-Type Rear Axle and Bearing Removal On Most Late Model Passenger Cars and Light-Trucks



Suspension

GM Upper Control Arm Knock Out Tool

SKU 420336 24210 **19⁹⁹**

- Serves 1989-2001 Chevrolet and GMC 1/2 - 3/4 and 1 Ton, 2 and 4 Wheel Drive Trucks and 1990-2002 All Wheel Drive Chevrolet Astro and GMC Safari Vans



Universal Steering Knuckle Spreader Tool

SKU 512957 27234 **89⁹⁹**

- Used to Spread Lower Ball Joint, Preventing Costly Damage to Knuckle



Camber Adjustment Tool

SKU 360484 DOWTC614 **254⁹⁹**

- Makes Camber Adjustment a "One-Man Job"
- Inflatable Air Bladder Fits Between Tire and Strut for Easy and Controlled Adjustment of Camber Settings
- Camber Can Be Set with Wheels On Ground
- Eliminates the Need for Special Camber Bolts



CV Boot Tools

CV Boot Driver

SKU 695597 33627052 **49⁹⁹**

- Removes and Installs Many Boots On GM Constant Velocity Joints Having Stamped Retaining Rings



Ball Joint

Ball/U-Joint Press Set

SKU 695617 33627023 **115⁹⁹**

- Removes and Replaces Ball Joints On Many Vehicles
- C-Clamp Frame Press May Also Be Used to Remove and Replace U-Joints



Ball/U-Joint Press with 4WD Adapter Set

SKU 695584 33627089 **139⁹⁹**

- 1967 to Current 1/2 to 3/4 Ton 4WD
- Dana 44 Series Front Axle Adapter Sets Available: 27163, 27164, 27165, 27166, 33627163, 33627164, 33627165 and 33627166



Master Ball Joint Installer/Remover Adapter Set

SKU 793562 33627310 **135⁹⁹**

- Expands the Capabilities of OEM #27023 Ball Joint Press
- For Working On Many GM, Ford and Chrysler 2 and 4 WD Pick-Ups, Vans and SUVs
- Includes: 8 Receiving Tubes, 2 Installing Tubes, 2 Receiving Cups, 1 Plug and 1 Remover/Installer
- Comes in a Sturdy Blow Mold Case



Ford Ball Joint Adapter Set

SKU 695095 33627163 **85⁹⁹**

- 1996-2004 Ford Taurus and Mercury Sable
- Ball Joint Adapter Set for #27023, #33627023, #33627089 or #27089
- Rust Resistant Finish On All Parts



4 Wheel Drive Ball Joint Adapter Set

SKU 695093 33627165 **85⁹⁹**

- Designed for Use On 1967 - Current 4WD Vehicles with Dana 44 Axles
- Upper and Lower Ball Joint Adapter Set for 27023, 33627023, 27089 and 33627089



3/4" Drive Ball Joint Impact Socket 2-9/64"

SKU 462494 24215 **24⁹⁹**

- Used On Chrysler/Dodge Mid Size Cars, Light-Trucks and Vans
- Fits 2-9/64" Ball Joints
- 3/4" Drive



2 Wheel Drive Ball Joint Adapter Set

SKU 695092 33627166 **85⁹⁹**

- Ford Van 2WD, Upper and Lower
- Ball Joint Adapter Set for #27023 and #33627023
- Rust Resistant Finish On All Parts



Honda Ball Joint Adapter Set

SKU 695094 33627164 **110⁹⁹**

- 1980-2000 Honda Accord, Civic, CRX and Prelude



Ball Joint Separator

SKU 793569 33627308 **30⁹⁹**

- Used for Separating the Ball Joint from the Spindle Support Arm On Domestic and Import FWD Vehicles
- Adjustable for Different Size Ball Joints
- Max. Opening Range: 1-1/8" and 2-1/8"
- Steel Construction with Black Oxide Pins
- Comes in a Sturdy Blow Mold Case



Spindle Nut

1/2" Drive Socket Bearing Locknut

SKU 231203 25243 **14⁹⁹**

- Fits Adjusting Nuts Found On 1995-96 Ford F150 Trucks and Full-Sized Broncos with Automatic Locking Hubs



4WD 4 Lug Spindle Socket

SKU 552265 25072 **19⁹⁹**

STORE STOCK



4WD 6 Lug Spindle Socket

SKU 695598 33627046 **20⁹⁹**



1/2" Drive Wheel Bearing Locknut Socket Kit

SKU 295858 WLMW89314 **49⁹⁹**

- 6 Point Wheel Bearing Locknuts Are Easy to Remove or Install with These Specially Designed Sockets
- Contains 2-3/8", 2-1/2" and 55 mm Locknut Sockets and 2-1/2", 2-3/4", 2-9/16" and 2-3/8" Rounded Locknut Sockets



While Supplies Last

Axle Bridget Socket for GM

SKU 849599 LIS31550 **57⁹⁹**

- Socket Has 9 Drive Pins
- Made from Alloy Steel
- Use with 1/2" Drive
- For GM Vehicles



Spindle Locknut Wrench Kit

Spindle Locknut Wrench Kit

SKU 695087 33627174 **110⁹⁹**

- Ideal for 4 Wheel Drive Axle Retainers
- Use with Many 1/2 Ton Vehicles with Dana 44 Series Axles GM, Ford and Dodge and with Many 3/4 Ton Vehicles with Dana 70 Series Axles GM, Ford and Dodge



Pickle Fork

Tie Rod End Puller

SKU 004463 25201 **11⁹⁹**

- Tapered Fork Wedged Ends with 21/32" Opening
- Overall Length: 11-7/8"



Ball Joint Separator

SKU 004464 25202 **11⁹⁹**

- Tapered Fork Wedged Ends with 5/16" Opening



3 Piece Pickle Fork Set

SKU 802196 27080 **34⁹⁹**

- Can Be Used for Tie Rod End, Pitman Arm and Ball Joint Removal

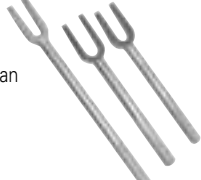

5 Piece Pickle Fork Set

SKU 466511 25261 **35⁹⁹**

- Set Includes: Tie Rod Spreader with 11/16" Wedge Opening, Ball Joint Separator with 15/16" Jaw Opening, Pitman Arm Wedge with 1-1/8" Opening, 8" Handle



Stepped Pickle Fork Set

SKU 291410 LIS41400 **59⁹⁹**

- 6 Tools in One Includes: 1-1/8", 15/16", 11/16" Forks and 2 Handles



5 Piece Tie Rod and Ball Joint Set

SKU 094799 27201 **69⁹⁹**

- Used to Remove Tie Rods and Ball Joints
- Includes: 11" x 1-1/8", 11-3/4" x 1-5/8", 11-5/8" x 1-7/16", 16" x 11/16" and 16" x 15/16"





Contact Us:
1-877-AZTool1 Phone
 (1-877-298-6651) *Hablamos Español*

CV Axle Nut Sockets

1/2" Drive Axle Nut Sockets **OEM TOOLS**

- 30 mm STORE STOCK**
SKU 079988 25203 **14⁹⁹**
- 32 mm STORE STOCK**
SKU 552315 25204 **14⁹⁹**
- 33 mm STORE STOCK**
SKU 864643 25152 **14⁹⁹**
- 34 mm STORE STOCK**
SKU 010252 25205 **14⁹⁹**
- 35 mm STORE STOCK**
SKU 864642 25153 **18⁹⁹**
- 36 mm STORE STOCK**
SKU 079772 25206 **19⁹⁹**

- Removes and Installs the Front Drive Hub/Axle Nuts On 4 Wheel Drive and Many Front Wheel Drive Automobiles
- For Use with a 1/2" Drive Ratchet
- 1/2" Drive Chamfered Square Drive



6 Point Axle Nut Socket Set

SKU 900822 27188 **84⁹⁹**

- Includes: 27, 29, 30, 32, 33, 34, 35, 36, and 38 mm
- Chrome Moly Sockets Are Impact Rated
- Black Oxide Finish to Resist Rust
- Comes in a Blow Mold Case



39 mm, 12 Point Axle Nut Socket

SKU 452638 LIS39650 **24⁹⁹**

- Fits Toyota/Lexus



12 PT Axle Nut Socket 1/2" Drive **20⁹⁹**

- 29 mm SKU 821446 | 33627322
- 30 mm SKU 191051 | 25157
- 31 mm SKU 821448 | 33627324
- 32 mm SKU 821449 | 33627325
- 33 mm SKU 821451 | 33627326
- 34 mm SKU 821453 | 33627327
- 35 mm SKU 821455 | 33627328
- 36 mm SKU 821456 | 33627329
- 38 mm SKU 821457 | 33627330
- 39 mm SKU 821452 | 33627331

SAVE \$30

12 Point Axle Nut Socket Set **OEM TOOLS**

SKU 751696 24480 **59⁹⁹** REG: \$89.99

- Includes Sizes: 29, 30, 32, 34, 35, 36, 38 and 39 mm
- Chrome Moly Sockets Are Impact Rated
- Black Oxide Finish to Resist Rust
- Comes in a Blow Mold Case



Offer Good Through September 30, 2016 - While Supplies Last

Tie Rod Tools

Inner Tie Rod Tool

SKU 094645 25296 **19⁹⁹**

STORE STOCK

- Used to Easily Turn Tie Rods
- Slide Tool Over the End and Tighten Collar to Allow Access with an Extension
- Tool Can Remove Inner Tie Rod without Removing the Outer Tie Rod



Tie Rod End Remover

SKU 695086 33627175 **40⁹⁹**

- Used On Import and Many Front Wheel Drive Vehicles and Rack and Pinion Steering
- Pressure Screw Tip Swivels for Damage Free Results and Will Not Damage Tie Rod End Dust Boots



Inner Tie Rod Tool

SKU 291414 LIS45750 **89⁹⁹**

- Utilizes Six Sizes: 1-1/4", 1-1/2" 1-3/16" 1-5/16", 1-7/16" and 33.6 mm
- Long Socket Slips Over Tie Rod End and Connects to the Crow Foot
- Includes 1-1/2" Crow Foot for Use On Chevrolet Colorado and GMC Canyon



Master Inner Tie Rod Tool

SKU 080557 LIS46800 **148⁹⁹**

- Works On Inner Tie Rods with Inaccessible Wrench Flats
- Includes All 9 Crows Feet to Work On Many Applications
- Long Socket Slips Over the Tie Rod End and the Crow Foot Engages On the Socket for Easy Removal and Installation



Shock Tools

Volvo Shock Retaining Nut Strut Removal Socket Tool

SKU 300125 24365 **24⁹⁹**

- Includes Holding Socket and "Double D" Axle Center Socket
- Fits Several Models Volvo 1999-2010



Universal Shock Absorber Tool

SKU 036202 25038 **16⁹⁹**

- For Removing and Installing Shock Nuts
- Fits Many Shock Stems



Spring Compressors

Universal Strut Remover

SKU 141509 25423 **29⁹⁹**

- Removes the Top Nut On Many MacPherson Struts
- Deep Socket Is Used to Remove Nut
- Includes: 3/4" Adapter, 6.5 mm Hex As Well As "Double D" and 7.5 mm Hex and "Double D" Sockets
- Comes with T-50 Star and 10 mm Internal Hex and "Double D" Sockets



Coil Spring Compressor

SKU 695608 33627035 **50⁹⁹**

- Used to Compress the Coil Spring in the Installation of Coil Spring Spacers
- Comes in a Sturdy Blow Mold Case



Strut/Coil Spring Compressor Kit

SKU 094802 27203 **79⁹⁹**

- Used to Compress Most Sizes of MacPherson Springs and Coil Springs
- 10 Piece Kit
- Heat-Treated for Toughness
- Comes in a Blow Mold Case



Air Operated Strut Spring Compressor

SKU 544805 24860 **699⁹⁹**

- Foot Controlled Valve
- Maximum Air Pressure: 116 PSI
- Spring Diameters: 4-6.5"
- Upper Yoke Travel: 16.5"
- Maximum Load: 2,200 Lbs.



MacPherson Strut Spring Compressor

SKU 070135 25550 **34⁹⁹**

STORE STOCK

- Used to Compress Strut Spring During Cartridge Replacement
- Forged Hook
- Heat-Treated Forcing Screw
- Safety Latches



Model 7600 Strut Spring Compressor

SKU 547959 BRA7600 **899⁹⁹**

- Handles the Toughest Applications
- Min/Max. Spring Diameters: 3.5/11.5"
- Made in the USA



Cart for BRA7600

SKU 547960 BRA00-0137 **389⁹⁹**

Bench Mount for BRA7600

SKU 547962 BRA00-0125 **54⁹⁹**

GM Torsion Bar Unloading Tool

SKU 099289 27235 **99⁹⁹**

- Built for GM's K-3500 Series Trucks with the Heavy Duty Chassis
- Also Works On 1988 and Newer GMC and Chevrolet 1/2, 3/4 and 1 Ton Pick-Ups; S-10 Blazers, S-15 Jimmys, 4WD Pick-Ups with 4.3L V-6 Engines and 1991 to 2001 Oldsmobile Bravada



Pitman Arm Pullers

Pitman Arm and Ball Joint Front End Service Kit

SKU 900820 27181 **99⁹⁹**

- Services Pitman Arm, Tie Rod and Ball Joints
- Includes: Pitman Arm/Tie Rod End Puller, Ball Joint Separator, Pitman Arm Puller, Ball Joint/Tie Rod End Remover
- Comes in a Sturdy Blow Mold Case



Heavy Duty Pitman Arm Puller

SKU 695090 33627170 **90⁹⁹**

- Services Cars and Light Trucks 3/4 Ton
- Can Be Used for Bearing, Collar or Gear Removal
- Features Forged Adjustable Jaws and Two Clamp Bolts that Lock Jaws Together
- Pressure Screw Has Ball Head Designed for Striking



Pitman Arm Puller

SKU 695620 33627016 **17⁹⁹**

- Heat-Treated Frame for Strength and Durability
- Pressure Screw Has Ball Head Designed for Striking
- Frame Has Opening for 1-3/16" Shafts



Pitman/Tie Rod Arm Puller

SKU 695618 33627022 **17⁹⁹**

- For Use On Compact Cars and Smaller Pitman Arms
- 2-1/16" Opening



Seal Tools

Seal Puller

SKU 048199 25014 **12⁹⁹**

STORE STOCK

- Two Tips Fit All Seal Sizes

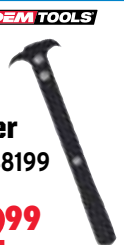

Bearing Race and Seal Driver Set

SKU 695119 33627119 **60⁹⁹**

- Used to Install Most Standard Wheel Bearing Races and Seals

Universal Seal Installer Kit

SKU 818737 25082 **39⁹⁹**

- Knurled Handles
- Includes: 3" Driver, 2.5" Driver, Short Handle, Long Handle, Spider Insert, 5/16" x 1" Cap Screw, Large Spider, Small Spider and Washer
- Long Handle Provides Good Flexibility When Installing Pinion Seals
- Comes in a Sturdy Blow Mold Case



Pinion Shaft Seal Driver

SKU 080559 LIS56950 **89⁹⁹**

- Used for Driving Pinion and Other Seals into Place
- Hollow Adapter Allows Driver to Slide Over Shaft to Drive Seal
- Neodymium Magnets On Both Driver Faces Hold Seal in Place Until Ready to Drive into Place
- Works On Many Applications (Ford SUV Pinion Seals)



Drive Line Impact Socket

1/2" (12 mm) Ford Drive Line Impact Socket

SKU 420319 24212 **19⁹⁹**

- Applications Include Many Ford Drive Line Bolts
- 12 mm, 12 Point



SERVICE TOOLS

SAVE \$20

Professional Micrometer Adjustable Torque Wrenches 1/2" Drive

SKU 133659 25687 **59⁹⁹** REG. \$79.99

- Heavy Duty 24 Tooth Pear Shaped Ratchet Head
- Audible Click When Desired Torque is Reached
- Both Clockwise and Counter-Clockwise Operation



Offer Good Through September 30, 2016 - While Supplies Last

SAVE \$10

3/8" Drive 25-250 In/Lbs. Range

SKU 133657 25685 **39⁹⁹** REG. \$49.99

- 45 Tooth Round Head Ratchet
- Audible Click When Desired Torque is Reached
- Both Clockwise and Counter-Clockwise Operation



3/8" Drive 10-100 Ft/Lbs. Range

SKU 133658 25686 **39⁹⁹** REG. \$49.99

Offer Good Through September 30, 2016 While Supplies Last



Torque Wrenches

1/2" Drive Digital Torque Adapter

SKU 900805 25682 **59⁹⁹**

- Range 40 - 200 N-M (29.5-147.5 Ft/Lbs.)
- Buzzes When Target Torque Is Reached



3/8" Drive Digital Torque Adapter

SKU 362559 25684 **49⁹⁹**

- Range 27 - 135 N-M (238.9-1,194.8 In/Lbs.)

Turn Any Ratchet or Breaker Bar into a Digital Torque Wrench!

OEM TOOLS



1/4" Drive Torque Screwdriver

SKU 695088 33627172 **79⁹⁹**

- Range: 10 - 50 In/Lbs.
- Great for Low Torque Applications
- Easy-to-Read Window Scale



3/4" Drive Torque Multiplier

SKU 191056 25683 **299⁹⁹**

- Increase Torque Output
- It Utilizes a 3:1 Ratio Planetary Gear Set to Convert Low Torque (Max. 650 Ft/Lbs.) to High Torque (2,200 Ft/Lbs. / 3,000 N-M) for Heavy Duty Tightening or Loosening. Input Drive 3/4", Output Drive 1"
- Comes with a 3/4" Drive 2 Way Quick Release Ratchet



3/4" Drive Torque Wrench

100-600 Ft/Lbs. Range
SKU 217376 25688 **349⁹⁹**

- Right Hand Direction



Micrometer Click Style

3/4" Torque Wrench

SKU 850046 33627309 **349⁹⁹**

- Increase Torque Output
- Range: 86-410 Ft/Lbs.
- Torques in Both Directions
- Positive Lock with Spring-Loaded Pull Down Lock Ring
- Torques in Both Directions



Great for 2004-2008 Ford F150 Brake Rotor and Hub Assembly Replacement

Sensor Sockets

Oil Pressure Switch Socket

SKU 141490 25254 **11⁹⁹**

- Fits Most 1" and 1-1/16" Switches
- Accepts Oil Pressure Sending Units Up to 2-5/8" Long



3/8" Drive Oxygen Sensor Socket

SKU 047738 25001 **12⁹⁹**

- For Use with 3/8" Drive Ratchet or 1" Wrench
- Removes and Installs Oxygen Sensors On All Domestic and Imported Computerized Engine Controlled Vehicles
- Cutaway Slot Provided in the Si



Water Sensor Wrench Fits Aftermarket Sensors

SKU 459101 LIS34910 **16⁹⁹**

- Removes and Installs the Aftermarket Water Sensor Located On the Fuel Filter On 2001 through 2011 6.6L Duramax Diesel Engines



Water Sensor Wrench

SKU 459099 LIS34900 **16⁹⁹**

- Removes and Installs the Water Sensor Located On the Fuel Filter On 2012 and Newer 6.6L Duramax Diesel Engines



Oxygen Sensor Wrench

SKU 947305 33625246 **29⁹⁹**

- Use with Oxygen Sensors On Ford 4.6 and 5.4 Engines
- 7/8"/22 mm Used in SUVs and Light Trucks



Oxygen Sensor Socket Set

SKU 695125 33627110 **25⁹⁹**

- Universal Slotted Socket to Service Hex Vacuum Switches and Oxygen Sensors
- 3/8" and 1/2" Drive, 22 mm / 7/8"



IPR Socket

SKU 080593 LIS86210 **29⁹⁹**

- Used to Remove and Replace the Injector Pressure Regulator (IPR) On Ford 6.0L and Other Diesel Engines
- Designed to Bottom Out On the Hex So It Does Not Put Torque On the Connector in Case It Can Be Reused



7 Piece Sensor Socket Set

SKU 900823 27189 **59⁹⁹**

- For Removal and Installation of Hard to Reach Oxygen Sensors, Oil Pressure Switches, Oil Pressure Sending Units and Thermal Sensor Switches



Measuring Tools

Feeler Gauge

SKU 001927 25025 **6⁹⁹**

- 26 Blades with Laser Etched In/mm



X-Tread Digital Tire Gauge

SKU 186495 FOW74225500 **22⁹⁹**

- For Tire Tread Thickness Measurement
- Reads in Inch, Metric and Fractions



Electronic Digital Caliper

SKU 864649 25363 **29⁹⁹**

- Large Easy-to-Read LCD Display
- Zeroing Feature
- Thumb Roller with Locking Device



Disc Brake Rotor Micrometer

SKU 607071 25367 **49⁹⁹**

- .001" Accuracy, .0005" Reading
- Large LCD Display with SAE or Metric Reading
- Manual Power Off/On



Dial Indicator Set

SKU 186500 FOW72522101 **69⁹⁹**

- Includes 1" Indicator, Magnetic Base Plus Rods, Swivel Clamp and Case
- 2-1/4" Dial, .001" Increments



RotoCal® with Twin Conical Anvils

SKU 186492 FOW74150004 **74⁹⁹**

- Range 0 to 5.5"
- Reads in Inch, Metric and Fractions
- 3.5" Jaw Depth for Large Rotors



Mini MAG Protractor

SKU 186501 FOW744224501 **79⁹⁹**

- Embedded Magnets with 35 Lbs. Pull
- Uses Standard 9V Battery
- 360 Degree Measuring Range
- Accuracy +/- 2 Degrees



Disc Brake/Ball Joint Gauge

SKU 186496 FOW72520757 **99⁹⁹**

- Checks Ball Joint Wear and Disc Rotor Run-Out
- Checks Gear Backlash and Valve Guide Wear
- 0 to 1" Travel and .001" Graduations



Magnetic Angle Finder

SKU 042343 CEN6494A **22⁹⁹**

- Magnetic Base
- 1/2 Degree Graduations



Rotor/Drum Measuring Kit

SKU 186504 CEN3K301 **79⁹⁹**

- Attaches to Any Caliper On the Lower Jaws
- Outward Facing Anvils to Inspect Drums
- Inward Pointing Anvils to Measure Rotors
- 8 to 13" Range
- 0 to 6" Digital Caliper Included

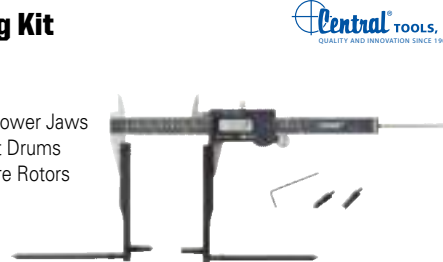

Straight Edge 24"x1/4"

SKU 404660 CEN6429 **119⁹⁹**

- Measure Head, Block and Flywheel Straightness
- Precision Ground to +/- .001"



3 Piece Micrometer Set

SKU 186503 CEN3M113 **139⁹⁹**

- 0 to 3" Range
- 0 to 1" 3m101, 1 to 2" 3m102, 2 to 3" 3m103
- Set Includes Calibration Tools





Contact Us:
1-877-AZTool1 Phone
 (1-877-298-6651) *Hablamos Español*

Harmonic Balancer

Harmonic Balancer Puller Retrofit Kit for GM

SKU 695100
33627296 **13⁹⁹**

- Use with OEM 33627019, 27019 and 25053 Harmonic Balancer Pullers and Many Other Popular Balancer Pullers
- The 3 Bolts Fit Through the Slotted Holes in the Balancer and Screws into the Threads of the Balancer On GM 3300 and 3800 V6 Engines
- Shoulders on the Bolts Prevent Damage to the Crank Sensor that Can Occur When Using Standard Bolts
- Includes Spacer to Prevent Damage to Crankshaft and Threads



OEM TOOLS

Harmonic Balancer/Steering Wheel Puller

SKU 532440
25053 **17⁹⁹**

- Removes Balancers, Steering Wheels, Pulleys and/or Gears with Tapped Holes
- Floating Swivel Helps Prevent Damage to Shaft End
- 4 Slots in Yoke, Use for 2 or 3 Hole Applications with 3/8"-24, 5/16"-18 and 3/8"-16 Bolt Sizes



OEM TOOLS

Harmonic Balancer Puller Kit

SKU 818738
25090 **49⁹⁹**

- Includes: Puller Body, 3 Jaw Puller, (3) Jaw Retaining Pins, (3) Wave Washers, Pressure Screw
- Insert Rods: 4", 5-13/32", 6-1/2" and 7-13/32"
- Used On Many GM, Mitsubishi and Chrysler Engines



OEM TOOLS

Unique jaw and returning springs for easy positioning of the puller

19mm Harmonic Balancer Socket for Honda

SKU 011632
LIS77080 **29⁹⁹**

- More than 3 Time Standard Socket Mass
- For use with 19mm Applications
- Made with Heat-Treated, Alloy Steel



Risle

Alternator

Alternator Decoupler Pulley Tool Kit

SKU 300124
27261 **24⁹⁹**

- Set Works On Both Overriding Alternator Decoupler (OAD) and One-Way Clutch (OWC) Pulleys
- Tools May Be Used While the Alternator Is On or Off the Vehicle
- Comes in a Blow Mold Case



OEM TOOLS

Alternator Decoupler Tool Set

SKU 255865
LIS57650 **34⁹⁹**

- Five Piece Kit for Removing and Installing Many Alternator Decoupler Pulleys on the Most Popular Vehicles in North America
- Comes in a Blow Mold Case



Risle

Alternator Decoupler Pulley Service Kit

SKU 695085
33627275 **60⁹⁹**

- Allows Alternator Shaft to Be Held While the Pulley Retainer Is Removed
- Includes: A Special Set of Spline and Star Socket Bits for a Removal of Bosch Type Alternator Free-Wheel Drive Pulleys



OEM TOOLS

Pullers

2 Jaw 5 Ton Gear Puller

SKU 141513
25914 **29⁹⁹**

- Reversible
- Maximum Reach: 3-1/4"
- Maximum Spread: 6"



2/3 Jaw 2 Ton Gear Puller

SKU 070134
25901 **34⁹⁹**

- Maximum Reach: 3-1/2"
- Maximum Spread: 4-3/4"
- Center Forcing Screw: 3/8" to 24" x 4-7/8"



2/3 Jaw 5 Ton Gear Puller

SKU 231202
25919 **39⁹⁹**

- Reversible
- Maximum Reach: 5-1/2"
- Maximum Spread: 7"



Bearing and Pulley Puller Set

SKU 900824
27190 **89⁹⁹**

- Use On Pitman Arms, Timing Gears, Carrier Side Bearings, Crankshaft Pulleys and More

OEM TOOLS



Makes up to Eighteen different pullers!

Specialty Pullers

Steering Wheel Puller Leg Kit

SKU 793567
33627312 **10⁰⁰**

- Steel Construction for Durability
- Includes (2) J Hook Puller Legs
- Use with OEM 27017 Steering Wheel Puller and Other Popular Pullers



Steering Pivot Pin Remover

SKU 265106
25135 **14⁹⁹**

- Works On 1969 to Current GM, Chrysler and Ford Vehicles with Saginaw Steering Columns



Timing Gear and Pulley Set

SKU 695623
33627009 **16⁹⁹**

- Services Crankshaft Pulleys and Timing Gears On Gasoline and Diesel Powered Engines



Harmonic Balancer Puller

SKU 695619
33627019 **20⁹⁹**

- Set Includes: Yoke, Pressure Screw, and Pulling Screws
- Floating Swivel Prevents Damage to Shaft Ends
- Comes in a Sturdy Blow Mold Storage Case
- Yoke Features 4 Slots
- Heat-Treated for Strength and Durability.



OEM TOOLS

Power Steering Pulley Puller/Installer Kit

SKU 141495
25298 **32⁹⁹**

- Fits Pulleys with Hub Diameters Measuring 1-1/8", 1-1/4", 1-5/16" and 1-3/8"



Steering Wheel and Lock Plate Puller Kit

SKU 900821
27182 **49⁹⁹**

- Used to Pull Steering Wheels On Many Major Makes of Automobiles
- Includes Yoke, Pressure Screw and Five Sets of Pulling Screws with Washers and Swivel



VW®/Audi® Diesel Injector Puller Kit

SKU 548566
27282 **59⁹⁹**

- Remove Diesel Injectors from 1996 to Current VW and Audi Vehicles
- Applications: VW, Audi TDI Engine



SAVE \$20

Long Reach Harmonic Balancer Pulley Installer

SKU 544785
24442 **39⁹⁹** REG. \$59.99

- Install Crank Pulley On Many Late Model Ford, GM, Dodge and Chrysler Vehicles with V8 and V6 Engines
- Includes: M16x2.0 - GM; M14x1.5 - Dodge, Chrysler, Jeep; M12x1.75 - Dodge, Chrysler, Jeep; M112x1.5 - Ford; Nut / Bearing Assembly



Offer Good Through September 30, 2016 While Supplies Last

Fuel

Fuel Pump Module Spanner Wrench

SKU 110278
25156 **24⁹⁹**

- Removes and Installs the Fuel Pump Retaining Ring



Slide Hammer Pullers

9 Way Slide Hammer Puller Set

SKU 900825
27191 **99⁹⁹**

- Pulls Flange Type Rear Axles and Most Front Wheel Drive Hubs
- Internal and External Jaws Provide a Variety of Combinations to Pull Bearings, Gears and Seals
- Two and Three-Way Cross Blocks
- Set Also Includes a Grip Wrench Adapter and a Dent Puller Attachment
- Designed for Use with Other 5/8" - 18 Thread Slide Hammer Attachments



Blind Hole Puller Set

SKU 695118
33627128 **160⁹⁹**

- Pull Blind Hole Bearings, Bushings and Sleeves with Inside Diameters 3/8" - 1-3/8"

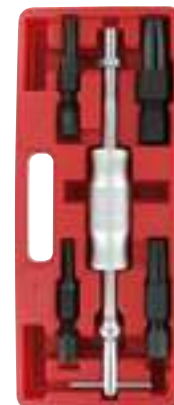

OEM TOOLS

SAVE \$20

Fuel Tank Lock Ring Tool

SKU 751721
24398 **39⁹⁹** REG. \$59.99

- For 2004 - Newer Ford F150 Trucks; 2004 or Newer Chrysler/Dodge Mini-Vans, PT Cruiser, Dakota, Durango; 2004 Newer Chevy 1/2 Ton and 3/4 Ton Trucks
- Works with 1/2 Drive Ratchet or Breaker Bar



Offer Good Through September 30, 2016 While Supplies Last

Power Steering

Air Bleed Adapter for Ford

SKU 751704
MITMVA662 **29⁹⁹**

- Helps Remove Trapped Air in the Power Steering System
- Seals Ford Power Steering Pump Necks Having an Internal Diameter of 1-1/4" or 2" (32 or 50 mm)
- Works with a Hand Vacuum Pump



Air Bleed Adapter for GM

SKU 751698
MITMVA661 **29⁹⁹**

- Helps Remove Trapped Air in the Power Steering System
- Designed for Sealing GM Power Steering Pumps with a Two-Tab Cap Design
- Works with a Hand Vacuum Pump



Universal Air Bleed Adapter

SKU 751699
MITMVA660 **24⁹⁹**

- Helps Remove Trapped Air in the Power Steering System
- Rubber, Cone-Shaped Design
- Seals Pump Necks Ranging from 5/8" Up to 1-5/8" (16 Up to 41 mm) Internal Diameter
- Works with a Hand Vacuum Pump



90 Degree Air Bleed Adapter

SKU 751710
MITMVA665 **24⁹⁹**

- Available Separately and Can Be Interchanged with the In-Line Connector On MVA661 and MVA662
- For Applications with Limited Overhead
- Works with a Hand Vacuum Pump



Power Steering Vacuum Pump

SKU 463254
THX212 **159⁹⁹**

- Bleeds Trapped Air from Power Steering System
- Tapered Adapter Allows Use On Most Makes and Models



THEXTON

SERVICE TOOLS



Contact Us:
1-877-AZTool1 Phone
 (1-877-298-6651) *Hablamos Español*

Tubing

Mini Tubing Cutter
 SKU 532507
 25058 **8⁹⁹**

OEM TOOLS



- STORE STOCK**
- Capacity: 1/8" to 7/8"
 - Cutter Is Capable of Turning On a 1-7/8" Radius
 - Lightweight for Easy Handling

Tubing Cutter
 SKU 141489
 25299 **7⁹⁹**

OEM TOOLS



- STORE STOCK**
- Cuts Tubes Capacity: 1/8" to 1-1/8"
 - Two Facing Flare Groove Rollers
 - Die Cast Frame with Reamer
 - Alloy Steel Cutting Wheel
 - Large, Easy Grip Knob with 1/8" to 1-1/8" 2 Facing Flare Groove Rollers

Multi-Purpose Tubing Bender
 SKU 390889
 25179 **14⁹⁹**

OEM TOOLS



- STORE STOCK**
- Works On 3/16", 1/4" and 3/8" (4, 6, and 8 mm) O.D. Copper, Aluminum and Stainless Steel Tubing
 - Used to Make Left, Right and Offset Bends Up to 90 Degrees

SAVE \$18

Ratcheting Tubing Cutter

OEM TOOLS

SKU 466309
 24520 **19⁹⁹** REG. \$37.99

- STORE STOCK**
- Ratcheting Action Ideal Where Space Is Limited
 - Cuts 1/4" to 1-1/8" Tubing



Offer Good Through September 30, 2016
 While Supplies Last

In-Line Flaring Tool Kit

OEM TOOLS

SKU 238197
 24364 **24⁹⁹**

Create a Perfect Flare Every Time!

- STORE STOCK**
- Use On Thin Walled Steel and Copper Tubing
 - Low Profile Design Allows for Use On or Off the Vehicle
 - 3/16" and 4.75 mm Tubing
 - Double Clamp and Hex Screw Keeps Tubing Locked Tightly in Position



Double Flaring Tool

OEM TOOLS

SKU 695622
 33627015 **30⁹⁹**

- Produces Single and Double Flares in Soft Steel



Tubing Bender Pliers

SKU 265107
 25170 **34⁹⁹**

- Bends All Types of 3/16" Brake Lines and 1/4" OD Tubing without Kinking or Flattening, Especially in Tight Spots



Die and Adapter Flare for GM Transmission Cooling Line

Mastercool
"World Class Quality"

SKU 300785
 MSC71099-TC **49⁹⁹**

- Die and Adapter Flare for GM Transmission Cooling Line



Universal Hydraulic Flaring Tool Set

Mastercool
"World Class Quality"

SKU 390927
 MSC71475 **439⁹⁹**

- Fabricates Push to Connect Flares: 1/4", 5/16" and 3/8"
- GM Fuel Line Flares: 5/16" and 3/8"
- Double Flares: 3/16", 1/4", 5/16", 3/8" and 1/2"
- Metric Bubble Flares: 4.75, 6, 8 and 10 mm



Double Flaring Tool
 SKU 864647
 25358 **21⁹⁹**

OEM TOOLS

- STORE STOCK**
- Includes Five Adapters: 3/16", 1/4", 5/16", 3/8" and 1/2" (4.8 mm Through 12.7 mm)



Exhaust Tools

Exhaust Manifold Spreader Set

OEM TOOLS

SKU 504028
 25253TWO **22⁹⁹**

- Used for Reinstalling the Manifold On Small Block Chevrolets
- Simple Way to Expand a Warped Manifold So All Bolt Holes Are Accurately Aligned
- Helps Prevent Cross-Threading of Manifold Bolts
- Works Best When Used in Pairs or Install Before Removing Manifold to Prevent Mis-Alignment



Tailpipe Cutter

OEM TOOLS

SKU 695599
 33627045 **50⁹⁹**

- Used to Cut Tailpipe
- Range 3/4" to 3 - 1/4" (19 - 83 mm)



Pipe Stretcher Kit

Leak

SKU 080137
 LIS17350 **274⁹⁹**

- Expands All Types of Exhaust Pipe, Including Stainless Steel, from 1 - 5/8" to 4 - 1/4" in Size
- Use with Impact Wrench to Quickly Stretch Pipes
- Collet Sets Expand Pipes from 1-5/8" to 4-1/4"



Thread Repair

Nes
The Thread Repair Experts

2 Piece External Thread Repair Set 5/32" - 1.1/2"

SKU 343361
 NES1000* **199⁹⁹**

- Includes the NES1A and NES2
- Restores Inch or Metric, Right or Left Handed Fastener Threads



*NES Set Comes with Extra Blades

External Thread Repair 5/32" - 1/2"

SKU 343360
 NES6040 **39⁹⁹**

- Restores Inch or Metric, Right or Left Handed Fastner Threads



External Thread Repair 5/32" - 11/16"

SKU 343365
 NES1A **74⁹⁹**

- Also Repairs Damaged Threads On Pipes up to 7/16"



External Thread Repair 11/16" - 1 - 1/2"

SKU 343366
 NES2 **104⁹⁹**

- Restores Inch or Metric, Right or Left Handed Fastner Threads



Internal Thread Repair

5/16" - 7/16"
 SKU 343367
 NES21 **84⁹⁹**

1/2" - 5/8"
 SKU 343369
 NES22 **84⁹⁹**

- Restores Inch or Metric, Right or Left Handed Fastner Threads



Scan the QR Code for More Info On NES Thread Repair Products

Thread Chasers

OEM TOOLS

Spark Plug Hole Thread Chaser

SKU 070109
 25124 **6⁹⁹**

- STORE STOCK**
- Double End for 14 mm and 18 mm
 - For Use with 13/16" Deep Sockets
 - Cleans Spark Plug Threads of Dirt and Carbon Build-Up



Limited Access Spark Plug Chaser

OEM TOOLS

SKU 607068
 25155 **12⁹⁹**

- STORE STOCK**
- Narrow Profile and Long Length Allows Access to Spark Plug Holes in Confined Spaces
 - Use with a 3/8" Ratchet or Extension
 - Size: M14 x 1.25



Oxygen Sensor Thread Chaser

OEM TOOLS

SKU 607067
 25255 **13⁹⁹**

- STORE STOCK**
- Use with 3/8" Hex Socket or 3/8" Square Drive
 - Size: M18 x 1.5



Spark Plug Installation

Heavy Duty Spark Plug Boot Pliers

SKU 390900
 25542 **9⁹⁹**

- STORE STOCK**
- Designed to Remove Hard-to-Reach Spark Plug Boots
 - Has 45 Degree Offset Jaws for Easy Gripping of Wires and Boots
 - Vinyl Coated Grips for Comfort
 - Do Not Use When the Engine Is Running

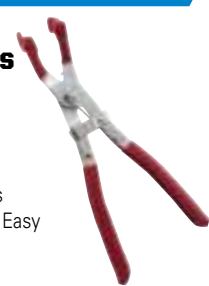

3/8" Drive 9/16" Spark Plug Socket

OEM TOOLS

SKU 265110
 25259 **22⁹⁹**

- 10" Long with Thin Wall Design to Reach in to the Cylinder Head
- Fits 2004-Newer Ford F-150 Pick-Up Trucks with 5.4L 3 Valve Triton V-8 Engines
- Chamfered Ends
- Chrome Plated to Resist Rust



SCHRADE

colorshift

- Assisted Open, Finger Actuator
- 2.9" 4034 Stainless Steel Blade
- 4.4" Colorshift® Aluminum Handle

SKU 452991
 SCHA3CBS **63⁹⁹**

*Products advertised may be considered illegal and may not be lawful to sell, purchase or own in specific areas.



M&P
 by Smith & Wesson

M.A.G.I.C. KNIFE

- Assisted Open, 40% Serrated
- 3.4" 4034 Stainless Steel Blade
- 4.3" Aluminum Handle

SKU 452998
 SWMP6S **63⁹⁹**

*Products advertised may be considered illegal and may not be lawful to sell, purchase or own in specific areas.



DID YOU KNOW?

AutoZone has instrument clusters available.

Contact Your AutoZone Commercial Sales Manager for Details

THREAD REPAIR

Spark Plug Thread Repair

14 mm Tapered Spark Plug Thread Repair Kit

SKU 141511
25647 **29⁹⁹**

STORE STOCK

- Can Be Used to Repair Both Taper Seat and Gasket Type Spark Plug Assemblies
- Three Insert Lengths Are Available to Accommodate Most Spark Plug Reaches
- Positive Mechanical Locking Feature Means the Insert Will Never Come Out
- The Piloted Reamer Tap Means No Drilling Is Necessary and Perfect Alignment of the Tapped Hole

14 mm Tapered Spark Plug Inserts

SKU 141512
25648 **11⁹⁹**

STORE STOCK

- 6 Pieces in Three Lengths M14 - 1.25
- Drill Size: 14.25 mm; 9/16"

M14 - 1.25 Spark Plug Thread Repair System

SKU 557108
25643 **29⁹⁹**

STORE STOCK

- Replaces Threads for 14 mm Spark Plug
- Kit Includes: 3 Thread Inserts, Thread Installer Tool and Thread Tap
- Sizes: M14 - 1.25
- Not for Tapered Spark Plugs

M12 - 1.25 Spark Plug Thread Repair Kit

SKU 789141
25640 **44⁹⁹**

- Kit Includes: 3 Thread Inserts, Thread Installer Tool and Thread Tap
- Designed for Rethreading in All Materials Such As Alloys, Steels, Plastics, Magnesium, etc.
- Specified for Military, Aviation and Other Critical Usage
- Inserts Are Made from High Quality 18-8 Stainless Steel Wire with a Diamond Shaped Cross Section Wound to the Shape of a Spring Thread
- Not for Tapered Spark Plugs

Drain Plug Repair

Drain Plug Repair Kit

SKU 818569
CAL38400 **79⁹⁹**

- Designed to Repair Aluminum Oil Pans with Damaged Drain Plug Threads Size M12 x 1.75 Commonly Found in GM, Ford and Mazda Vehicles
- Drain Plug Repair Kit Contains a Drill, Counter Bore, Tap, Driver, Guide and (5) 12 mm Inserts
- Repairs Stripped Drain Plugs without Leakage and Allows Users to Use Original Plug Instead of a Replacement

Thread Repair

3 Piece Internal/External Thread Repair Set

SKU 343362
NES1015 **249⁹⁹**

- Includes the NES1A, NES21 and NES22 Restores Inch or Metric, Right or Left Handed Fastener Threads

Oxygen Sensor Thread Repair Kit

SKU 010134
FIX38189-1 **99⁹⁹** **NEW**

- No Need to Replace Exhaust Manifold
- Pilot Nose Tap Provided
- Easy and Quick to Use, Repairs in Minutes

Metric Head Bolt Thread Repair Kit

SKU 010131
FIX35119S **149⁹⁹** **NEW**

- Applications - Cadillac®, Honda®, Toyota® and Other Imports
- Extended Reach for Deep Threads
- Longer Length (33 mm) Inserts for Maximum Thread Engagement

Metric Thread Repair Kits

*STORE STOCK

SKU	Part No.	Size	Price	SKU	Part No.	Size	Price
516472*	25626	M6 - 1	29.99	516473*	25627	M6 - 1	6.99
516474*	25628	M8 - 1.25	29.99	516475*	25629	M8 - 1.25	7.99
516477*	25632	M10 - 1.5	29.99	516478*	25633	M10 - 1.5	7.99

SAE Thread Repair Kits

*STORE STOCK

SKU	Part No.	Size	Price	SKU	Part No.	Size	Price
557009*	25602	UNC 1/4" - 20	22.99	557116*	25603	UNC 1/4" - 20	6.99
557017*	25604	UNC 5/16" - 18	22.99	557124*	25605	UNC 5/16" - 18	6.99
557090*	25606	UNC 3/8" - 18	22.99	557132*	25607	UNC 3/8" - 16	7.99
516464*	25608	UNC 7/16" - 14	29.99	516465*	25609	UNC 7/16" - 14	7.99
516467*	25610	UNC 1/2" - 13	29.99	516468*	25611	UNC 1/2" - 13	9.99

Replacement Inserts

*STORE STOCK

Drill Bits and Extractor Sets

6 Piece Spiral Flute Screw Extractor Set

SKU 099277
24374 **14⁹⁹**

- Extractors: Ex-1, Ex-2, Ex-3, Ex-4, Ex-5 and Ex-6
- M2 Steel
- Comes in a Vinyl Pouch

10 Piece Multi-Spline Screw Extractor Set

SKU 099281
24375 **39⁹⁹**

- Contains Sizes from 1/8" - 13/32" in 1/32" Increments
- Can Be Used with Hand Sockets and Wrenches
- Constructed of High Carbon Steel for Strength Under Stressful Conditions
- Aggressive Left Hand Spiral Design Provides Extra Gripping Power

10 Piece Bolt Extractor Set

SKU 231204
25467 **19⁹⁹**

STORE STOCK

- (5) Mechanic's Length L.H. Cobalt Drill Bits
- Set Includes Extractors Size: #1, #2, #3, #4, #5 and Bits: 5/64", 7/64", 5/32", 1/4" and 19/64"

35 Piece Master Screw Extractor/Drill Bit Set

SKU 099258
24377 **149⁹⁹**

- Full Range of Spiral and Multi-Spline Extractors for Removing the Toughest Bolts and Screws from 3/32" to 15/16"
- OEM 135° Split Point Left Hand Cobalt Drill Bits, Start Easy and Drill the Toughest Metals

25 Piece Screw Extractor/Drill and Guide Set

SKU 099215
24376 **39⁹⁹**

- Can Be Used On Thread Sizes 5 mm to 16 mm
- Turns Broken Fastener Out and Permits Highest Torque without Expansion
- Comes in a Blow Mold Case

5 Piece Double Edge Bolt and Screw Extractor Set

SKU 042353
KNP9R4719043 **59⁹⁹** **NEW**

- Contains Sizes 1-5 in a Plastic Tube
- Tip Has Built-In Center Punch
- No Additional Tool Required

3 Piece Double Edge Bolt and Screw Extractor Set

SKU 042367
KNP9R4719033 **29⁹⁹** **NEW**

- Contains Sizes 1-3 in a Plastic Tube
- Tip Has Built-In Center Punch
- No Additional Tool Required

SAVE \$15

10 Piece Spiral Extractor and Drill Bit Combo Pack

SKU 099229
24373 **24⁹⁹** REG: \$39.99

- Extractors: Ex-1, Ex-2, Ex-3, Ex-4 and Ex-5
- Left Hand 135 Degree Split Point Cobalt
- Drill Bit Sizes: 5/64", 7/64", 5/32", 1/4" and 19/64"
- Aggressive Left Hand Spiral Design for Extra Gripping Power
- 135 Degree Split Point Left Hand Drill Bits Cut Through the Toughest Metal
- Pilot Point Starts on Contact and Eliminates Bit Walking
- Comes in a Vinyl Pouch

Offer Good Through September 30, 2016 While Supplies Last

Spark Plug Thread Repair for Ford Triton

Ford Spark Plug Porcelain Extractor Set

SKU 104290
24202 **29⁹⁹**

- Use to Extract the Broken Porcelain from Broken Spark Plugs in 2003 to Current Ford Triton Engines
- In Some Cases the Porcelain Will Break Off in the Sleeve and Will Need to Be Extracted in Order for the 24201 to Function Effectively
- Unlike Other Tools that Tell You to Push the Porcelain Through the Sleeve (Ford Says Specifically Not to Do this) this Tool Adheres to the Porcelain Using a Special Adhesive and Then Allows a User to Extract the Broken Porcelain from the Sleeve

Loctite 60800 5 mL Replacement Adhesive

SKU 248475
24204 **15⁹⁹**

Replacement Pins

SKU 248476
24205 **16⁹⁹**

Ford Spark Plug Extractor Set

SKU 104286
24201 **84⁹⁹**

- Works to Extract Frozen and Broken Off Spark Plug Sleeves in 2004 to Present Ford Triton Engines
- Specially Machined Guide Works with Extra Long Tap and Extractor to Make Sure the Job is Done Right

Ford Triton Plug-Saver® Kit

SKU 094873
FIX98140T **149⁹⁹**

- Designed to Specifically Repair the Spark Plug Ports in 4.6, 5.4 and 6.8 Ford Triton Engines
- Repairs Worn, Damaged Threads
- Self Cutting Tap
- Includes Tap, Tool and Eight Inserts in a Sturdy Case

Broken Spark Plug Remover Ford Triton 3 Valve

SKU 489173
LIS65600 **99⁹⁹**

- Includes a Unique Porcelain Pusher Tool and a Tapered Left Hand Thread Remover for Removing the Broken Spark Plug without Leaving the Porcelain in the Engine Cylinder

Inserts (Pack of 8)

SKU 110263
FIX98149P **27⁹⁹**

Ford Cylinder Repair Set

SKU 104283
24200 **259⁹⁹**

Comes with Instructional Video

- Repair of Ford Triton Modular Engines Is Going to Be a Large Issue in Next 5 Years. Ford Triton Engines 1996 - 2003 Have a Problem with Spark Plug Thread Erosion, Resulting in Spark Plug Threads Coming Out During Tune-Up or Shooting Spark Plugs Out During Operation
- Current Repair Takes About 10 Labor Hours, this Tool Cuts Time to 30 Minutes to an Hour
- Works On Ford 4.6, 5.4, 6.8 V10 Engines
- Individual Inserts Available As Part Number 24203. The Patented Replacement Insert Is a Permanent Fix that Does Not Have to Be Replaced with Every Tune-Up
- Patented Guide Makes Drilling and Tapping in a Straight Line Easy
- Set Includes: Instruction Sheet, DVD, (6) Inserts, Reamer Tap, Drill Bit, Expanding Tool and Air Blower Accessory Assembly

Ford Triton 14 mm x 1.25 Repair Insert

SKU 104287
24203 **34⁹⁹ ea**

- Alloy Steel Insert - Not Aluminum
- Seals Perfectly and Prevents Any Loss of Compression
- Taper On the Inside of the Insert That Seats the Spark Plug

Ford Triton 16 mm x 1.5 3 Valve Insert

SKU 396658
CAL393-100 **22⁹⁹ ea**

- Note: THIS IS NOT the Replacement Insert for the Triton 2 Valve Kit

Ford Triton 3 Valve Set

SKU 343388
CAL39300 **299⁹⁹**

- Application: 2004-2008 Ford 4.6 and 5.4 3 Valve Engines that Have Spark Plugs that Are M16 x 1.5
- Includes (8) Inserts

SPECIALTY TOOLS

Lockout Tools

BigEasy™ Loop

SKU 964492
STK32903 **17⁹⁹**

- Clips to Any BigEasy to Allow Grabbing of Door Handles and Locks, It Even Glows in the Dark
- Provide Easy Leverage to Pull Door Handles and Window Cranks During the Door Unlocking Process
- Handy Accessory Tool Easily Snaps On the End of the BigEasy Tool Avoiding Need to Purchase Additional, More Costly Specialty Tools



BigEasy™ Carrying Case

SKU 227873
STK32935 **29⁹⁹**

- Made of Soft, Yet Firm, Material to Protect Your BigEasy Kit
- Custom Pockets for the BigEasy, Non-Marring Wedge, Lock Knob Lifter and Easy Wedge
- Makes it Convenient to Stow Your BigEasy Kit in Your Truck



BigEasy™ Easy Wedge (Inflatable)

SKU 964493
STK32922 **34⁹⁹**

- Inflatable Controlled Opening of Car Door for Insertion of the BigEasy



BigEasy™ Lockout Tools Kit

SKU 964491
STK32900 **39⁹⁹**

- High Visibility Pink Powder Coating and Improved Non-Marring Wedge
- Lock Knob Lifter for Cars with Flat Lock Knobs at the Top of the Door
- Paint Protector Reduces Friction Between the Car Door and the BigEasy



BigEasy™ Glo with Easy Wedge Lockout Kit

SKU 964494
STK32955 **74⁹⁹**

- Glow-in-the-Dark Yellow Allows You to See the Tool at Night or Through Tinted Windows
- Easy Wedge Offers Controlled Opening of the Car Door for Inserting the BigEasy Glo



Shop Tools

Angle Tip Lock Ring Pliers

SKU 191055
25354 **16⁹⁹**

- Jaws Are Scored On the Outside for Secure Gripping
- Spring Loaded Jaws
- Spread: 3/4"
- Length: 8-1/4"



Professional Snap Ring Plier Set

SKU 141502
25356 **16⁹⁹**

- 180°, 90° and 45° in One
- Tip Size: 0.8 mm, 1.2 mm, 1.4 mm, 2.0 mm



Snap Ring Pliers

SKU 011600
LIS46200 **24⁹⁹**

- Reversible Action for Both Internal and External Snap Rings
- Includes 4 Pairs of Tips
- 45 and 90 Degree Conical Tips

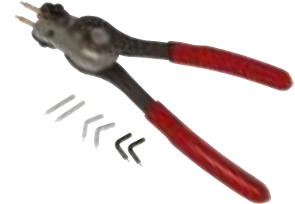

4 Piece 15" Jumbo Pick Set

SKU 094658
25940 **29⁹⁹**

- Includes: Straight, 90°, Offset and Hook Pick
- Chrome Vanadium Steel for Strength and Durability
- Black Oxide Finish to Resist Rusting
- Cushion Grip Handles



10 Piece Snap Ring Plier Set

SKU 900819
27180 **61⁹⁹**

- For Both Internal and External Rings
- Set Includes: 5-1/2" Bent Pliers with .038" Tip; 6" Straight Pliers with .038" Tip; 5-1/2" Bent Pliers with .047" Tip; 6" Straight Pliers with .047" Tip; 7-1/2" Bent Pliers with .070" Tip; 8" Straight Pliers with .070" Tip; 8-1/2" Bent Pliers with .090" Tip; 9" Straight Pliers with .090" Tip
- Also Includes Two Stainless Steel Handle Picks



Dead Blow Hammers

Professional Grade Quality

- One Piece, Hot Cast Polyurethane Construction
- Safety Red
- Maximum Dead Blow Non-Bounce Action
- Textured, Non-Slip, Comfort Contoured Handle

Dead Blow Sledge Hammers



Dead Blow Ball Pein

Dead Blow Hammers

SKU	Part #	Retail Name	Weight	Face Diameter	Head Length	Overall Length	Price	Sale Price
420347	TCHBP16	Ball Pein - 16	26 Oz.	1"	4.1875"	12.75"	39 ⁹⁹	35 ⁹⁹
420349	TCHBP24	Ball Pein - 24	36 Oz.	1.25"	4.5"	13"	44 ⁹⁹	39 ⁹⁹
420351	TCHBP32	Ball Pein - 32	47 Oz.	1.75"	4.8125"	13.625"	49 ⁹⁹	44 ⁹⁹
420352	TCHBP40	Ball Pein - 40	50 Oz.	1.75"	4.8125"	16.5"	59 ⁹⁹	53 ⁹⁹
420353	TCH7	Soft Face Sledge - 7	5.5 Lbs.	2.75"	7"	20"	59 ⁹⁹	53 ⁹⁹
420354	TCH14	Soft Face Sledge - 14	12 Lbs.	3.25"	8"	36"	129 ⁹⁹	116 ⁹⁹
420343	TCH1	Soft Face Hammer - 1	21 Oz.	1.75"	3.75"	11.25"	19 ⁹⁹	17 ⁹⁹
420344	TCH2	Soft Face Hammer - 2	26 Oz.	2"	4.125"	12.75"	24 ⁹⁹	22 ⁹⁹
420345	TCH3	Soft Face Hammer - 3	45 Oz.	2.25"	4.625"	14.375"	29 ⁹⁹	26 ⁹⁹
420346	TCH4	Soft Face Hammer - 4	53 Oz.	2.75"	5.375"	15.25"	44 ⁹⁹	39 ⁹⁹



3 Piece Dead Blow Hammer Set

SKU 900804
25517 **26⁹⁹**

- 1/2 Lbs. 1 Lbs. and 2 Lbs.
- Soft Rubber Handles for Non-Slip Grip
- Steel Shot Filled for More Force
- Non-Spark Material Used

Rivet Tools

Industrial Riveter

SKU 291353
25921 **49⁹⁹**

- For Use with Steel and Aluminum Rivets
- Noses: 1/8" (3.2 mm), 5/32" (4.0 mm), 3/16" (4.8 mm), 1/4" (6.4 mm)
- 18" Overall Size with Long Handle Provides More Leverage

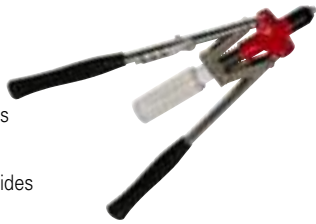

Deluxe Riveter Kit

SKU 094877
MAR39001KIT **39⁹⁹**

The Choice of Professionals

- Kit Includes: HP2 Riveter, (Sets Up to 3/16" Diameter Rivets), (200) Rivets and Molded Case
- 39003 Same as 39001 but Contains (200) Assorted Klik-Fast Stainless Steel Rivets



SKU 094879
MAR39003KIT **39⁹⁹**
Stainless Steel

KLIK-LOK Plastic Rivet Setter

SKU 222531
MAR48005 **59⁹⁹**

- Includes a Universal Nose Piece that Sets All Plastic Rivets



Big Daddy® Hand Riveter

SKU 094886
MAR39031 **139⁹⁹**

The Big Daddy is the Most Versatile and Powerful Hand Riveter. Sets Large Diameter Blind Rivets

- Double Gear Reduction System Easily Sets from 1/8" to 1/4" Diameter Klik-Fast Rivets in All Alloys Including 1/4" Klik-Split® Rivets
- Comes with 5/32", 3/16" and 1/4" Nose Pieces Stored in the Body



Air Over Hydraulic Powered Rivet Tool

SKU 222750
MARAK-175 **449⁹⁹**

- Sets 1/8" - 1/4" Steel Rivets with Up to 3,500 Lbs. of Pull Capacity
- Unique Jaw System Accommodates 1/8" - 1/4" Rivet Sizes by Simply Changing the Nose Assembly (No Tools Required)





Contact Us:
1-877-AZTool1 Phone
 (1-877-298-6651) *Hablamos Español*

Relay Tools

Relay Puller Pliers

SKU 291342 LIS46950 **23⁹⁹**

- Works On Many Heavy Duty and Industrial Applications
- Allows Relay to Pop Free from Socket with Less Chance of Damaging the Relay

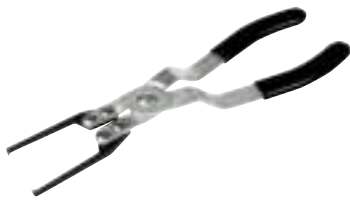

Relay Test Jumper Set II

SKU 291341 LIS60610 **74⁹⁹**

- Set Includes Four Jumpers to Fit Many Popular Relays on Honda, Nissan, Toyota, Newer Ford and GM Mini Micro Relays As Well As International Trucks
- Set Comes in Blow Mold Case for Storage



Relay Test Jumper Set

SKU 291333 LIS56810 **74⁹⁹**

- Set Includes Four Jumpers to Fit the Most Popular Size Relays On Domestic and Import Vehicles
- Jumpers Have Tabs for Clamping and Flat Pads to Place Test Leads On
- Set Comes in Blow Mold Case for Storage



Relay Circuit Tester

SKU 383450 LIS27211 **139⁹⁹**

- Includes: Tester, (5) Popular Relay Leads, (1) Universal Relay Lead
- Used to Test Relay Circuits in Late Model Vehicles
- Can Also Be Used to Perform Easy Combination Tests, Fuel Pressure Tests and Jump Relay for A/C Fill
- Set Comes in Blow Mold Case



Remote Starters

Remote Starter Switch

SKU 265124 LIS25330 **19⁹⁹**

- Heavy Clips with Insulated Sleeves Attach to Ground and Starter Solenoid Switch
- Thumb Activated Switch
- 6' Heavy Insulated Wire for Long Tool Life



Terminal Tools

Wire Terminal Tools

SKU 191676 LIS25228 (Green) **19⁹⁹**
 SKU 255953 LIS25229 (Red) **19⁹⁹**

- Fits Most GM and Domestic Motors, Computer Connectors and Terminals
- Designed to Remove Wires from Terminals without Damaging Either
- Prongs Depress the "Barbs" On Conventional Terminals

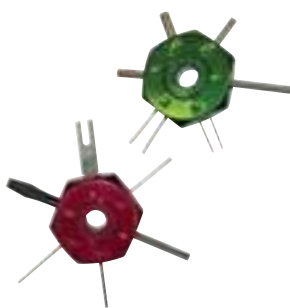

Deutsch Terminal Tool

SKU 222527 LIS59600 **32⁹⁹**

- Works On OEM Electrical Connectors Used On Trucks and Equipment: Caterpillar, Kenworth, Peterbilt, Freightliner, Mack and More

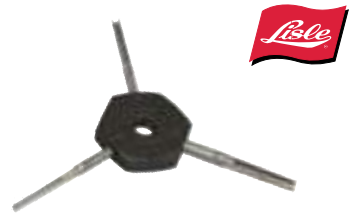

19 Piece Master Terminal Tool Kit

SKU 447159 LIS27169 **109⁹⁹**

- Latest Tools for Coolant Sensors, Wiring Harnesses and Terminal Blocks On Most Modern Vehicles
- Eliminates Potential Damage to Wires or Terminal Blocks
- Application Chart Included Inside Storage Case

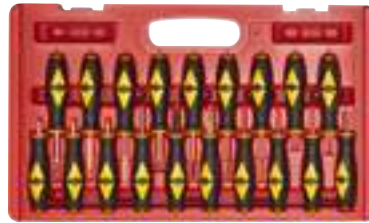

SAVE \$10

Heavy Duty Remote Starter Switch

SKU 265127 LIS25331 **29⁹⁹** Reg: \$39.99

- Heavy Duty, Push Button Remote Starter Allows Technicians to Bump or Crank Engines While Under the Hood
- 5' Heavy Insulated Wire for Long Tool Life
- Heavy Duty Insulated Alligator Clips



LED Indicator Light Shows Current is Present

Offer Good Through September 30, 2016 - While Supplies Last

SAVE \$20

Digital Display Circuit Tester

SKU 568468 LIS24451 **29⁹⁹** Reg: \$49.99

- Detect Voltage, Power, Ground and Circuit Condition
- Display Provides Precise Voltage
- Voltage: 5-30V DC
- Computer Safe - Do Not Use On Airbags



Offer Good Through September 30, 2016 - While Supplies Last

Wire Strippers/Crimpers

Wire Cutter/Stripper Combo

SKU 191685 LIS25192 (Small) **16⁹⁹**

- Used for Soft Copper, Electrical Wires
- Self-Adjusts to Wire Sizes: 14 AWG to 26 AWG
- Grab, Hold and Strip Wire in One Quick Motion
- Jaws Are Made of Surgical Steel



Circuit Tester

Computer Safe Circuit Tester

SKU 222515 LIS24550 **22⁹⁹**

- Indicates Polarity
- Draws Less Than 21 mA at 12 Volts DC
- Operating Range: 3 - 28 Volts



Radio Remover

Radio Remover

SKU 222508 LIS11770 **16⁹⁹**

- Disengages Radio Retaining Clips On Fords and Imports for Removal

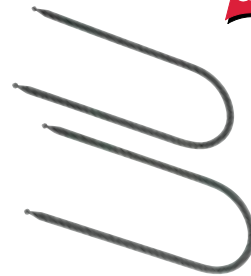

Ignition Tester

In-Line Ignition Spark Tester

SKU 900800 LIS25227 **8⁹⁹**

STORE STOCK

- Quickly Troubleshoot Ignition System
- "Hands-Free" Device Connects In-Line Between Sparkplug and Plug Wire
- Shows a Duplicate View of the Ignition Spark
- Technician Can Visually Check Condition of Ignition System at Each Cylinder



Wire Strippers

Compact 14-24 Gauge Wire Stripper

SKU 011610 LIS68250 **24⁹⁹**

- Cuts and Strips Insulation from 14 to 24 Gauge Wires
- Crimps 14 to 24 Gauge Terminals
- Wire Gauge Key Markings



NEW

Compact 8-14 Gauge Wire Stripper

SKU 011620 LIS68280 **24⁹⁹**

- Cuts and Strips Insulation from 8 to 14 Gauge Wires
- Crimps 8 to 14 Gauge Terminals
- Wire Gauge Key Markings



NEW

Fuse Buddies

3-in-1 Tester

Fuse Buddy Pro Tester Kit

SKU 374602 LIS3130 **89⁹⁹**

3 Interchangeable Test Functions:

1. 30 Amp MINI Circuit Amperage Testing
2. 30 Amp ATC Circuit Amperage Testing
3. 30 Amp All Purpose Amperage Testing

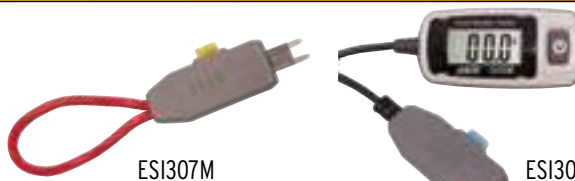

Fuse Buddy Current Loop Mini SKU 374610 **24⁹⁹**
Fuse Buddy Tester Mini 30 Amp SKU 374613 **29⁹⁹**
Fuse Buddy Tester ATC 30 Amp SKU 374603 **29⁹⁹**

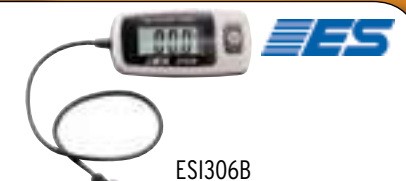

ES1307M **24⁹⁹**
 ES1305M **29⁹⁹**
 ES1306B **29⁹⁹**

SPECIALTY TOOLS

Disconnect Tools

4 Piece Disconnect Set

SKU 864648
25150

19⁹⁹

STORE STOCK

- Sizes: 1/4", 1/2", 5/16" and 3/8"



15 Piece Master Disconnect Set

SKU 900807
27195

39⁹⁹

- Includes Fuel and Transmission Line Disconnect Set, Oil Cooler Line Remover, Air Conditioning and Fuel Line Disconnect Tool



22 Piece Disconnect Master Set

SKU 900817
27177

79⁹⁹

- Includes Quick Connects Set, Air Conditioning and Fuel Line Disconnect Tools



A/C and Fuel Line Disconnect Tool Set

SKU 246366
25042

7⁹⁹

STORE STOCK

- Range: A (3/4"), B (5/8"), C (1/2") and D (3/8")



Fuel Line Disconnect Tool

SKU 246367
25043

7⁹⁹

STORE STOCK

- Fits Any 5/16" or 3/8" Fuel Line Found On GM, Ford and Chrysler Vehicles



A/C and Fuel Line Quick Connect Tools

SKU 002356
25052

9⁹⁹

STORE STOCK

- Easily Disconnects Air Conditioning Lines and Quick Connect Fuel Lines



Quick Connect Tools

SKU 363869
25184

12⁹⁹

STORE STOCK

- Sizes: 3/8", 1/2", 5/8" and 3/4"
- Enables Quick and Easy Disconnect of Air Conditioning Couplings



3 Piece 1/2" Oil Line Disconnect Set

SKU 094653
25187

26⁹⁹

- Used to Remove and Replace Oil and Transmission Cooler Lines On GM, Ford, Nissan and Toyota



4 Piece Disconnect Set

SKU 948999
25183

24⁹⁹

STORE STOCK

- Includes: 1/2", 5/8", 3/4" and 7/8"



Over-Tank Fuel Pump Disconnect Set

SKU 695115
33627131

16⁹⁹

- 5/16" and 3/8"



Heater Hose Disconnect Tool

SKU 695607
33627106

20⁹⁹

- Removes Heater Hoses with 5/8" or 1/4" Quick Disconnect Couplings On '86 to Current Ford Aerostar Vans and '01 to Current Full Size Ford Vans
- Works on Rear Heater Hose Couplings On '86 to Current Chrysler and Plymouth



Ford Clutch Disconnect Tool

SKU 695116
33627130

11⁹⁹

- Works On 1988 to Present Ford Vehicles and Light-Trucks with Hydraulic Clutches



Low Profile Jiffy-Tite Disconnect

SKU 011609
LIS22990

69⁹⁹

- Disengages Jiffy-Tite Quick-Connect Fittings
- No Need to Remove Retaining Clips
- Includes Four Sizes: 3/8", 1/2", 5/8"-30% and 5/8"-39%



Fuel Module Disconnect

SKU 291418
LIS37500

14⁹⁹

- Fits Both 3/8" and 5/16" Connectors and Applications
- Tool Can Be Clipped Together for Convenient Storage



AC/Fuel Line Tool Set

SKU 222520
LIS37000

17⁹⁹

- Set Includes (6) Sizes: 5/16", 3/8", 1/2", 5/8", 3/4" and 7/8"



Angled Disconnect Set

SKU 291416
LIS39400

22⁹⁹

- Disconnects Spring Lock Couplings On Ford and Chrysler A/C Lines
- Works On Fuel Lines and Other Quick Disconnect Couplings On Domestic and Import Vehicles
- (6) Sizes: 5/16", 3/8", 1/2", 5/8", 3/4" and 7/8"



Fuel and AC Disconnect Pliers

SKU 343391
LIS37300

27⁹⁹

- Unique Design Provides Extra Leverage When Disconnecting Quick Connect Coupling Air Conditioning and Fuel Lines



Master Disconnect Tool Set

SKU 291413
LIS39900

59⁹⁹

- Contains (8) Tools for A/C and Fuel Lines
- Comes In a Blow Mold Case



Coolant Hose Removal Tool Set

SKU 383214
CAL244TNZ

29⁹⁹

- Used to Completely Fill the Void In the Connector to Release the Fastener
- 40° Offset Designed for Jobs Up Against the Firewall or In Tight Spaces



Fuel/Transmission Line Disconnect Tool Set

SKU 526503
WLMW89330

19⁹⁹

- Fuel Line Disconnect Tools in Sizes: 5/16, 3/8 and 1/4 Inches
- Oil Cooler Line Disconnect Tool
- Fuel Line Coupling Tool
- Ford and Mercury Oil Cooler Line Disconnect Tool
- Ford and GM Quick Disconnect Tool



While Supplies Last

Master Disconnect Set

SKU 452636
WLMW89331

39⁹⁹

- Performance Master Disconnect Set Includes Disconnect Tools for Air Conditioning, Fuel, Heater, Transmission and Power Steering Lines
- O.E. Tool Identification Number Included
- Tools Color Coded for Easy Identification



While Supplies Last

Master Disconnect Set

SKU 821445
33627318

90⁰⁰

- Easily Disconnects A/C Lines, Fuel Lines and Transmission Cooler Lines
- Includes: Hydraulic Clutch Line Disconnect for GM, 3/8" and 5/16" Fuel Line Retaining Clips for GM, Air Conditioning/Fuel Line Disconnects: 7/8", 3/4", 5/8", 1/2", 3/8" and 5/16"
- Scissor Disconnects: 5/16", 3/8" and 1/2", 3/8"
- Ford: Fuel Line, Oil Cooler Line and Clutch Coupling Remover
- Coupler Disconnects
- Comes in a Sturdy Blow Mold Case



Airsept Smart Splice Multi System Line Repair Tray

SKU 687973
AIR76076

524⁹⁹

- Includes: 1 each 5/16", 3/8", 1/2", 5/8", 3/4" Line Splice Straight SAE Repair Kits; 1 Each 8 mm, 10 mm, 12 mm, 15 mm, 16 mm Line Splice Straight Metric Repair Kits; 1 Each 5/16", 3/8", 1/2", 5/8" Line Splice 45°SAE Repair Kits; 1 Each 5/16", 3/8", 1/2", 5/8" Line Splice 90° SAE Repair Kits
- Top Tray in Master Cabinet



Airsept Smart Splice Ultimate Line Repair Kit

SKU 687976
AIR76057

- Everything Needed to Repair A/C, Power Steering Return, Transmission, Trans Oil Cooler, Engine Oil, Engine Oil Cooler, Coolant and Heater Lines
- OEM Approved Line Repair Solution Installs In Five Minutes, On the Vehicle, Without Special Tools or Adhesives
- Leak Free Up to 2,600 PSI



All-In-One A/C Line Repair Solution!

Windshield Tools

Window Molding Clip Remover

SKU 265130
25338

14⁹⁹

- Use to Release Body Molding Clips
- The Double-Sided Design Works On a Variety of Clip Configurations
- Made with Heat-Treated Carbon Steel for Strength

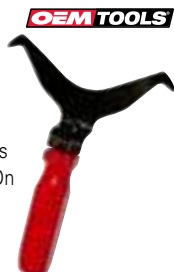

Universal Wiper Arm Puller

SKU 265136
25339

29⁹⁹

- Prevents Damage to Wiper Arm
- Cross-Piece Special for Wiper Featuring a Nozzle



Double Head Suction Cups

SKU 291351
24246

16⁹⁹

- Twin Head Suction Cups Help Remove Windshields
- ABS Rubber Cups Grab Hold to Glass
- Flexible Handle Bends to Windshield



18" Professional Windshield Knife

SKU 480782
CAL53100

24⁹⁹

- Length: 18"
- Constructed of Heavy Duty Steel and Aluminum and a Padded Ergonomic Handle



Windshield Wiper Arm Puller

SKU 191681
25319

15⁹⁹

- Easily Removes Wiper Arms On Most Domestic and Foreign Vehicles



DID YOU KNOW?

AutoZone has availability on Moog HUB Bearings.

Contact Your AutoZone Commercial Sales Manager for Details

PAINT AND BODY

Grinding Points

Glass Bead Coarse Media, 25 Lbs.

SKU 010136 **49⁹⁹**
SHA13077

- Ideal for Many Uses
- Prevents Surface Rust
- Paint and Body Applications
- For Use with OEM 24815 Abrasive Blast Cabinet



NEW

Glass Bead Medium Grit Media, 25 Lbs.

SKU 010139 **49⁹⁹**
SHA13078

- Ideal for Many Uses
- Prevents Surface Rust
- Paint and Body Applications
- For Use with OEM 24815 Abrasive Blast Cabinet



NEW



Grinding Wheels

Depressed Center Hubless Grinding Wheels 4.5" x 1/4" x 7/8" (10 Pack)

SKU 459136 **29⁹⁹**
SHA12661

- Fits 4-1/2" Angle Grinder
- Great for Auto Body Work As Well As All Types of Metal Fabrication and Steel Finishing/Removal
- Max. RPM: 11,900



Depressed Center T27 Hub Grinding Wheels 4.5" x 1/4" x 7/8" - 5/8" - 11NC (10 Pack)

SKU 459155 **39⁹⁹**
SHA12662

- Fits 4-1/2" Angle Grinder with 5/8" - 11NC Arbor
- Great for Auto Body Work As Well As All Types of Metal Fabrication and Steel Finishing/Removal
- Max. RPM: 11,900



14" x 1/8 x 1" Cut-Off Wheel (5 Pack)

SKU 459158 **49⁹⁹**
SHA12663

- Use On Stationary Chop Saws
- Max. RPM: 4,400



Hood Props

Universal Lift Support Adjuster

SKU 191671 **16⁹⁹**
25307

- Holds Weak Gas Charged Lift Supports Open On Hoods, Tailgates, Hatchbacks and Trunks
- Aluminum Body and Brass Threads Prevent Damage to the Lift Support Shaft



Telescopic Hood Support

SKU 420337 **19⁹⁹**
24211

- A Simple Turn Unlocks and Locks Support in Place
- Rubber End Caps Protect Vehicle's Finish
- 21" When Closed and Almost 48" When Fully Extended
- Compact and Easy to Store



Hood Prop with Adapter

SKU 291352 **39⁹⁹**
LIS46170

- Includes a Support to Help Prevent Slipping
- 3 Piece Telescoping Shaft Locks in Any Position - (Telescopes from 20" to 4-1/4')

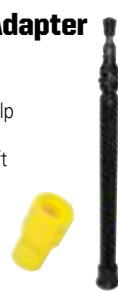

Hatch Jammer Lift Gate and Hatch Holder

SKU 222853 **59⁹⁹**
STK17200

- Holds Hatch Open and Secure for Prep, Paint, Buffing and Paintless Dent Removal
- Extends to 59"



Door Tools

Door Panel Remover

SKU 048579 **9⁹⁹**
25313

- For Easy Removal of Door Panel Clips without Damage



Window and Door Clip Remover/Installer

SKU 191679 **9⁹⁹**
25311

- Works On GM, Ford and Other Vehicles Using the Common "C" Type Clip



Door Hinge Adjuster

SKU 447144 **49⁹⁹**
25946

- Adjusts Door Hinge Position On Most Vehicles
- Two Head Adapter Works with Large and Small Latches

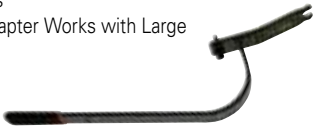

Door Spring Tool

SKU 447118 **16⁹⁹**
25336

- Quickly and Easily Remove or Install Door Hinge Springs
- Designed for GM Cars and Light-Trucks



5 Piece Door Panel and Trim Tool Set

SKU 989263 **39⁹⁹**
25312

- Comprised of 3 Door Panels and 2 Trim Tools
- Textured, Comfortable Grips with Thumb Stop and Hanging Hole



Black Axle Zipper2

SKU 010125 **39⁹⁹**
STK21894

- Air Hammer Driven Door Skinning Tool for the Window Flange
- Self-Lubricating Reinforced Nylon Head
- Crimps Door Skin to the Door Shell at Window Opening



Replacement Head

SKU 010118 **24⁹⁹**
STK21895



NEW

Red Al Skin Zipper

SKU 010133 **44⁹⁹**
STK21892

- For Any 1 mm Aluminum Skin and 1.5 mm Door Shell
- Skins Doors in Approximately 15 Minutes
- Self Lubricating Reinforced Nylon Head



Replacement Head

SKU 010130 **29⁹⁹**
STK21893



NEW

Red Al Skin Zipper2

SKU 010121 **44⁹⁹**
STK21896

- Air Hammer Driven Skinning Tool Aluminum Doors
- Self-Lubricating Reinforced Nylon Head
- 2 Step Process



Replacement Head

SKU 010123 **29⁹⁹**
STK21897



NEW

Dent Pullers

Pull Rod Set

SKU 964653 **44⁹⁹**
STK20000

- Super Tough Alloy Steel is Precisely Heat-Treated for Maximum Strength
- Kit contains: 4) Pull Rods and (2) Pick Rods, Stainless Steel Straight Edge, HS Split Point Drill Bit, Instruction Sheet



Body Tools

7 Piece Body Tool Set

SKU 900813 **49⁹⁹**
25924

- Standard Bumping Hammer
- Pick and Finish Hammer
- Reversed Curve Hammer
- Shrinking Dolly
- Two Ended and Curved Dolly



Hog Ring Plier Set

SKU 447162 **44⁹⁹**
25931

- Use On the Upholstery Work of Most Domestic and Foreign Cars
- Includes 45° and Straight Hog Ring Pliers



Trim Clip Plier Set

SKU 447152 **39⁹⁹**
25947

- Quickly Removes Plastic Anchors that Have Center Pins without Damage to Pins or Anchors



Panel Clip Pliers

SKU 447154 **24⁹⁹**
25930

- Minimizes Risk of Damage to the Clip and Panel During Removal



Body Clip Pliers

SKU 094657 **22⁹⁹**
25923

- Designed to Remove Any Clip Found On Trim, Bumpers, Etc.
- Steel Levers Enclosed in Plastic, Prevents Scratches

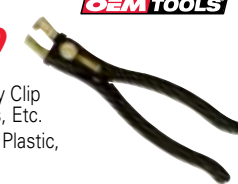

5 Piece Fastener and Molding Remover Set

SKU 900801 **17⁹⁹**
25314

- Includes (5) Tools for Easy Removal of Fasteners, Molding, Wheel Hubs and More
- For Use On Internal and External Vehicle Molding and Trim Fasteners

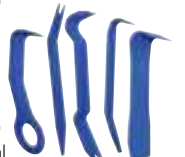

Easy Pry Tool

SKU 222857 **19⁹⁹**
STK21730

- Non-Marring Wedge
- 1" Blade with a Curved Clip End that Allows Easy Access and Removal of Plastic Bezels, Moldings, Trim and Panels without Scratching the Surface



Air Bag Release Tool for GM

SKU 191678 **16⁹⁹**
25310

- Fits Most GM Cars, Minivans and Light-Trucks
- Tips Are Tapered to Make Removal Easier



Super Dent Puller Set

SKU 265148 **169⁹⁹**
25922

- 12 Lbs. Hammer, Slide Hammer Shaft, Slide Hammer Handle, Slide Hammer Adapter, Deep Hook, Short Hook, Door Edge Tool, Claw, Straight Driver, Hook and Chain, Sheet Metal Screw and Holder, Nose Piece with Screw
- Comes in a Blow Mold Case



Limited Availability

394 Piece Technician's Starter Set

Duralast

394 Piece Technician's Starter Set
SKU 388834
70-513

2,299⁹⁹

REG PRICE: \$2,499.99

SAVE \$200⁰⁰*

Includes:

- 394 Piece Technician's Kit
SKU 125700
70-515
- 36" Combo Tool Cart and Cabinet
SKU 850534
24573

OEM TOOLS



394 Piece Technician's Kit Includes:

- (1) Tool Box
- (14) 1/2" Drive Shallow SAE Sockets in Sizes: 1/2" to 1-1/2"
- (12) 1/2" Drive Deep SAE Sockets in Sizes: 1/2" to 1-1/2"
- (15) 1/2" Drive Shallow Metric Sockets in Sizes: 10 to 24 mm
- (15) 1/2" Drive Deep Metric Sockets in Sizes: 10 to 24 mm
- (9) 1/4" Drive Shallow SAE Sockets in Sizes: 3/16" to 1/2"
- (9) 1/4" Drive Deep SAE Sockets in Sizes: 3/16" to 1/2"
- (12) 1/4" Drive Shallow Metric Sockets in Sizes: 4 to 15 mm
- (12) 1/4" Drive Deep Metric Sockets in Sizes: 5 to 15 mm
- (11) 3/8" Drive Shallow SAE Sockets in Sizes: 3/8 to 5/16"
- (15) 3/8" Drive Shallow Metric Sockets in Sizes: 7 to 21 mm
- (11) 3/8" Drive Deep SAE Sockets in Sizes: 3/8" to 5/16"
- (14) 3/8" Drive Deep Metric Sockets in Sizes: 8 to 21 mm
- (2) 3/8" Spark Plug Sockets
- (2) 3/8" Magnetic Spark Plug Sockets
- (1) 12 Piece Star Bit Set
- (2) 3/8" Drive Hex Bit Sockets
- (10) Extension Bars
- (1) 9 Piece Tamper Proof Star Bit Set
- (1) 4 Piece Adapter Set
- (1) 3 Piece U-Joint Set
- (1) 5 Piece Impact Driver with 4 Bits
- (31) Combo Wrenches in Sizes: 1/4" to 1" SAE and 7 to 24 mm
- (4) Adjustable Wrenches in Sizes: 6" to 12"
- (14) Ratcheting Wrenches in Metric and SAE Sizes
- (2) 3 Piece Flare Nut Wrench Sets in Metric and SAE Sizes
- (14) Nut Drivers in SAE and Metric Sizes
- (1) Spinner Handle
- (8) Slotted and Phillips Screwdrivers
- (2) Star Key Driver Sets: 8 Piece Folding, 9 Piece Standard
- (2) Metric Hex Key Sets: 8 Piece Folding, 8 Piece Standard
- (2) SAE Hex Key Sets: 8 Piece Folding, 9 Piece Standard
- (8) Pliers: Slip Joint, Long Nose, Diagonal and Groove Joint
- (5) Locking Pliers
- (1) Heavy Duty Snap Ring Plier Set
- (4) Ratchets
- (2) Hammers: One Dead Blow and One Ball Peen
- (1) Heavy Duty Circuit Tester
- (1) Wire Stripper
- (1) 3/4" x 12" ExtraMark® Power Tape
- (1) Magnetic Pick-Up Tool
- (2) Inspection Mirrors and Pick-Up Tools
- (2) LED Flashlights
- (5) Scrapers
- (1) 4 Piece Pry Bar Set
- (1) 16 Piece Punch and Chisel Set
- (1) Hacksaw
- (2) Hook and Pick Sets: 5 Piece Standard and 4 Piece Jumbo
- (1) Breaker Bar
- (1) 3 Piece Wire Brush Set
- (1) 3 Piece File Set
- (1) Putty Knife
- (1) Fender Cover

Offer Good Through September 30, 2016 While Supplies Last

SPECIAL

Tool Set Savings: \$200.00
Bonus Tool Cart: \$799.99
***TOTAL SAVINGS: \$999.99**

For More Information Contact AutoZone Tool and Equipment Customer Service at 1-877-AZTool1 (1-877-298-6651)

This all purpose technician's starter set features the 36" OEMTOOLS® toolbox stocked with a well-balanced selection of basic hand and specialty tools.

OEMTOOLS® toolboxes combine the flexibility of a drawer toolbox with the efficiency and organization of the patented peg tool storage system. You'll work faster and more efficiently with the most-used tools placed at your fingertips. This toolbox set comes with over 390 of the most commonly used tools and features Duralast® tools.

Tool Sets

Duralast

13 Piece Ratchet and Socket Set Metric (3/8" Drive)

SKU 454333 39⁹⁹
70-518

STORE STOCK

- Includes: 3/8" Drive Ratchet, 3" Extension, 5/8" Spark Plug Socket
- 6 Point Metric Sockets: 8, 9, 10, 11, 12, 13, 14, 15, 17 and 19 mm
- Set Comes in an Organizational Case



13 Piece Ratchet and Socket Set SAE (3/8" Drive)

SKU 454335 39⁹⁹
70-517

STORE STOCK

- Includes: 3/8" Drive Ratchet, 3" Extension, 5/8" Spark Plug Socket
- 6 Point SAE Sockets: 1/4", 5/16", 3/8", 7/16", 1/2", 9/16", 5/8", 11/16", 3/4" and 13/16"
- Set Comes in an Organizational Case



24 Piece Ratchet and Socket Set - Metric and SAE

SKU 454336 54⁹⁹
70-519

STORE STOCK

- Color Coded for Easy Identification
- Includes: 3/8" Drive Ratchet, 3" Extension, 5/8" Spark Plug Socket
- 6 Point Metric Sockets: 8, 9, 10, 11, 12, 13, 14, 15, 17 and 19mm
- 6 Point SAE Sockets: 1/4", 5/16", 3/8", 7/16", 1/2", 9/16", 5/8", 11/16", 3/4" and 13/16"
- Fully Polished with Knurled Handles for Non-Slip Gripping
- Sturdy Storage Case Keeps Set Organized



Spark Plug Sockets

MAGNETIC

5/8" x 6" Magnetic Spark Plug Extension

SKU 454330 12⁹⁹
75-499

- Chrome Vanadium for Strength
- Fully Polished to Resist Rust
- 3/8" Drive
- Color Coded Blue - SAE

Magnetic Spark Plug Sockets 13/16"

SKU 482598 6⁹⁹
75-506

- 3/8" Drive
- Knurled for Easy Hand Turning
- Magnetic Plug Retainer for Better Hold

9/16" x 6" Magnetic Spark Plug Extension

SKU 454328 14⁹⁹
75-498

- Chrome Vanadium for Strength
- Fully Polished to Resist Rust
- 3/8" Drive
- Color Coded Blue - SAE

5/8" Magnetic Spark Plug Sockets

SKU 482599 6⁹⁹
75-508

- 3/8" Drive
- Knurled for Easy Hand Turning
- Magnetic Plug Retainer for Better Hold

Star Bit Set

12 Piece Star Bit Set

SKU 914172 29⁹⁹
70-055

STORE STOCK

- 1/4" Drive: T10, T15, T20, T25, T27 and T30
- 3/8" Drive: T40, T45, T47, T50 and T55
- 1/2" Drive: T60



Adapters

- 1/4" M x 3/8" F Adapter SKU 482536 73-814 4⁹⁹
- 3/8" M x 1/4" F Adapter SKU 557436 73-816 4⁹⁹
- 3/8" M x 1/2" F Adapter SKU 482534 73-812 6⁹⁹
- 1/2" M x 3/8" F Adapter SKU 482535 73-813 4⁹⁹
- 3/4" M x 1/2" F Adapter SKU 560449 73-413 5⁹⁹

All Open Stock Items Available in Store



Extensions

All Open Stock Items Available in Store

- 1/4" Drive Extension Bar 2" SKU 482524 71-401 3⁹⁹
- 1/4" Drive Extension Bar 6" SKU 482525 71-403 4⁹⁹
- 3/8" Drive Extension Bar 1-3/4" SKU 482530 73-801 4⁹⁹
- 3/8" Drive Extension Bar 3" SKU 482531 73-803 5⁹⁹
- 3/8" Drive Extension Bar 6" SKU 482532 73-806 6⁹⁹
- 3/8" Drive Locking Extension Bar 6" SKU 604193 73-807 9⁹⁹
- 3/8" Drive Extension Bar 10" SKU 482533 73-810 7⁹⁹
- 3/8" Drive Extension Bar 18" SKU 557432 73-818 10⁹⁹
- 1/2" Drive Extension Bar 3" SKU 947314 72-105 5⁹⁹
- 1/2" Drive Extension Bar 6" SKU 482528 72-106 7⁹⁹
- 1/2" Drive Extension Bar 10" SKU 557429 72-110 8⁹⁹

3 Piece Locking Extension Set

SKU 595333 14⁹⁹
70-123

- Push Button Quick Release
- 1/4" Drive x 6", 3/8" Drive x 10" and 1/2" Drive x 5"



DID YOU KNOW?

AutoZone offers Filter Stocking Programs to include oil, air, fuel, cabin air and transmission filters.

Contact Your AutoZone Commercial Sales Manager for Details

20 Piece Screwdriver Set

SKU 363800
70-204

24⁹⁹
REG: \$34.99

- Set Includes:**
- Slotted: 3/32" x 2", 1/8" x 2-1/2", 3/16" x 4", 1/4" x 4", 1/4" x 6", 1/4" x 1-1/2", Offset Screwdriver
 - Phillips: #00 x 1-1/2", #0 x 2-1/2", #1 x 3", #2 x 4", #2 x 6", #2 x 1-1/2"; Star: #15, #20, #2 Square Plus 4 Piece Hook and Pick Set
 - Acetate Handles



SAVE \$10

BONUS

Screwdriver Magnetizer

SKU 452634 | Part# 24214

VALUE: \$3.99

with Purchase of:

20 Piece Screwdriver Set

SKU 363800 | Part# 70-204

Offer Good Through September 30, 2016
While Supplies Last

Ratchets

Standard Duralast Ratchets

Durable Chrome Plating for Strength
Ratchet Has 10° Swing Arc and 36 Teeth
STORE STOCK

1/4" Drive Ratchet SKU 482526 16⁹⁹

3/8" Drive Ratchet SKU 482537 15⁹⁹

1/2" Drive Ratchet SKU 482529 24⁹⁹

Flexhead Ratchets

Flexhead Design Swings 180° to Reach Around Obstructions
Ratchet Has 10° Swing Arc with 36 Teeth
Designed with Durable Chrome Plating and a Comfortable Ergonomic Grip
STORE STOCK



Flexible Head for Tight Spaces

3/8" Drive Flexhead Ratchet

SKU 482538 73-871 22⁹⁹

1/4" Drive Flexhead Ratchet

SKU 482527 71-417 19⁹⁹

Round Head Ratchets

CR-V Steel
Knurled Grip

3/4" Drive Round Head Ratchet

SKU 914050 72-130 36⁹⁹

STORE STOCK

3/8" Drive Stubby Ratchet

SKU 482540 22⁹⁹



3/8" Drive Comfort Handle Ratchet

SKU 482541 24⁹⁹

While Supplies Last

1/2" Drive Comfort Handle Ratchet

SKU 557430 24⁹⁹



3/8" Drive Super 72 Ratchet

SKU 454285 26⁹⁹ **STORE STOCK**

- Sealed Head Keeps Dust and Dirt Out
- 72 Teeth, Fine Tooth Design Offers 5° Backlash
- Quick Release for Secure Holding of Sockets
- One Finger Reverse Switch



1/2" Drive Super 72 Ratchet

SKU 454286 29⁹⁹ **STORE STOCK**

- Sealed Head Keeps Dust and Dirt Out
- 72 Teeth, Fine Tooth Design Offers 5° Backlash
- Quick Release for Secure Holding of Sockets
- One Finger Reverse Switch

1/2" Drive Breaker Bar 24" SKU 560039 19⁹⁹ • Flexhead Drive • Socket Retainer

While Supplies Last

Flare Nut Wrenches

Flare Nut Wrench Set (SAE)

SKU 914117 15⁹⁹

- STORE STOCK**
- SAE: 3/8" x 7/16", 1/2" x 9/16" and 5/8" x 11/16"



Flare Nut Wrench Set (Metric)

SKU 914115 17⁹⁹

- STORE STOCK**
- Metric: 10 x 12 mm, 13 x 14 mm and 15 x 17 mm

Ratcheting Wrench Sets

7 Piece Slip Resistant Ratcheting Wrench Set

SKU 607062 (Metric) 51⁹⁹

- STORE STOCK**
- Metric: 8, 10, 12, 13, 14, 15 and 18 mm

Ratcheting Wrenches Are Precision Engineered with 5° Swing Arc Action to Get Into the Tightest Spots.



SKU 607063 (SAE) 49⁹⁹

- STORE STOCK**
- SAE: 5/16", 3/8", 7/16", 1/2", 9/16", 5/8" and 3/4"

4 Piece Double Offset Ratcheting Wrench Set

SKU 561039 SAE 59⁹⁹

- STORE STOCK**
- SAE: 5/16" x 3/8", 7/16" x 1/2", 9/16" x 5/8" and 11/16" x 3/4"



2 Piece Double Duty Wrench Set

SKU 951644 (Metric) 29⁹⁹

- STORE STOCK**
- Metric: 8, 10, 12, 13, 14, 17, 18 and 19 mm
 - SAE: 5/16", 3/8", 7/16", 1/2", 9/16", 5/8", 11/16" and 3/4"



8 Wrenches for the Price of 2

SKU 951643 (SAE) 70-009

29⁹⁹ **STORE STOCK**

Duralast

9 Piece 3/8" Drive Low Profile Socket Set - Metric

SKU 754705 19⁹⁹

- Includes: 8, 10, 12, 13, 14, 15, 16, 17, 18 mm Sockets

LOWER



30%

Standard Socket



Works great in tight spaces



Duralast

9 Piece 3/8" Drive Low Profile Socket Set - SAE

SKU 754704 19⁹⁹

- Includes: 1/4", 5/16", 7/16", 3/8", 1/2", 9/16", 5/8", 11/16", 3/4" Sockets



Pliers



6" Slip Joint Pliers

SKU 482480 6⁹⁹

8" Slip Joint Pliers

SKU 482481 6⁹⁹

6.5" Diagonal.....SKU 482485 77-206 7⁹⁹

7.5" Diagonal.....SKU 482486 77-207 9⁹⁹

8" LinesmanSKU 482487 77-308 17⁹⁹

6.5" Long Nose SKU 482483 77-106 7⁹⁹

8" Long NoseSKU 482484 77-108 8⁹⁹

All Open Stock Items Available in Store

Groove Joint Pliers **STORE STOCK**

6" Groove Joint SKU 482488 77-406 8⁹⁹

8" Groove Joint SKU 482490 77-408 11⁹⁹

10" Groove Joint SKU 482491 77-410 13⁹⁹

12" Groove Joint SKU 482492 77-412 14⁹⁹

16" Groove Joint SKU 914072 77-416 27⁹⁹

Long Nose and Curve Jaw Locking Pliers **STORE STOCK**

4" Curve JawSKU 600989 77-504 9⁹⁹

5" Curve JawSKU 482494 77-505 9⁹⁹

6.5" Long NoseSKU 482495 77-506 11⁹⁹

7" Curve JawSKU 482496 77-507 12⁹⁹

9" Long NoseSKU 600990 77-509 14⁹⁹

10" Curve JawSKU 482498 77-510 14⁹⁹

19" Chain LockingSKU 600991 77-519 21⁹⁹

Socket Sets

5 Piece Mortorq® Super Socket Set

SKU 750019 49⁹⁹

- Sizes: M0, M1, M2, M3, M4, Services New Fasteners Found On GM, Chrysler, BMW, Nissan, etc.



STORE STOCK

Wrenches

Wrenches Are Forged with Longer Shanks for Extra Leverage.



Metric

7 mm Combo Wrench.....SKU 482606.....79-007 6⁹⁹

8 mm Combo WrenchSKU 48260779-008 6⁹⁹

9 mm Combo WrenchSKU 48260879-009 7⁹⁹

10 mm Combo WrenchSKU 48260979-010 7⁹⁹

11 mm Combo Wrench.....SKU 48261079-011 7⁹⁹

12 mm Combo Wrench.....SKU 48261179-012 7⁹⁹

13 mm Combo Wrench.....SKU 48261379-013 7⁹⁹

14 mm Combo Wrench.....SKU 48261479-014 8⁹⁹

15 mm Combo Wrench.....SKU 48261579-015 8⁹⁹

16 mm Combo Wrench.....SKU 48261679-016 8⁹⁹

17 mm Combo Wrench.....SKU 48261779-017 8⁹⁹

18 mm Combo Wrench.....SKU 48261879-018 9⁹⁹

19 mm Combo Wrench.....SKU 48261979-019 9⁹⁹

20 mm Combo Wrench.....SKU 48262179-020 10⁹⁹

21 mm Combo Wrench.....SKU 48262279-021 10⁹⁹

22 mm Combo Wrench.....SKU 48262379-022 10⁹⁹

23 mm Combo Wrench.....SKU 48262479-023 12⁹⁹

24 mm Combo Wrench.....SKU 48262579-024 12⁹⁹

SAE

1/4" Combo Wrench.....SKU 48262679-100 6⁹⁹

5/16" Combo Wrench.....SKU 48262779-101 6⁹⁹

3/8" Combo Wrench.....SKU 48262879-102 6⁹⁹

7/16" Combo Wrench.....SKU 48262979-103 6⁹⁹

1/2" Combo Wrench.....SKU 48263079-104 6⁹⁹

9/16" Combo Wrench.....SKU 48263179-105 6⁹⁹

5/8" Combo Wrench.....SKU 48263279-106 6⁹⁹

11/16" Combo Wrench.....SKU 48263379-107 8⁹⁹

3/4" Combo Wrench.....SKU 48263479-108 8⁹⁹

13/16" Combo Wrench.....SKU 48263579-109 9⁹⁹

7/8" Combo Wrench.....SKU 48263679-110 9⁹⁹

15/16" Combo Wrench.....SKU 48263779-111 11⁹⁹

1" Combo WrenchSKU 48263979-112 13⁹⁹

1-1/16" Combo Wrench.....SKU 48264079-113 14⁹⁹

1-1/8" Combo Wrench.....SKU 48264179-114 15⁹⁹

1-1/4" Combo Wrench.....SKU 48264279-115 16⁹⁹

All Open Stock Items Available in Store

Wide Mouth Adjustable Wrenches

Store Stock

- Chrome Plated Finish Resists Rust
- Jaws Open Extra Wide for Added Versatility
- Ruler for Quick, Accurate Adjustment



6" Adjustable.....SKU 482601 78-006 8⁹⁹

8" Adjustable.....SKU 482602 78-008 9⁹⁹

10" Adjustable.....SKU 482603 78-010 11⁹⁹

12" Adjustable.....SKU 482605 78-012 15⁹⁹

HAND TOOLS

BONUS
VALUE: \$39.99

5/8" x 36" Pry Bar
SKU 695126 | Part# 24435



with Purchase of:
3 Piece Pry Bar Set
SKU 626114 | Part# 24433

3 Piece Pry Bar Set

SKU 626114
24433

OEM TOOLS



- Pry Bar Sizes: 3/8" x 12", 7/16" x 18" and 7/16" x 24"
- Unique Ergonomically Designed 3 Sided Handle for Secure Grip and Comfort
- Handles Are Solvent Resistant and Easy to Clean
- Comes in a Plastic Tray

Offers Good Thru September 30, 2016 - While Supplies Last

Pick-Up Tools

3-in-1 Pick-Up Tool Magnet, Claw and LED

SKU 110277
25293

19⁹⁹

- 24-1/2" Flexible Reach
- 4 Claw Grip for Easy Pick-Up
- Magnetic End with Extra Strong Hold
- Bright LED Lighted Base for Convenience
- 72 Teeth Driving System
- Flexible Rotating Ratchet Head
- Quick Release Button



OEM TOOLS



HD Pick-up Tool

SKU 231205
25466

7⁹⁹

- Features a Rotary Hand Pump and a 6' Discharge Hose with a Steel J-Hook

STORE STOCK

Magnetic Finger Tool

SKU 462985
BKG129

16⁹⁹

Slips On Your Finger and Turns It into a Professional Tool



Pry Bars

5/8" x 36" Pry Bar

SKU 695126
24435

39⁹⁹



OEM TOOLS

- Unique Ergonomically Designed 3 Sided Handle for Secure Grip and Comfort
- Handles Are Solvent Resistant and Easy to Clean
- Dimensions: 5/8" x 36"

Drive Bits

OEM TOOLS

9 Piece Twist Handle Hex Key Set-Metric

SKU OUTSIDE BUY/EPO
24263

12⁹⁹

- Includes Metric Sizes: 1.5, 2, 2.5, 3, 4, 5, 6, 8 and 10 mm
- Color Coded Blue - Metric
- Twisted Handle Adds 150% More Torque Strength



Available via Outside Buy/EPO, Call (1-877-238-6651) for details.

9 Piece Twist Handle Hex Key Set-SAE

SKU OUTSIDE BUY/EPO
24264

12⁹⁹

- Includes SAE Sizes: 1/16", 5/64", 3/32", 1/8", 5/32", 3/16", 1/4", 5/16" and 3/8"
- Color Coded Red - SAE
- Twisted Handle Adds 150% More Torque Strength



Available via Outside Buy/EPO, Call (1-877-238-6651) for details.

9 Piece Long Star Key Set

SKU OUTSIDE BUY/EPO
24262

14⁹⁹

- Includes Sizes: T10, T15, T20, T25, T27, T30, T40, T45 and T50
- Color Coded Green - Star
- Magnetic Tips Hold Fasteners in Place and Prevents Them from Slipping
- Twisted Handle Adds 150% More Torque Strength



Available via Outside Buy/EPO, Call (1-877-238-6651) for details.

9 Piece Magnetic Long Arm Hex Key Set (SAE)

SKU OUTSIDE BUY/EPO
24261

14⁹⁹

- Includes SAE Sizes: 1/16", 5/64", 3/32", 1/8", 5/32", 3/16", 1/4", 5/16" and 3/8"
- Color Coded Red - SAE
- Magnetic Tips Hold Fasteners in Place and Prevents Them from Slipping



Available via Outside Buy/EPO, Call (1-877-238-6651) for details.

35 Piece Master Torx Bit Set

SKU 466622
25951

49⁹⁹

OEM TOOLS

S2

- Star: T8, T10, T15, T20, T25, T27, T30, T40, T45, T47, T50, T55 and T60
- Tamper-Proof Star: T7, T8, T9, T15, T20, T25, T30, T40, T45, T50 and T55
- Female Star: E4, E5, E6, E7, E8, E10, E12, E14, E16 and E18



44 Piece Master Torx and Hex Bit Set

SKU 311698
25950

46⁹⁹

OEM TOOLS

S2

- Hex: 2, 2.5, 3, 4, 5, 6, 7, 8, 10; 1/8", 5/32", 3/16", 7/32", 1/4", 5/16" and 3/8"
- Star: T10, T15, T20, T25, T27, T30, T40, T45, T47, T50, T55 and T60
- Phillips: #1, #2 and #3
- Slotted: 3/16", 1/4" and 5/16"
- Bits: T7H, T8H, T9H, T10H, T15H, T20H, T25H, T27H and T30H



Master Hex Bit Set

SKU 094663
25952

49⁹⁹

OEM TOOLS

S2

- 1/4" Drive: 1/8", 5/32", 3/16" and 7/32"
- 3/8" Drive: 1/4", 9/32", 5/16" and 11/32"
- 1/2" Drive: 3/8", 1/2", 9/16", 3/4" and 5/8"
- 1/4" Drive: 2.5, 3, 4 and 5 mm
- 3/8" Drive: 6, 7, 8 and 9 mm
- 1/2" Drive: 10, 12, 14, 17 and 19 mm
- Comes in a Blow Mold Case



13 Piece 1/4" Drive

SKU 447157
24293

29⁹⁹

- Sizes: T7-T50

OEM TOOLS



11 Piece Tamper-Proof Torx Plus Bit Socket Set

SKU 255725
22973

59⁹⁹

- Set Includes: (1/4" Drive) 8-TPT, 10-TPT, 15-TPT, 20-TPT and 25-TPT
- (3/8" Drive) 27-TPT, 30-TPT, 40-TPT, 45-TPT, 50-TPT and 55-TPT



Tamper-Resistant Star Security Bits

OEM TOOLS



Stubby Star Drive Sets

- 3/4" Overall Length Designed for Limited Access Applications
- S2 Steel for Strength and Durability

Tamper-Proof 13 Piece 1/4" Drive

SKU 447156
24294

34⁹⁹

- Sizes: T7-T50



10 Piece External Torx Socket Set

SKU 347214
22974

39⁹⁹

- Set Includes: 1/4" Drive: E4, E5, E6, E7
- 3/8" Drive: E8, E10, E11, E12, E14 and E16



OEM TOOLS



7 Piece Hex Bit Set - Metric

SKU 127883
22981

48⁹⁹

- Set Includes: (3/8" Dr.) 6, 8, 10 mm, (1/2" Dr.) 12, 14, 17, 19 mm
- Made with S2 Steel Bits
- Knurling Position Is Optimized for Best Finger Gripping Position. Go Ahead and Put Serious Torque On, It Won't Slip
- Silver with Cross Hatch Marking Indicates Metric Sizes
- Chamfered Ends Allow the Socket to Easily Slip Over the Bolt Head. Makes Fastener Engagement Quick and Smooth



7 Piece Hex Bit Set - SAE

SKU 127904
22982

59⁹⁹

- Set Includes: (3/8" Dr.) 5/16", 3/8", (1/2" Dr.) 7/16", 1/2", 9/16", 5/8", 3/4"
- Made with S2 Steel Bits
- Knurling Position Is Optimized for Best Finger Gripping Position. Go Ahead and Put Serious Torque On, It Won't Slip
- Blue with Straight Knurling Indicates SAE Sizes
- Chamfered Ends Allow the Socket to Easily Slip Over the Bolt Head. Makes Fastener Engagement Quick and Smooth



9 Piece Triple Square Bit Set

SKU 191052
25953

31⁹⁹

- Set Includes: 1/4" Drive: M4, M5 and M6 S2 Steel Bits with Chrome Vanadium Socket
- 3/8" Drive: M8, M10 and M12 S2 Steel Bits with Chrome Vanadium Socket
- 1/2" Drive/Tamper-Proof: M14, M16 and M18
- S2 Steel Bits with Chrome Vanadium Socket



Compact Bit Driver Set

SKU 447158
25945

16⁹⁹

- Includes: Phillips, 1, 2, 3; Slotted 3/16, 1/4, 5/16; T15, T20, T25 and T30 with Magnetic Extension
- Ergonomic Case Converts to Driver and Stores All Components



Pliers

GreatNeck

3 Piece, 11" Hose Gripper Plier Set

SKU 094811
L311L

19⁹⁹

- Extra Long Handle Gets into Tight Areas
- Includes Sizes: 5/16", 1/2" and 3/4"
- Ideal for Removing Cooling System, Fuel and Vacuum Lines
- Heat-Treated, Ergonomic Comfort Grip Handles



Soft Jaw Pipe and Connector Gripping Pliers

SKU 042414
KNP8111250

74⁹⁹

NEW

- For Siphon Tube Fittings and Connectors Up to 80mm Diameter
- 25 Adjustment Positions
- Chrome Vanadium Electric Steel
- Exchangeable Plastic Jaws for Sensitive Surfaces

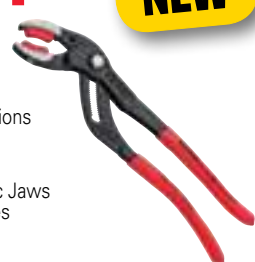

3 Piece Universal Set with Cobra

SKU 505070
KNP002008US2

89⁹⁹

- Perfect Variety Set for Your Most Demanding Jobs
- Set Includes:
 - 8" Long Nose Pliers
 - 8" High Leverage Diagonal Pliers
 - 10" Cobra Water Pump Pliers



3 Piece Cobra Pliers Set

SKU 505075
KNP002006US1

119⁹⁹

- Comfort Grip, Two-Color Dual Component Handles
- Box-Joint Design is Highly Stable Because of a Double Guide
- Fast Adjustment Directly on the Work Piece
- Pinch Guard Prevents Operators' Fingers from Being Pinched
- Contains Special Hardened Teeth
- Grips Any Shaped Object - Round, Square, Hex or Flat





Contact Us:
1-877-AZTool1 Phone
 (1-877-298-6651) *Hablamos Español*

Ratchets and Socket Sets



360° Swivel Ratchets
3/8" Drive
 SKU 095065 28098
24⁹⁹
(While Supplies Last)

1/2" Drive
 SKU 095066 38098
29⁹⁹

- 72 Teeth Driving System
- Flexible Rotating Ratchet Head
- Quick Release Button



Swivels

21 Piece 3/4" Drive Ratchet and Socket Set
 SKU 237647 SSH21
199⁹⁹

- Set Includes: 3/4" Drive Ratchet, Breaker Bar, 4" and 8" Extensions
- Standard SAE Sockets: 7/8", 15/16", 1-1/16", 1-1/8", 1-3/16", 1", 1-1/4", 1-5/16", 1-3/8", 1-7/16", 1-1/2", 1-5/8", 1-3/4", 1-13/16", 1-7/8" and 2"



3 Piece Low Profile Adapter Set

SKU 818570 22535
19⁹⁹

- CR-V Steel for Strength
- Chrome Finish to Resist Rust
- Get into Tighter Spaces
- Includes Sizes: 1/4 F x 3/8 M, 3/8 F x 1/2 M and 1/2 F x 3/4 M



Mechanic's Tool Set



121 Piece Mechanic's Tool Set
 SKU 850892 23984
299⁹⁹

- Set Comes in Blow Mold Case To Keep Tools Organized
- Includes: Combo Wrenches, 1/4" and 3/8" Drive Sockets, Extension Bars, and Ratchets, Long Nose, Diagonal, and Groove Joint Pliers, Reducing Adapters, Ratcheting Screwdriver with 6" Bit Driver Blade, 33 Piece Chrome Plated Bit Set, SAE and Metric Hex Key Sets and More



Ratcheting Screwdriver With 45 Tooth Ratcheting Mechanism and 3 Locking Positions for Smooth Strokes

Features:

- POSI-GRIP NO-SLIP® Socket Off Corner Loading for Greater Torque with More Socket-to-fastener Contact
- SEALED RATCHETS to Keep Out Dirt and Debris
- HARD CHROME FINISH Smooth Satin Finish Is Easy to Clean, Won't Show Prints and Keeps Rust Away
- PRECISION MACHINED JAWS Precise Gripping and Maximum Strength

Adapters



4 Piece Swivel Adapter Set
 SKU 191043 24270
39⁹⁹

- Includes Sizes: 1/4" M x 3/8" F, 3/8" M x 1/4" F, 1/2" M x 3/8" F, 3/8" M x 1/2" F
- Pinless Design Enhances Strength and Life



Swivel Provides Constant Torque



DID YOU KNOW?

AutoZone carries vehicle make specific body fastener kits.

Contact Your AutoZone Commercial Sales Manager for Details

Extensions



10" Quick Extension

1/4" Drive
 SKU 965842 18096
14⁹⁹

3/8" Drive
 SKU 965843 28096
15⁹⁹



Extra Long 3 Piece 3/8" Drive Extension Set

SKU 094813 68034
29⁹⁹

- Includes: 18", 24" and 30" Extensions



SAVE \$20

Flare Nut Ratcheting Wrench Sets



SAE
 SKU 432074 22060
79⁹⁹ REG. \$99.99
 • 3/8" x 7/16", 1/2" x 9/16", 5/8" x 11/16"

Metric
 SKU 432076 22061
79⁹⁹ REG. \$99.99
 • 10 x 12 mm, 13 x 14 mm, 15 x 17 mm



RATCHETING SYSTEM AND FLEXHEAD
 Tilts Up to 180 Degrees at Any Interval to Allow for Access into Tight Spaces

Offer Good Through September 30, 2016 - While Supplies Last

Screwdriver Sets



22 Piece Stubby Ratcheting Screwdriver Set

SKU 094659 25942
29⁹⁹

- 45 Tooth Ratcheting Mechanism for Smooth Ratcheting Stroke
- 3 Locking Positions
- Includes: Slotted: 4", 5", 5-1/2", 6-1/2"; Phillips: #1, #2, #3; Star: T10, T15, T20, T25, T27, T30, T40; Poz: POZ1, POZ2,



37 Piece Ratcheting Screwdriver Set

SKU 094661 25943
49⁹⁹

- 45 Tooth Ratcheting Mechanism for Smooth Ratcheting Stroke, 3 Locking Positions
- Includes: Phillips: #1, #2, #3; Hex: 5/32", 3/16", 7/32", 5/16"; Slotted: 5/32", 3/16", 7/32", 1/4"; Star: T10, T20, T25, T27, T30, T40; Sockets: SAE: 7/32", 1/4", 9/32", 5/16", 11/32", 3/8", 7/16", 15/32"; Metric: 5, 6, 7, 8, 10, 12, 14 mm; 1/4" Socket Adapter, 6" Magnetic Bit Shaft, 11" Flexible Bit Shaft and 10" Socket Shaft Extension
- Comes in a Blow Mold Case



Insulated Automotive Electrical Screwdriver Set

SKU 010812 KNP9K989820US
129⁹⁹

- Insulated to 1000V
- 10" High Leverage Diagonal Cutter
- 10" Alligator (Self-Gripping) Pliers
- 4" Slotted Screwdriver
- 6" Slotted Screwdriver
- 4" Phillips #2 Screwdriver Handle Is Uniquely Comfortable in Your Hands and Won't Slip Away

NEW



BONUS

Screwdriver Set
 SKU 447158 | 25945
 Value: \$16.99



with Purchase of:
8 Piece Screwdriver Set
 SKU 127934 | 22970

8 Piece Screwdriver Set

SKU 127934 22970
65⁹⁹

- Magnetic Tips for Gripping Power
- Sand Blasted Tips Resist Chrome Flaking
- Unique Hex Shaped Shafts for More Torque Power
- Set Includes: #2x1-1/2", #2x4", #1x3", #1/4x1-1/2", 3/16x3", 1/4x4", 5/16x6", 3/8x8"
- Patented 3 Sided Handle Is Uniquely Comfortable in Your Hands and Won't Slip Away



Offer Good Thru September 30, 2016 - While Supplies Last

Breaker Bars



3/4" Drive 39" Breaker Bar

SKU 989265 BB40
49⁹⁹

- 39" for Maximum Torque



1/2" Drive 18" Breaker Bar

SKU 914045 72-123
12⁹⁹

- STORE STOCK
- Ball Retainer
- Flex Drive



1/2" Drive 24" Breaker Bar

SKU 914046 72-121
21⁹⁹

- STORE STOCK
- 24" for Maximum Torque



Bolt Cutters

- Forged S2 Steel Construction for Cutting Power
- Hardened Cutting Edge for Long Life
- Ergonomic Comfort Grip Handles

24" Bolt Cutters
 SKU 025213 BC24
19⁹⁹



30" Bolt Cutters
 SKU 965828 BC30
24⁹⁹



36" Bolt Cutters
 SKU 965827 BC36
29⁹⁹



AT OEMTOOLS, we know the tools in your tool box are important. In fact, having the right tools can be a matter of pride. OEMTOOLS is a line of hand tools that combines the best quality and features of traditional hand tools with today's advanced engineering knowledge.

SAVE UP TO \$90

RingStop Reversible Ratcheting Wrench Set

- Patented RingStop Design Makes One Hand Use Easy
- Posi-Lock No-Slip Grip® Design
- Jaw Is 15° Offset
- Made with Chrome Vanadium Steel

Now in Soft Foam EVA Trays!

12 Piece (Metric)

SKU 803140
23988 **159⁹⁹** REG: \$249.99

- Metric Sizes: 8, 9, 10, 11, 12, 13, 14, 15, 16, 17, 18 and 19 mm



8 Piece (SAE)

SKU 803139
23989 **119⁹⁹** REG: \$199.99

- SAE Sizes: 5/16", 3/8", 7/16", 1/2", 9/16", 5/8", 11/16" and 3/4"



12 Piece Go Thru Socket Set (Metric)

SKU 807945
22978 **29⁹⁹**

- Metric Sizes: 8, 9, 10, 11, 12, 13, 14, 15, 16, 17, 18 and 19 mm



8 Piece Go Thru Socket Set (SAE)

SKU 807946
22979 **19⁹⁹**

- SAE Sizes: 5/16", 3/8", 7/16", 1/2", 9/16", 5/8", 11/16" and 3/4"



Patented RingStop Design

The OEMTOOLS® RingStop Reversible Ratcheting Wrench has a patented ring on the box end to stop the spanner from slipping past the fastener. Unlike traditional stop features, the RingStop can be pushed past the fastener head when necessary. This unique design is ideal for use with double nut, or bolt and nut configurations, as well as, socket and bit adaptors.

The Gothru sockets match the head size of each spanner, allowing access to smaller working areas. Ideal for use with inset fasteners, fasteners in tight areas and long bolts. The RingStop can also be used with socket and bit adaptors, increasing the versatility of the tool.



ASK YOUR AUTOZONE COMMERCIAL SALES MANAGER FOR A DEMONSTRATION OF HOW THE OEMTOOLS® RINGSTOP WORKS

31 Piece 3/8" Drive Mechanic's Set

SKU 802210
23998 **99⁹⁹** REG: \$149.99

- Magnetic Spark Plugs
- Featuring OEMTOOLS® 36 Teeth Sealed Head 3/8" Ratchet
- Shallow Sockets: 6-Pt: 8, 9, 10, 11, 12, 13, 14, 15, 16, 17, 18 and 19 mm
- 3/8" Dr. Deep Sockets: 6-Pt: 8, 9, 10, 11, 12, 13, 14, 15, 16, 17, 18 and 19 mm
- 3/8" Wobble Extensions: 3", 6" and 12"
- 3/8" Universal Joint
- 3/8" Spark Plugs: 5/8" and 9/16"



SEALED HEAD MECHANISM
Ratchet heads are sealed to keep dirt and debris out. Heads are fully re-buildable and repair parts are available.

11 Piece Punch and Chisel Set

SKU 802227
23996 **34⁹⁹** REG: \$59.99

- Tapered Punches: 3/32" x 8 mm x 5-1/4", 5/32" x 10 mm x 6", 3/16" x 12 mm x 6-1/4"
- 3 Pc. Pin Punches: 3/32" x 8 mm x 4-1/4", 5/32" x 10 mm x 5, 3/16" x 10 mm x 5-1/4"
- Center Punches: 3/16" x 12 mm x 6
- Cold Chisels: 3/8" x 8 mm x 5-1/2, 1/2" x 10 mm x 6, 5/8" x 12 mm x 6-1/2"
- 1 Gauge



8 Piece Mechanic's Screwdriver Set

SKU 802208
23999 **59⁹⁹** REG: \$79.99

- Slotted: 1/4" x 1-1/2", 3/16" x 3", 1/4" x 4", 5/16" x 6" and 3/8" x 8"
- Phillips: #2 x 1.5", #1 x 3" and #2 x 4"



BLACK MAGNETIC TIP
HEX BOLSTER
Hex shaped bolster for when you need more turning power
UNIQUE ERGONOMIC HANDLE
3 sided handle feels good in your hands

26 Piece Master Hex Bit Set

SKU 802219
23990 **54⁹⁹** REG: \$79.99

- 1/4" Drive: 1/8", 5/32", 3/16" and 7/32"
- 3/8" Drive: 1/4", 9/32", 5/16" and 11/32"
- 1/2" Drive: 3/8", 1/2", 9/16", 3/4" and 5/8"
- 1/4" Drive: 2.5, 3, 4 and 5 mm
- 3/8" Drive: 6, 7, 8 and 9 mm
- 1/2" Drive: 10, 12, 14, 17 and 19 mm



CHAMFERED ENDS
Chamfered ends on bits and sockets make fastener engagement quick and smooth
STRENGTH
Made with S-2 steel
CONTROL
Knurling position is optimized for finger tip control
QUICK ID
Deep markings won't wear off with extended use

16 Piece Combo Wrench Set (Metric)

SKU 802224
23994 **129⁹⁹** REG: \$179.99

- Metric Sizes: 6, 7, 8, 9, 10, 11, 12, 13, 14, 15, 16, 17, 18, 19, 21 and 22 mm



SAVE \$50

14 Piece Combo Wrench Set (SAE)

SKU 802222
23993 **129⁹⁹** REG: \$179.99

- SAE Sizes: 1/4", 5/16", 3/8", 7/16", 1/2", 9/16", 5/8", 11/16", 3/4", 7/8", 15/16", 1", 1-1/16" and 1-1/8"



SAVE \$50

TURNING POWER
Open end has a 15° offset so you can flip it quickly for a new bite

Offers Good Through September 30, 2016 - While Supplies Last

EVA Trays

35 Piece Multi-Drive Star Socket Set

SKU 802217
23991 **44⁹⁹**

- 1/4" Drive Star: T10, T15, T20, T25, T27 and T30
- 1/4" Drive Tamper-Proof Star: T7, T8, T9, T10, T15, T20, T25 and T30
- 1/4" Drive Female Star: E4, E5, E6, E7 and E8
- 3/8" Drive Star: T40, T45, T47, T50 and T55
- 3/8" Drive Tamper-Proof Star: T40, T45, T50 and T55
- 3/8" Drive Female Star: E10, E12, E14 and E16
- 1/2" Drive Star: T60 and T70
- 1/2" Drive Female Star: E18



44 Piece Multi-Drive Star Socket Set

SKU 802206
23992 **49⁹⁹**

- 1/4" Bit Holder
- 1/4" Hex Drive Tamper-Proof Star Bits: T7, T8, T9, T10, T15, T20, T25, T27 and T30
- 1/4" Drive Star: T10, T15, T20, T25, T27 and T30
- 3/8" Drive Star: T40, T45, T47, T50, T55 and T60
- 3/8" Drive Metric Hex: 2, 2.5, 3, 4, 5, 6, 7, 8 and 10 mm
- 3/8" Drive SAE Hex: 1/8", 5/32", 3/16", 7/32", 1/4", 5/16" and 3/8"
- 3/8" Drive Phillips: #1, #2 and #3
- 3/8" Drive Slotted: 3/16", 1/4" and 5/16"



64 Piece 1/4 In. Drive Mechanic's Set

SKU 020788
23997 **199⁹⁹**

- Shallow Sockets, 6 Pt: 4, 4.5, 5, 5.5, 6, 7, 8, 9, 10, 11, 12, 13, 14 and 15 mm
- 1/4" Dr. Deep Sockets, 6 Pt: 4, 4.5, 5, 5.5, 6, 7, 8, 9, 10, 11, 12, 13, 14 and 15 mm
- 1/4" Dr. Wobble Straight Extension
- 1/4" x 1/4" Extension
- Bit Extension Bars: 6" and 10"
- Ratchet Screwdriver
- 28 Bits: Square: 1, 2, 3; Slotted: 6-8, 8-10, 10-12, 1/4; Phillips: #1, #1, #2, #2, #2, #3; Torx: T8, T10, T15, T20, T25, T27, T30; Torx Tamper: TT8, TT10, TT15, TT20, TT25, TT27, TT30
- 1/4" Dr. Universal Joint
- 1/4" Dr. Ratchet



EVA TRAYS
Features a Hard Top Carbon Fiber Style Finish that Makes for a Life Long Lasting Tray.

7 Piece Locking Pliers Set

SKU 012622
23987 **119⁹⁹**

- Sizes: 4", 5", 7", 10" curved jaw and 4", 6", 9" long nose

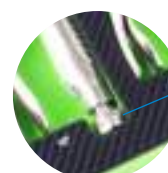

HEX SCREW
Allows more tightening and releasing pressure.



TOOL of the MONTH
JULY
SEE INSERT FOR DETAILS

SAVE \$20

General Service Tool Sets

- EVA Trays Are Designed to Fit Securely in a Cabinet or Tool Box
- Custom Cut of the Tray Is a Hi-Vis Green Making Tools More Visible

- OEMTOOLS Are Made with Unique Alloy Steel That Is Heat-Treated for Extra Strength and Longevity
- OEMTOOLS Feature a Hard Chrome Finish Which Has a Smooth, Satin Finish that Won't Show Prints and Protects Against Rust

KNURLED BASE FOR FIRMER GRIP
CHAMFERED ENDS
Chamfered ends on bits and sockets make fastener engagement quick and smooth

10 Piece 1/4" Deep SAE Socket Set in EVA Tray

SKU 850056
23985 **44⁹⁹**

- Includes Sizes: 3/16", 7/32", 1/4", 9/32", 5/16", 11/32", 3/8", 7/16", 1/2" and 9/16"



12 Piece 1/4" Deep Metric Socket Set in EVA Tray

SKU 850510
23986 **44⁹⁹**

- Includes Sizes: 5, 5.5, 6, 7, 8, 9, 10, 11, 12, 13, 14 and 15 mm



NEW Professional Technician Master Assortments

Laser-Cut Durable EVA Storage Trays Drop Right Into Your Toolbox or Tool Chest!!!

- High Quality Tools That Meet Or Exceed ANSI Standards
- Easy to Identify and Inventory Your Tools
- Comprehensive Size Coverage with Zero Duplication



High Visibility Sockets



14 Pc. Mirror Polished Wrench Set - SAE
SKU 463615 919000 **129⁹⁹**

- Content Sizes: 1/4" - 1-1/8"

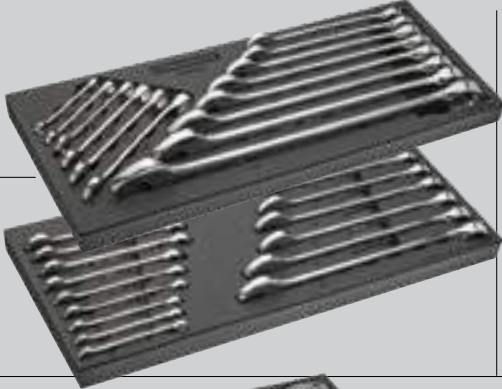

11 Pc. Reversible Ratcheting Wrench Set - SAE
SKU 850226 949015 **99⁹⁹**

- Content Sizes: 1/4" - 7/8"



3 Pc. Tech Ratchet Set
SKU 850518 649967 **99⁹⁹**

Contents:
1/4", 3/8" & 1/2" Drive
- 72 Tooth Gear to Gear Tear Drop Head Ratchet



16 Pc. Mirror Polished Wrench Set - Metric
SKU 463244 949001 **119⁹⁹**

- Content Sizes: 6 - 22 mm (excludes size 20 mm)

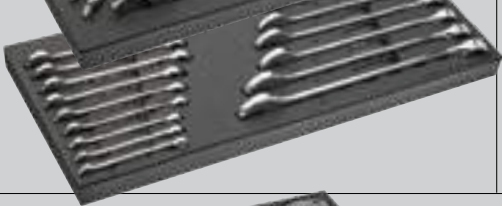

11 Pc. Reversible Ratcheting Wrench Set - Metric
SKU 850227 949016 **99⁹⁹**

- Content Sizes: 8 - 18 mm

17 Pc. Master Screwdriver Set (Acetate Handles)
SKU 463616 949017 **139⁹⁹**

Contents:
- Slotted 1/8" - 3/8" - Phillips #0 - #3
- Lengths from 3" - 8"



17 Pc. Master Screwdriver Set (Injection Grip Handles)
SKU 463618 949018 **139⁹⁹**

Contents:
- Slotted 1/8" - 3/8" - Phillips #0 - #3
- Lengths from 3" - 8"



7 Pc. Master Star Driver Set (Acetate Handles)
SKU 463619 949019 **59⁹⁹**

Content Star Sizes: T-10 - T40



7 Pc. Master Star Driver Set (Injection Grip Handles)
SKU 463621 949020 **59⁹⁹**

Content Star Sizes: T-10 - T40



8 Pc. Professional Mechanics Pliers Set
SKU 463622 949023 **179⁹⁹**

Contents:
- 6" End Nipper Pliers - 7" Linesman Pliers
- 8" Slip Joint Pliers - 9-1/2" Groove Joint Pliers
- 6 In. & 8 In. Diagonal Pliers
- 6 In. & 8 In. Long Nose Pliers



4 Pc. Long Reach Pliers Set
SKU 463623 919024 **119⁹⁹**

Content:
- 11" Long Reach Long Nose Pliers
- 11" 90-degree Long Reach Pliers
- 11" Long Nose Hose Jaw Pliers
- 11" 45-Degree Long Reach Pliers



64 Pc. Hex/Star/Specialty Bit Socket Set
SKU 463611 949010 **229⁹⁹**

Contents:
- Hex Bit Sockets SAE 3/8" Drive: 1/8", 5/32", 3/16", 7/32", 1/4", 5/16", 3/8", 7/16"
- Hex Bit Sockets MM 3/8" Drive: 3, 4, 5, 6, 7, 8, 9, 10 mm
- Star Bit Sockets 3/8" Drive: T-15, T-20, 25, T-27, T-30, T-40, T-45, T-47, T-50, T-55, T-60, T-70
- Tamper Proof Star Bit Sockets 1/4" Drive: T-7, T-8, T-10, T-15, T-20, T-25, T-27, T-30
- 4" Length Hex Bit Sockets SAE 3/8" Drive: 7/32", 1/4", 5/16", 3/8"
- 4" Length Hex Bit Sockets MM 3/8" Drive: 6, 7, 8, 10 mm
- 4" Length Star Bit Sockets 3/8" Drive: T-40, T-45, T-47, T-50
- 4" Length Star Bit Sockets 3/8" Drive: T-40, T-45, T-47, T-50
- E-Star Sockets 1/4" Drive: E-4, E-5, E-6, E-7, E-8
- E-Star Sockets 3/8" Drive: E-4, E-6, E-7, E-8, E-10, E-11, E-12, E-14, E-16, E-18, E-20, T-7, T-8, T-10, T-15, T-20, T-25, T-27, T-30
- 4" Length Hex Bit Sockets SAE 3/8" Drive: 7/32", 1/4", 5/16", 3/8"
- 4" Length Hex Bit Sockets MM 3/8" Drive: 6, 7, 8, 10 mm
- 4" Length Star Bit Sockets 3/8" Drive: T-40, T-45, T-47, T-50
- E-Star Sockets 1/4" Drive: E-4, E-5, E-6, E-7, E-8
- E-Star Sockets 3/8" Drive: E-4, E-6, E-7, E-8, E-10, E-11, E-12, E-14, E-16, E-18, E-20



47 Pc. 1/4" Dr. Master Socket Set - SAE & Metric
SKU 463243 949004 **119⁹⁹**

Contents:
- Shallow 6 Pt. SAE Sockets: 5/32" - 1/2" (10 pc. sockets)
- Shallow 6 Pt. Metric Sockets: 4 - 13 mm (12 pc. sockets)
• Includes (4.5 & 5.5 mm sockets)
- Deep 6 Pt. SAE Sockets: 5/32" - 1/2" (10 pc. sockets)
- Deep 6 Pt. Metric Sockets: 4 - 13 mm (11 pc. sockets)
• Includes (4.5 mm socket)
- 72 Tooth Gear to Gear Tear Drop Head Ratchet
- 3" & 6" Extensions and Universal Joint Included



69 Pc. 1/2" Dr. Master Socket Set - SAE & Metric
SKU 463427 949606 **299⁹⁹**

Contents:
- Shallow 12 Pt. SAE Sockets: 3/8" - 1-1/4" (15 pc. sockets)
- Shallow 12 Pt. Metric Sockets: 6 - 27 & 30 mm (19 pc. sockets)
- Deep 6 Pt. SAE Sockets: 3/8" - 1-1/4" (14 pc. sockets) (excludes 1-3/16")
- Deep 6 Pt. Metric Sockets: 10 - 24 mm (15 pc. sockets)
- 72 Tooth Gear to Gear Tear Drop Head Ratchet
- 12" Length 1/2" Dr. Flex Handle
- 3", 5" & 10" Extensions and Universal Joint Included



54 Pc. 3/8" Dr. Master Socket Set - SAE & Metric
SKU 463245 949005 **159⁹⁹**

Contents:
- Shallow 12 Pt. SAE Sockets: 3/8" - 7/8" (9 pc. sockets)
- Shallow 12 Pt. Metric Sockets: 6 - 19 mm (14 pc. sockets)
- Deep 6 Pt. SAE Sockets: 5/16" - 7/8" (10 pc. sockets)
- Deep 6 Pt. Metric Sockets: 6 - 19 mm (14 pc. sockets)
- Spark Plug SAE sockets: 5/8" & 13/16"
- 72 Tooth Gear to Gear Tear Drop Head Ratchet
- 3", 6" & 8" Extensions and Universal Joint Included



85 Pc. 1/4", 3/8" & 1/2" Dr. Master Socket Set - Metric
SKU 463609 949008 **219⁹⁹**

Contents:
- 1/4" Dr. Shallow 6 Pt. Metric Sockets: 4 - 13 mm (12 pc. sockets) (Includes 4.5 & 5.5 mm Sockets)
- 1/4" Dr. Deep 6 Pt. Metric Sockets: 4 - 13 mm (11 pc. sockets) (Includes 4.5 mm Socket)
- 3/8" Dr. Shallow 12 Pt. Metric Sockets: 6 - 19 mm (14 pc. sockets)
- 3/8" Dr. Deep 6 Pt. Metric Sockets: 6 - 19 mm (14 pc. sockets)
- 1/2" Dr. Shallow 12 Pt. Metric Sockets: 6 - 27 & 30 mm (19 pc. sockets)
- 1/2" Dr. Deep 6 Pt. Metric Sockets: 10 - 24 mm (15 pc. sockets)

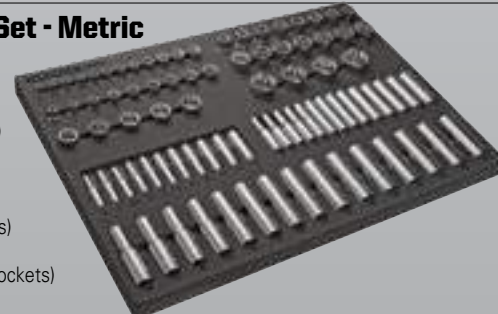

70 Pc. 1/4", 3/8" & 1/2" Dr. Master Socket Set - SAE
SKU 463246 949007 **219⁹⁹**

Contents:
- 1/4" Dr. Shallow 6 Pt. SAE Sockets: 5/32" - 1/2" (10 pc. sockets)
- 1/4" Dr. Deep 6 Pt. SAE Sockets: 5/32" - 1/2" (10 pc. sockets)
- 3/8" Dr. Shallow 12 Pt. SAE Sockets: 3/8" - 7/8" (9 pc. sockets)
- 3/8" Dr. Deep 6 Pt. SAE Sockets: 5/16" - 7/8" (10 pc. sockets)
- Spark Plug SAE Sockets: 5/8" & 13/16"
- 1/2" Dr. Shallow 12 Pt. SAE Sockets: 3/8" - 1-1/4" (15 pc. sockets)
- 1/2" Dr. Deep 6 Pt. SAE Sockets: 3/8" - 7/8" (14 pc. sockets)
• (excludes 1-3/16")



40 Pc. 3/8" Dr. Master Impact Socket & Accessories Set - SAE & Metric
SKU 463613 949011 **249⁹⁹**

Contents:
- Shallow SAE Impact Sockets: 3/8" - 3/4" (7 pc. sockets)
- Shallow Metric Impact Sockets: 10 - 19 mm (10 pc. sockets)
- Deep SAE Impact Sockets: 3/8" - 7/8" (9 pc. sockets)
- Deep Metric Impact Sockets: 10 - 21 mm (11 pc. sockets)
• (excludes 20 mm socket)
- 3" Extensions, Universal Joint & Adapter Included



62 Pc. 1/2" Dr. Master Impact Socket & Accessories Set - SAE & Metric
SKU 463614 949012 **449⁹⁹**

Contents:
- Shallow SAE Impact Sockets: 7/16" - 1-1/4" (13 pc. sockets)
- Shallow Metric Impact Sockets: 13 - 24 & 27 mm (16 pc. sockets)
- Deep SAE Impact Sockets: 7/16" - 1-1/4" (13 pc. sockets)
- Deep Metric Impact Sockets: 13 - 24 & 26 mm (11 pc. sockets)
• (excludes 18 mm socket)
- 3" & 5" Extensions, Universal



HAND TOOLS

Socket Sets

Pro Series 10 Piece 1/2" Drive Metric Socket Set

SKU 005716 **44⁹⁹**
GRP00501

- Socket Sizes: M10, M11, M12, M13, M14, M15, M16, M17, M18, M19
- Dual-Flip Storage Case
- Socket Exceed ANSI Strength Requirements
- Chrome Vanadium Forged Steel
- Black Oxide Coated Cams



Pro Series 7 Piece 1/2" Drive SAE Socket Set

SKU 005714 **44⁹⁹**
GRP00502

- Socket Sizes: 3/8", 7/16", 1/2", 9/16", 5/8", 11/16", 3/4"
- Dual-Flip Storage Case
- Socket Exceed ANSI Strength Requirements
- Chrome Vanadium Forged Steel
- Black Oxide Coated Cams



GRIP-TITE

Wrenches

Pro Series 6 Piece Metric Wrench Set

SKU 042363 **54⁹⁹**
GRP00511

- Set Includes 12mm, 13mm, 14mm, 15mm, 17mm, and 18mm Sizes
- Exceed ANSI Strength Requirements
- Chrome Vanadium Forged Steel
- Black Oxide Coated Cams



Pro Series 6 Piece SAE Wrench Set

SKU 042342 **54⁹⁹**
GRP00515

- Set Includes 7/16 In., 1/2 In., 9/16 In., 5/8 In., 11/16 In., and 3/4 In. Sizes
- Exceed ANSI Strength Requirements
- Chrome Vanadium Forged Steel
- Black Oxide Coated Cams



GRIP-TITE

NEW

10" Straight Jaw Tongue and Groove Pliers

SKU 019254 **21⁹⁹**
CHA430

- Right Angle, Laser Heat Treated Teeth Grip Better and Last Longer
- 2" Jaw Capacity
- Constructed from C1080 Steel for Superior Performance
- Reinforcing Edge Minimizes Stress Breakage



4.5" Straight Jaw Tongue and Groove Pliers

SKU 019246 **16⁹⁹**
CHA424

- Right Angle, Laser Heat Treated Teeth Grip Better and Last Longer
- 0.50" Jaw Capacity
- Constructed from C1080 Steel for Superior Performance
- Reinforcing Edge Minimizes Stress Breakage



2 Piece Oil Filter Pliers Set

SKU 019253 **44⁹⁹**
CHAOF-2

- Fastener That Eliminates Nut and Bolt Failure
- Plier Capacity is 3.5" (89 mm) and 4.25" (108 mm)
- Overall Length is 9" (225 mm) and 12" (300 mm)
- Plier Slot Adjustments 4 and 5
- Useful on PVC, Conduit, Filter Casing and Basket Stainers



CHAN NET LOCK

NEW

9.5" Crimping Tool with Cutter

SKU 019270 **22⁹⁹**
CHA909

- Lead Plier Nose Pulls and Loops Wire
- Cuts and Crimps 10-22 AWG Wire
- Laser Heat Treated Cutting Edges Last Longer
- Constructed of High Carbon Steel

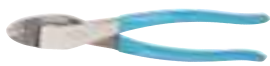

9" Rescue Tool

SKU 091685 **49⁹⁹**
CHA86

- Jaw Design Accommodates Many Shapes and Provides Maximum Grip
- Spring and Lock Feature Allows One-Handed Operation
- Ability to Shut Off Gas Safety Valves and Pry Open Windows and Doors
- Spanner Wrench That Tightens Up to 5" Hose Couplings



7.75" Curved Jaw Diagonal Cutting Pliers

SKU 019260 **24⁹⁹**
CHA447

- Laser Heat Treated Teeth Grip Better and Last Longer
- Knife and Anvil Style Cutting Edge
- Overall Length: 7.75 In. (195 mm)
- Cutting Edge 1.02 In. (26 mm)



6.5" Straight Jaw Tongue and Groove Pliers

SKU 019251 **19⁹⁹**
CHA426

- Right Angle, Laser Heat Treated Teeth Grip Better and Last Longer
- 0.87" Jaw Capacity
- Constructed from C1080 Steel for Superior Performance
- Reinforcing Edge Minimizes Stress Breakage



12" Straight Jaw Tongue and Groove Pliers

SKU 019264 **24⁹⁹**
CHA440

- Right Angle, Laser Heat Treated Teeth Grip Better and Last Longer
- 2.25" Jaw Capacity
- Constructed from C1080 Steel for Superior Performance
- Reinforcing Edge Minimizes Stress Breakage



5 Piece Pro Pliers Set

SKU 019250 **74⁹⁹**
CHATOOL ROLL-3

- Set Includes: 9.5" and 10" Tongue and Groove Pliers, 7" HL Diag Cutting Plier, 8" Long Nose and 6.5" Slip Joint Plier

3PC Cobra® Pliers Set

SKU 505075 **119.99**
KNP002006US1

- Set includes: 7 1/4", 10", 12"
- Push-button adjustment directly on the workpiece
- Self-locking means no slipping off the workpiece
- Gripping surface with special, hardened teeth (approximately 61 HRC)
- Grips any shaped object: round, square, hex or flat
- Thin head fits into tight places



KNIPLEX

8" High Leverage Diagonal Cutter

SKU 080087 **34.99**
KNP7401200

- Forged axle-rivet joint ensures smooth operation
- Long and precise induction-hardened cutting edges (approximately 64 HRC) for extra long life and effortless cutting of hardened wire



KNIPLEX



KNIPLEX Quality – Made in Germany

NEW

3PC Universal Set w/Cobra®

SKU 505070 **89.99**
KNP002008US2

- Perfect variety set for your most demanding jobs
- Set includes:
 - 8" Long Nose Pliers
 - 8" High Leverage Diagonal Pliers
 - 10" Cobra Water Pump Pliers



KNIPLEX

10" High Leverage Diagonal Cutter

SKU 080088 **49.99**
KNP7401250

- High leverage for a 33% cutting advantage
- Forged axle-rivet joint ensures smooth operation
- Long and precise induction-hardened cutting edges (approximately 64 HRC) for extra long life and effortless cutting of hardened wire



KNIPLEX

10" Alligator® Water Pump Pliers

SKU 079755 **32.99**
KNP8801250

- Self-locking means no slipping off of the workpiece
- Gripping surface with special hardened teeth (approximately 61 HRC)
- Grips any shaped object: round, square, hex or flat
- Forged box-joint design for high stability
- Thin head fits into tight places



KNIPLEX

6-in-1 Electrical Installation Tool

SKU 043055 **69.99**
KNP13818

- 6 functions in one pair of pliers: cutting, stripping, crimping, gripping, bending and deburring
- Slim long nose design for easy access into tight places
- Bolted joint for precision smooth action



KNIPLEX

10" Hose Clamp Pliers

SKU 011614 **84.99**
KNP8551250ASB

- Rotatable tips for reliably gripping hose clamps up to 2 3/4" diameters from all angles
- Thin head gets into tight places
- Quick-set adjustment: adjusts by shifting the bottom jaw up directly on the workpiece



KNIPLEX

8" Battery Cable Cutter

SKU 080091 **59.99**
KNP9511200

- For cutting copper and aluminum cables
- Not suitable for ACSR, steel wire and hard drawn copper conductors
- Dual jaws allow thicker cables to be stripped and then cut in a two step process



KNIPLEX

8" Mini Bolt Cutter w/notch

SKU 042478 **59.99**
KNP7131200

- Cuts hard wire, steel rods, fencing and bolts
- Cutting edge hardness 64 HRC
- Recess in blade for easier cutting
- 20-to-1 compound joint ratio = 60% less effort is required during cutting

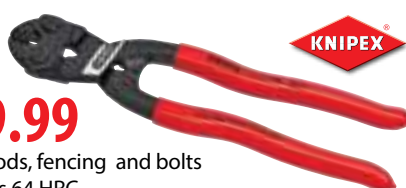

KNIPLEX

5" Cobra® Water Pump Pliers

SKU 080102 **34.99**
KNP8701125

- Push-button adjustment directly on the workpiece
- Self-locking means no slipping off the workpiece
- Gripping surface with special, hardened teeth (approximately 61 HRC)
- Grips any shaped object: round, square, hex or flat
- Thin head fits into tight places



KNIPLEX

5PC Double Edge Bolt and Screw Extractor Set

SKU 042353 **59.99**
KNP9R4719043

- Four-double edged cutting / gripping edges = 8 points of contact
- For both left and right-handed threads
- Tip has built-in center punch
- Non-slip engagement removes even the toughest frozen bolts



KNIPLEX



Contact Us:
1-877-AZTool1 Phone
 (1-877-298-6651) *Hablamos Español*

STAINLESS STEEL TUMBLERS

Perfect For The Office, Work, Camping, Garage and Home



NEW



10 Oz. Chuck

SKU 096882
 Part# 26010
 Price \$19.99 REG. \$24.99

SAVE \$5



20 Oz. Hammer

SKU 096878
 Part# 26009
 Price \$19.99 REG. \$24.99

SAVE \$5

- Made with Durable Kitchen-Grade 18/8 Stainless Steel
- Double-wall Vacuum Insulation Keeps Drinks Cold or Hot to the Last Sip
- No Sweat Design Keeps Fingers Dry and Comfortable
- BPA Free



Tumbler Box Set

SKU 096887
 Part# 26014
 Price \$59.99 REG. \$69.99

SAVE \$10

Perfect For:

- ✓ Coffee
- ✓ Juice
- ✓ Soda
- ✓ Energy Drinks



30 Oz. Jackhammer

SKU 096881
 Part# 26008
 Price \$24.99 REG. \$29.99

SAVE \$5



Keeps Ice 2x Longer Than Plastic Tumblers!

Offers Good Thru September 30, 2016 - While Supplies Last

SureFire

- SureFire Offers Over 4,000 SKUs!
- Cylinder Heads are Next-Day Shipping
- It Takes 3-5 Days to Ship Engines and Differentials on Most Applications

PROformance
 VFDV 5.4L Ford



RAX2080A
 Chevy 2500
 3.73 GR



DCT8 5.3L GM



2547R 3.5L
 Honda

If Quality, Reliability and Customer Service are Important to You...

- SureFire Engines and Rear Axles come with a 3-year unlimited mileage warranty. Our Cylinder Heads carry a 12-month, 12,000 mile warranty.
- Our exclusive PROformance Engines are a more complete dressed engine and include the front timing cover, oil pan, oil pump and pick up tube, and in most cases the valve covers.
- PROformance Engines carry a 3-year unlimited mile "No Fault" Warranty – the best coverage in the industry!

It All Means SureFire Puts the Customer First!

UNIFORMS

View Product Information www.1-stopworkwear.com
To Place an Order Call Your AutoZone Commercial Sales Manager
For Product Information Call 1-855-275-1403

TAKE ADVANTAGE OF THE DICKIES ADVANTAGE

Quality Since 1922, Durable, Comfortable & Great Value



Dickies Auto Tech Work Shirt

- Button Front Shirt; One Snap Closure at Neck
- Mitered Front Pockets with Pencil Division on Left Pocket
- Fade Resistant

(Small to 4XL) 65% Polyester/35% Cotton	Short Sleeve 1SSS535	Long Sleeve 1SL535
Item Only	17 ⁹⁹	19 ⁹⁹
Item + Shop Name	22 ⁹⁹	24 ⁹⁹
Item + Employee Name	24 ⁹⁹	26 ⁹⁹
Item + Shop + Employee Name	29 ⁹⁹	31 ⁹⁹



Define Your Custom Look

- Shop Name - Embroider the Left Chest of Any Work Shirt. Designate the Item Number, Text and Text Color
- Employee Name - Personalize the Right Chest of Any Work Shirt
- Includes Up to 10 Characters Per Line, 2 Line Limit

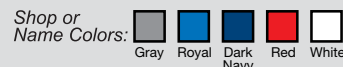

Dickies Color Block Auto Shirt

(S to 4XL)
65% Polyester/
35% Cotton

- Mitered Front Pockets with Pencil Division on Left Pocket
- Fade Resistant
- Industrial Laundry Friendly



(Small to 4XL) 65% polyester/35% cotton	Short Sleeve 1SSS524	Long Sleeve 1SL524
Item Only	29 ⁹⁹	31 ⁹⁹
Item + Shop Name	34 ⁹⁹	36 ⁹⁹
Item + Employee Name	36 ⁹⁹	38 ⁹⁹
Item + Shop + Employee Name	41 ⁹⁹	43 ⁹⁹

Dickies WorkTech Ventilated Performance Shirt

(M to 5XL)
65% Polyester/
35% Cotton

- Easy Care Stain Release
- Moisture Wicking
- Flex Fabric for Comfort and Mobility
- 4.2 Oz Mechanical Stretch Poplin Side and Back Mesh Panels



Item Only	34 ⁹⁹
Item + Shop Name	39 ⁹⁹
Item + Employee Name	41 ⁹⁹
Item + Shop + Employee Name	46 ⁹⁹

Dickies Performance Polo

(S to 5XL)
100% Polyester

- Easy Care Stain Release
- Moisture Wicking
- Side Vents
- Snag Resistant



Item Only	26 ⁵⁰
Item + Shop Name	31 ⁵⁰
Item + Employee Name	33 ⁵⁰
Item + Shop + Employee Name	38 ⁵⁰

Dickies Color Block Performance Polo

(S to 5XL)
100% Polyester

- Easy Care Stain Release
- Moisture Wicking
- Side Vents
- Snag Resistant



Item Only	26 ⁵⁰
Item + Shop Name	31 ⁵⁰
Item + Employee Name	33 ⁵⁰
Item + Shop + Employee Name	38 ⁵⁰

Dickies Performance Shop Shirt

(S to 5XL)
65% Polyester/
35% Cotton

- Easy Care Stain Release
- Moisture Wicking
- Resists Wrinkles
- 4.6 Oz Flexwill
- Available in Long Sleeve



Item Only	33 ⁹⁹
Item + Shop Name	38 ⁹⁹
Item + Employee Name	40 ⁹⁹
Item + Shop + Employee Name	45 ⁹⁹

Dickies Performance Tee

(M to 5XL)
85% Polyester/
15% Cotton

- Dri Release, Resists Pulling & Wrinkles
- Resists Stains
- Jersey Knit with Wicking



Item Only	25 ⁹⁹
Item + Shop Name	30 ⁹⁹
Item + Employee Name	32 ⁹⁹
Item + Shop + Employee Name	37 ⁹⁹

Dickies Eisenhower Jacket

(S to 5XL)
1SJ14

- Lightweight but Warm
- Durable
- Water Repellent
- Adjustable Waist Tabs

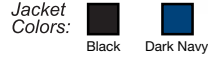

Item Only	55 ⁹⁹
Item + Shop Name	60 ⁹⁹
Item + Employee Name	62 ⁹⁹
Item + Shop + Employee Name	67 ⁹⁹

Worktech Ventilated Polo

(S to 5XL)
100% Polyester

- 6 Oz Micro Pique
- 4.7 Oz Performance Mesh
- Easy Care Stain Release
- Resists Wrinkles, Snags and Fading

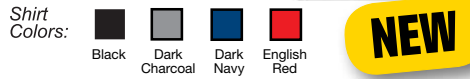

Item Only	29 ⁹⁵
Item + Shop Name	34 ⁹⁵
Item + Employee Name	36 ⁹⁵
Item + Shop + Employee Name	41 ⁹⁵

Dickies Shop Pant

65% Polyester/35% Cotton
Waist: 30-50 Even Sizes Only
Inseam: 28-36

DICKIES 20⁹⁹

- Relaxed Fit
- StayDark Technology
- Wrinkle/Stain Resistant



Dickies Blended Coverall

(Small to 4XL)
65% Polyester/35% Cotton

- Durable Poly/Cotton
- Easy Care Stain Release
- Two Large Back Pockets

Item Only	45 ⁴⁵
Item + Shop Name	50 ⁴⁵
Item + Employee Name	52 ⁴⁵
Item + Shop + Employee Name	57 ⁴⁵

Dickies Cargo Pant

65% Polyester/35% Cotton
Waist: 30-50 Even Sizes Only
Inseam: 28-36

1SPCARGO 28⁹⁹

- Relaxed Fit
- StayDark Technology
- Wrinkle/Stain Resistant



Dickies Performance Shop Pant

65% Polyester/ 35% Cotton
Waist: 30-50 Even Sizes Only
Inseam: 28-36

1SLP605 37⁹⁹

- Rubberized Scratch Resistant Tack Button Closure
- Easy Care Stain Release
- Cell Pocket
- Double Knee
- 7 1/4 Flex Twill



Dickies Cargo Short

65% Polyester/35% Cotton
Waist: 30-50
Even Size Only
Inseam: 11

1SPCSHORT 28⁹⁹

- Relaxed Fit
- StayDark Technology
- Wrinkle/Stain Resistant



All Hats Come With Shop Name That Includes Up to 10 Characters Per Line with 2 Line Limit. Minimum Purchase = 6

Shop Hats - Only \$5⁰⁰!

Black Hat 1SH03

Black Mesh 1SH01



Khaki Hat with Black or Navy Bill 1SH04



Camo Hat 1SH06 8⁵⁰

Checked Racing Hat with Mesh Back 1SH12 11⁷⁵



Specialty Hats - as Low as \$9⁹⁹!



AutoZone Custom Embroidered Hats

- Thread Color Choices: Black, Royal, Navy, Red, White, Orange, Tan, Grey
- Hats Include Up to 10 Characters Per Line, 2 Line Limit
- Minimum Order is Only 6 Pieces!

Item#	Description	Color	Price
WW415PC	Camo Hat with Camo Mesh Back	Mossy Oak	9 ⁹⁹
WWGL-845	Contrasting Sandwich, Buttons & Eyelet	Black/Red or Navy/White	9 ⁹⁹
WWFWT-130	Heavy Garment Washed, Mesh Back	Black/Dark Grey, Charcoal/White or Black/Tan	10 ⁹⁹
WWGWT-111	Unstructured Garment Washed Twill	Black, Charcoal or Navy	12 ⁹⁹
WWFB-836	OC Hi Beam Mesh Back Hat with Built-In LED Lights	Navy or Black	19 ⁹⁹

PROMOTE YOUR SHOP!

Go to WWW.1-STOPWORKWEAR.COM for product details.

Item#	Description	Price
BKCLICKPEN	Black Click Pen	.90
1SPRO8	Mini Tire Gauge Keychain	1.35
1SPRO7	Metal Key Tag	1.75
AZFLASH	LED Flashlight	4.50
WWBottle	Aluminum Water Bottle	4.50
1SPR11	Matrix Tumbler 18 oz.	7.25
1SPR13	Computer Sing Backpack	29.99



GLOVES



FASTFIT
MFF-05

SKU	PART#	DESCRIPTION	PRICE
244340*	MFF-05-008	FASTFIT GLOVE BLK S	14 ⁹⁹
240886	MFF-05-009	FASTFIT GLOVE BLK M	14 ⁹⁹
240887	MFF-05-010	FASTFIT GLOVE BLK L	14 ⁹⁹
240888	MFF-05-011	FASTFIT GLOVE BLK XL	14 ⁹⁹
244341*	MFF-05-012	FASTFIT GLOVE BLK XXL	14 ⁹⁹

* VDP ONLY

STORE STOCK



ORIGINAL
MG-05

SKU	PART#	DESCRIPTION	PRICE
244356	MG-05-008	ORIG MECH GLOVE BLK S	19 ⁹⁹
240898	MG-05-009	ORIG MECH GLOVE BLK M	19 ⁹⁹
240899	MG-05-010	ORIG MECH GLOVE BLK L	19 ⁹⁹
240900	MG-05-011	ORIG MECH GLOVE BLK XL	19 ⁹⁹
244357	MG-05-012	ORIG MECH GLOVE BLK XXL	19 ⁹⁹

STORE STOCK



M-PACT
MPT-52

SKU	PART#	DESCRIPTION	PRICE
378908*	MPT-52-008	MPACT GLOVES BLK/RED S	24 ⁹⁹
378900	MPT-52-009	MPACT GLOVES BLK/RED M	24 ⁹⁹
378901	MPT-52-010	MPACT GLOVES BLK/RED L	24 ⁹⁹
378902	MPT-52-011	MPACT GLOVES BLK/RED XL	24 ⁹⁹
378903*	MPT-52-012	MPACT GLOVES BLK/RED XXL	24 ⁹⁹

* VDP ONLY

STORE STOCK

THE TOOL THAT FITS LIKE A GLOVE®

Duralast™ PROVEN TOUGH®



MECHANICS
DUR-MG

SKU	PART#	DESCRIPTION	PRICE
461513	DUR-MG-009	DURALAST MECHANIC MD	17 ⁹⁹
461510	DUR-MG-010	DURALAST MECHANIC LG	17 ⁹⁹
461511	DUR-MG-011	DURALAST MECHANIC XL	17 ⁹⁹

STORE STOCK



GRIP
DUR-MGG

SKU	PART#	DESCRIPTION	PRICE
461514	DUR-MGG-010	DURALAST GRIP LG	19 ⁹⁹
461516	DUR-MGG-011	DURALAST GRIP XL	19 ⁹⁹

STORE STOCK



IMPACT
DUR-MP

SKU	PART#	DESCRIPTION	PRICE
461517	DUR-MP-009	DURALAST M-PACT MD	22 ⁹⁹
461518	DUR-MP-010	DURALAST M-PACT LG	22 ⁹⁹
461515	DUR-MP-011	DURALAST M-PACT XL	22 ⁹⁹

STORE STOCK

- PF** POWDER-FREE
- LATEX** LATEX-FREE
- TEXTURED GRIP**
- 2** SINGLE USE ONLY



DUAL SIDED SCALE GRIP



BE SAFE & SEEN WITH

ASTRO GRIP™

POWDER FREE NITRILE GLOVES

- Powder-free nitrile
- Thickness: 6 mil
- Dual-sided scale textured surface for superior grip
- High-visibility safety orange color
- Non-latex
- Exceptional chemical and puncture resistance
- Maximum comfort allows for extended wear
- 100 gloves per box

SKU 823166 17⁹⁹

SAS66572 Medium
STORE STOCK

SKU 823167 17⁹⁹

SAS66573 Large
STORE STOCK

SKU 823168 17⁹⁹

SAS66574 XLarge
STORE STOCK



6 mil NITRILE

INVUE™

DID YOU KNOW?

STP® oil is now available at AutoZone. STP® is a worldwide name that customers know and trust. Buy your STP® oil and filters at your local AutoZone store.

Contact Your AutoZone Commercial Sales Manager for Details

GLOVES

Gloves

Hot Sleeve

SKU 291321 **19⁹⁹**
LIS18700

- Made of Kevlar® to Protect Arms from Burns
- Double Wall Construction for Added Heat Protection
- Work for Either Right or Left Arm
- Sleeve Is Washable



Kevlar Burn Protection Arm Glove

SKU 222467 **25⁹⁹**
LIS21260

- Total Hand and Arm Burn Protection
- Kevlar® Protects Hands and Arms from Hot Surfaces
- Enables Work On Hot Engines and Exhaust Systems without Waiting
- For Right and Left Hands
- Glove Portion Is Coated with a Vinyl Tread for Greater Gripping Power



Magnetic Glove Box Holder

SKU 291322 **29⁹⁹**
LIS20130

- Magnetic Glove Dispenser Conveniently Attaches to Your Toolbox or Any Ferrous Metal Surface
- Two Large Magnets Hold the Dispenser in Place
- Uses Three Springs Which Can Be Adjusted as Necessary to Hold the Various Box Sizes



NOTHING'S TOUGHER THAN STEEL

VENOM STEEL® INDUSTRIAL NITRILE GLOVES

From brakes to body work, tune-ups to transmissions, rip through the filthiest jobs, without ripping through your gloves.

70% THICKER*



19⁹⁹

100 CT BOX

MEDIUM: SKU 847122 VEN6142H
LARGE: SKU 847123 VEN6143H
X-LARGE: SKU 847125 VEN6144H

- Black, 6 mil thick
- Rip, tear & puncture-resistant premium black nitrile
- Fully textured for extra grip
- Powder-free

BEST VALUE 89⁹⁹



500 CT BOX

MEDIUM: SKU 847126 VEN6542
LARGE: SKU 847127 VEN6543
X-LARGE: SKU 847128 VEN6544

- Same high quality black nitrile as the 100 count box
- Great savings for auto shops and contractors

*Compared to Venom® Nitrile Gloves.

VENOM STEEL® INDUSTRIAL LATEX GLOVES

Premium, extra thick natural latex for heavy-duty protection with a great sense of touch.

70% THICKER**



19⁹⁹

100 CT BOX

MEDIUM: SKU 847130 VEN8122H
LARGE: SKU 847131 VEN8123H
X-LARGE: SKU 847124 VEN8124H

- Beige, 8 mil thick
- Ultimate flexibility & comfort
- Textured fingers for better grip
- Touch screen sensitive
- Powder-free

**Compared to Venom® Latex Gloves.



©2016 Medline Industries, Inc. All rights reserved. Venom and Venom Steel is a registered trademark of Medline Industries, Inc.

Disposable Gloves

Black Dragon Gloves (100 Gloves Per Box)

SKU 244622 **16⁹⁹** each
BD100N-L (L)

SKU 244617 **16⁹⁹** each
BD100N-XL (XL)

STORE STOCK

- If you are Working with Tools and Equipment, Consider Black Dragon® Gloves for a More Secure Grip. The Fully Textured Surface Provides Confidence While the Black Color Allows for Better Focus by Hiding Stains.
- Strong and Durable
- Black Color Provides Better Framing Which Increases Eye Focus
- Fully Textured, But Thinner at the Palm and Finger to Provide Greater Sensitivity
- Overall Length: 9.6"
- 4.7 mil Finger, 3.5 mil Palm

If You are Concerned About Tactile Sensitivity, Consider Black Dragon® Zero Gloves Featuring Textured Fingertips. These Gloves Not Only Mask Stains and Provide Better Framing, They are Also Easy to Put On and Wear Comfortably.

Product Attributes: Black Color • Nitrile • Non-Sterile • Ambidextrous Textured Fingertips • Beaded Cuff • For Single Use Only

MICROFLEX
THE MOST TRUSTED NAME IN GLOVES®



Diamond Grip Gloves (100 Gloves Per Box)

SKU 497065 **17⁹⁹** each
MF-300-M (M)

SKU 497064 **17⁹⁹** each
MF-300-L (L)

SKU 497066 **17⁹⁹** each
MF-300-XL (XL)

STORE STOCK

- The Benchmark in Strength and Durability in Latex Gloves. Thicker Than Typical Latex Gloves, Diamond Grip™ Gloves Provide Enhanced Protection, Especially in the Fingertips Where Protection is Critical.
- Unique Design Prevents Ripping and Tearing
- Enhanced, Textured Fingertips for Added Protection and Function
- Ideal for Rugged Tasks in Mid to Heavy-Duty Environments
- Overall Length: 9.8"
- 9.1 mil Finger, 6.3 mil Palm
- 21MPa Tensile Strength
- Low Protein Latex (<= 50 Micrograms/g)

For The Benchmark in Strength and Durability in Latex Gloves, Look No Further Than Diamond Grip. Thicker Than Typical Latex Gloves, Diamond Grip Gloves Provide Enhanced Protection, Especially in The Fingertips Where Protection is Critical.

Product Attributes: Natural Color • Latex • Non-Sterile • Ambidextrous • Textured Fingertips • Beaded Cuff • For Single Use Only

MICROFLEX
THE MOST TRUSTED NAME IN GLOVES®





Contact Us:
1-877-AZTool1 Phone
 (1-877-298-6651) *Hablamos Español*

Disposable Gloves

Value-Touch Latex
5 mil, Light Powder Gloves
 100 Gloves Per Box - 10 Boxes Per Case



1,000 Gloves
 Case (10 Boxes, 100 Ea.), **\$12.99** Per Box

SKU **265076** **129⁹⁹**
 SAS6592CS (M)
 SKU **265079** **129⁹⁹**
 SAS6593CS (L)
 SKU **265068** **129⁹⁹**
 SAS6594CS (XL)

Professional Black Nitrile
4.5 mil, Textured Grip
 100 Gloves Per Box - 10 Boxes Per Case



1,000 Gloves
 Case (10 Boxes, 100 Ea.), **\$12.99** Per Box

SKU **504168** **129⁹⁹**
 SAS66542CS (M)
 SKU **504169** **129⁹⁹**
 SAS66543CS (L)
 SKU **504172** **129⁹⁹**
 SAS66544CS (XL)

Raven Black Nitrile
6 mil, Powder Free
 100 Gloves Per Box - 10 Boxes Per Case



Now Available In XXL



300 Gloves
 3 Boxes of 100 Each, **\$19.99** Per Box

SKU **265057** **59⁹⁹**
 SAS66517PK3 (M)
 SKU **265056** **59⁹⁹**
 SAS66518PK3 (L)
 SKU **265034** **59⁹⁹**
 SAS66519PK3 (XL)
 SKU **80522** **59⁹⁹**
 SAS66520PK3 (XXL)

1,000 Gloves
 Case (10 Boxes, 100 Ea.), **\$16.99** Per Box

SKU **265051** **169⁹⁹**
 SAS66517CS (M)
 SKU **265052** **169⁹⁹**
 SAS66518CS (L)
 SKU **265053** **169⁹⁹**
 SAS66519CS (XL)
 SKU **080516** **169⁹⁹**
 SAS66520CS (XXL)

Derma-Lite Nitrile
5 mil, Light Powder
 100 Gloves Per Box - 10 Boxes Per Case



300 Gloves
 3 Boxes of 100 Each, **\$19.99** Per Box

SKU **222821** **59⁹⁹**
 SAS6607PK3 (M)
 SKU **265037** **59⁹⁹**
 SAS6608PK3 (L)
 SKU **265054** **59⁹⁹**
 SAS6609PK3 (XL)

1,000 Gloves
 Case (10 Boxes, 100 Ea.), **\$16.99** Per Box

SKU **227872** **169⁹⁹**
 SAS6607CS (M)
 SKU **265038** **169⁹⁹**
 SAS6608CS (L)
 SKU **265045** **169⁹⁹**
 SAS6609CS (XL)
 SKU **265050** **169⁹⁹**
 SAS6610CS (XXL)

Nitrile PLM Knit Gloves (1 Dozen)

- Washable and Reusable
- Liquid Dipped 100% Nitrile Palm Coat
- 16 Gauge Seamless Nylon Shell
- Knit Back Helps Keep Hand Cooler Longer



SKU **250887** **39⁹⁹**
 SAS6401909 (L)

SKU **250888** **39⁹⁹**
 SAS6401910 (XL)

SKU **250890** **39⁹⁹**
 SAS6401911 (XXL)

Safety

Nuisance Dust Mask (Box of 50)
 SKU **526952** **16⁹⁹**
 SAS2985

- This One-Size-Fits-All Mask Is Perfect for Home, Farm and Garden Use



Bandit N95 Halfmask Respirator

SKU **972274** **22⁹⁹**
 SAS866192 (M)
 SKU **972275** **22⁹⁹**
 SAS866193 (L)

- Form Fitting and Can Be Worn for Hours



10 Person First Aid Kit

SKU **000006** **22⁹⁹**
 SAS6010

- Multi-Use First Aid Kit Designed for Use in the Workplace for Up to 10 Employees



Foam Ear Plugs (Box of 200)

SKU **526953** **34⁹⁹**
 SAS6100

- Noise Reduction Rating: 30



NSX Turbo Safety Glasses (Box of 12)

- High Impact Clear Polycarbonate Lens
- 99.9% UV Protection
- Lightweight, Wrap Around Shade Lens

Clear Lens SKU **301767** | SAS5330PK **24⁹⁹**

Yellow Lens SKU **462984** | SAS5332PK **24⁹⁹**

Shade Lens SKU **462983** | SAS5331PK **24⁹⁹**



Camo LED Glasses

- Adjustable Ultra-Bright Built-In LED Lights
- High-Impact Polycarbonate Lens
- 99.9% UV Protection
- Anti-Fog & Scratch Resistant Lens Coating
- LR44 Batteries Included
- Meets ANSI Z87.1 - 2015

Green
 SKU **010115** **19⁹⁹**
 SAS5421



Tan
 SKU **010113** **19⁹⁹**
 SAS5422



NEW

Bottle Eye Wash Station*

SKU **094904** **49⁹⁹**
 SAS5132

- Includes (2) 16 Oz. Eye Irrigate Solution Bottles

Please Verify with OSHA or with a Certified Safety Professional That This Meets OSHA Requirements



16 Oz. Eye Wash Irrigate Refill

SKU **977588** **19⁹⁹**
 SAS5130

- For Use with Eye Wash Station SAS5132

16 Gallon Emergency Eye Wash Station

SKU **094905** **199⁹⁹**
 SAS5135

- Station Comes with Water Preservative
- One-Hand Operation Gravity-Fed 15 Minute Flow Time
- Change Water Every 90 Days



8 Oz. Eye Wash Preservative Refill

SKU **977586** **16⁹⁹**
 SAS5136

- For Use with Eye Wash Station SAS5135
- Portable Water Preservative
- Add One Bottle for Each 15 Gallons of Water

Back Belts

Deluxe Back Support Belt **19⁹⁹**

- Made of Lightweight, Cool, Washable Nylon
- Six Fully Enclosed Steel Springs Stay for Flexible, Contoured Support
- Tapered Design Allows a Full Range of Body Motion While Maintaining Proper Support



Small
 SKU **803153**
 SAS7161

Medium
 SKU **803156**
 SAS7162

Large
 SKU **803161**
 SAS7163

X-Large
 SKU **803151**
 SAS7164

XX-Large
 SKU **803152**
 SAS7165

Deluxe Hi-Vis Back Support **24⁹⁹**

- Bright Orange and Yellow Design Allows for Extra Visibility
- Made of Lightweight, Cool, Washable Polyester
- Tapered Design Promotes Better Movement for Proper Back Support



Small
 SKU **803154**
 SAS7261

Medium
 SKU **803157**
 SAS7262

Large
 SKU **803158**
 SAS7263

X-Large
 SKU **803159**
 SAS7264

XX-Large
 SKU **803160**
 SAS7265

SHOP SUPPLIES

10 Oz. OEMTOOL® Stainless Chuck
SKU 096882 26010

NEW

19⁹⁹ REG. \$24.99

- Made with Durable Kitchen-Grade 18/8 stainless Steel
- No Sweat Design Keeps Fingers Dry and Un-Frostbit
- Double-wall Vacuum Insulation Keeps Drinks Cold or Hot to the Last Sip
- BPA Free
- Keeps Ice 2x Longer Than Plastic Tumblers



SAVE \$5

20 Oz. OEMTOOL® Stainless Tumbler
SKU 096878 26009

NEW

19⁹⁹ REG. \$24.99

- Made with Durable Kitchen-Grade 18/8 stainless Steel
- No Sweat Design Keeps Fingers Dry and Un-Frostbit
- Double-wall Vacuum Insulation Keeps Drinks Cold or Hot to the Last Sip
- BPA Free
- Keeps Ice 2x Longer Than Plastic Tumblers



SAVE \$5

30 Oz. OEMTOOL® Stainless Tumbler
SKU 096881 26008

NEW

24⁹⁹ REG. \$29.99

- Made with Durable Kitchen-Grade 18/8 stainless Steel
- No Sweat Design Keeps Fingers Dry and Un-Frostbit
- Double-wall Vacuum Insulation Keeps Drinks Cold or Hot to the Last Sip
- BPA Free
- Keeps Ice 2x Longer Than Plastic Tumblers



SAVE \$5

3 Cup Box Set
SKU 096887 26014

OEM TOOLS

NEW

59⁹⁹ REG. \$69.99

- Includes: (1) 10 Oz. Stainless Colster, (1) 20 Oz. Stainless Tumbler, (1) 30 Oz. Stainless Tumbler, and Gift Box



SAVE \$10

Offers Good Thru September 30, 2016 - While Supplies Last

Shop Supplies

Work Ticket Holder (25/Box)

SKU 698887 44⁹⁹
SNGFBP993302

- Durable Brass Grommet Increases Strength
- Accommodates Most Pre-Printed and Computer Generated Forms
- Dimensions: 14.5" x 10.5"



SLIP GRIP

Paper Floor Mats

SKU 186484 49⁹⁹
SNGM0002PW226

- Coated Paper "Footprint" Style
- Box of 500
- 17" x 22"



SLIP GRIP

Value Coated Paper Floor Mats (500/Case)

SKU 262539 51⁹⁹
SNGM0758LX226

- 17" x 19" Plain Paper Mat
- Reusable
- Disposable
- Dispenses Off of Roll

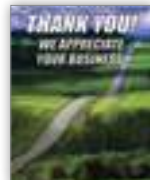

SLIP GRIP

White Plastic Key Tag Write On (1,000 Count)

SKU 262547 22⁹⁹
SNGMFBP993323

- Self Locking Plastic Key Tags Help Secure Keys
- Write On
- 1,000 Count



SLIP GRIP

Plastic Floor Mats

SKU 186488 59⁹⁹
SNGMFGP994302

- Slip-N-Grip Plastic Disposable Mat
- Box of 500 On a Roll 16.5" x 22"



SLIP GRIP

Adhesive Floor Mats (175/Roll)

SKU 262546 99⁹⁹
SNGMFBP993349

- Self Adhesive, 3 mL Protective Film
- Keeps Carpet Protected



SLIP GRIP

Steering Wheel Cover (500/Box)

SKU 186485 59⁹⁹
SNGMFBP994333

(250/Box)
SKU 262538 39⁹⁹
SNGMFBP994336



SLIP GRIP



Start-Up Kit (Dispenser and Product)

SKU 262544 379⁹⁹
SNGMFKP994376

- (250) Seat Covers, (500) Plastic Floor Mats, (500) Parts Bags, (250) Steering Wheel Covers, (100) Tire Bags and (250) Paper Floor Mats

SLIP GRIP



Disposable Value Seat Cover (500/Roll)

SKU 186487 69⁹⁹
SNGMFGP994315

(250/Roll)
SKU 262537 49⁹⁹
SNGMFGP994314

SLIP GRIP

Oil Change Labels

Thermal Oil Change Sticker Printer

SKU 526488 699⁹⁹
SNGFKGX00106

- Kit Includes: Printer, Keyboard, Power Cord/Adapter, (1) Ink Ribbon and (2) Rolls of 500 Generic Static Cling Labels

Static Cling Refill Kit

SKU 291380 119⁹⁹
SNGMFKG016501

- (2) Rolls of Labels
- (1) Replacement Ribbon



SLIP GRIP

Work Stands

Adjustable Tire Step

SKU 818571 34⁹⁹
24913

- Fits Both Front and Rear 9" to 13" Wide Tires
- Powder Coat Finish
- Designed for SUVs, Motor Homes and Light-Duty Trucks
- Heavily Textured Non-Slip Step for Safety
- Adjustable Rubber Bumpers Protect Your Wheels and Ensure the Tire Step Adjustable Easy to Adjust
- Weight Capacity: 300 Lbs.

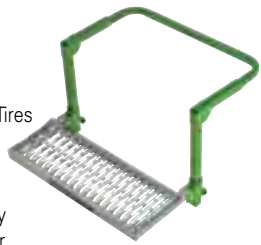

SHOP SUPPLY of the MONTH AUGUST
SEE INSERT FOR DETAILS

SAVE \$5

Pro Step Adjustable Work Stand

SKU 222856 164⁹⁹
STK20350

- 500 Lbs. Capacity
- 32" x 16"
- Height Adjustable from 6-1/2" to 22-1/2"



STECK

Trays

10" x 11" Magnetic Tray

SKU 965835 24⁹⁹
25119

- OEM Magnetic Trays Are Strong and Durable to Collect Small Parts, Fasteners and Tools
- Four Powerful Magnets with Protective Rubber Coating to Resist Scratching
- Ideal for Holding Small Parts and Tools
- Heavy Duty Stainless Steel



29" Portable Tear Down Tray

79⁹⁹

- Adjustable Table Height: 33.5 - 49.2"
- Weight Capacity: 55 Lbs.
- Work surface: 29.1 x 20.1"
- Easy to Maneuver with Four 2-1/2" Casters
- Durable Powder Coated Finish
- Color: Neon Green



Black
SKU 512947 24960

Green
SKU 850045 24616

OEM TOOLS

SAVE \$20

44" Aluminum Creeper

SKU 237641 79⁹⁹
71004 REG. \$99.99

- Lightweight and Strong Aluminum
- Adjustable Headrest

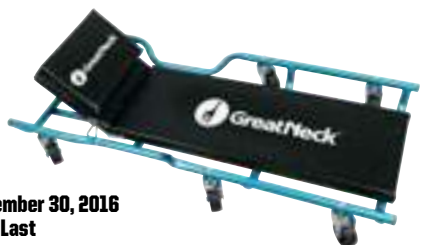

GreatNeck

Offer Good Through September 30, 2016 While Supplies Last

Shop Seats and Creepers

Z Creeper

SKU 964657 79⁹⁹
OMG91000

- From Creeper to Chair in One Motion
- Fully Upholstered Pad
- (6) 3" Polyurethane Wheels
- Powder Coat Finish
- 1 Year Warranty



OMEGA

Tractor Seat Creeper

SKU 301771 99⁹⁹
24953

- Tractor Style Shop Seat
- (4) Durable Swivel Casters
- Parts Tray



OEM TOOLS

Tool Box / Creeper Seat Combination

SKU 250704 84⁹⁹
OMG92450

- 450 Lbs. Rated Capacity
- Steel Frame Construction
- Extra Thick Seat Cushion
- 3 Drawer Locking Tool Box



Tools Not Included

OMEGA

Fender Covers

Fender Cover

SKU 818712 19⁹⁹
24902

- Heavy Gauge Vinyl Wipes Clean
- Sewn in Tool Ridge
- 27" x 34"
- Won't Mar or Scratch Surface
- Green in Color



OEM TOOLS

Fender Cover

SKU 965832 22⁹⁹
24900

- Heavy Gauge Vinyl Wipes Clean
- 27" x 34"



OEM TOOLS

Soft Fleece Fender Cover

SKU 751711 24⁹⁹
24899

- Large 42" x 24" Size for Cars, Trucks and SUVs
- Soft Fleece to Prevent Paint Damage and Strong Magnets to Hold Cover in Place



OEM TOOLS

Non-Slip Fender Cover

SKU 447120 24⁹⁹
80-205

- Heavy Gauge Vinyl Wipes Clean
- 24" x 36"



Duralast



Contact Us:
1-877-AZTool1 Phone
 (1-877-298-6651) *Hablamos Español*

Hardware Kits

34 Piece Hose Clamp Assortment
 SKU 271201 68137
13⁹⁹
 • Includes Sizes: 5/8" - 1-1/4"



96 Piece Mini Fuse Kit
 SKU 271169 68148
13⁹⁹
 • Includes: Mini Fuses 3A - 30A



96 Piece ATO Fuse Assortment
 SKU 271172 68149
13⁹⁹
 • Includes: ATO Fuses 3A - 30A



200 Piece Spring Assortment
 SKU 271195 68140
15⁹⁹
 • Includes: 7/32" x 11/16" - 5/16" x 1-1/4"



300 Piece E-Clip Assortment
 SKU 271188 68145
15⁹⁹
 • Includes: 1/16" - 7/8"



80 Piece Vacuum Cap Assortment
 SKU 271197 68129
15⁹⁹
 • Includes Sizes: 3/16" - 3/8"



555 Piece Cotter Pin Assortment
 SKU 271180 68120
18⁹⁹
 • Includes Popular Sizes: 1/16" x 1" - 5/32" x 2-1/2"



500 Piece Aluminum Rivet Assortment
 SKU 271150 68109
18⁹⁹
 • Includes: 1/8" and 3/16" Rivets 1/4", 5/16" and 3/8" Long



24 Piece Maxi Fuse Assortment
 SKU 271152 68146
18⁹⁹
 • Includes: Maxi Fuses 20A - 100A



158 Piece Wire Connector Assortment
 SKU 271200 68131
18⁹⁹
 • Popular Sizes for Joining 2, 3 or 4 Wires #22 - #10



240 Piece SAE Bolt, Nut and Washer Kit
 SKU 271179 68106
18⁹⁹
 • Includes Popular Sizes and Lengths: #8 - 3/8"



240 Piece Metric Bolt, Nut and Washer Kit
 SKU 271149 68107
18⁹⁹
 • Includes Popular Sizes and Lengths: M4 - M10



250 Piece Welding Stud Assortment
 SKU 271198 68130
18⁹⁹
 • 250 Piece 3/40" Size
 • Use with Stud Welder or Stud Gun
 • Copper Coated Steel Construction



270 Piece A/C O-Ring Kit
 SKU 271196 68141
21⁹⁹
 • Contains 270 O-Rings in a Variety of SAE Sizes
 • Great O-Ring Set for Most Automotive and Refrigerant Applications



88 Piece Master Auto Fuse Assortment
 SKU 271161 68147
23⁹⁹
 • Includes: Popular Sizes of Mini, ATO and Maxi Fuses 3A - 100A



110 Piece Metric Copper Washer Assortment
 SKU 271176 68117
28⁹⁹
 • Includes Popular Sizes: M6 - M16



555 Piece Stainless Cotter Pin Assortment
 SKU 271183 68121
38⁹⁹
 • Includes Popular Sizes: 3.2 mm x 50 mm - 8 x 64 mm



407 Piece Universal O-Ring Set (SAE)
 SKU 546661 68168
19⁹⁹
 • (34) Popular Sizes
 • Inside Diameters from 1/8" to 2"
 • Complete with Secure Fit Latched Storage Case, Keeps Each Size Separate and Easy to Identify



419 Piece Universal O-Ring Set (Metric)
 SKU 546659 68167
19⁹⁹
 • Pliable, Flexible Rubber Rings Seal Contact and Connection Points Like Mini Gaskets
 • Inside Diameters from 3 mm to 50 mm



Heat-Shrink Tube Sets

171 Piece Heat-Shrink Tube Set
 SKU 420335 68165
19⁹⁹
 • Protection and Insulation of Components and Wires
 • Protection Against Water and Moisture Ingress Preventing Corrosion
 • Color Coordinated Sizes
 • Quick and Simple to Shrink By Heat Gun



106 Piece Waterproof Heat-Shrink Tube Set
 SKU 420334 68164
29⁹⁹
 • Tubes Shrink to Fit Over Cable Splices and Can Be Used for Wire Harnessing, Covering, Marking and Bundling of Wires
 • Adhesive Lined Inner Wall to Seal Out Moisture
 • 3:1 Shrink Ratio
 • Waterproof



REPAIR IT RIGHT

90 Piece Waterproof Heat-Shrink Terminal Set
 SKU 462482 68166
79⁹⁹
 • (30) Ring Connectors
 • (15) Butt Connectors
 • (15) Tin Butt Connectors
 • (15) Female Disconnects
 • (15) Male Disconnects
 • Re-Sealable Plastic Case



Hand Cleaner

Starter Kit with BONUS Dispenser
 SKU 972773 24292
34⁹⁹
 • Kit Includes Wall-Mount Dispenser and 4,000 mL of Cherry Fragrance Cleaner

4000 mL Refill Bottle
 SKU 972772 24291
34⁹⁹

World's Best Hand Cleaner

- All Natural, Concentrated, Solvent Free Cleansing Formula
- Unique Skin Conditioning System Leaves Hands Feeling Smoother, While Fibril Scrubbers Deep Clean Even the Toughest Dirt
- Cherry Fragrance Leaves Hands Smelling Great
- 100% Biodegradable

Cherry Fragrance Leaves Hands Smelling Great

Cleans the Toughest Dirt...SO GET DIRTY!

OEM TOOLS



Shop Stool

Adjustable Hydraulic Shop Stool
 SKU 751712 24912
79⁹⁹
 • Adjustable Hydraulic Stool
 • Raises from 28" to 32.5"
 • Vinyl-Padded Swivel Seat for Comfortable Support
 • Chrome Foot Rests Won't Wear Out



BUY TWO STOOLS FOR \$79.99
SAVE \$19.99



Two Swivel Shop Stools
 SKU 432326 24910TWO
79⁹⁹
 • Swivel Seat
 • Double Foot Ring for Strength
 • Seamless Pad
 • 30.5" High x 14" Across

One Swivel Shop Stool
 SKU 512951 24910
49⁹⁹

OEM TOOLS

BUY TWO STOOLS FOR \$159.99

SAVE \$39.99



Two Adjustable Hydraulic Stools
 SKU 362969 24911TWO
159⁹⁹
 • Swivel Seat
 • Double Foot Ring for Strength
 • Cushioned Pad
 • Raise from 28" to 32-1/2"

One Adjustable Hydraulic Stool
 SKU 512945 24911
99⁹⁹

Offer Good Through September 30, 2016 - While Supplies Last

OEM TOOLS

Replacement Stool Seat

Replacement Garage Stool Cushion-Checkered
 SKU 802205 OTE801005P
19⁹⁹
 • Replacement Cushion for 30.5" x 14" Garage Counter Stool
 • Black and White Checkered Pattern
 • Cushion Seat Only



Recovery Tow Ropes

Kinetic Recovery Tow Ropes
 • 45% Stronger and Lighter Than Wire Rope
 • Does Not Curl, Kink or Pinch Itself
 • Safer Than Wire Rope If the Line Breaks Due to Overloading
 • 6" Eyes Have Protective Sleeve to Reduce Wear and Tear
 • 2-to-3 Times Stronger Than Nylon Straps with Eyes
 • Includes Protective Storage Bag



1/2" x 20' SKU 751611 | MIB448501 **59⁹⁹**
 • 7,300 Lbs. Capacity
3/4" x 20' SKU 751610 | MIB448511 **99⁹⁹**
 • 16,000 Lbs. Capacity
7/8" x 20' SKU 751612 | MIB448521 **139⁹⁹**
 • 24,700 Lbs. Capacity
7/8" x 30' SKU 751619 | MIB448531 **174⁹⁹**
 • 24,700 Lbs. Capacity
1-1/4" x 30' SKU 751620 | MIB448541 **289⁹⁹**
 • 44,200 Lbs. Capacity
1-1/2" x 30' SKU 751613 | MIB448551 **399⁹⁹**
 • 64,300 Lbs. Capacity

BUY TWO STOOLS FOR \$79.99 **SAVE \$19.99**

Garage Counter Stools

- 30.5" High x 14" Across
- Seamless, Thick Foam, Non-Swivel Seat
- Single Foot Ring
- Non-Skid Foot Pads

TWO STOOL SPECIAL Single Stool
79⁹⁹ 49⁹⁹

Offer Good Through September 30, 2016 - While Supplies Last

Chevrolet®
 SKU 387632 OTE809005TWO
 SKU 980166 OTE809005 (ea.)



SKU 387635 OTE801005TWO
 SKU 980163 OTE801005 (ea.)



SHOP SUPPLIES

BLAZER

NEW COMMERCIAL BULB CABINET PROGRAM



BASE PLAN (120 BULBS) - SKU# 773436

SubPart #	SKU#	Quantity	SubPart #	SKU#	Quantity
L79006BX	292559	3 boxes of 1	L70004BX	292557	2 boxes of 1
L7H1150W8X	292558	2 boxes of 1	L71940X	292504	2 boxes of 10
L7H730W8X	292561	3 boxes of 1	L731578X	292542	2 boxes of 10
L79007BX	292560	3 boxes of 1	L711578X	292521	2 boxes of 10
L79008BX	292556	3 boxes of 1	L730578X	292537	1 box of 10
L79009BX	292558	2 boxes of 1	L74438X	292552	1 box of 10
L7H155W8X	292587	2 boxes of 1	L71888X	292502	2 boxes of 10

For additional replacement bulbs contact your AutoZone sales representative today

\$169.99

AutoZone has bulb plans designed to make sure you have all the bulbs you need on hand

LED Safety Glasses

- Polycarbonate Frame and Lenses
- Light Output: 32 Lumens
- (4) CR1632 Batteries



Vindicator
SKU 555987
LSSG-279760 **19⁹⁹**

- Black Glossy Finish



Predator
SKU 514090
LSSG-280377 **19⁹⁹**

- Camo Glossy Finish

Do you want to help customers see better and drive safer?

SYLVANIA Automotive Lighting has options for an improved driving experience

SYLVANIA zXe®

HID Attitude // Xenon Fueled

- The perfect balance of performance and style.
- Cobalt blue nano coating technology to deliver our **whitest halogen***
- Mirror Top alloy coating
- 100% street legal and DOT approved



SYLVANIA SilverStar® ULTRA

Brightest Downroad and Whiter Light*

- Whiter color*
- Most downroad*
- More clarity*
- For ULTRA night vision
- Does not increase glare



SYLVANIA SilverStar®

Brighter Downroad and Whiter Light*

- Whiter color*
- More downroad*
- More clarity*
- Does not increase glare



SYLVANIA XtraVision®

Brighter Downroad*

- More downroad*
- Does not increase glare



HID Portfolio

SYLVANIA Xenarc HID

- Actual OEM product ensures quality, precision, and consistent performance
- Complies with SAE regulations which require 80% brightness in 4 seconds
- Superior Quality from America's #1 Automotive Lighting Manufacturer

Family	BASIC
D1R	✓
D1S	✓
D2R	✓
D2S	✓
D3R	✓
D4R	✓
D4S	✓
D8S	✓



Miniature Replacement Bulbs

SYLVANIA LEDs

- Direct Replacement for incandescent bulbs
- 77 bulbs covering 94% applications

SYLVANIA ZEVO®

- ZEVO LIFETIME WARRANTY
- Superior quality
- Longer Life than incandescent bulbs
- Low power consumption



SYLVANIA LED

- Longer Life than incandescent bulbs
- Low power consumption



Traditional Incandescent

- Direct Replacement for OE miniature bulbs

SYLVANIA SilverStar®

- Whiter color*
- Improves contrast and clarity



SYLVANIA LongLife

- Longer Life than Basic bulbs
- 99% Vehicle application coverage



Available Single and Twin Packs in Sylvania Capsules

PART	BASIC	XV	ST	ULT	ZXE
9006	SN/TW	SN/TW	SN/TW	SN/TW	TW
H11	SN/TW	SN/TW	SN/TW	SN/TW	TW
9007	SN/TW	SN/TW	SN/TW	SN/TW	TW
H7	SN/TW	SN/TW	SN/TW	SN/TW	TW
9003	SN/TW	SN/TW	SN/TW	SN/TW	TW
9005	SN	SN/TW	SN/TW	SN/TW	TW
H1-55W	SN	SN	SN	SN/TW	TW
H13	SN	SN/TW	SN/TW	SN/TW	TW
9004	SN/TW	SN/TW	SN/TW	SN/TW	TW
9145	SN		SN		TW
H3-55W	SN		SN		TW
9006XS	SN		SN		TW
880	SN		SN		TW
881	SN				TW
9005XS	SN		SN		TW
893	SN		SN		

Only Offered in BASIC Single: H11B, H9, 9012, H8, 899, 9140, H3-100W, 5202, 898, 896, 894, 886, 2504, 885, 889, 9011, 5201, 891, 9040, H16, H15

SN = Single TW = Twin

Contact Your Commercial Sales Manager for Details

SYLVANIA

*Compared to only SYLVANIA BASIC



Contact Us:
1-877-AZTool1 Phone
 (1-877-298-6651) *Hablamos Español*

AutoZone
Tool & Equipment QUARTERLY

NEW Tools of the Trade



ALLDATA TECH-ASSIST

ALLDATA MOBILE

Industry-leading OEM repair information – right at your fingertips

MOBILE

No more back and forth between the vehicle and the computer station. Get all the OEM repair data you need with a subscription to ALLDATA Repair® and Mobile. With our mobile app you can read/clear P-Codes, view live sensors, pre-check emissions, and more with an OBDII connector and tablet.

Ask about our tablet bundles!



TECH-ASSIST

ALLDATA Tech-Assist is staffed by a highly-skilled diagnostic team of ASE Certified Master Technicians. Whatever you need – from creating alternative diagnostic strategies to providing step-by-step repair assistance – we can deliver! It's like having a Master Technician in your shop that isn't on your payroll.

©2016 ALLDATA LLC. All rights reserved. ALLDATA, ALLDATA Repair, ALLDATA Mobile and ALLDATA Tech-Assist are registered trademarks of ALLDATA LLC. AutoZone and AutoZone & Design are registered trademarks of AutoZone Parts, Inc. ASE Certified is a trademark of the National Institute for Automotive Service Excellence (ASE). All other marks are the property of their respective holders.

For More Information
(888) 726-3211

ALLDATA
 An AutoZone® Company



Got Questions?

Call AutoZone®
Tool & Equipment
Customer Service:

1-877-AZTool1 (phone)
(1-877-298-6651)
HABLAMOS ESPAÑOL

July, August and September 2016

Call Center Hours of Operation:
7:00AM to 5:00PM Central Standard Time

Tumblers

Offers Good Thru September 30, 2016 - While Supplies Last

OEMTOOLS Tumblers®

- Made with Durable Kitchen-Grade 18/8 Stainless Steel
- No Sweat Design Keeps Fingers Dry and Un-Frostbit
- Double-wall Vacuum Insulation Keeps Drinks Cold or Hot to the Last Sip
- BPA Free
- Keeps Ice 2x Longer Than Plastic Tumblers



10 Oz.
SKU 096882
Part# 26010
19⁹⁹
REG. \$24.99

SAVE \$5



20 Oz.
SKU 096878
Part# 26009
19⁹⁹
REG. \$24.99

SAVE \$5



30 Oz.
SKU 096881
Part# 26008
24⁹⁹
REG. \$29.99

SAVE \$5



3 Piece Gift Set!

3 Cup Box Set
SKU 096887
Part# 26014
59⁹⁹
REG. \$69.99

SAVE \$10

OEM TOOLS

NEW

SAVE \$20

6" Heavy Duty Bench Vise with Swivel Base

SKU 751654
24218
79⁹⁹
REG. \$99.99

- Machined Replaceable Steel Jaws
- Machined Anvil, Permanent Pipe Jaws
- Full 360° Swivel Base
- Clamping Strength: 300 Lbs.



OEM TOOLS

Offer Good Through September 30, 2016 - While Supplies Last

Rechargeable Lights



200 Lumen Rechargeable Multi-Use Work Light

SKU 105545
24603
39⁹⁹

- Performs Like a Corded, Without the Restrictions
- 200 Lumens of Super Bright Light Lasts Up to 3 Hrs.
- Holds Charge for a Longer Runtime with 2500 mAh Li-Ion Battery
- Nearly 7 Inches in Length Easily Lights Large and Dark Areas
- Universal Micro USB Charger Lets You Charge Anywhere
- Incredibly Portable at Only 5 Oz.
- Strong Magnets On Each End



330 Lumen Rechargeable Multi-Use Work Light

SKU 105560
24605
49⁹⁹

- Performs Like a Corded, Without the Restrictions
- 330 Lumens of Super Bright Light Lasts Up to 3 Hrs.
- Holds Charge for a Longer Runtime with 4400 mAh Li-Ion Battery
- Nearly 9 Inches in Length Easily Lights Large and Dark Areas
- Universal Micro USB Charger Lets You Charge Anywhere
- Incredibly Portable at Only 7.3 Oz.
- Strong Magnets On Each End

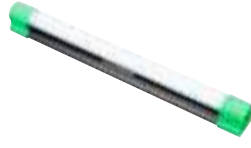

600 Lumen Rechargeable Multi-Use Work Light

SKU 822266
25997
69⁹⁹

- Performs Like a Corded Light, Without the Restrictions
- 600 Lumens of Super Bright Light Lasts Up to 6 Hrs.
- 8800 mAh Li-Ion Technology Holds Charge for 6 Months without Charging
- Incredibly Portable at 13.4" and Only 12 Oz.
- Includes Universal USB Charger Allowing You To Charge Anywhere
- Strong Magnetic Back Attaches to Any Ferrous Metal Surface
- Runtime: 100% (6 Hrs.), 50% (10 Hrs.) and 10% (54 Hrs.)



Large 1000 Lumen Rechargeable Multi-Use Work Light

SKU 850288
24604
199⁹⁹

- Performs Like a Corded, Without the Restrictions
- 1000 Lumens of Super Bright Light Lasts Up to 9 Hrs.
- Holds Charge for a Longer Runtime with 17600 mAh Li-Ion Battery
- Nearly 2 Ft. in Length Easily Lights Large and Dark Areas
- Universal Micro USB Charger Lets You Charge Anywhere
- Incredibly Portable at Only 22 Oz.
- Strong Magnets On Each End

OEM TOOLS

SAVE \$10

1/4" Mini Angle Die Grinder and Surface Prep Kit

SKU 094648
25777
49⁹⁹
REG. \$59.99

- Right Angle Design for Tight Places
- Weights Only 1.1 Lbs.
- Grinding and Cleaning All-in-One Kit
- 20,000 RPM for Clean Precise Work
- 4 CFM Air Usage Works with Small Compressors
- Adjustable Air Throttle for Control to Fit the Job
- Air Inlet Strainer
- Angle Head Grease Fitting
- Includes: (10) Grinding Stones in 1/4" and 1/8" Shank Sizes; 1/4" and 1/8" Collet; (4) 2" and (4) 3" Cleaning Discs Stripping; 2" and 3" Backing Pads; 2 Piece Hand Wrench and 2 Piece Disc Holder (1/4")



OEM TOOLS

Offer Good Through September 30, 2016 - While Supplies Last

Recovery Machines



Fully Automatic R134a Recovery, Recycle, Recharge Station

SKU 300780
MSC69789
3,399⁹⁹

- Automatic, Programmable with Manual Modes
- Compressor: Hermetically Sealed, 12 cc
- Vacuum Pump: 6 CFM, 100 Liter/Min. Capacity
- Bottle Temperature Sensor: Integrated
- Includes Upgradeable Refrigerant Capacity Database
- 1 Year Warranty

MAHLE



ACX1120H R134a A/C Refrigerant Handling System

SKU 850570
MSSACX1120H
2,799⁹⁹

- ECO LOCK® Quick Couplers
- Designed for Servicing all Passenger Cars, Trucks and Hybrid Vehicles
- High Performance Vacuum Pump to Ensure Faster Service Times
- Fully Automatic
- 2 Year Warranty

CPS



R134a Refrigerant/Recover/Recharge Machine with Printer

SKU 695135
CPSFX134A
3,999⁹⁹

- On Board Vehicle A/C Data: 1994-2015
- 10 Ft. Charging Hoses
- 6 CFM Vacuum Pump
- Heater Blanket Included
- 1-2-5 Warranty

Hybrid Ready

SAVE \$20

12V Li-Ion Cordless Combo Kit

SKU 847089
MAKCT226
179⁹⁹
REG. \$199.99

- 3/8" Driver Drill with 210 Lbs. of Max Torque
- 1/4" Impact Driver with 970 Lbs. of Max Torque
- Includes 2-12V Slide Batteries
- Batteries Charge in 25 Minutes
- Built-in LED Light



Makita

Offer Good Through September 30, 2016 - While Supplies Last

Lease to Own Equipment

Financing is provided by third parties who are not affiliates of AutoZone. All of the advertised loan programs, rates, terms and conditions are subject to change at any time without notice. An extra charge may be imposed at the end of the lease depending on the residual value of the leased goods.

©2016 AutoZone, Inc. All rights reserved. AutoZone, AutoZone & Design, Loan A Tool, Duralast, Duralast Gold and Duralast ProPower are registered marks of AutoZone LLC or one of its affiliates. Items requiring freight shipping cannot be delivered outside of the continental United States. For shipping cost to Alaska, please contact Commercial Sales Manager. All other marks are the property of their respective holders. Ad prices cannot be combined with any other offer. Offers may vary by market. Offers valid while quantities last. We reserve the right to limit quantities and to correct pricing errors. Some new items might not be available at the time of print deadline. Prices valid only during sales catalog effective dates. All photographic, clerical, typographical and printing errors are subject to correction. Images shown may not be actual product but represents products or sets which include product. We reserve the right to substitute a like item or an item of greater value on any promotional offer in this publication. Items may not be available at all locations at all times. Store stock items may be purchased at any local AutoZone store or through your AutoZone Commercial Sales Manager. iPhone® is a registered trademark of Apple Inc., Android® is a trademark of Google Inc., and Bluetooth® is a trademark of Bluetooth® SIG, Inc.



Be Car Care Aware

AZG0316 | SKU 995478 \$2.99



**AIR
TOOL
of the
MONTH**

AutoZone
1-877-AZTool1

**TOOL
of the
MONTH**

AutoZone
1-877-AZTool1

**SAVE \$20 PLUS BONUS
VALUE UP TO 49⁹⁹**

Offer Good July 1 - 31, 2016
While Supplies Last

OEM TOOLS

**AIR
TOOL
of the
MONTH**

**JULY Super Duty Mini Composite
Air Impact Ratchets**

1/4" Drive
SKU 850508
24415

BONUS

12 Piece 1/4"
Metric Deep Socket Set
in EVA Tray
SKU 850510 | Part# 23986
VALUE: \$44.99

with Purchase of:
Super Duty
Mini Composite 1/4" Drive
Air Impact Ratchet
SKU 850508 | Part# 24415



**700
RPM**

**BEST POWER TO RATE
RATIO IN IT'S CLASS**

Impact Mechanism Adds Power and Prevents Kickback



3/8" Drive
SKU 850055
24416

159⁹⁹ EA.
REG. \$179.99 EA.

SAVE \$20

BONUS

12 Piece 3/8"
Metric Deep Socket
Set in EVA Tray
SKU 103402 | Part# 23981
VALUE: \$49.99

with Purchase of:
Super Duty
Mini Composite 3/8" Drive
Air Impact Ratchet
SKU 850055 | Part# 24416



SAVE \$20

Offer Good July 1 - 31, 2016
While Supplies Last

OEM TOOLS

**TOOL
of the
MONTH**

JULY 7 Piece Locking Plier Set

NEW

SKU 012622
23987

99⁹⁹
REG. \$119.99

- Sizes: 4", 5", 7", 10" Curved Jaw and 4", 6", 9" Long Nose
- Hex Key Adjusting Screw Tightens to Adjust Pressure



UNIQUE HEX GRIP
Outer 10 mm Hex Screw With
Inner #2 Phillips Screw For More
Tightening and Release Pressure

EVA TRAYS
Features a Hard Top
Carbon Fiber Style
Finish that Makes for a
Life Long Lasting Tray.



SAVE \$30

Offer Good August 1 - 31, 2016
While Supplies Last

OEM TOOLS

**AIR
TOOL
of the
MONTH**

**AUGUST Heavy Duty Mini
Surface Prep Kit**

- Includes:
- 2" and 3" Heavy Duty Mini Air Surface Prep Sander
 - (1) 2" Backer Pad and (1) 3" Backer Pad
 - (2) 2" and (2) 3" Medium Grit Surface Prep Discs
 - (2) 2" and (2) 3" Coarse Surface Prep Discs
 - (2) 2" and (2) 3" Sanding Discs
 - Air Nipple

SKU 087620
24417

119⁹⁹
REG. \$149.99

NEW



SAVE \$32

Offer Good August 1 - 31, 2016
While Supplies Last

OEM TOOLS

**TOOL
of the
MONTH**

**AUGUST 1/4" 82 Piece Ratchet
and Socket Set**

NEW

SKU 087605
23982

- This Set Includes a Variety of The Most Popular 1/4" Size Sockets, Wrenches, Screwdrivers and More
- Comes With a Ratcheting Screwdriver With 45 Tooth Mechanism and 3 Locking Positions for Smoother Strokes
- Sockets Are Thin Walled With Chamfered Ends and a POSI-GRIP® NO-SLIP Design Providing More Socket-to-fastener Contact

- Comes in Secure Blow Molded Case for Easy Organization and Transporting
- (10) 1/4" Drive 6 Point SAE Sockets, Sizes 3/16"-9/16"
- (12) 1/4" Drive 6 Point Metric Sockets, Sizes 5mm-15mm
- (10) 1/4" Deep Drive 6 Point SAE Sockets, Sizes 3/16"-9/16"
- (12) 1/4" Deep Drive 6 Point Metric Sockets, Sizes 5mm-15mm
- Ratchet
- 32 Piece Bit Set

127⁹⁹
REG. \$159.99



SAVE \$30

Offer Good September 1 - 30, 2016
While Supplies Last

OEM TOOLS

**AIR
TOOL
of the
MONTH**

**SEPTEMBER Heavy Duty 1/2" Drive
Composite Stubby Air
Impact Wrench Set**

- 1/2" Square Composite Air Impact Delivering 900 Lbs. of Torque
- Includes (7) 1/2" Drive Short Impact Socket Sizes 13mm -19mm
- Comes in EVA Tray

SKU 087596
24418

169⁹⁹
REG. \$199.99

NEW



SAVE \$15

Offer Good September 1 - 30, 2016
While Supplies Last

OEM TOOLS

**TOOL
of the
MONTH**

**SEPTEMBER 42 Piece 3/8"
Impact Socket Set**

NEW

SKU 087600
23983

- (8) 3/8" Drive 6 Point SAE Sockets, Sizes 5/16"-3/4"
- (12) 3/8" Drive 6 Point Metric Sockets, Sizes 8mm -19mm
- (8) 3/8" Drive Deep 6 Point SAE Sockets, Sizes 5/16"-3/4"
- (12) 3/8" Drive Deep 6 Point Metric Sockets, Sizes 8mm -19mm
- 3/8" Drive 3" Extension
- 3/8" Drive Universal Joint

109⁹⁹
REG. \$124.99



EVA TRAYS
Features a Hard Top
Carbon Fiber Style
Finish that Makes for a
Life Long Lasting Tray.



Items must be on the same invoice to qualify for pricing. Not valid with any other offer. Offer valid while supplies last. Offer good for AutoZone Commercial customers only. No rain checks. Discounts are subject to change without notice. We reserve the right to limit quantities. Allow 1-2 weeks for delivery. Ask your Commercial Sales Manager for details. ©2016 AutoZone, Inc. All rights reserved. AutoZone, AutoZone and Design, Loan A Tool, Duralast, Duralast Gold and Duralast ProPower are registered marks of AutoZone Inc. LLC or one of it's affiliates. All other marks are the property of their respective owners.

Items must be on the same invoice to qualify for pricing. Not valid with any other offer. Offer valid while supplies last. Offer good for AutoZone Commercial customers only. No rain checks. Discounts are subject to change without notice. We reserve the right to limit quantities. Allow 1-2 weeks for delivery. Ask your Commercial Sales Manager for details. ©2016 AutoZone, Inc. All rights reserved. AutoZone, AutoZone and Design, Loan A Tool, Duralast, Duralast Gold and Duralast ProPower are registered marks of AutoZone Inc. LLC or one of it's affiliates. All other marks are the property of their respective owners.

**DIAGNOSTIC
TOOL of the
MONTH**

AutoZone
1-877-AZTool1

**SHOP
SUPPLY
of the
MONTH**

AutoZone
1-877-AZTool1

SAVE \$10

Offer Good July 1 - 31, 2016
While Supplies Last



**DIAGNOSTIC
TOOL
of the
MONTH**

JULY AutoLink® OBDII/CAN Code
Reader with Color Screen

Reads Live Data

SKU 222492
AULAL319

- Bright Color Coded LEDs and Built-in Speaker
- Retrieves Generic, Manufacturer Specific and Pending Codes
- Determines the Cause of the Malfunction Indicator Light
- Turns Off Malfunction Indicator Light, Clears Codes and Resets Monitors

- Displays OTC Definitions on the TFT Color Screen
- Views Freeze Frame Data
- Displays Monitor and I/M Readiness Status



49⁹⁹
REG. \$59.99

**SHOP
SUPPLY
of the
MONTH** **JULY**



SAVE \$5 EACH

- Made with Durable Kitchen-Grade 18/8 Stainless Steel
- No Sweat Design Keeps Fingers Dry
- Double-wall Vacuum Insulation Keeps Drinks Cold or Hot to the Last Sip
- BPA Free
- Keeps Ice 2x Longer Than Plastic Tumblers

**30 oz.
Stainless
Jackhammer**

SKU 096881
26008

24⁹⁹
REG. \$29.99



**20 oz.
Stainless
Hammer**

SKU 096878
26009

19⁹⁹
REG. \$24.99



**10 oz.
Stainless
Chuck**

SKU 096882
26010

19⁹⁹
REG. \$24.99

NEW

Tumbler Box Set

SKU 096887
26014

59⁹⁹
REG. \$69.99



- One Each:
30 Oz.
20 Oz.
10 Oz.

BONUS VALUE \$279⁹⁹

Offer Good August 1 - 31, 2016
While Supplies Last



**DIAGNOSTIC
TOOL
of the
MONTH**

AUGUST MaxiSYS® MS906

NEW

1,499⁹⁹

SKU 040101
AULMS906

- Features Tethered Cable OBDII Connector
- Covers US/Asian/European Vehicles
- Instantly Retrieves Vehicles Info
- OE-Level Vehicle Coverage and Functions
- Detect and Display Faults and Trouble Codes
- Live Data View/Print/Store/Playback
- Dedicated Services Section- Oil Service Reset, TPMS Relearn, EPB, ABS/SRS, SAS
- Full-Screen Waveform Graphing Analysis with Trigger-Type Recording Modes



BONUS

MaxiTPMS® TS401
Diagnostic and
Service Tool

SKU 255740 | Part# AULTS401

VALUE: \$279.99



with Purchase of:
MaxiSYS® MS906

SKU 040101 | Part# AULMS906



Comparable to the MS905K but at a Lower Price

**SHOP
SUPPLY
of the
MONTH** **AUGUST**



SAVE \$5

Offer Good August 1 - 31, 2016 While Supplies Last

Adjustable Tire Step

SKU 818571
24913

- Fits Both Front and Rear 9 In. to 13 In. Wide Tires
- Powder Coat Finish
- Designed for SUVs, Motor Homes and Light-Duty Trucks
- Heavily Textured Non-Slip Step for Safety

This Tire Step is Designed for SUVs, Motor Homes and Light-Duty Trucks, Making it Perfect for Accessing Roof Racks, Windshields, Under Hood and More.

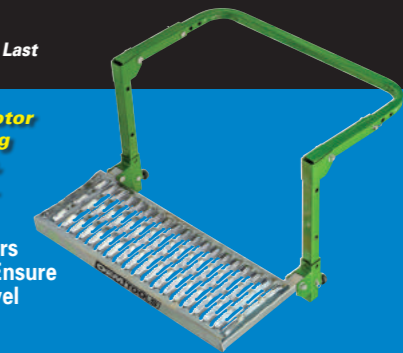

29⁹⁹
REG. \$34.99

BONUS VALUE \$124⁹⁹

Offer Good September 1 - 30, 2016
While Supplies Last



**DIAGNOSTIC
TOOL
of the
MONTH**

SEPTEMBER MaxiSYS®
Diagnostic Scan
Tool System

2,699⁹⁹

SKU 464052
AULMS908

- Powerful Cortex-A9 Quad-Core Processor
- 9.7" 1.02 x 768 LED-backlit Glossy Multi-Touch Display with IPS Technology
- Internal Reliable 32GB SSD for Better Performance and Storage
- Built-In 5 f/Megapixel Rear Camera with Autofocus and Flashlight
- Dual-band (2.4 GHz and 5.0 GHz) 802.11n Wi-Fi Automatically Updates Software

- Ergonomic Design Features Strong Rubber Protection and Housing
- Built-In Rechargeable Li-Ion Battery for Up to 8 Hours of Operation



BONUS

AutoLink® Enhanced
OBDII Scan Tool!

SKU 222483 | Part# AULAL519

VALUE: \$124.99



with Purchase of:
**MaxiSYS® Diagnostic
Scan Tool System**

SKU 464052 | Part# AULMS908

**SHOP
SUPPLY
of the
MONTH** **SEPTEMBER**



SAVE \$5

Offer Good September 1 - 30, 2016 While Supplies Last

Digital Tire Inflator

SKU 802198
24412

- Easy-to-Read Backlit LCD Display
- Four Units of Measure (PSI, Bar, KPa, kgf)
- Measuring Range: 0 - 12 Bar (0 - 175 PSI)
- Accuracy: +/-1.2 PSI Up to 58 PSI, +/-2.3 Between 58 PSI and 145 PSI Inclusive, +/-3.6 PSI Greater Than 145 PSI
- High Air Flow Saves the Technician Time



54⁹⁹
REG. \$59.99