

AUTOMOTIVE LIFTS

2 Post Lifts

Challenger E10 10,000 Lbs. 2 Post Lift

SKU 435061
CHLLE10 **2,799⁹⁹**

- 3-Stage Front Arms and 2-Stage Rear Arms for Asymmetric or Symmetric Lifting in the Same Service Bay, Uni-Body Design Vehicles, Vehicles with Designated Outside Lift Points, Wider Vehicles, Low Profile Vehicles and Both Short and Long Wheelbases
- Double Telescoping Screw Pads with Rubber Foot Pads
- Rubber Door Guards Protect Vehicle From Door Damage
- 11' 11-7/8" Standard Height Fits in Service Bay with 12' Ceiling Height

Price Does Not Include Vehicles, Installation or Optional Equipment as Shown



NEW

10,000 Lbs. 2 Post Lift

SKU 499657
FOR110 **2,799⁹⁹**

- Low Profile 3-5/8" Min. Adapter Height
- Spot-Rite™ 3 Stage Front Arms for Symmetric and Asymmetric Lifting
- Overall Height: 143-3/8"
- Overall Floor Width: 137"
- Maximum Lifting Height: 76"
- Inside Column Width: 115"
- Drive-Thru Clearance: 105"
- Minimum Ceiling Height: 144"

(Truck Adapters Included)

Price Does Not Include Vehicles, Installation or Optional Equipment as Shown



NEW LOWER PRICE

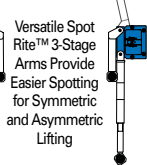

Brigadier D-10 ACX

SKU 186433
DAN1375647 **2,499⁹⁹**

- Lifting Capacity: 10,000 Lbs./4,546 Kg
- Overall Height: 145" / 3,683 mm
- Overall Width (Outside of Base Plates): 143-1/2"
- Width Between Columns: 112-3/4"
- Rise: 69" / 1,753 mm
- Maximum Lifting Height (Pad and 6" Adapter): 79" / 2,007 mm
- Drive-Thru Clearance: 100-1/2"
- Motor: 220 VAC 60Hz. 1Ph

(Truck Adapters Included)

Dannmar EQUIPMENT

Price Does Not Include Vehicles, Installation or Optional Equipment as Shown



10,000 Lbs. Dual Width Clearfloor 2 Post Lift, Screw Pad

- Expandable Top Beam Accommodates Wide or Narrow Drive-Thru Configuration
- Double Telescoping Screw Pads Offer Increased Versatility
- Height Overall: 145"

Symmetric
SKU 296968
BENXPR-10S
3,149⁹⁹

- Inside Columns: 105.5" - 118.5"

Asymmetric
SKU 297001
BENXPR-10AS
3,199⁹⁹

- Inside Columns: 104" - 112"

Symmetric Low-Pro Arms
SKU 296983
BENXPR-10S-LP
3,199⁹⁹

- Inside Columns: 105.5" - 118.5"

Asymmetric Low-Pro Arms
SKU 297003
BENXPR-10ASLP
3,199⁹⁹

- Inside Columns: 104" - 112"



Price Does Not Include Vehicles, Installation or Optional Equipment as Shown

(Truck Adapters Included)

5-2-1 Warranty

Five Years (60 Months) Warranty on the lift structure
Two Years (24 Months) Warranty on the hydraulic cylinder(s) and power unit
One Year (12 Months) Warranty on operating components
One Year (12 Months) Labor Warranty on site or at factory
One Year (12 Months) Free-Shipping* on ground-freight charges related to warranty performance
*Free-shipping applies to direct shipping points within the 48 continental United States. Rural area shipping surcharge may apply for remote addresses. See BendPak.com for specific terms of warranty.

10,000 Lbs. F10 2 Post Lift

SKU 818779
FORF1000MBL **2,599⁹⁹**

- Low Profile/Oversized Pads to Raise Most Vehicles
- 3 Stage Front Arms for Symmetric and Asymmetric Lifting
- Includes (4) 3.5" and 5" Adapter Extenders
- Warranty: 60 Days Labor, 18 Months Parts, 5 Years Structural

10,000 Lbs. 2 Post Lifts

SKU 534581
ROTSP0A10
4,149⁹⁹

Asymmetrical

- Surface Mounted, Frame Contact Lift
- Features Electric Hydraulic Operation and Genuine Symmetrical Design for Overhead Design for Clear Floor Lift
- Factory Rotated Columns Allow Doors of Vehicle to Be Fully Opened While Properly Positioned on Lift
- Arm Restraints on All Arms

SKU 210371
ROTSP010
4,149⁹⁹

Symmetrical

We Carry the Full Line of Rotary Lifts!
Call 1-877-AZTool1 for Details.

Price Does Not Include Vehicles, Installation or Optional Equipment as Shown

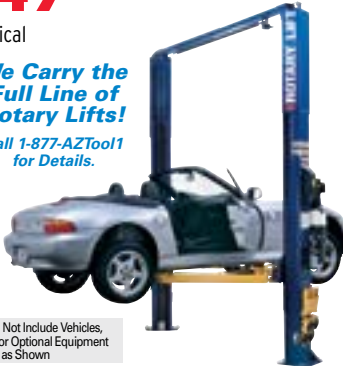

Challenger SA10 10,000 Lbs. 2 Post Vehicle Lift

SKU 847098
CHLSA10 **2,899⁹⁹**

- Can Be Configured in Either the Symmetric or Asymmetric Position
- 3 Stage Front Arms Provide Greater Overall Arm Sweep
- Double Telescoping Screw Pads to Minimize the Need for Adapters

Symmetrical Column Orientation

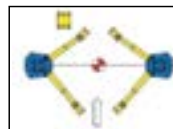

Asymmetrical Column Orientation

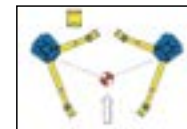

Price Does Not Include Vehicles, Installation or Optional Equipment as Shown



Challenger E12 12,000 Lbs. 2 Post Heavy Duty Lift

SKU 344994
CHLE12 **4,849⁹⁹**

- 2-Stage Telescoping Arms Provide Excellent Reach to Accommodate Vehicle Lifting Points
- 13' 10" or 14' 7" Adjustable Column Height
- Heavy-Duty Telescoping Screw Pads

Price Does Not Include Vehicles, Installation or Optional Equipment as Shown



10,000 Lbs. 2 Post Lift

SKU 298485
CHLCL10V3 **3,999⁹⁹**

Versymmetric 3 Stage Arms

- Column Height: 11' 8"
- Adjustable Width Overall: 11' 6-1/2" / 11' 11"
- Floor to Overhead Switch: 134.5"
- Ceiling Height Required: 11' 11"
- Drive-Thru Clearance: 100" / 104-1/2"

Price Does Not Include Vehicles, Installation or Optional Equipment as Shown



Designed to Lift Anything From a Compact Car to a Full Size Truck.

Leasing Terms Available.*
Ask Your AutoZone® Commercial Sales Manager.
Free Delivery!
in 48 Continental United States

Challenger CL12, 12,000 Lbs. 2 Post Symmetric Lift

SKU 750127
CHLCL12 **6,299⁹⁹**

- Lifts Heavy Duty PU's to Small Sedans
- 3 Stage Front and 3 Stage Rear Arms Provide Greater Extension and Retraction
- Rise Height: 84 3/4" (2153mm)
- Ceiling Height Required: 13' 9"

Price Does Not Include Vehicles, Installation or Optional Equipment as Shown



12,000 Lbs. F12N300 2 Post Lift

SKU 818751
FORF12N300BL **4,299⁹⁹**

- 2 Stage Arms Reach: 35" to 54"
- Accommodates Trucks and Many Cars
- Low Profile 4-3/4" Adapters
- Includes Four 3.5" and 5" Adapter Extenders
- Warranty: 60 Days Labor, 18 Months Parts, 5 Years Structural

Height Configurations of 11'-10", 12'-10", and 14'-10" are Available

Price Does Not Include Installation or Optional Equipment as Shown

(Truck Adapters Included)



3 Stage Front and Rear Arms

15,000 Lbs. 2 Post Lift

SKU 499669
FORDP015 **7,699⁹⁹**

18,000 Lbs. 2 Post Lift

SKU OUTSIDE BUY/EPO
FORDP18N000BL **11,749⁹⁹**

- Includes Truck Adapter Extensions
- Low Profile Arms
- Overall Height: 14' 7"
- Overall Width: 12' 4"
- Rise: 88-1/2"

(Truck Adapters Included)

Available via Outside Buy/EPO, Call 1-877-298-6651 for ordering instructions.



Price Does Not Include Vehicles, Installation or Optional Equipment as Shown

12,000 Lbs. 2 Post Lift Clearfloor, Triple-Telescope Arms

SKU 296957
BENXPR-12CL **5,199⁹⁹**

- Drop-End Arms Provide a Lower Pad Height
- Triple-Telescoping Front and Rear Arms
- Height Overall: 170"
- Inside Columns: 120"

Price Does Not Include Vehicles, Installation or Optional Equipment as Shown

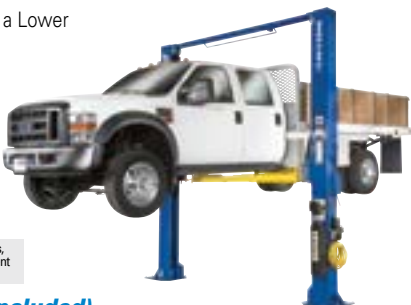

(Truck Adapters Included)

15,000 Lbs. 2 Post Lift, Clearfloor, Standard Arms

SKU 296916
BENXPR-15CL **7,799⁹⁹**

- Taller Column Height Provides Greater Overhead Clearance
- Versatile Drop-In Contact Pads with Stackable 8 Piece Truck and Van Adapters
- Frame Cradle Pads Come Standard
- Two-Stage Telescoping Front and Rear Arms
- Height Overall: 170"
- Inside Columns: 120"
- Includes Frame Cradle Pads Plus Truck and Van Adapter Set

Price Does Not Include Vehicles, Installation or Optional Equipment as Shown



(Truck Adapters Included)

18,000 Lbs. 2 Post Lift, Clearfloor, Standard Arms

SKU 296884
BENXPR-18CL **8,699⁹⁹**

- Taller Column Height Provides Greater Overhead Clearance
- Versatile Drop-In Contact Pads with Stackable 8 Piece Truck and Van Adapters
- Frame Cradle Pads Come Standard
- Two-Stage Telescoping Front and Rear Arms
- Height Overall: 170"
- Inside Columns: 120"
- Includes Frame Cradle Pads Plus Truck and Van Adapter Set

Price Does Not Include Vehicles, Installation or Optional Equipment as Shown



(Truck Adapters Included)

Free Delivery!
in 48 Continental United States

Specifications Subject to Change without Notice or Liability. Customers Responsible for Off-loading Equipment Upon Arrival.
Prices Do Not Include Vehicles, Installation or Optional Equipment as Shown.

Leasing Terms Available.*
Ask Your Sales Rep for Details.

Free Delivery!
in 48 Continental United States

Leasing Terms Available!+

Ask Your AutoZone®
Commercial Sales Manager

AutoZone
Tool & Equipment QUARTERLY

2 Post Floor Plate Lifts

Admiral D-2-9X
SKU 186430
DAN1375646 **2,699⁹⁹**

- Perfect for Shops and Garages with Height Restrictions
- Truck and Van Adapter Set Included
- Height Overall: 113"



Dannmar
EQUIPMENT

Dual-Width, 9,000 Lbs., 2 Post Lift, Floor Plate

SKU 296950
BENXPR-9DS **2,899⁹⁹**

- Adjustable Width Design Configures for Wide or Narrow Installation
- Direct-Drive Lifting System Eliminates Chains and Pulleys
- Large, 20" x 19" Steel Base Plates
- Height Overall: 145"
- Inside Columns: 105" 118"



Price Does Not Include Vehicles, Installation or Optional Equipment as Shown

(Truck Adapters Included)

Dual-Width, 9,000 Lb. 2 Post Lift, Floor Plate, Short Lift

SKU 296813
BENXPR-9S **2,949⁹⁹**

- Shorter Column for Low-Ceiling Installations
- Adjustable Width Design Configures for Wide or Narrow Installation
- Large, 20" x 19" Steel Base Plates
- Height Overall: 113"
- Inside Columns: 105"-118"



Price Does Not Include Vehicles, Installation or Optional Equipment as Shown

(Truck Adapters Included)

Low-Profile Arms, Dual-Width, 9,000 Lbs. 2 Post Lift, Floor Plate, Short Lift

SKU 296927
BENXPR-9S-LP **2,999⁹⁹**

- Shorter Column for Low-Ceiling Installations
- Adjustable Width Design Configures for Wide or Narrow Installation
- Telescoping Low-Pro™ Arms Accommodate Lowered Sports Cars
- Large, 20" x 19" Steel Base Plates
- Height Overall: 113"
- Inside Columns: 105"-118"



(Truck Adapters Included)

Price Does Not Include Vehicles, Installation or Optional Equipment as Shown

9,000 Lbs. 2 Post Lift

SKU 499660
FORBP9 **3,199⁹⁹**

- Minimum Ceiling Height: 113"
- Overall Width: 138-1/2" (3,518 mm)
- Overall Height: 111-1/4" (2,826 mm)
- Minimum Adapter Height: 3-1/2"
- Adapter Extenders Included
- ETL Certified

Low Ceilings Are No Problem!

Price Does Not Include Installation or Optional Equipment as Shown



(Truck Adapters Included)

Challenger CLFP9 9,000 Lbs. Floor Plate 2 Post Lift

SKU 851779
CHLCLFP9 **3,399⁹⁹**

- 3 Stage Front and Rear Arms Provide Excellent Reach to Lift a Variety of Vehicles
- Drive-Thru Clearance: 98-3/16"
- Ceiling Height Required: 121-7/8"
- Double Telescoping Screw Pads Adjust to Multiple Heights Minimizing the Need for Adapters



Price Does Not Include Vehicles, Installation or Optional Equipment as Shown

12,000 Lbs. Floorplate, Direct-Drive 2 Post Lift

SKU 297199
BENXPR-12FDL **5,049⁹⁹**

- Open-Top Eliminates Overhead Obstruction
- Versatile Drop-In Contact Pads with Stackable 8-Piece Truck and Van Adapters
- Frame Cradle Pads Come Standard
- Triple-Telescoping, Low-Profile Arms
- Height Overall: 144"
- Inside Columns: 118"



(Truck Adapters and Frame Cradle Pads Included)

Price Does Not Include Vehicles, Installation or Optional Equipment as Shown

QuickCycle™: Rise Time 27 Seconds!

CL10 Versymmetric 10,000 Lbs. 2 Post Dual Pendant Controls QuickCycle™ Lift

SKU 851780
CHL10V3DPCQC **5,399⁹⁹**

- Featuring Dual Pendant Control System – Operate Lift From Either Column
- Versymmetric 3 Stage Front and 3 Stage Rear Arms
- Safely Lift Everything From Small Sedans to Trucks and SUVs
- Comes Standard with a Full Set of Adapters and Adjustable Foot Pads

Price Does Not Include Vehicles, Installation or Optional Equipment as Shown



Express Solution CL10-XP9 9,000 Lbs. QuickCycle™ 2 Post Pad Lift

SKU 851783
CHLCL10XP9QC **6,799⁹⁹**

- 2-1/4" Platform Height
- Open Front and Rear for Complete Vehicle Access
- Come Standard with a Full Set of Rubber Spotting Blocks



Price Does Not Include Vehicles, Installation or Optional Equipment as Shown

2 Post Lift Accessories

Rubber 2 Post Lift Pad/ Slip Over/ Round - 1 Each

SKU 343396
BEN5715017 **24⁹⁹**

- Slip Over Rubber Lift Pad for Use with Bendpak 2 Post Lifts with Round Flat Contact Pads (Sold Individually)



I10 2 Post Carriage Door Bumper Kit

SKU 568451
FORTPB10-D1 **59⁹⁹**

- Use with Forward FORI10



Round Rubber Lift Pad Assembly Drop-In (1 Each)

SKU 343397
BEN5215507 **59⁹⁹**

- Works with Any BendPak 2 Post Lift
- 1 Lift Pad
- 5" Diameter for Enhanced Stability
- Easy Drop-In Design



Square Rubber Arm Pads (1 Each)

SKU 898880
BEN5715365 **24⁹⁹ Each**

- Works with Any BendPak 2 Post Lift
- 5-5/8" Square
- 1-1/16" Thick

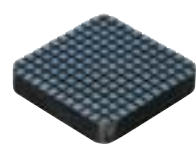

Frame Cradle Pad (1 Each)

SKU 466304
BEN5215506 **54⁹⁹**

- Perfect for Use with Any BendPak 2 Post Lift
- Tactile Rubber Mat Reduces Slippage and Protects Finish



I10 Rubber Adapter Pad Kit

SKU 568440
FOR994105 **99⁹⁹**

- Use with Forward FORI10
- Eliminates Metal to Metal Contact at Vehicle Lift Points
- Includes (4) Pads and Attaching Hardware



Dannmar Frame Cradle Pad (1 Each)

SKU 289999
DAN119527 **49⁹⁹**

- Perfect for Use with Any BendPak 2 Post Lift
- Tactile Rubber Mat Reduces Slippage and Protects Finish



I10 2 Post Lift Adjustable Adapters (Set of 4)

SKU 568450
FORT100285 **299⁹⁹**

- Use with Forward FORI10
- Included Rubber Pad Eliminates Metal to Metal Contact
- Adapters Have Ears to Cradle Frames



Don't Let the Tire Make You Tired!

Omega Wheel Arm™

SKU 573207
OMG92100 **89⁹⁹**

- Holds the Tire at Lift Arm Height and is Handy with Tire Rotations and Brake Jobs
- Easy and Safe for Mechanics to Put On or Take Off Tires
- Avoid Bending Over to Put Down or Pick Up a Tire
- Fits Most Lift Arms 3" - 5" Wide
- Set Includes (2) Wheel Arms and (2) Magnetic Tool Trays



Price Does Not Include Tires or Rims as Shown

INCLUDES:
2 Round Magnetic Trays

Set of 2

\$19⁹⁹ Value



4 Post Lift Accessories

2 Drip Trays

SKU 301768
BEN5700301 **69⁹⁹**



Caster Wheel Set

SKU 898905
BEN5210997 **289⁹⁹**

- For Use on HD-9 Series Lift Only



Rolling Oil Drain

SKU 898714
BENDP-30 **379⁹⁹**

- Adjustable Width: 33" - 60"



Free Delivery!
in 48 Continental United States

Specifications Subject to Change without Notice or Liability. Customers Responsible for Off-loading Equipment Upon Arrival.

Prices Do Not Include Vehicles, Installation or Optional Equipment as Shown.

Leasing Terms Available.
Ask Your AutoZone® Commercial Sales Manager.

AUTOMOTIVE LIFTS

4 Post Lifts

Major D-12™ 12,000 Lbs. 4 Post Lift

SKU 343410
DAN1375681 **3,799⁹⁹**

- Single Hydraulic Cylinder Mounted Underneath Runway
- Internal "Anti-Sway" Slider Blocks in Each Column
- Features Heavy Duty 1/2" Aircraft Cable
- Oversized Self-Lubricating Cable Rollers
- Rugged 1-3/8" Roller Axles
- Multi-Position Safety Locks in Each Column
- Ramps Feature Non-Skid Surface Column
- Push-Button Safety Release Runways Adjust for Different Tread Widths



Dannmar
EQUIPMENT

14,000 Lbs. 4 Post Lift

SKU 898152
BENHDS14 **4,449⁹⁹**

- Overall Width: 130"
- Overall Length: 241"
- Max. Rise: 70"
- Motor: 220 VAC/1 Ph



BendPak

4 Post 6,000 Lbs. Rolling Bridge Jack DRJ-6

SKU 343411
DAN1375901 **999⁹⁹**



RJ-7 7,000 Lbs. Capacity Rolling Bridge Jack

SKU 212556
BENRJ-7 **1,319⁹⁹**



14,000 Lbs. 4 Post Lift

SKU 696483
FORCR14N100 **4,499⁹⁹**

- Heavy Duty Hydraulic Cylinder
- Single Point Latch Release System
- 78-3/4" Rise
- 18 Lock Positions
- Accommodates 182.5" Wheelbase Vehicles
- High Performance Cable and Sheave System
- ETL Certified - Model Shown is CR14N100



FORWARD
LIFT

Challenger 4P14 14,000 Lbs. 4 Post Lift

SKU 851781
CHL4P14EFX **4,899⁹⁹**

- Louvered Approach Ramps for Positive Vehicle Traction
- Adjustable Runways to Accommodate a Variety of Tread Widths
- Column Height: 90-1/2"
- Minimum Bay Size: 12' x 24'

Rolling Jacks Sold Separately

Price Does Not Include Vehicles, Installation or Optional Equipment as Shown



CL Challenger Lifts

18,000 Lbs. 4 Post General Service Lift

SKU 568426
FORCR18 **7,999⁹⁹**

- Max. Wheelbase: 194"
- Durable Cable and Sheave System
- ETL Certified to ANSI/ALI ALCVT: 2011

18,000 Lbs. Long Wheelbase 4 Post Lift

SKU 568427
FORCR18LW **8,799⁹⁹**

- Max. Wheelbase: 230"



FORWARD
LIFT

7,000 Lbs. Rolling Jack

SKU 568445
FORRRJ70G **1,999⁹⁹**



7,500 Lbs. Rolling Jack

SKU 264847
CHLRJ75 **2,054⁹⁹**



9,000 Lbs. Rolling Jack

SKU 568446
FORRJ901000 **2,999⁹⁹**



NEW
SAVE \$1,000

Two 7K Rolling Jacks
SKU 434708
FORRRJ70GBOGO **2,999⁹⁹**
• Great Savings - Buy 1st RJ7.50G at Regular Price, Get the Second One 1/2 Price
• Includes 2, Air/Hydraulic Rolling Jacks with (4) 3" Stack Adapters

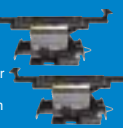

SAVE \$945

Two 7.5K Rolling Jacks
SKU 851169
CHLRJ75BOGO **2,999⁹⁹**
• Includes (2), Air/Hydraulic Rolling Jacks with (4) 3" Stack Adapters
• 7,500 Lbs. Capacity for 4P14 & 4015 Series 4 Post Lifts



NEW
SAVE \$1,500

Two 9K Rolling Jacks
SKU 435068
FORRJ9010BOGO **4,499⁹⁹**
• Great Savings - Buy 1st RJ901000 at Regular Price, Get the Second One 1/2 Price
• Includes 2, Air/Hydraulic Rolling Jacks with (4) 3" Stack Adapters



Storage Lifts

9,000 Lbs. Free Standing or Surface Mounted 4 Post Lift - Standard Height

SKU 264504
CHLQ4P09H **3,499⁹⁹**

- Rise Height to Top of Runway: 73-1/2"
- Outside to Outside Columns: 112"
- Overall Length (with Ramps Attached): 209"
- Inside Columns: 95"
- Height of Columns: 84-1/2"
- Width of Runways: 20"
- Height of Runways: 7"
- Width Between Runways: 38"
- Length of Runways: 164"



Price Does Not Include Vehicles, Installation or Optional Equipment as Shown

Private Lifts

9,000 Lbs. 4 Post Lift

SKU 898142
BENHD-9 **2,949⁹⁹**

- Overall Width: 116-3/4" / 2,965 mm
- Overall Length: 200" / 5,080 mm
- Column Height: 88" / 2,235 mm
- Max. Lifting Height: 74-1/2" / 1,892 mm



Price Does Not Include Vehicles, Installation or Optional Equipment as Shown

Rolling Jacks Sold Separately

9,000 Lbs. 4 Post Lift

SKU 499672
FOREFP9 **3,399⁹⁹**

- Includes: Steel Approach Ramps, Jack Tray, Wheel Caster Kit and Drip Trays
- Single Point Lock Release
- Internal Lock System
- ETL Certified



Price Does Not Include Vehicles, Installation or Optional Equipment as Shown

Rolling Jacks Sold Separately

8,000 Lbs. EFP8 Home Storage 4 Post Lift

SKU 818781
FOREFP8P000M **2,799⁹⁹**

- Perfect for Home Use
- Detachable Ramps Included
- Casters, Jack Tray and Drip Trays Included
- Wired to Plug Into 115V Receptacle



Price Does Not Include Vehicles, Installation or Optional Equipment as Shown

Rolling Jacks Sold Separately

7,000 Lbs. 4 Post Home Storage / Light-Duty Service Lift

SKU 383185
CHLQ4P07 **3,199⁹⁹**

- Rise Height Underneath Runway: 63"
- Outside to Outside Columns: 100"
- Overall Length (with Ramps) (without Ramps) 165"
- Inside Columns: 92"
- Height of Columns: 79-1/2"
- Width of Runways: 20"
- Height of Runway: 5 3/4"
- Width Between Runways: 38"
- Length of Runways: 150"
- Detachable Aluminum Approach Ramp Length: 36"
- 13 Lock Positions
- 1HP 110 Volt Plug-In or 220V Power



Price Does Not Include Vehicles, Installation or Optional Equipment as Shown

Rolling Jacks Sold Separately

Commander D-7

SKU 186464
DAN1375643 **2,449⁹⁹**

- Spring-Loaded Safety Locks on Each Column
- Self-Lubricating UHMW Polyethylene Internal Slide Blocks
- Single Safety Lock Release Handle
- 7,000 Lbs. Capacity Free Standing Design
- Detachable Drive-Up Ramps Included



Price Does Not Include Vehicles, Installation or Optional Equipment as Shown

Rolling Jacks Sold Separately

4,500 Lbs. Hand/Hydraulic Operated Rolling Jack

SKU 264841
CHLQRJ04H **899⁹⁹**



RJ-45 4,500 Lbs. Capacity Rolling Bridge Jack

SKU 898534
BENRJ-45 **1,194⁹⁹**

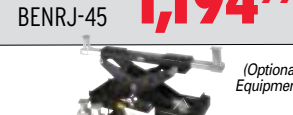

4,500 Lbs. Rolling Jack

SKU 568432
FORRRJ45G **999⁹⁹**

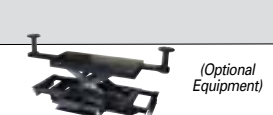

3,500 Lbs. RJ35BK Hand Pump Rolling Jack

SKU 818764
FORRJ35BK **699⁹⁹**



4,500 Lbs. Hand/Hydraulic Operated Rolling Jack

SKU 383186
CHLQRJ03H **599⁹⁹**



Jack Platform

SKU 186438
DAN119442 **139⁹⁹**



Free Delivery!
in 48 Continental United States

Specifications Subject to Change without Notice or Liability.
Prices Do Not Include Vehicles, Installation or Optional Equipment as Shown.

Customers Responsible for Off-loading Equipment Upon Arrival.
Ask Your Sales Rep for Details.

Leasing Terms Available.†
Ask Your AutoZone® Commercial Sales Manager.

Leasing Terms Available!+

Ask Your AutoZone®
Commercial Sales Manager

AutoZone
Tool & Equipment QUARTERLY

Lift Accessories

Air/Electric Workstation for 2 and 4 Post Lift

SKU 751635
DAN1980999
239⁹⁹

- Add 20 Amp Outlets, Air Functionality and Tool/Line Holders by Attaching This Workstation to Your 2 Post Lift



Air/Electric Workstation

SKU 898684
BENWSA-100 **314⁹⁹**

- Adds Air and Electric Capabilities to Any BendPak Lift Simple, Safe and Extremely Easy-to-Use
- (4) 110V GFI Outlets, Oiler, Air Supply, Pressure Gauge, Storage Hooks for Hose and Tools, Regulator/Filter, Air Inlet
- Fits 2 or 4 Post Lifts

You Will Need to Know BendPak Lift Model # When Ordering



Air/Electric Workstation for 4 Post Lifts

SKU 263294
CHLI0310
349⁹⁹

- Convenient Power Source for Extension Lights and Other Tools
- Air Supply Will Always Be at Arms Reach for Facilities Using Pneumatic Tools Such as Impact Wrenches



Air/Electric Workstation

SKU 568448
FOR991359
369⁹⁹

- Use with Forward FOR110
- Air/Electric Workstation with Air Regulator and Oiler

Does Not Include Hose and Air Gun



Mid-Rise Lifts

Cadet-6000XL

SKU 555446
DAN1375652 **1,749⁹⁹**

- For Servicing Light-Duty Cars and Trucks
- Portable Motor Cart Serves as Tow Handle
- Adjustable Arm Assemblies
- Safety Bar with Multiple Lock Positions



Lift Gate Service
SKU 262534
DANLIFTGATE **100⁰⁰**



Price Does Not Include Vehicles, Installation or Optional Equipment as Shown

6,000 Lbs. Portable Mid Rise Lift

SKU 264835
CHLQMR6 **2,099⁹⁹**

- Rise Height 53 1/4"
- Includes Both 3" and 6 7/8" Adapters

Lift Gate Service
SKU 295540
DEMLIFTGATE **80⁰⁰**



Price Does Not Include Vehicles, Installation or Optional Equipment as Shown

6,000 Lbs. Surface Mount Mid-Rise Pad Lift

SKU 079537
BENMDS-6K **2,449⁹⁹**

- For Servicing Passenger Cars, SUVs and Light-Trucks
- Lifting Height (Less Lift Blocks): 44"
- Comes with Four Rubber Contact Blocks Providing Fast Vehicle Set-Up

6,000 Lbs. Flush Mount Mid-Rise Pad Lift

SKU 079653
BENMDS-6KF **2,349⁹⁹**

- Fully Open Center Design for Servicing Passenger Cars, SUVs and Light-Trucks
- Lifting Height (Less Lift Blocks): 44" (4.25" for Sub Floor)
- Includes Four Rubber Contact Blocks Providing Fast Vehicle Set-Up



6,000 Lbs. Mid-Rise Lift

SKU 499655
FOR600MRL **1,999⁹⁹**

- Width: 41"
- Rise: 52"
- Multiple Locking Positions
- Truck Adapters Included

Lift Gate Service
SKU 626137
FORLIFTGATE **95⁰⁰**



Price Does Not Include Vehicles, Installation or Optional Equipment as Shown

6,000 Lbs. Portable Mid-Rise Lift

SKU 210386
BENMD-6XP **2,094⁹⁹**

- Portable, Easy to Move From Bay-to-Bay
- Adjustable Arms
- Lifting Capacity: 6,000 Lbs.

Lift Gate Service
SKU 262533
RANLIFTGATE **135⁰⁰**

(Truck Adapters Included)



Price Does Not Include Installation or Optional Equipment as Shown

MaxJax

SKU 186434
DAN1375659 **1,999⁹⁹**

- Perfect for Low Clearance Ceilings and Home Garages
- Built-In Wheels That Allow You to Store it Out of the Way When Not in Use
- Max. Lift Height (with 3" Adapter): 52"

Lift Gate Service
SKU 262534
DANLIFTGATE **100⁰⁰**



Price Does Not Include Vehicles, Installation or Optional Equipment as Shown

Low-Rise Lifts

6,000 Lbs. Low-Rise Pad Lift

SKU 210383
BENLR-60 **1,739⁹⁹**

- Max. Height: 26"
- Overall Width: 70"
- Overall Length: 82"

Lift Gate Service
SKU 262533
RANLIFTGATE **135⁰⁰**

Price Does Not Include Vehicles, Installation or Optional Equipment as Shown



Portable

SKU 210384
BENLR-60P **1,819⁹⁹**

- Max. Height: 26"
- Overall Width: 70-1/2"
- Overall Length: 82"

7,000 Lbs. Low-Rise Pad Lift

SKU 568436
FORTL07 **2,349⁹⁹**

- Wired to Plug Into 115V Receptacle
- Max. Rise: 24-3/4"

Lift Gate Service
SKU 626137
FORLIFTGATE **95⁰⁰**



Price Does Not Include Installation or Optional Equipment as Shown

10,000 Lbs. Low-Rise Pad Lift

SKU 479989
BENLR-5T **2,799⁹⁹**

- Max. Height: 23" - 32"
- Lowered Height: 4"
- Lift Blocks Included

32"



Price Does Not Include Installation or Optional Equipment as Shown

QuickJack™

5,000 Lbs. QuickJack™ Car Jack Support System

SKU 850896
RANBL5000SLXA (110V AC) **1,339⁹⁹**

- Complete Package Includes: (2) Ea. Jack Frame Assemblies, (2) Ea. 150" Hydraulic Hoses, (2) Ea. 14" Aux. Hoses, (2) Ea. Quick-Mount Handles, (4) Ea. 1.5" X 3" X 4" Rubber Lifting Blocks, (4) Ea. 3" X 3" X 4" Rubber Lifting Blocks, (1) Mini Hydraulic Power Unit with Pendant Control.

Price Does Not Include Vehicles, Installation or Optional Equipment as Shown.

You get it all.

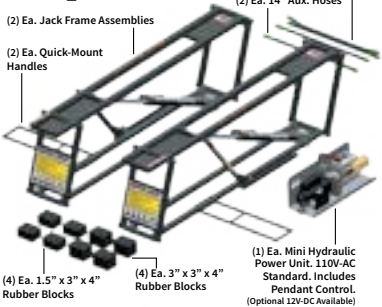

(2) Ea. Jack Frame Assemblies
(2) Ea. Quick-Mount Handles
(2) Ea. 150" Hydraulic Hoses
(2) Ea. 14" Aux. Hoses
(4) Ea. 1.5" x 3" x 4" Rubber Blocks
(4) Ea. 3" x 3" x 4" Rubber Blocks
(1) Ea. Mini Hydraulic Power Unit, 110V-AC Standard, Includes Pendant Control, (Optional 12V-DC Available)

SPECIFICATIONS:

	BL-3500SLX	BL-5000SLX	BL-7000SLX
Weight Capacity / Pair	3,500 Lbs. / 1588 kg.	5,000 Lbs. / 2268 kg.	7,000 Lbs. / 3175 kg.
Individual Frame Weight:	60 Lbs. / 27 kg.	76 Lbs. / 34 kg.	91 Lbs. / 41 kg.
Platform Lifting Height (Frame Only)	16.5" / 419 mm.	17.2" / 437 mm.	17.7" / 450 mm.
Platform Lifting Height (W/Blocks)	20" / 508 mm.	22.5" / 572 mm.	21.2" / 538 mm.
Minimum Collapsed Height	3" / 76 mm.	3" / 76 mm.	3.5" / 89 mm.
Rubber Block Position Min	26.7" / 678 mm.	31.5" / 800 mm.	31.5" / 800 mm.
Rubber Block Position Max	50.5" / 1283 mm.	60" / 1524 mm.	60" / 1524 mm.
Frame Width	10.5" / 267 mm.	11" / 278 mm.	12.5" / 318 mm.
Frame Length	62" / 1575 mm.	72.5" / 1841 mm.	72.5" / 1841 mm.
Lifting Time	10 seconds	15-30 seconds	15-30 seconds

3,500 Lbs. QuickJack™

SKU 850894
RANBL3500SLXA (110V AC) **1,124⁹⁹**

SKU 850897
RANBL7000SLXA (110V AC) **1,489⁹⁹**

Includes:
QuickJack™ SUV and Light Truck Adapters
SKU 862288 | RAN5150561
Value: \$219.99

12V DC Option Available

QUICKJACK™

QuickJack™ SUV and Light Truck Adapters

SKU 862288
RAN5150561 **219⁹⁹**

- Set of 12 Pieces
- Fits BL-5000 and BL-7000 Series
- Complete Kit Includes: (4) Low-Profile Round Polyurethane Contact Pads (4) Sliding Receivers Accommodate the Round Polyurethane Contact Pads (4) 3" Stackable Adapters



Motorcycle Lifts

Motorcycle Jack

SKU 568452
FORBJ10 **194⁹⁹**

- Use with Forward FOR100MCL



1,000 Lbs. Air Operated Motorcycle Lift

SKU 499659
FOR100MCL **1,049⁹⁹**

- Includes Wheel Vise and Two 12" Extensions, Making it Great for Motorcycles, ATVs, Lawn Mowers, Golf Carts, Etc.
- Rise: 33", Length 93", Width 24", Width with ATV Adapters 48"

Lift Gate Service
SKU 626137
FORLIFTGATE **95⁰⁰**

Price Does Not Include Vehicles, Installation or Optional Equipment as Shown



1,000 Lbs. Droptail Motorcycle Lift

SKU 568439
FOR100MCLDT **1,249⁹⁹**

- FORBJ10 Included
- Rise 33" Length 93", Width 24"

Lift Gate Service
SKU 626137
FORLIFTGATE **95⁰⁰**

Price Does Not Include Vehicles, Installation or Optional Equipment as Shown



Motorcycle Lift

SKU 626120
RANRML-1500XL **1,449⁹⁹**

- Lifting Capacity: 1,500 Lbs. / 682 kg Power Supply: Air/Hydraulic
- Main Platform Length: 89" / 2,286 mm
- Main Platform Length with Front Extension: 102" / 2,591 mm
- Main Platform Width: 30" / 762 mm

Lift Gate Service
SKU 262533
RANLIFTGATE **135⁰⁰**

Price Does Not Include Vehicles, Installation or Optional Equipment as Shown



AUTOMOTIVE LIFTS

TUXEDO
Distributors, LLC.
Automotive Equipment & Accessories

Tuxedo Distributors, LLC, is a leading importer of high quality automotive repair equipment offering a full line of automotive equipment at an economical price. With our 15 satellite warehouses strategically located across the US, we offer an unparalleled competitive advantage.

Call to place order!
817.558.9337
877.558.9337 Toll Free

TWO POST LIFTS

TLT240SC-R 2,099⁹⁹
9,000lbs CAPACITY
SKU 426404

TLT240SB-R 1,999⁹⁹
9,000lbs CAPACITY
SKU 426403

- 9,000 lb. lifting capacity
- Overall Height: 151" (TLT240SC)
- Overall Width: Symm 134", Asym 140" (TLT240SC)
- Overall Height: 113" (TLT240SB)
- Overall Width: 133" (TLT240SB)
- Rubber Door Guards
- Hose Guards
- Dual Point Lock Release
- Heavy-Duty Arm Restraint System
- Double Telescoping Screw Pads
- Adjustable Column Width (TLT240SC)
- Standard or Rotated Asymmetric Columns (TLT240SC)

LAUNCH



TLT240SC-R
Clear Floor Model

TLT240SB-R
Floorplate Model

TP9KAC 1,849⁹⁹
9,000lbs CAPACITY
SKU 426138

TP9KF 1,849⁹⁹
9,000lbs CAPACITY
SKU 426106

- 9,000 lb. lifting capacity
- Overall Height: 142" (TP9KAC)
- Overall Width: 141" (TP9KAC)
- Overall Height: 111-1/2" (TP9KF)
- Overall Width: 141" (TP9KF)
- Chain Driven
- Dual cylinders with low friction chain rollers
- Low profile arms
- 1-1/2" and 5" stackable drop-in height adapters
- Automatic safety cut-off bar (TP9KAC)
- Mounting Hardware included
- Powder-Coated Finish



TP9KAC
Clear Floor Model

TP9KF
Floorplate Model

Price Does Not Include Installation or Optional Equipment as Shown

TLT210-XT-B 2,799⁹⁹
10,000lbs CAPACITY
SKU 426407

- 10,000 lb. lifting capacity
- Overall Height: 149"
- Overall Width: Symm 137", Asym 138"
- Heavy-Duty Arm Restraint System
- Adjustable Column Height
- Adjustable Column Width
- Outer Hose Guards
- Stackable Foot Pad Extensions two 0" and two 3"
- 3 Stage Front Arms
- Rubber Door Guards
- Single Point Lock Release
- Standard or Rotated Asymmetric Arm Configuration
- Double Telescoping Screw Pads offering 0.5" adjustment for complete vehicle coverage

LAUNCH TECH USA



Standard Asymmetric Arm Configuration



Rotated Asymmetric Arm Configuration

TP11KC-DX 2,599⁹⁹
11,000lbs CAPACITY
SKU 426140

- 11,000 lb. lifting capacity
- Direct Drive Cylinders
- Overall Height: 145"
- Overall Width: 145-1/2"
- 3 Stage Front Arms, Low Profile Arms
- Asymmetric/Symmetric Arm Configuration
- Symmetric Columns
- Single Point Lock Release
- Rubber Door Guards
- Mounting Hardware included
- Spin Up Pads with 2" and 4" stackable drop in Truck Adapters
- Powder-Coated Finish

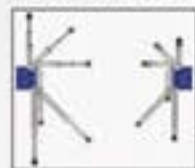

BI-SYMMETRIC™ DESIGN
Asymmetric/Symmetric arm configuration with 180 degree front arm rotation.



Price Does Not Include Installation or Optional Equipment as Shown

TP12KC-DE 3,999⁹⁹
12,000lbs CAPACITY
SKU 426331

- 12,000 lb. lifting capacity
- Overall Height: 165"
- Overall Width: 151-1/8"
- Direct Push Drive Cylinders
- Extra Long (45") carriage
- Padded overhead cut-off bar
- Single Point Pneumatic Lock Release
- 2-1/2" and 5" Stackable Drop in Adapters
- Mounting Hardware included
- Powder-coated finish

IDEAL™



Price Does Not Include Installation or Optional Equipment as Shown

Price Does Not Include Installation or Optional Equipment as Shown

SERVICE LIFT

FP14K-C 4,749⁹⁹
14,000lbs CAPACITY
Service Lift
SKU 426438

- 14,000 lb. lifting capacity
- Overall Height: 68-7/8"
- Overall Width: 136-3/4"
- Overall Length: 250-1/2"
- Cable Driven
- Closed Front
- Single point pneumatic safety release
- 20" wide non-skid, diamond plate runways
- Mounting Hardware included
- Powder-Coated Finish

Also sold as an Alignment Lift



Price Does Not Include Installation or Optional Equipment as Shown

BRIDGE JACK

RAJ-8K-L 1,449⁹⁹
8,000lbs CAPACITY
SKU 426452

- Universal Roller Body Design with dual 'spring loaded' precision roller bearing and Side Guide Wheels w/adjustable Height for Low, Medium, and High Jack Rail Configurations
- Rolls on top edge of Jack Rail for smooth maneuverability
- Dual Height Telescoping Support Arms
- Pneumatic operation w/adjustable Pressure Regulator
- Stackable Pad and Height Adapters 1 5/16" and 5" (1 Pair each)
- Dual Air Bags



Price Does Not Include Installation or Optional Equipment as Shown

STORAGE LIFT

FP8K-DS 2,399⁹⁹
8,000lbs CAPACITY
SKU 426414

- 8,000 lb. capacity
- Overall Height: 96-1/4"
- Overall Weight: 103-1/2"
- Overall Length: 207-1/8"
- Ladder lock safety system with "auto engage" locking bar
- Extra-large slider blocks for added stability
- 10 Lock Positions
- Aircraft quality cables
- Single Point Lock Release
- 18" Wide non-skid, diamond plate runways
- Casters, Jack Tray, and Approach Ramps included



Price Does Not Include Installation or Optional Equipment as Shown

WHEEL SERVICE

TC-530 1,399⁹⁹
Semi-Automatic
Tire Changer
SKU 426751

- Internal Clamping Capacity: 12" - 23"
- External Clamping Capacity: 18" - 20"
- Max Wheel Diameter: 35"
- Wheel Width: 3" - 12"
- Swing arm design
- Bead seating inflation jets are integrated in the clamping jaws
- Side mounted Bead Breaker



Price Does Not Include Installation or Optional Equipment as Shown

TC-950 1,599⁹⁹
Semi-Automatic
Tire Changer
SKU 426755

- Internal Clamping Capacity: 15" - 28"
- External Clamping Capacity: 13" - 24"
- Max Wheel Diameter: 47"
- Wheel Width: 3" - 15"
- Swing arm design
- Bead seating inflation jets are integrated in the clamping jaws
- Twin clamping cylinders provide more power to hold the most difficult rims
- Conveniently located and powerful bead breaker
- Large diameter hex mount/demount shaft for extra rigidity
- Left side press arm (WPA)
- Ideal for low profile tires (WPA)
- No scratching, machine never contacts rim (WPA)



Price Does Not Include Installation or Optional Equipment as Shown

Price Does Not Include Installation or Optional Equipment as Shown

WB-953 1,149⁹⁹
High Performance
Wheel Balancer
SKU 426803

- Max Wheel Diameter: 32"
- Rim Width: 1.5" - 20"
- Rim Diameter: 10" - 24"
- Wheel Weight Capacity: 143 lbs
- Self-calibrating
- Optimization program
- Static balancing
- Three centering cones
- Speed nut and caliper standard



Price Does Not Include Installation or Optional Equipment as Shown

Price Does Not Include Installation or Optional Equipment as Shown

WB-448 2,499⁹⁹
Heavy Duty Truck
Wheel Balancer
SKU 426811

- Max Wheel Diameter: 47"
- Rim Width: 1.5" - 20"
- Rim Diameter: 10" - 24"
- Wheel Weight Capacity: 290 lbs
- Self-calibrating, Self-diagnosis
- Pneumatic Wheel lift included
- Foot brake for manual stop
- Capable of balancing a full range of wheels
- Car and Truck cones come standard



Price Does Not Include Installation or Optional Equipment as Shown

Leasing Terms Available!+

Ask Your AutoZone®
Commercial Sales Manager

AutoZone
Tool & Equipment QUARTERLY

Dannmar
EQUIPMENT

PORTABLE LIFT

MaxJax™
SKU 186434
DAN1375659 **1,999⁹⁹**

- Lifting Capacity: 6,000 lbs
- Overall Height: 89"
- Fully Adjustable Lift Arms
- Easy Set-Up and Use



Price Does Not Include Vehicles, Installation or Optional Equipment as Shown

2-POST LIFTS

D-9/X
SKU 186430
DAN1375646 **2,699⁹⁹**

- Lift Capacity 9,000 lbs
- Floorplate Style
- Overall Height: 113"
- Rise: 74"



Price Does Not Include Vehicles, Installation or Optional Equipment as Shown

D-10/AC
SKU 186431
DAN1375648 **2,499⁹⁹**

- Lifting Capacity: 10,000 lbs
- Overall Height: 145"
- Rise: 69"
- Overall Width: 130-1/2"
- ASYMMETRIC WIDE



Price Does Not Include Vehicles, Installation or Optional Equipment as Shown

D-10/ACX
SKU 186433
DAN1375647 **2,499⁹⁹**

- Overall Width: 143-1/2"
- ASYMMETRIC WIDE

D-10/CX
SKU 186432
DAN1375649 **2,499⁹⁹**

- Overall Width: 145"
- SYMMETRIC WIDE

ALIGNMENT LIFT

D-12A COMBO
SKU 079778
DAN1381815 **6,499⁹⁹**

- Includes the D 12A 12,000 Lbs. 4 Post Alignment Lift along with 2, DRJ-6 Rolling Jacks and Turnplates plus the Matching Airline Kit
- Width: 103"
- Length: 248"

DAN1381815	D-12A Combo	\$6,499.99
DAN1375682	Alignment Lift	\$4,399.99
DAN1375901	Rolling Jack	\$999.99
DAN1375901	Rolling Jack	\$999.99
DAN17057064	Airline Kit	\$219.99
TOTALS		\$6,619.96
SAVINGS		\$119.97



DRJ-6 (Qty 2)
SKU 343411
DAN1375901

AIRLINE KIT
SKU 752035
DAN17057064

Price Does Not Include Vehicles, Installation or Optional Equipment as Shown

SCISSOR LIFT

SX-6/XL
SKU 555446
DAN1375652 **1,749⁹⁹**

- Lifting Capacity: 6,000 lbs
- Max Rise with 6" Adapter: 49.375"
- Max Rise with 3" Adapter: 46.5"
- Shipping Weight: 792



Price Does Not Include Vehicles, Installation or Optional Equipment as Shown

4-POST LIFTS

D-12
SKU 343410
DAN1375681 **3,799⁹⁹**

- Lifting Capacity: 12,000 lbs
- Overall Width: 130"
- Overall Length: 248"
- Max Rise: 66"



Price Does Not Include Vehicles, Installation or Optional Equipment as Shown

D-7
SKU 186464
DAN1375643 **2,449⁹⁹**

- Lifting Capacity: 7,000 lbs
- Visible Locking System
- Overall Length: 203-1/2"



Price Does Not Include Vehicles, Installation or Optional Equipment as Shown

D-7/X
SKU 186427
DAN1375644 **2,479⁹⁹**

- Extended version of D-7
- Overall Length: 227-1/2"

SHOP EQUIPMENT

8-GAL OIL DRAIN
SKU 186458
DAN122829 **99⁹⁹**

- 8-Gal Capacity
- Adjustable Height: 48-67"
- Wide Drain Pipe for Draining Oil Quickly
- Large Funnel Mouth to Catch Oil & Reduce Spillage



20-GAL OIL DRAIN
SKU 343408
DAN122835 **319⁹⁹**

- 20-Gal Capacity
- 15" Drainage Funnel
- Includes Regulator and Gauge



TRIPOD JACK STAND
SKU 186457
DAN105430 **129⁹⁹**

- 2 Ton Capacity
- Extra Tall & Stable
- Min Height : 68.7"
- Max Height: 76.7"



TRANSMISSION JACK
SKU 186451
DAN105452 **479⁹⁹**

- First Stage: 1,000 lbs
- Second Stage: 500 lbs
- Min 34" - Max 71"
- Heavy-Duty Steel Swivel Casters
- Rigorous Safety Overload System
- Controlled Pneumatic Descent for Safe Lowering



ROLLING WORK SEAT
SKU 752040
DAN106625 **59⁹⁹**

- Capacity: 205 lbs
- Depth: 14-1/2"
- Overall Height: 14"



50' HOSE REEL
SKU 343407
DAN116911 **199⁹⁹**

- 50' of 3/8" of Rubber Hose
- Working Pressure: 250psi
- Max CFM: 25
- 4 Way Non-Snag Rollers



LIFT ACCESSORIES

FRAME CRADLE PAD
SKU 289999
DAN119527 **49⁹⁹**

- For 2-Post Lifts
- Sturdy Steel Construction
- Tactile Rubber Mat



LIFT PAD ASSY ROUND
SKU 079518
DAN17107036 **49⁹⁹**

- Works with Dannmar 2-Post Lift
- Thick Rubber Construction
- Easy Drop-In Design
- 5" Diameter



RND SLIP OVER PAD
SKU 752032
DAN17108252 **22⁹⁹**

- Resistant to Gouging
- Abrasion Resistant
- Tear Resistant
- Sold Individually



TURNPLATES
SKU 751634
DAN135501 **359⁹⁹**

- 14" x 13.5" x 2"
- Smooth Bearings
- Sturdy Construction
- Sold Individually



AIR-ELEC WORK STATION
SKU 751635
DAN1980999 **239⁹⁹**

- Works with Any Lift
- 4 110v GFI Outlets
- Oiler, Air Supply, PSI Gauge, Storage Hooks for Hose and Tools, Air Inlet



DRIP TRAYS
SKU 186439
DAN101001 **69⁹⁹**

- Set of 3
- Lightweight Pans
- Intended for Oil & Water-Based Fluids



WHEEL SERVICE

T-100 TIRE CHANGER
SKU 547117
DAN1381202 **1,599⁹⁹**

- Max Wheel Diameter: 50"
- Machine Weight: 507 lbs
- Rim Width: 3-15"
- Inside Clamp: 15-25"
- Outside Clamp: 12-22"



Shown with OPTIONAL Power Assist Arm

B-100 WHEEL BALANCER
SKU 547121
DAN1381201 **1,449⁹⁹**

- Max Wheel Diameter: 44"
- Rim Width: 1.5-20"
- Rim Diameter: 1-28"
- RPM: 140

