

AutoZone®

Tool & Equipment QUARTERLY



Contact Us:
1-877-AZTool1 Phone
 (1-877-298-6651) *Hablamos Español*

April, May and June 2017

ARCTIC COMMANDER RECOVERY / RECYCLE / RECHARGE MACHINES

Mastercool introduces its new ARCTIC COMMANDER line of RRR machines. Equipped with the latest technology, all models come standard with an 8" GUI Command Center. Navigate through all functions, features and instructions with ease. Wi-Fi capabilities allow for real time, interactive communication and troubleshooting.



It's about time somebody introduced R/R/R machines for the 21st century!

COMMANDER1000 Semi-Automatic R134a R/R/R Machine

SKU 471051 **2,999⁹⁹**
 MSC1000

- 8" Command Center
- Wi-Fi Capable
- On-Board Instruction Manual and Refrigerant Database
- Built in Tank Heater
- 3 CFM Vacuum Pump
- R134a
- Vacuum Leak Test



COMMANDER2000 Fully Automatic R134a R/R/R Machine

SKU 471040 **3,899⁹⁹**
 MSC2000

- 8" Command Center
- Wi-Fi Capable
- On-Board Instruction Manual and Refrigerant Database
- Built in Tank Heater
- 6 CFM Vacuum Pump
- R134a
- Wi-Fi Capable
- Vacuum Leak Test
- Includes Dust Cover



COMMANDER3000 R134a and Hybrid R/R/R Machine

SKU 471054 **4,099⁹⁹**
 MSC3000

- 8" Command Center
- Wi-Fi Capable
- On-Board Instruction Manual and Refrigerant Database
- Built in Tank Heater
- 6 CFM Vacuum Pump
- R134a & Hybrid
- Vacuum Leak Test



COMMANDER4000 R1234yf and Hybrid R/R/R Machine

SKU 471061 **5,999⁹⁹**
 MSC4000

- 8" Command Center
- Wi-Fi Capable
- On-Board Instruction Manual and Refrigerant Database
- Built in Tank Heater
- 6 CFM Vacuum Pump
- Built in Refrigerant Identifier
- R1234yf & Hybrid
- Vacuum Leak Test



SEE DETAILS, PAGES 28 >>

Tire Service Combo

T-100 Tire Changer and B-100 Wheel Balancer Combo

SKU 818788 **2,799⁹⁹**
 DAN1381801

- Includes: DAN1381201 Dannmar T-100 Tire Changer and DAN1381202 Dannmar B-100 Wheel Balancer
- This Dannmar Combo is Best Suited for Gas Stations, Small Garages and Auto Salvage Yards. With the T-100 B-100 Combo, You Get Great Value and More Bang for Your Buck
- T-100 - Outside Clamp: 12" - 22"
- B-100 - Rim Diameter: 1" - 28"
- B-100 Includes Data Acquisition Wand and Quick Nut



Dannmar
 EQUIPMENT

DAN1381202

Price Does Not Include Tires or Rims as Shown

DAN1381801		\$2,799.99
DAN1381202	Dannmar T-100 Tire Changer	1,599.99
DAN1381201	Dannmar B-100 Balancer	\$1,449.99
Total		\$3,049.98
Savings		\$249.99

SAVE \$249⁹⁹

Warranty
 1 YEAR Parts Only

Lift Gate Service
 SKU 262534
 DANLIFTGATE **100⁰⁰**

SEE DETAILS, PAGE 36 >>>

Lifts

XPR-10AS Dual-Width, 10,000 Lbs. Capacity, Two-Post Lift, Asymmetric, Screw Pad

SKU 297001 **3,199⁹⁹**
 BENXPR-10AS

- Expandable Top Beam Accommodates Wide or Narrow Drive-Thru Configuration Electric / Hydraulic Power System
- Double-Telescoping Screw Pads Offer Increased Versatility
- Padded Overhead Safety Shut-off Bar
- Exclusive Tru-Metric Arm Design For More Versatile Arm Positioning
- Height Overall: 145"
- Inside Columns: 104" - 112"
- Drop-End Arms Provide a Lower Pad Height
- Dual Hydraulic Direct-Drive Cylinders
- Oversized 53" Tall Carriage for Superior Strength and Durability
- Electric / Hydraulic Power System



Price Does Not Include Vehicles, Installation or Optional Equipment as Shown

Aligner Combo

geoliner® 550 Aligner Combo with 9,000 Lbs. Lift

SKU OUTSIDE BUY/EPO **18,299⁹⁹**
 ALIGNCOMB08

- This Combo Package Puts You in the Alignment Business with High Quality Hofmann and Bendpak Products at a Great Low Price
- The HD-9AE Four Post Alignment Lift Provides 9,000 Lbs. of Lifting Capacity to Accommodate a Variety of Light Duty Trucks and Automobiles, and the Hofmann geoliner 550 Combines Advanced Technology and Affordability to Take Your Alignment Business to the Next Level
- This Kit Includes 2 RJ-45 Rolling Jacks and an Airline Kit
- Hofmann Aligner Includes Set-up and Training



Price Does Not Include Vehicles, Installation or Optional Equipment as Shown

SAVE \$549⁹⁶

Lift Gate Service
 SKU 290017
 HOFLIFTGATE **95⁰⁰**

Available via Outside Buy/EPO,
 Call 1-877-298-6651 for ordering instructions.

ALIGNCOMB08	\$18,299.99
BENHD-9AE 9,000 Lbs. Alignment Lift	\$4,049.99
HOFEEWA717B 550 Aligner System	\$12,159.99
BENRJ-45 4,500 Lbs. Rolling Bridge Jack	\$1,194.99
BENRJ-45 4,500 Lbs. Rolling Bridge Jack	\$1,194.99
BEN5174009 Airline Kit Hd-9 Hd-14	\$249.99
TOTALS	\$18,849.95
SAVINGS	\$549.96

SEE DETAILS, PAGE 49 >>>

10,000 Lbs. Capacity Two Post Lift - Symmetric Clearfloor

SKU 296968 **3,149⁹⁹**
 BENXPR-10S

- Expandable Top Beam Accommodates Wide or Narrow Drive Thru Configuration
- Double Telescoping Screw Pads Offer Increased Versatility
- Padded Overhead Safety Shut-off Bar
- Telescoping Arm Design for More Versatile Arm Positioning
- Overall Height: 145"
- Inside Columns: 105.5" - 118.5"
- Drop End Arms Provide a Lower Pad Height
- Dual Hydraulic Direct Drive Cylinders
- Oversized 53" Tall Carriage for Superior Strength and Durability
- Electric / Hydraulic Power System



Price Does Not Include Vehicles, Installation or Optional Equipment as Shown

SEE DETAILS, PAGE 42 >>>

Power Tools

12V Max CXT™ Li-Ion 2 Piece Combo Kit (2.0Ah)

SKU 592273 **219⁹⁹**
 MAKCT230R

- Kit Includes 1/4" Hex Driver-Drill, 1/4" Impact Driver and (2) 12V Max CXT™ Batteries
- 1/4" Hex Driver-Drill with 2 Speeds (0-450 & 0-1,700 RPM) and Up to 250 In./Lbs. of Max Torque
- Impact Driver with Variable Speed (0-2,600 RPM & 0-3,500 IPM) Up to 970 In./Lbs. of Max Torque



BONUS
 12V Max CXT™ Li-Ion 2.0Ah Battery
 SKU 592260
 MAKBL1021B
 Value: \$59.99
 With Purchase of
 12V Max CXT™ Li-Ion 2 Piece Combo Kit (2.0Ah)
 SKU 592273 | MAKCT230R

Offer Good Through June 30, 2017
 While Supplies Last

SEE DETAILS, PAGE 14 >>>

Shop Cooling

20" Orbital Drum Fan

SKU 592210 **99⁹⁹**
 24882

- Pivoting Ring Surround Allows Fan to Rotate Vertically and Horizontally
- Includes Brackets for Wall Mounting
- Matte Black Metal Shroud
- 3 Aluminum Blades Produce 5100 CFM
- 3 Speed, 1.35 Amp Motor
- 6' UL Listed Power Cord
- 120V/60Hz



NEW

24" Rolling Tilt Fan

SKU 592212 **149⁹⁹**
 24880

- 4" Front Wheels for Easy Mobility
- 3 Black Aluminum Blades Produce 8600 CFM
- 3 Speed Motor
- 6' UL Listed Power Cord
- 120V/60Hz



NEW

2500 CFM 3 Speed Evaporative Cooler

SKU 592238 **399⁹⁹**
 24886

- Cools Up to 750 Square Feet for Up to 4 Hours
- 1/5 HP 3-Speed Variable Motor
- Heavy Duty Casters
- High Performance, Long-Life Cooling Pads
- Auto Fill Valve with Hose Connection
- Tool Tray Top with Cup Holders
- Air Swing Delivery for Wide Throw
- Submersible Pump with Low Water Cut Off
- Dimensions (in): 37x24x15 / Weight: 45 Lbs. / Water Capacity: 10.3 Gallons



SEE DETAILS, PAGE 21 >>>

WE'RE HERE TO HELP

DID YOU KNOW?

A BUSINESS CAN TAKE ADVANTAGE OF IRS S-179 TAX CREDITS ON EQUIPMENT PURCHASES.

CONTACT YOUR CPA FOR DETAILS.

What is the S-179 Tax Credit?

Section 179 of the IRS tax code allows businesses to deduct the full purchase price of qualifying equipment and/or software purchased or financed during the tax year. That means that if you buy (or lease) a piece of qualifying equipment, you can deduct the FULL PURCHASE PRICE from your gross income. It's an incentive created by the U.S. government to encourage businesses to buy equipment and invest in themselves. (Retrieved from http://www.section179.org/section_179_deduction.html)

PURCHASING PROGRAMS



Ask Us About Our Tool and Equipment Purchase Programs



OPTION 1 LEASING COMPANY

- Leases are Handled by Three Companies



Financing you can trust.™



UniSource Capital

Never give up...Never Surrender!®

- Customer Must:**
 - Select Equipment
 - Complete Credit Application
 - Receive Approval From Leasing Company
- Once the Transaction is Approved**
 - PO Issued
 - Tool Ordered



OPTION 2 30-60-90

- ✓ AutoZone® Credit Account in Existence for 6 Months
- ✓ Updated Credit Application with Agreement Section Completed and Signed
- ✓ No NSF Checks
- ✓ No Credit Holds 6 Months
- ✓ Credit Worthiness
- ✓ Minimum Equipment Cost
 - \$1K (Tax Must Be Included)
- ✓ 25% Minimum Down Payment
- ✓ 52 Week Sales Amount \$15K



OPTION 3 EXTENDED TERMS

- ✓ 3 Years in Business (Credit Bureau Reporting)
- ✓ Updated Credit Application with Agreement Section Completed and Signed
- ✓ No NSF Checks for 1 Year
- ✓ 1 Year Satisfactory Payment History with AutoZone®
- ✓ Credit Worthiness
- ✓ Minimum Equipment Cost by Term
 - 6 Months \$3K
 - 9 Months \$6K
 - 12 Months \$8K or greater
- ✓ 25% Minimum Down Payment
- ✓ Financial Statement
- ✓ 52 Week Sales Amount \$25K

Financing is provided by third parties who are not affiliates of AutoZone. All of the advertised loan programs, rates, terms and conditions are subject to change at any time without notice. An extra charge may be imposed at the end of the lease depending on the residual value of the leased goods.

CUSTOMER SERVICE



Our Customer Service Associates Have Over 100 Years of Combined Experience in the Tool and Equipment Industry.

You can be sure they are ready to answer your questions and give you the support you need to manage your business and keep your customers satisfied.



We want your purchasing experience to be the best and to ensure you are satisfied. As our customer, you can expect fast, personalized and professional service.

For All of Your Tool, Equipment and Shop Supply Needs, Call **1-877-AZTOOL1 (1-877-298-6651)** or Email Us at **AZTOOL@AZTOOL1.com**. (Hablamos Español)

Call Center Hours: Monday - Friday 7:00 a.m. to 5:00 p.m. CT

Guiding You to the Right Products at the Right Price:

"What is the Right Tire Changer for My Shop?"

Call 1-877-AZTool1

"I'm Looking for a Specific Item That's Not in This Flyer."

Call 1-877-AZTool1

"Can You Track Down My Order?"

Call 1-877-AZTool1

"I'm Interested in Leasing Some Equipment."

Call 1-877-AZTool1

"I Need My 4 Post Lift Repaired."

Call 1-877-AZTool1

"I HAVE A PROBLEM!!!"

Call 1-877-AZTool1

AutoZone®

Tool & Equipment QUARTERLY

AutoZone Tool & Equipment Offers the Best Brands in the Business.



Shop This Flyer or Call:

1-877-AZTool1
1-877-298-6651
(Hablamos Español)

TOOLS AND EQUIPMENT IN THIS ISSUE:

Abrasive Blasting..... 25	Exhaust Tools..... 98	Power Tool Accessories..... 19
A/C Service..... 26-34	Extractor Sets..... 99	Pressure Washers..... 23-24
Air Compressors..... 75-77	Fan Clutch Tools..... 92	Pullers..... 35, 63, 94, 96
Air Filters, Drains, Regulators..... 77	Fans, Evaporative Coolers, Heaters..... 21-22, 24	Recovery Machines..... 28-29, 34
Air Hoses/Reels..... 81-82	Fender Covers..... 114	Rivet Tools..... 101
Air Tools and Accessories..... 80-82	Flashlights..... 85-87	Safety..... 111, 113, 118
Alignment..... 48-51, 53	Floor Jacks..... 54, 58	Scan Tools..... 20, 68-70
Axle Tools..... 94-95	Floor Mats, Seat Covers..... 114	Screwdrivers..... 104, 107
Battery Chargers..... 89-90	Fluid Evacuators-Dispensers..... 65-66	Service Carts..... 8, 11-13
Battery Service..... 88-91, 103	Fuel Injection..... 71	Shop Heaters..... 24
Bearing Packer..... 65	Generators..... 23, 77	Shop Presses..... 56
Bearing Tools..... 35, 56, 65, 93-96	Gloves..... 111-113	Shop Supplies..... 114-117, 118
Belt Tools..... 92	Grease Guns..... 65	Smoke Machines..... 71
Blow Guns..... 81-82	Hammers..... 79, 108	Soldering Kits..... 27
Body Tools..... 63	Hand Cleaner..... 118	Spark Plug Thread Repair..... 99
Booster Packs..... 88-90	Hand Tools..... 104, 106-109	Spring Compressors..... 34, 93-94
Borescopes..... 69-70	Hardware Kits, Fuses, Washers, O-Rings..... 115	Stools..... 115
Bottle Jacks..... 54, 58	Headlight Bulbs..... 118-119	Surface Prep Tools and Accessories..... 74, 79-80
Brake Lathes..... 60-61	Heat Shrink Tube Sets..... 26, 115	Thermometers..... 30
Brake Service Tools..... 61-62	Hole Saw Kits..... 19	Thread Repair..... 98-99
Chassis/Suspension..... 94-95	Hood Props..... 63	Timing Lights..... 72
Circuit Testers and Probes..... 72, 100	Hose Clamp Tools..... 66	Tire Changers..... 20, 36-38, 47-48, 53
Compression, Oil Pressure, Fuel Pressure and Back Pressure Gauge Kits..... 71	Impact Wrenches..... 14, 16-18, 74, 78, 82, 91	Tire Service..... 36-41
Fluid Handling..... 67	Jack Stands..... 55, 58	Tool Sets..... 12, 106-107, 109
Cooling System Adapters..... 67	Jump Starters..... 88-90	Tool Storage..... 8-13, 105
Cooling System Tools..... 66-67	Leak Detection..... 32	Torque Wrenches..... 97
Cordless Drills, Impacts..... 14-18, 74	Lifts..... 20, 42-50, 52	TPMS..... 40
Crankshaft Tools..... 93	Lighting..... 15, 17, 84-87	Transmission Jacks..... 55, 58
Creepers..... 115	Lockout Tools..... 101	Tube Benders and Tools..... 26
Cylinder Hones..... 92	Manifold Gauges..... 31	Uniforms..... 110
Diagnostic..... 68-73	Measuring Tools..... 97	UV Leak Detection..... 32
Disconnect Tools..... 66, 102	Multimeters..... 72	Vacuums..... 24
Drain Pans..... 64	Oil Drains and Accessories..... 64-65	Vacuum Pumps..... 29-30, 96
Drill Bits..... 19, 99	Oil Filter Wrenches..... 64	Vises..... 25
Duralast Hand Tools..... 104	Paint and Body..... 63	Welding, Cutting..... 26
Engine Lifts and Stands..... 56	Parts Washers..... 25	Wheel Balancers..... 20, 36, 39, 48, 53
Engine Service..... 92-93	Pick-Up Tools..... 109	Wheel Weights..... 41
Exhaust Hoses..... 24	Probe Kits..... 72	Wire Strippers and Crimpers..... 100
		Wrenches..... 64, 92, 97, 104, 106, 109

BRANDS IN THIS ISSUE:

Airsept..... 29, 31, 33, 102	Generac..... 23-24	Powerbuilt..... 101
AllData..... 83	Goodyear..... 81	Power Probe..... 72
Ammco..... 60	GreatLite..... 85-87	Pro-Cut..... 61
Arrow Pneumatics..... 77	GreatNeck..... 18, 107-109, 115	Puma..... 77
Associated..... 89	Grip-On..... 13	QSP..... 51
ATEQ..... 40	Hardware Machinery..... 26	Ranger..... 20, 36-39, 45, 55-56, 60, 81
Atlas..... 52	HECAT..... 67	Rapidair..... 81
Autel..... 20, 40, 62, 68-70	Hein-Werner..... 54-55	Realtree..... 116
BADA..... 41	Hessaire..... 21	Redline..... 66, 71
Bartec..... 40	Hofmann..... 20, 36-37, 39, 49-51, 60	Robinair..... 29, 34
Baseline..... 38, 39	Ingersoll Rand..... 76, 78-79, 81	Rotary..... 42, 50
Bendpak..... 20, 26, 42-45, 49-50	Innova..... 70, 72	SAS Safety..... 111, 113
Blackhawk..... 54-55	John Dow..... 40, 55, 94	Schrade..... 98
Branick..... 94	Knipex..... 106, 109	Schumacher..... 90
Smart-O..... 65	KTool..... 59	Shark..... 19, 25-26, 60-61, 80
BRM..... 61-62, 92	Kubota..... 24	Shop Iron..... 27
Cal-Van..... 66, 93, 99, 102	Launch..... 73	Slip-N-Grip..... 114
CanDo..... 20, 69, 72	Lincoln..... 25, 64-65	Smith & Wesson..... 98
CEMB..... 53	Lisle..... 13, 41, 62-65, 72, 92-102, 113	Steck..... 13, 63, 95, 101
Central Tools..... 87, 97	M7..... 78	Streamlight..... 85
Challenger..... 20, 42-45, 50	Mahle..... 28-29, 67, 70	Sure Shot..... 62
Champion..... 23, 27	Makita..... 14-15, 19	Sylvania..... 118
Chicago Pneumatic..... 76	Marson..... 101	Symtech..... 67
Cleanmaster..... 25	Mastercool..... 28-33, 98	The Main Resource..... 38
Coast..... 85-86	Mechanix Wear..... 111	Thermal Dynamics..... 26
Coats..... 20, 36, 38-39	Medline..... 112	Thexton..... 31, 41, 57, 72, 96
Cool Space..... 22	Microflex..... 112	Torin..... 58
CPS..... 28-30	Midtronics..... 89	Tracer Products..... 32
Crushproof Tubing Company..... 24	Mighty Lift..... 116	Trusty-Cook Inc..... 108
Dannmar..... 36, 42-45, 48, 50-51	Milton..... 80-81	Tuxedo..... 46-47
Deka..... 91	Mi-T-M..... 23, 77	UEI..... 72
DeWALT..... 16-17, 19	Mityvac..... 62, 65, 71, 96	Vaper..... 82
Dickies..... 110	Montezuma..... 8	Water Works..... 25
Ditch Pig..... 116	National Oak Distributors..... 117	
Dorman..... 27	NES..... 98-99	
Drew Technologies..... 72	Noregon..... 20	
Duralast..... 56, 63, 79-80, 103-104, 107-108, 114	OEMTOOLS..... 8-13, 18, 21, 25-27, 29-33, 40-41, 51, 54-57, 61-67, 69-72, 74-81, 84, 86-89, 91-102, 105-109, 111, 114-116	
EIKO..... 119	Omega..... 43, 54-57, 115	
ES..... 69, 72, 100	OTC..... 34-35	
Energy Logic..... 22, 24	Panther Vision..... 118	
Ernst Mfg..... 13	Parts Brush Div..... 25	
Firepower..... 26	Performance Tech..... 95, 102	
Fix-A-Thred..... 99	Performance Tool..... 72	
Forward..... 42-45, 50	Phoenix Systems..... 61	
Fountain..... 25	Portacool..... 22	
Fowler..... 97	Porto Power..... 57	
G&G Technics..... 95-96		



NEW ARRIVALS

Air Compressors

INDUSTRIAL GRADE COMPRESSORS

All Compressors Include:

- Bonus Start-Up Kit
- Full Two Year Warranty
- Nationwide Service Network
- ASME Tank and Safety Valves
- High-Flow Belt Guard



5HP 60 Gallon Single Phase 230V Compressor
SKU 592262 26106 **1,099⁹⁹**

- 15.3 CFM at 100 PSI, 165 PSI Max Pressure
- Thermally Protected Motor
- High Flow Belt Guard
- Aluminum Head and Coolers for Better Heat Dissipation
- No Magnetic Starter Required

Lift Gate Service
SKU 295540
OEMLIFTGATE **80⁰⁰**

Ready To Ship
IN STOCK



5HP 80 Gallon Single Phase 230V Compressor
SKU 592257 26100 **1,699⁹⁹**

- 18 CFM at 100 PSI, 175 PSI Max Pressure
- Heavy Duty, Low RPM Cast Iron Pump
- Magnetic Starter Mounted and Wired
- High Flow Belt Guard



13HP 30 Gallon Honda Gas Powered Compressor
SKU 592266 26105 **2,399⁹⁹**

- 23 CFM at 100 PSI, 175 PSI Max Pressure
- Heavy Duty, Low RPM Cast Iron Pump
- Magnetic Starter Mounted and Wired
- Electric and Recoil Start
- High Flow Belt Guard

AIR COMPRESSORS 75

Diagnostic

Intake Inflatable Block Off Bladder for Use with All Smoke Machines

SKU 598274 24536 **99⁹⁹**

- Can Be Used with Any Brand of Smoke Machine or Diagnostic Leak Detector
- Conforms to Any Shape Intake / Exhaust: Square, Round, Oval or Rectangular
- Can Be Used with Any Brand of Smoke Machine or Diagnostic Leak Detector
- Works with Most Automobiles and Light, Medium, and Heavy-Duty Trucks



Heavy Duty MaxiSYS[®] Diagnostic Tablet

SKU 596888 AULMS908CV **4,694⁹⁹**

- Performs Enhanced System Diagnostics on More Than 60 Commercial Vehicles
- 9.7" LED Capacitive Touch Screen, Android-Based Tablet
- MaxiFlash Elite, Bluetooth-Enabled VCI/ J2534 Device
- WiFi and Bluetooth-Enabled Tablet
- Read and Clear Codes, View and Graph Live Data
- Perform Tool-Guided Maintenance Services
- Diagnoses Manufacturer-Specific Systems Including Allison Transmissions, Bendix ABS Brake Systems, and Detroit Diesel Engines
- One-Year Software Updates



DIAGNOSTIC 68-73

Air Tools

1/2" Drive Impact Wrench

SKU 592249 KNGNC-4232Q **189⁹⁹**

- Mighty Small, Mighty Powerful Air Impact Wrench
- 700 Ft./Lbs. Max Reverse Torque
- 85 dBA Noise Level Bests OSHA Standards
- Ultra Lightweight at Less Than 3 Pounds
- Twin Hammer Mechanism



3/4" Drive Composite Impact Wrench

SKU 592352 KNGNC-6255Q **279⁹⁹**

- One of the Lightest and Most Powerful 3/4" Drive Guns
- 1400 Ft./Lbs. of Max Reverse Torque
- 85 dBA Noise Level Bests OSHA Standards
- Ultra-Light 4.2 Pounds
- Twin Hammer Mechanism



AIR TOOLS 78-79

Power Tools

Cut-Off Tool

SKU 596951 DWTDWMT70784 **59⁹⁹**

- Ergonomically Designed Cushion Grip for Improved Comfort and Tool Control
- Touch Control Trigger Allows User to Apply Needed Amount of Power
- Aluminum Body Design
- Safety Throttle Lever
- Rear Air Exhaust



12V Max Li-Ion 3/8" Driver-Drill (Tool Only)

SKU 592328 MAKFD02ZW **79⁹⁹**

- Delivers 200 In./Lbs. of Max Torque
- Variable 2-Speed Design (0-350 and 0-1,300 RPM)
- Weighs Only 2.2 Lbs. with Battery (Not Included)
- Ergonomic Shape



18V LXT[®] Li-Ion Sub-Compact Brushless 1/2" Driver-Drill (Tool Only)

SKU 592347 MAKXFD11ZB **129⁹⁹**

- Compact and Ergonomic Design at Only 6-3/8" Long
- Ergonomically Designed Handle with Rubberized Soft Grip
- Mechanical Variable 2-Speed Transmission (0-500 and 0-1,700 RPM)
- Weighs Only 2.8 Lbs. with Battery (Not Included)
- Tool Only



18V LXT[®] Li-Ion Compact 2 Piece Combo Kit

SKU 592293 MAKXT272R **379⁹⁹**

- Variable Speed Impact Driver (0-2,900 RPM and 0-3,500 IPM) Delivers 1,460 In./Lbs. of Torque
- Impact Driver is Only 5-3/8" Long, Weighing 3.9 Lbs. with Battery
- Variable Speed Impact Wrench (0-2,100 RPM and 0-3,200 IPM) Delivers 155 Ft./Lbs. of Max Torque



Offer Good Through June 30, 2017 While Supplies Last

BONUS

18V Li-Ion 2.0 Ah Battery
SKU 849432 MAKBL1820B
Value: \$99.99
With Purchase of:
18V LXT[®] Li-Ion Compact 2 Piece Combo Kit
SKU 592293 | MAKXT272R

POWER TOOLS 14-18

Service Tools



Harmonic Balancer Remover

- SKU 596957 GGT180 **149⁹⁹**
- Time Saving Harmonic Balancer Puller
 - Clip-in Compact Design (No Bolts Required)
 - Suitable for: GM, 5.3L, 5.7LS1, 6.0LS2, 6.2LS3, 7.0L
 - Also Fits: Chrysler/Dodge/Jeep 3.5L & 3.6L V6s and 4.7L, 5.7L, and 6.1L V8s
 - Radiator Removal Not Required



Bubble Flaring Tool Kit

- SKU 592261 27214 **39⁹⁹**
- Designed for Metric Soft Steel Brake Lines Where an "ISO" or Bubble Style Flare is Required
 - Flaring Bar and All the Adapters Needed For ISO Bubble Flaring
 - Includes Four Dies 4.75, 6, 8, and 10 mm

SERVICE TOOLS 96-98

Engine Service Tools

Ford Cam Phaser Noise Kit 4.6/5.4 3V with Tuning

SKU 597001 24209 **799⁹⁹**

- Includes Performance Tuning Optimized for This Kit to Produce Max Horsepower and Torque
- This Kit Also Includes Tuning Options for Airflow, TPMS, Top Speed Limit, Speed of Calibration, Rev Limiter, Shift Firmness, Shift Point, Cooling Fan On/Off Temp
- Note: Not All Features are Available in All Applications the Year, Make, and Model of the Vehicle Will Determine the Feature Set for That Application.
- Cam Phaser is NOT INCLUDED



ENGINE SERVICE TOOLS 92-93

Shop Cooling and Air Fans

20" Orbital Drum Fan

- SKU 592210 24882 **99⁹⁹**
- Pivoting Ring Surround Allows Fan to Rotate Vertically and Horizontally
 - Includes Brackets for Wall Mounting
 - Matte Black Metal Shroud
 - 3 Aluminum Blades Produce 5100 CFM
 - 3 Speed, 1.35 Amp Motor
 - 6' UL Listed Power Cord
 - 120V/60Hz



24" Rolling Tilt Fan

- SKU 592212 24880 **149⁹⁹**
- 4" Front Wheels for Easy Mobility
 - 3 Black Aluminum Blades Produce 8600 CFM
 - 3 Speed Motor
 - 6' UL Listed Power Cord
 - 120V/60Hz



30" Internal Orbit Wall Mount Fan

- SKU 592385 24884 **179⁹⁹**
- Easily Assembled and Wall-Mounted
 - Oscillates 180 Degrees, Spreading Airflow throughout Workspace
 - (3) Aluminum Blades and High Efficiency Motor Produce 9,500 CFM
 - 3 Speed (2.4 A) Motor Allows Operator to Control Airflow Volume
 - 6' UL Listed Power Cord

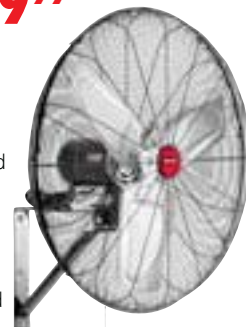

30" Oscillating Pedestal Fan

- SKU 592248 24885 **199⁹⁹**
- Complete Metal Structure with Large Base
 - Oscillates 180 Degrees
 - 3 Aluminum Blades Produce 9500 CFM
 - 3 Speed, 2.4 Amp Motor
 - 6' UL Listed Power Cord
 - 120V/60Hz



SHOP COOLING 21-22

Chassis/Suspension

Hydraulic Ball Joint Separator

- SKU 596905 GGT850 **99⁹⁹**
- Quick, Easy Ball Joint Separation
 - 8 Ton Hydraulic Ram
 - Jaw Opening Capacity: 56mm (2.25")
 - Jaw Width: 22mm (0.86")
 - No More Hammering Suspension Arms



CHASSIS-SUSPENSION 94-95

Shop Supplies

Magnetic Nut Cups, 2 Pack

- SKU 592211 25115 **29⁹⁹**
- No More Crawling Around on the Ground Looking for a Fallen Fastener or Nut
- Magnetic Cups Hold Nuts, Bolts, Parts and Screws Securely Until You Need Them
 - Strong Magnets Attach the Cups Securely to Flat Metal Surfaces
 - Matching Magnetic Cups Come in a Pair and Are Shipped in a Handsome Display Box



The Torch - 10 Oz. Copper Lowballs, Boxed Set of 4

- SKU 527867 26015 **59⁹⁹** REG. \$69.99
- Includes (4) 10 Oz. Copper Colored Lowballs
 - The Perfect Size for Your Morning Coffee or Evening Toddy
 - This Lowball Fits Easily in Your Hand
 - Comes with Replaceable Shatter-Proof Lid
 - Made with Durable Kitchen-Grade 18/8 Stainless Steel
 - Finished in a Copper Colored Coating
 - No Sweat Design Keeps Fingers Dry and Comfortable
 - Double-wall Vacuum Insulation Keeps Drinks Cold or Hot to the Last Sip
 - Keeps Ice 2x Longer than Plastic Tumblers
 - Comes in a Decorative Storage Box, Ready to Gift



SAVE \$10

Offer Good Through June 30, 2017 While Supplies Last

SHOP SUPPLIES 114-119

Hot Water Pressure Washers

HSE 1500 PSI 2.0 GPM

- SKU 597218 MTMHSE15020MM **2,799⁹⁹**
- Features a Top-Fired Heat Exchanger and Totally Enclosed, Fan-Cooled Electric Motor
 - Pump Features a High Pressure Detergent Injector
 - Temperature Rise: 150°F (66°C); Max Outlet Temperature: 200°F
 - Unit Includes: (4) Quick Connect Nozzles, 50' x 3/8" Wire-Braided High Pressure Hose, Insulated Trigger Gun with Safety Lock-Off and Adjustable Pressure Insulated Dual Lance
 - 35-Foot Power Cord
 - CSA Certified - US and Canada



HSP 3500 PSI 3.3 GPM

- SKU 597220 MTMHSP35043MH **4,299⁹⁹**
- Burner Utilizes a Patented Electro Magnetic Firing (EMF) System, Eliminating the Need for a 12V Battery
 - Pump Features a Low Pressure Detergent Injector
 - Temperature Rise: 150°F (66°C); Max Outlet Temperature: 200°F
 - Unit Includes: (4) Quick Connect Nozzles, 50' x 3/8" Wire-Braided High Pressure Hose, Insulated Trigger Gun with Safety Lock-Off and Adjustable Pressure Insulated Dual Lance
 - CSA Certified - US and Canada



FOR DETAILS SEE PAGE 23

Lighting

Multi-Use Rechargeable Diagnostic Work Light

- SKU 591153 24609 **109⁹⁹**
- 3 Different Light Modes - White, Yellow (Smoke Detection), UV/Black (Leak Die Detection)
 - 400 Lumens of Super Bright Light Lasts Over 5 Hours Using White Light
 - Holds Charge for a Longer Runtime with 4400 mAh Li-Ion Battery

Must Have Mechanic's Tool



400 LUMENS

MAX RUN TIME 5hrs

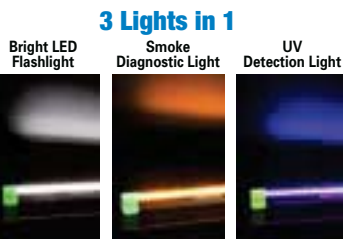

TOOL of the MONTH JUNE SEE INSERT FOR DETAILS

CREE LED Pen Light

- SKU 592184 32835 (Black) **19⁹⁹**
- Comes with (2) AAA Panasonic® Batteries and Tactical Clip
 - 3 Modes: Low (50 Lumens), High (150 Lumens) and Strobe
 - Battery Runtime: 6 Hours (Low), 3 Hours (High)
 - 80 Meter Beam Distance
 - Anodized Aluminum Body is Impact and Water Resistant
 - Dimensions: 5.7" (L) x 0.6" (D)
 - Weight: 1.6 Oz.

Impact and Water Resistant



150 LUMENS

MAX RUN TIME 3hrs

GreatLite

Rechargeable Pen Light with Focus

- SKU 592181 32830 (Black) **49⁹⁹**
- Rotating Focus System and Magnetic Base
 - 2 Modes: Low (50 Lumens) and High (100 Lumens)
 - Battery Runtime: 5 Hours (Low), 2.5 Hours (High)
 - Anodized Aluminum Body is Impact Resistant to 1 Meter
 - Charging Indicator Lights: Charging (Red) and Fully Charged (Green)
 - 80 Meter Beam Distance
 - Weight: 3.2 Oz.
 - Dimensions: 5.875" x 0.75"

Rechargeable Battery

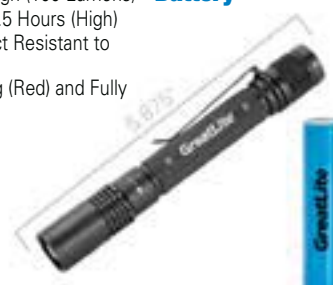

100 LUMENS

MAX RUN TIME 2.5hrs

GreatLite

- (Blue) SKU 592185 32836 (Red) SKU 592188 32838 (Green) SKU 592186 32837 (Silver) SKU 592183 32839

- (Blue) SKU 592177 32831 (Green) SKU 592178 32832 (Red) SKU 592179 32833 (Silver) SKU 592182 32834

LIGHTING 84-87

Tire Service

Tire Taxi

- SKU 597221 DOWJDITTI **109⁹⁹**
- Designed to Transport Car, Light Truck and SUV Tires and Wheels
 - Efficiently Transport Tires from Storage Areas to Service Bays
 - May be Used for Display Purposes
 - (4) Heavy-Duty 3" Casters (One Locking Caster Included) Allow Effortless Movement and 360 Degree Rotation
 - Capacity: (5) Tire and Wheel Assemblies or (8) Tires (265 Lbs.)



TIRE SERVICE 36-41

Shop Supplies

SHOP SUPPLY of the MONTH MAY SEE INSERT FOR DETAILS

3 Pack of LED Lighted Safety Glasses

- SKU 592265 26017PK3 **29⁹⁹**
- High-Impact Polycarbonate Lenses
 - Soft Thermoplastic Rubber Arm Ends Provide Added Comfort
 - 100% UV Protection
 - ANSI Z87.1 Standards
 - Hi-Visibility Green for Easy Finding
 - Batteries Included



SHOP SUPPLIES 114-119

QUARTERLY SPECIALS

Combo Price: \$699.99
 4 Drawer Top Chest: \$399.99
 6 Drawer Cabinet: \$499.99
 Total: \$899.98
SAVINGS: \$199.99

SAVE \$199⁹⁹ ON COMBO PURCHASES

SAVE \$199⁹⁹

Combo Price: \$899.99
 6 Drawer Top Chest: \$499.99
 10 Drawer Cabinet: \$599.99
 Total: \$1,099.98
SAVINGS: \$199.99

OEM TOOLS

SEE DETAILS, PAGE 9 >>>

36" 10 Drawer Chest and Cabinet Combo Black/Green

SKU OUTSIDE BUY/EPO 24593

699⁹⁹ REG. \$799.99

- Dimensions: 36.7" x 18.1" x 61" (W x D x H)

Lift Gate Service
 SKU 295540
 OEMLIFTGATE **80⁰⁰**

Available via Outside Buy/EPO,
 Call 1-877-298-6651 for ordering instructions.

Offer Good Through June 30, 2017 - While Supplies Last



Features:

- Raise and Release Drawer Latches to Secure Drawers
- EVA Drawer Liners Included
- Gas Struts for Easy Opening



Flat Key Locking System



4 Large Sturdy 5" x 2" Mag Casters 2 Locking



Full Extension 100 Lbs. Capacity Slides



Molded Side Handles

41" 16 Drawer Chest and Cabinet Combo Black/Green

SKU OUTSIDE BUY/EPO 24596

899⁹⁹ REG. \$999.99

- Dimensions: 41" x 18.1" x 61" (W x D x H)

Lift Gate Service
 SKU 295540
 OEMLIFTGATE **80⁰⁰**

Available via Outside Buy/EPO,
 Call 1-877-298-6651 for ordering instructions.

Offer Good Through June 30, 2017 - While Supplies Last



OEM TOOLS SEE DETAILS, PAGE 88 >>>

PPS-X
 WITH SMART JUMP CABLES

LI/18000 mAh

SAVE \$60

PPS-X Li-Ion Jump Starter and Power Bank with "Smart Jump Cables"

SKU 568481 24455 **139⁹⁹** REG. \$199.99

- TSA Checkpoint Friendly Power Bank is Great for Traveling on Planes
- Two (2) 2A USB Output Ports for Charging Electronic Devices
- 19V-3.5A Output with Universal AC/DC Adapters Will Power Most Laptops



Offer Good Through June 30, 2017 While Supplies Last



Charge Your Phone, Tablet or Laptop



Holds Charge Up to 12 Months without Recharging



Intelligent Cables That Verify Proper Connection, Making Jump Starting Easy and Safe



Jump Start a V8 Engine

OEM TOOLS SEE DETAILS, PAGE 71 >>>

Fuel Pressure Test Kit

SKU 347235 27265 **109⁹⁹** REG. \$159.99

- Designed Around Quick Connect Adapters
- Includes 3-1/2" Heavy Duty Gauge with Protective Boot, Large and Small Schrader Adapters, M6-1.00 Banjo Adapter, Double End Tee for 5/16" and 3/8" and Single End Connector for 1/4", 5/16" and 3/8"
- Range: 0 - 150 PSI
- Comes in a Blow Mold Case



SAVE \$50

Offer Good Through June 30, 2017 - While Supplies Last

OEM TOOLS SEE DETAILS, PAGE 97 >>>

3/4" Drive Torque Multiplier

SKU 191056 25683 **249⁹⁹** REG. \$299.99

- Converts Low Torque (Max. 650 Ft./Lbs.) to High Torque (2,200 Ft./Lbs. / 3,000 Nm) with Planetary Gear Set for Heavy Duty Tightening and Loosening
- Input Drive: 3/4", Output Drive 1"
- Comes with a 3/4" Drive 2 Way Quick Release Ratchet



Offer Good Through June 30, 2017 - While Supplies Last

SAVE \$50

OEM TOOLS SEE DETAILS, PAGE 97 >>>

1/2" Drive Professional Micrometer Adjustable Torque Wrench

SKU 133659 25687 **69⁹⁹** REG. 79.99

- Heavy Duty 24 Tooth Pear Shaped Ratchet Head
- Audible Click When Desired Torque is Reached
- Both Clockwise and Counter Clockwise Operation



Heavy Duty Head

Offer Good Through June 30, 2017 - While Supplies Last

SAVE \$10

OEM TOOLS SEE DETAILS, PAGE 25 >>>

4" Heavy Duty Bench Vise with Swivel Base

SKU 751643 24217 **49⁹⁹** REG. \$69.99

- Machined Replaceable Steel Jaws
- Machined Anvil, Permanent Pipe Jaws
- Full 360° Swivel Base
- Clamping Strength: 200 Lbs.



Offer Good Through June 30, 2017 - While Supplies Last

SAVE \$20

OEM TOOLS SEE DETAILS, PAGE 94 >>>

Master Wheel Hub and Bearing Remover and Installer Kit

SKU 298230 27213 **399⁹⁹** REG. \$449.99

- For Removal and Installation of Front Wheel Hub and Bearings on Asian, Domestic and German Vehicles along with Rear Wheel Hubs and Bearings on European Vehicles
- Works on Front, Rear and All-Wheel Drive Vehicles
- Self Centering Design is Incredibly Durable and Easy to Use



Offer Good Through June 30, 2017 - While Supplies Last

SAVE \$50

OEM TOOLS SEE DETAILS, PAGE 107 >>>

64 Piece 1/4" Drive Mechanic's Set in EVA Foam Tray

SKU 020788 23997 **159⁹⁹** REG. \$199.99

- Shallow Sockets, 6 Pt: 4, 4.5, 5, 5.5, 6, 7, 8, 9, 10, 11, 12, 13, 14 and 15 mm
- 1/4" Dr. Deep Sockets, 6 Pt: 4, 4.5, 5, 5.5, 6, 7, 8, 9, 10, 11, 12, 13, 14 and 15 mm
- 1/4" Dr. Wobble Straight Extension
- 1/4" x 1/4" Extension
- Bit Extension Bars: 6" and 10"



EVA Trays Feature a Hard Top Carbon Fiber Style Finish That Makes for a Lifetime Lasting Tray

SAVE \$40

Each Tool Size is Marked for Fast Identification

Offer Good Through June 30, 2017 - While Supplies Last

OEM TOOLS SEE DETAILS, PAGE 107 >>>

31 Piece 3/8" Drive Mechanic's Set in EVA Foam Tray

SKU 802210 23998 **119⁹⁹** REG. \$149.99

- Magnetic Spark Plugs
- Featuring 36 Teeth Sealed Head 3/8" Ratchet
- Shallow Sockets, 6-Pt: 8, 9, 10, 11, 12, 13, 14, 15, 16, 17, 18 and 19 mm
- 3/8" Dr. Deep Sockets, 6-Pt: 8, 9, 10, 11, 12, 13, 14, 15, 16, 17, 18 and 19 mm
- 3/8" Wobble Extensions: 3", 6" and 12"
- 3/8" Universal Joint
- 3/8" Spark Plugs: 5/8" and 9/16"



Offer Good Through June 30, 2017 While Supplies Last

SAVE \$30

OEM TOOLS SEE DETAILS, PAGE 114 >>>

Adjustable Tire Step

SKU 818571 24913 **24⁹⁹** REG. \$34.99

- Fits Both Front and Rear 9" to 13" Wide Tires
- Powder Coat Finish
- Designed for SUVs, Motor Homes and Light-Duty Trucks
- Heavily Textured Non-Slip Step for Safety
- Adjustable Rubber Bumpers Protect Your Wheels and Ensure the Step is Sturdy and Level
- Easy to Adjust
- Weight Capacity: 300 Lbs.



Offer Good Through June 30, 2017 - While Supplies Last

SAVE \$10

OEM TOOLS SEE DETAILS, PAGE 93 >>>

Honda Crankshaft Pulley Holding Tool

SKU 217379 27176 **29⁹⁹** REG. \$39.99

- Holds Crankshaft Dampeners When Tightening/Loosening Crankshaft Bolts on Honda and Acura Engines 1990 to Present



Offer Good Through June 30, 2017 - While Supplies Last

SAVE \$10

OEM TOOLS SEE DETAILS, PAGE 93 >>>

Crankshaft and Camshaft Seal Kit

SKU 512952 27222 **129⁹⁹** REG. \$149.99

- Install and Remove Oil Seals Between 27 mm and 58 mm in Diameter

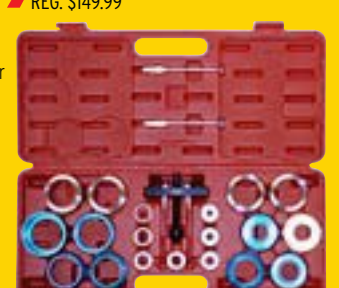

Offer Good Through June 30, 2017 - While Supplies Last

SAVE \$20

Offers Good April 1 - June 30, 2017

OEM TOOLS SEE DETAILS, PAGE 55 >>>

800 Lbs. Low Profile Transmission Jack

SKU 544789 24843 **299⁹⁹** REG. \$349.99

- Lift Range: 8-1/4" to 30-1/2"
- Fully Adjustable Saddle Adapts to Most Transmission Pans
- Swivel Saddle Adjusts Both Directions
- (4) Swivel Ball Bearing Casters for Ease of Mobility



Lift Range: 8-1/4" to 30-1/2"

SAVE \$50

Offer Good Through June 30, 2017 - While Supplies Last

OEM TOOLS SEE DETAILS, PAGE 72 >>>

Multi-Function Power/Ground Meter

SKU 300126 24366 **79⁹⁹** REG. \$149.99

- Quickly Diagnose Circuits and Test Components
- Apply Battery Voltage or Ground with a Simple Thumb Rocker Switch
- Performs Standard Multimeter Functions: Volt, Continuity and Polarity
- Includes: Meter, 20' Extension Lead, Probe Extension, Battery Clips, Cigarette Lighter Adapter, Auxiliary Ground Lead

MEASURE SPARK KV, INJECTOR FREQUENCY AND PULSE



SAVE \$70

Offer Good Through June 30, 2017 - While Supplies Last

OEM TOOLS SEE DETAILS, PAGE 78 >>>

1/2" Drive Composite Impact Wrench

SKU 347258 24400 **199⁹⁹** REG. \$299.99

- Max. Torque: 900 Ft./Lbs.
- Air Consumption: 5.1 CFM
- Air Inlet Thread: 3/8"
- Weight: 4.58 Lbs.
- Sound Level: 96.2 dBA



Comes with 3/8" to 1/4" Adapter

Air Consumption 5.1 CFM

SAVE \$100

Offer Good Through June 30, 2017 - While Supplies Last

OEM TOOLS SEE DETAILS, PAGE 56 >>>

1 Ton Folding Engine Stand

SKU 544804 24834 **199⁹⁹** REG. \$249.99

- Folds Upright to Conserve Valuable Floor Space
- Sturdy, Wide Base Design to Prevent Tipping Under Load
- Slotted Adjustable Saddle Permits Quick and Easy Installation
- Head Swivels 360° to Easily Position Engine



6 Wheel Design Provides Maximum Stability

SAVE \$50

Offer Good Through June 30, 2017 - While Supplies Last

OEM TOOLS SEE DETAILS, PAGE 79 >>>

1/4" Drive Super Duty Air Impact Ratchet

SKU 850508 24415 **159⁹⁹** REG. \$179.99

- Max Torque: 50 Ft./Lbs.
- Free Speed: 700 RPM
- CFM: 3.1 @ 90 PSI
- Length: 6.5"
- Sealed Head Ratchet Housing Prolongs Tool Life
- Compact and Lightweight
- Most Power to Weight Ratio
- Rear Air Exhaust: 360° Adjustable



Impact Mechanism Adds Power and Prevents Kickback

SAVE \$20

Offer Good Through June 30, 2017 - While Supplies Last

OEM TOOLS SEE DETAILS, PAGE 40 >>>

Digital Air Tire Inflator

SKU 802198 24412 **49⁹⁹** REG. \$59.99

- Easy-to-Read Backlit LCD Display
- Four Units of Measure (PSI, Bar, KPa, kgf)
- Measuring Range: 0 - 175 PSI (0 - 12 Bar)
- Accuracy: +/-1.2 PSI Up to 58 PSI, +/-2.3 Between 58 PSI and 145 PSI Inclusive, +/-3.6 PSI Greater Than 145 PSI
- High Air Flow Saves the Technician Time



SAVE \$10

Offer Good Through June 30, 2017 - While Supplies Last

OEM TOOLS SEE DETAILS, PAGE 78 >>>

Heavy Duty 1/2" Composite Stubby Impact Wrench

SKU 087596 24418 **169⁹⁹** REG. \$199.99

- 1/2" Square Composite Air Impact Delivering 900 Lbs. of Torque
- Air Consumption: 4.0 CFM
- Includes (7) 1/2" Short Impact Sockets Sizes 13 mm-19 mm
- Custom Cut EVA Foam for Storage Tray



SAVE \$30

Offer Good Through June 30, 2017 - While Supplies Last

OEM TOOLS SEE DETAILS, PAGE 78 >>>

Mighty Compact 3/8" Drive Impact Wrench

SKU 802213 24411 **119⁹⁹** REG. \$149.99

- Lightweight and Compact, Only Weighs 3.5 Lbs.
- Fits in One Hand (5-1/4" in Length)
- Air Consumption: 4.7 CFM
- Free Speed: 11,000 RPM
- Working Torque: 280 Ft./Lbs.
- Maximum Torque: 320 Ft./Lbs. Reverse
- Clutch Type: Twin Hammer



SAVE \$30

Offer Good Through June 30, 2017 - While Supplies Last

OEM TOOLS SEE DETAILS, PAGE 70 >>>

Borescope with 2.4" Color LCD Screen

SKU 544746 24383 **129⁹⁹** REG. \$149.99

- Resolution: 640 x 480
- Adjustable LEDs Illuminate the Inspection Area
- 9 mm Probe
- 1 Meter Flexible Shaft
- Includes: Magnet, Mirror and Hook All in a Blow Mold Case



SAVE \$20

Offer Good Through June 30, 2017 - While Supplies Last

OEM TOOLS SEE DETAILS, PAGE 92 >>>

Torque Adaptor, Diesel Head Bolt, Ford 6.0L Power Stroke® Engines

SKU 298191 24208 **24⁹⁹** REG. \$34.99

- Eliminates the Need to Remove the Truck/Van Cab from the Chassis to Access the Rear Head Bolts
- Eliminates the Need to Remove the Evaporator Housing, Saving 2 Hours of Time and the Additional Cost of Refrigerant Added During A/C Recharging
- Prevents Damage to the Rear Heat Shield
- Use with OEMTOOLS® 27309 3/4" Drive Torque Wrench and OEMTOOLS® 22398 18 mm Socket



SAVE \$10

Offer Good Through June 30, 2017 - While Supplies Last

OEM TOOLS SEE DETAILS, PAGE 89 >>>

Professional Battery Tester

SKU 544740 24369 **79⁹⁹** REG. \$99.99

- Easy to Understand Menu-Driven Testing for Battery, Starting and Charging Systems
- Battery CCAs: 240 - 2,000
- Includes Fast Test Mode



SAVE \$20

Offer Good Through June 30, 2017 - While Supplies Last

OEM TOOLS SEE DETAILS, PAGE 93 >>>

Ford Valve Spring Compressor

SKU 626111 24434 **54⁹⁹** REG. \$69.99

- Applications: 1991-2004 Ford Vehicles with 4.6L, 2V, V8 Engines; 4.6 4V, 5.4 V8 and 6.8 V10
- Works with Engine Removed or Installed, Cylinder Head On or Off
- Not for Triton 5.4 3V



SAVE \$15

Offer Good Through June 30, 2017 - While Supplies Last

OEM TOOLS SEE DETAILS, PAGE 27 >>>

Professional 3-in-1 Butane Micro Torch Kit

SKU 420339 24356 **34⁹⁹** REG. \$39.99

- 3-in-1 Design Can Be Used as a Soldering Iron, Torch or Hot Air Blower without Iron Tip
- Easy to Set on Table Top with the Base After Operation
- Micro Torch Kit Includes: Torch, Metal Tip Wicking Cup with Sponge, Heat-Shrink Deflector, Chisel Point Tip, Anvil Solder Tip, Needle Tip and Hot Air/Soldering Tip and Base
- Ideal for Use with Electrical Repair, Tin and Plastic Melting, Heat-Shrinkable Tubing, Auto Repair, Hobby Repair and Jewelry Repair
- Power Range: 30w - 125w



SAVE \$5

Offer Good Through June 30, 2017 - While Supplies Last

TOOL STORAGE

Classic Series Service Carts

Professional 37" 6 Drawer Service Cart

499⁹⁹

Professional Service Carts Feature Injection Molded Corner Bumpers to Protect Vehicles and Other Objects in Your Shop



Lift Gate Service
SKU 295540
DEMLIFTGATE **80⁰⁰**

Available via Outside Buy/EPO,
Call 1-877-298-6651 for ordering instructions.

OEM TOOLS

These 6 Drawer Tool Service Carts Feature:



Locking Top and Drawers



Raise and Release Drawer Latches



Locking Casters



100 Lbs. Capacity Drawer Slides

- Full Extension 100 Lbs. Capacity Slides
- Gas Strut Lids for Easy Opening
- Drawer Liners Included
- Dimensions: 37.4" x 20" x 40.5" (W x D x H)
- Storage Capacity: 9660 Cubic Inches
- 22 Gauge Steel



SKU **420342**
24968 Red



SKU **420340**
24966 Black



SKU **420331**
24969 Green



SKU **OUTSIDE BUY/EPO**
24630 Orange



SKU **420341**
24967 Blue

SAVE UP TO \$199⁹⁹ WHEN YOU PURCHASE COMBO

VALUE: Welded Steel Construction, Stiffeners, Reinforced Stress Points, Heavy Duty Casters and Drawer Slides All with the Most Competitive Pricing in the Market

PRIDE OF OWNERSHIP: The High Quality Powder Coat Finish, Attention to Detail and Smooth Rolling Drawers Give You Tool Storage You Can Brag About to Your Friends and Co-Workers

SECURITY: Tubular Locks and Heavy Duty Locking Mechanism Keep Your Tools Secure

ORGANIZATION: Pick the Combination and Drawer Design to Fit You. A Properly Organized Box Helps You Work Faster and Keep Up with Your Tools.

Montezuma

MTZRR36XOTCLG	\$799.99
Upper Chest	\$499.99
Lower Cabinet	\$499.99
Total	\$999.98
Savings	\$199.99

MTZRR36XOTCOR	\$799.99
Upper Chest	\$499.99
Lower Cabinet	\$499.99
Total	\$999.98
Savings	\$199.99

36" Crossover™ Tool Storage Combo

799⁹⁹

- Designed for Organizational Ease and Tool Visibility
- 36" Crossover Top Chest and 6-Drawer Roller Cabinet Toolbox Combo
- Dimensions: 36" x 18-3/8" x 62-1/2" (W x D x H) - Cubic Inches: 25,508
- Scratch-Resistant Powder Paint and Textured Aluminum Trim
- Interchangeable Drawers with Premium Drawer Liners, Air Tool Holders and 100 Lbs. Ball Bearing Drawer Slides

Green
SKU **547961**
MTZRR36XOTCLG

Red
SKU **547958**
MTZRR36XOTCOR



Lift Gate Service
SKU 301610
MTZLIFTGATE **100⁰⁰**

36" Portable Top Chest

499⁹⁹

- Weather Stripping Creates a Tight Seal Against Dust and Moisture, Great For Road Service
- Gas Spring Raises Lid When Unlatched for Easy Tool Access
- Tool Inventory at a Glance
- 36" x 17-3/8" x 21-1/2" (W x D x H)

Green
SKU **547122**
MTZAG-XL450LG

Red
SKU **547124**
MTZAG-XL4500R



36" 6 Drawer Lower Cabinet

499⁹⁹

- Dimensions: 36-1/2" x 18-1/8" x 41-1/2" (W x D x H) (w/Casters)
- Drawers: (2) 32-1/2" x 15-3/4" x 5", (3) 32-1/2" x 15-3/4" x 2-1/4", (1) 32-1/2" x 15-3/4" x 8"

Green
SKU **547126**
MTZRR3606TCLG

Red
SKU **547123**
MTZRR3606TCPR

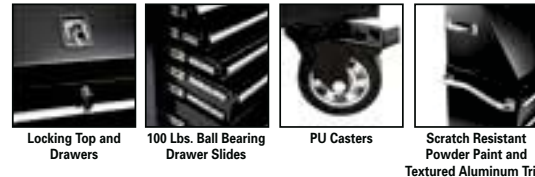

OEM TOOLS

24573	\$899.99
Upper Chest	\$499.99
Lower Cabinet	\$499.99
Total	\$999.98
Savings	\$99.99

Price of Combo is for Chest and Cabinet Only.

36" Tool Storage Combo - Black

SKU **850534**
24573 **899⁹⁹**

- Designed for Organizational Ease and Tool Visibility
- 36" Crossover Top Chest and 6 Drawer Roller Cabinet Tool Box Combo
- Dimensions: 36" x 18-3/8" x 62-1/2" (W x D x H)
- Cubic Inches: 25,508
- Interchangeable Drawers with Premium Drawer Liners, Air Tool Holders and 100 Lbs. Ball Bearing Drawer Slides



Lift Gate Service
SKU 295540
DEMLIFTGATE **80⁰⁰**

36" Portable Top Chest - Black

SKU **850533**
24571 **499⁹⁹**

- 16 Gauge Steel Construction, Welded Seams, No Spot Welding
- 36" x 18" x 21" (W x D x H) with Pegs, Slots, and Holes for Organizing All Your Tools
- Weather Stripping Creates a Tight Seal Against Dust and Moisture



36" 6 Drawer Lower Cabinet - Black

SKU **850535**
24572 **499⁹⁹**

- 36" x 18-3/8" x 40-3/4" (W x D x H) (w/ Casters)
- Cubic Inches: 12,388
- Drawers - (4) 2.5", (1) 5.5", (1) 8.5"
- Embossed Stainless Steel Work Surface



Free Delivery!
in 48 Continental United States

Specifications Subject to Change Without Notice or Liability.
Prices Do Not Include Vehicles, Installation or Optional Equipment as Shown.

Customers Responsible for Off-Loading Equipment Upon Arrival.
Ask Your Sales Rep for Details.

***Leasing Terms Available.**
Ask Your AutoZone® Commercial Sales Manager.



Contact Us:
1-877-AZTool1 Phone
 (1-877-298-6651) *Hablamos Español*

SAVE \$199⁹⁹ WHEN YOU PURCHASE COMBO

OEM TOOLS

72" 26 Drawer Chest and Cabinet Combo

1,699⁹⁹

- Raise and Release Drawer Latches
- Gas Struts for Easy Opening
- Drawer Liners Included
- 20 Gauge Steel Shell
- 22 Gauge Steel Drawers
- Dimensions: 72" x 20" x 63" (W x D x H)

24629/24587/24626	\$1,699.99
10 DRAWER TOP CHEST:	\$699.99
16 DRAWER CABINET:	\$1,199.99
TOTAL:	\$1,899.98
SAVINGS:	\$199.99



Features:



Locking Top and Drawers

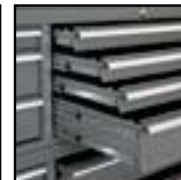

Full Extension 100 Lbs. Capacity Slides



PU Casters



C4 Sandblasted Aluminum Trimmed Drawer Pulls



SKU OUTSIDE BUY/EPO
24629 Blue



SKU OUTSIDE BUY/EPO
24587 Red



SKU OUTSIDE BUY/EPO
24626 Gun Metal Gray

Available via Outside Buy/EPO, Call 1-877-298-6651 for ordering instructions.

Lift Gate Service
SKU 295540
OEMLIFTGATE **80⁰⁰**

72" 10 Drawer Top Chest

699⁹⁹

- Dimensions: 72" x 19.7" x 22.4" (W x D x H)



SKU OUTSIDE BUY/EPO
24627 Blue



SKU OUTSIDE BUY/EPO
24585 Red



SKU OUTSIDE BUY/EPO
24624 Gun Metal Gray



Available via Outside Buy/EPO, Call 1-877-298-6651 for ordering instructions.

Lift Gate Service
SKU 295540
OEMLIFTGATE **80⁰⁰**

72" 16 Drawer Cabinet

1,199⁹⁹

- Dimensions: 72.6" x 20" x 40" (W x D x H)



SKU OUTSIDE BUY/EPO
24628 Blue



SKU OUTSIDE BUY/EPO
24586 Red



SKU OUTSIDE BUY/EPO
24625 Gun Metal Gray



Available via Outside Buy/EPO, Call 1-877-298-6651 for ordering instructions.

Lift Gate Service
SKU 295540
OEMLIFTGATE **80⁰⁰**

SAVE \$199⁹⁹ WHEN YOU PURCHASE COMBO

Features:

- Raise and Release Drawer Latches to Secure Drawers
- EVA Drawer Liners Included
- Gas Struts for Easy Opening



Flat Key Locking System



Full Extension 100 Lbs. Capacity Slides



4 Large Sturdy 5" x 2" Mag Casters 2 Locking



Molded Side Handles

OEM TOOLS

24593	\$699.99
4 DRAWER TOP CHEST:	\$399.99
6 DRAWER CABINET:	\$499.99
TOTAL:	\$899.98
SAVINGS:	\$199.99

36" 10 Drawer Chest and Cabinet Combo Black/Green

SKU OUTSIDE BUY/EPO
24593

699⁹⁹ REG. \$799.99

- Dimensions: 36.7" x 18.1" x 61" (W x D x H)

Lift Gate Service
SKU 295540
OEMLIFTGATE **80⁰⁰**

Available via Outside Buy/EPO, Call 1-877-298-6651 for ordering instructions.

SAVE \$199⁹⁹



Offer Good Through June 30, 2017 - While Supplies Last

24596	\$899.99
6 DRAWER TOP CHEST:	\$499.99
10 DRAWER CABINET:	\$599.99
TOTAL:	\$1,099.98
SAVINGS:	\$199.99

41" 16 Drawer Chest and Cabinet Combo Black/Green

SKU OUTSIDE BUY/EPO
24596

899⁹⁹ REG. \$999.99

- Dimensions: 41" x 18.1" x 61" (W x D x H)

Lift Gate Service
SKU 295540
OEMLIFTGATE **80⁰⁰**

Available via Outside Buy/EPO, Call 1-877-298-6651 for ordering instructions.

SAVE \$199⁹⁹



Offer Good Through June 30, 2017 - While Supplies Last

36" 4 Drawer Top Chest Black/Green

SKU OUTSIDE BUY/EPO
24591

399⁹⁹

- Dimensions: 36.7" x 18.1" x 21.2" (W x D x H)



36" 6 Drawer Cabinet Black/Green

SKU OUTSIDE BUY/EPO
24592

499⁹⁹

- Dimensions: 36.7" x 18.1" x 39.8" (W x D x H)



Lift Gate Service
SKU 295540
OEMLIFTGATE **80⁰⁰**

Available via Outside Buy/EPO, Call 1-877-298-6651 for ordering instructions.

41" 6 Drawer Top Chest Black/Green

SKU OUTSIDE BUY/EPO
24594

499⁹⁹

- Dimensions: 41" x 18.1" x 21.2" (W x D x H)

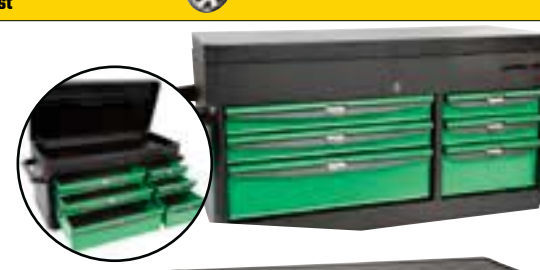

41" 10 Drawer Cabinet Black/Green

SKU OUTSIDE BUY/EPO
24595

599⁹⁹

- Dimensions: 41" x 18.1" x 39" (W x D x H)



Lift Gate Service
SKU 295540
OEMLIFTGATE **80⁰⁰**

Available via Outside Buy/EPO, Call 1-877-298-6651 for ordering instructions.

TOOL STORAGE

Classic Series Tool Storage

Features:



Color Coded Flat Key Locking System



10 Drawers with Full Extension 100 Lbs. Capacity Slides



5" x 2" Casters 2 Locking



Black Aluminum Drawer Pulls and PVC Coated MDF Top

46" 10 Drawer Cabinet and Upper Cabinet - Stainless Steel

SKU OUTSIDE BUY/EPO 24617 **799⁹⁹**

- Drawer Liners Included
- Dimensions: 46" x 18" x 71.5" (W x D x H)
- Stainless Steel



46" 10 Drawer Cabinet - Stainless Steel

SKU OUTSIDE BUY/EPO 24614 **599⁹⁹**

- Dimensions: 46" x 18" x 35.5" (W x D x H)



Available via Outside Buy/EPO, Call 1-877-298-6651 for ordering instructions.

Lift Gate Service SKU 295540 OEMLIFTGATE **80⁰⁰**

24584	\$899.99
8 Drawer Top Chest	\$399.99
11 Drawer Roller Cabinet	\$599.99
Total	\$999.98
Savings	\$99.99

41" 19 Drawer Chest and Cabinet Combo - Black

SKU OUTSIDE BUY/EPO 24584 **899⁹⁹**

- Dimensions: 41.5" x 18" x 62.5" (W x D x H)



SAVE **\$99.99** ON COMBO

41" 8 Drawer Top Chest - Black

SKU OUTSIDE BUY/EPO 24582 **399⁹⁹**

- Dimensions: 41.5" x 18" x 22.4" (W x D x H)

OEM TOOLS



41" 11 Drawer Roller Cabinet - Black

SKU OUTSIDE BUY/EPO 24583 **599⁹⁹**

- Dimensions: 41.6" x 18" x 41.3" (W x D x H)



Features:

- Raise and Release Drawer Latches to Secure Drawers
- Gas Struts for Easy Opening
- Drawer Liners Included
- 22 Gauge Steel Shell

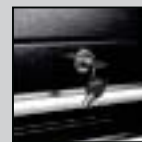

Locking Top and Drawers



100 Lbs. Capacity Slides



5" x 2" Mag Casters 2 Locking

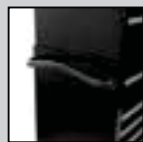

Scratch Resistant Powder Paint and Textured Aluminum Trim

24581	\$1,299.99
7 Drawer Top Chest	\$549.99
11 Drawer Roller Cabinet	\$899.99
Total	\$1,449.98
Savings	\$149.99

56" 18 Drawer Chest and Cabinet Combo - Black

SKU OUTSIDE BUY/EPO 24581 **1,299⁹⁹**

- Dimensions: 55.9" x 20" x 62.7" (W x D x H)



SAVE **\$149.99** ON COMBO

56" 7 Drawer Top Chest - Black

SKU OUTSIDE BUY/EPO 24579 **549⁹⁹**

- Dimensions: 55.4" x 19.8" x 22.4" (W x D x H)



56" 11 Drawer Roller Cabinet - Black

SKU OUTSIDE BUY/EPO 24580 **899⁹⁹**

- Dimensions: 56" x 20" x 41.3" (W x D x H)



Available via Outside Buy/EPO, Call 1-877-298-6651 for ordering instructions.

Lift Gate Service SKU 295540 OEMLIFTGATE **80⁰⁰**

Elite Series Tool Storage

72" 11 Drawer Cabinet, with 3 Door Upper Cabinet - Stainless Steel

SKU OUTSIDE BUY/EPO | 24615

1,049⁹⁹ REG. \$1,099.99

SAVE **\$50**

Add Maximum Storage Space to Your Garage or Work Station. This Stainless Steel Tool Box System Looks Modern and Clean. Helps You Stay Organized and Expands Your Work Space.

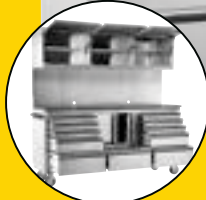

Available via Outside Buy/EPO, Call 1-877-298-6651 for ordering instructions.

Lift Gate Service SKU 295540 OEMLIFTGATE **80⁰⁰**

Features:

- Dimensions: 72" x 18" x 71.5" (W x D x H)
- Upper Cabinet is 12" x 18" (H x D)
- Drawer Liners Included
- Pegboard is 18" Tall
- PVC Coated MDF Top
- Stainless Steel



Color Coded Flat Key Locking System



Full Extension 100 Lbs. Capacity Slides



5" x 2" Heavy Duty Casters



Black Aluminum Drawer Pulls

Offer Good Through June 30, 2017 - While Supplies Last

OEM TOOLS

72" Hutch - Black

SKU OUTSIDE BUY/EPO | 24578

899⁹⁹

- Dimensions: 72" x 30" x 26.3" (W x D x H)



72" Elite 17 Drawer Roller Cabinet - Black

SKU OUTSIDE BUY/EPO | 24577

2,999⁹⁹

- Dimensions: 72" x 30" x 44.2" (W x D x H)

Features:

- Welded Steel Construction
- Pegboard Allows for Additional Storage
- Retractable Door in Hutch
- Adjustable Shelf
- Raise and Release Drawer Latches to Secure Drawers
- Drawer Liners Included
- Comes in Wooden Crate on Pallet with Casters Installed
- 18 Gauge Steel Shell



Keyed Locking System with Tubular Locks

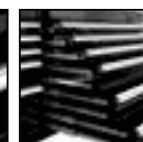

250 Lbs. Ball Bearing Slides



6" Heavy Duty Spring Loaded Casters



Powder Coated Finish with MDF Top

Available via Outside Buy/EPO, Call 1-877-298-6651 for ordering instructions.

Lift Gate Service SKU 295540 OEMLIFTGATE **80⁰⁰**

Free Delivery! in 48 Continental United States

Specifications Subject to Change Without Notice or Liability. Customers Responsible for Off-Loading Equipment Upon Arrival. Prices Do Not Include Vehicles, Installation or Optional Equipment as Shown.

Leasing Terms Available. Ask Your Sales Rep for Details.

Leasing Terms Available. Ask Your AutoZone® Commercial Sales Manager.



Contact Us:
1-877-AZTool1 Phone
 (1-877-298-6651) *Hablamos Español*

SAVE \$199.99 ON A COMBO PURCHASE

OEM TOOLS

41" 10 Drawer Contour Chest and Cabinet Combo

- Patented Raise and Release Drawer Latches to Secure Drawers
- EVA Drawer Liners Included
- Gas Struts on Lids for Easy Opening
- Double Drawer Slides on Larger Drawers
- Dimensions: 41" x 18" x 60.4" (W x D x H)

24590/24620/24623	\$899.99
4 DRAWER TOP CHEST:	\$499.99
6 DRAWER CABINET:	\$599.99
TOTAL:	\$1,099.98
SAVINGS:	\$199.99

899⁹⁹ REG. \$999.99

SAVE \$199⁹⁹



Features:



Locking Top and Drawers



Full Extension 100 Lbs. Capacity Slides for Easy Access



4 Sturdy 5" x 1.5" Tire Style Casters with Wheel Locks



One Stainless Steel Handle on Cabinet



Race Blue with White Stripes
 SKU OUTSIDE BUY/EPO 24590



Orange with White Stripes
 SKU OUTSIDE BUY/EPO 24620



Green and Matte Black
 SKU OUTSIDE BUY/EPO 24623

Lift Gate Service
 SKU 295540
 OEMLIFTGATE **80⁰⁰**

Available via Outside Buy/EPO,
 Call 1-877-298-6651 for ordering instructions.

Offer Good Through June 30, 2017 - While Supplies Last

41" 4 Drawer Contour Top Chest

- Dimensions: 41" x 18" x 19.4" (W x D x H)

- Race Blue with White Stripes
 SKU OUTSIDE BUY/EPO 24588
- Orange with White Stripes
 SKU OUTSIDE BUY/EPO 24618
- Green and Matte Black
 SKU OUTSIDE BUY/EPO 24621

499⁹⁹



Available via Outside Buy/EPO,
 Call 1-877-298-6651 for ordering instructions.

Lift Gate Service
 SKU 295540
 OEMLIFTGATE **80⁰⁰**

41" 6 Drawer Contour Cabinet

- Dimensions: 41" x 18" x 41" (W x D x H)

- Race Blue with White Stripes
 SKU OUTSIDE BUY/EPO 24589
- Orange with White Stripes
 SKU OUTSIDE BUY/EPO 24619
- Green and Matte Black
 SKU OUTSIDE BUY/EPO 24622

599⁹⁹



Available via Outside Buy/EPO,
 Call 1-877-298-6651 for ordering instructions.

Lift Gate Service
 SKU 295540
 OEMLIFTGATE **80⁰⁰**

Trade Series Tool Storage

OEM TOOLS

Features:

- Gas Springs for Easy Opening
- Drawer Liners Included
- Dual Gloss and Hammer Tone Powder Coat Finish Resist Rust
- 22 Gauge Steel Shell
- Dimensions: 26.5" x 18.3" x 52.4" (W x D x H)



Flat Key Locking System



Full Extension 66 Lbs. Capacity Slides



(4) 5" x 2" Casters (2 Swivel with Brakes and 2 Rigid)



Aluminum Pulls

SAVE \$99.99 ON COMBO OFFER!

24599	\$399.99
6 DRAWER TOP CHEST:	\$199.99
6 DRAWER CABINET:	\$299.99
TOTAL:	\$499.98
SAVINGS:	\$99.99

26" 12 Drawer Chest and Cabinet Combo - Blue

SKU OUTSIDE BUY/EPO 24599
399⁹⁹ REG. \$479.99

- Dimensions: 26.5" x 18.3" x 52.4" (W x D x H)

SAVE \$99⁹⁹

Available via Outside Buy/EPO,
 Call 1-877-298-6651 for ordering instructions.

Offer Good Through June 30, 2017 - While Supplies Last



Lift Gate Service
 SKU 295540
 OEMLIFTGATE **80⁰⁰**

26" 6 Drawer Top Chest - Blue

SKU OUTSIDE BUY/EPO 24597
199⁹⁹

- Dimensions: 26.2" x 12" x 14.1" (W x D x H)

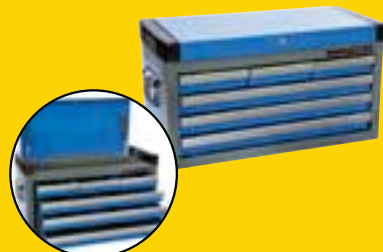

26" 6 Drawer Cabinet - Blue

SKU OUTSIDE BUY/EPO 24598
299⁹⁹

- Dimensions: 26.5" x 18.3" x 37.9" (W x D x H)



SAVE \$199.99 ON COMBO OFFER!

24613	\$599.99
8 DRAWER TOP CHEST:	\$349.99
5 DRAWER CABINET:	\$449.99
TOTAL:	\$799.98
SAVINGS:	\$199.99

41" 13 Drawer Chest and Cabinet Combo - Blue

SKU OUTSIDE BUY/EPO 24613
599⁹⁹ REG. \$699.99

- Dimensions: 41.4" x 16" x 56.6" (W x D x H)

SAVE \$199⁹⁹

Offer Good Through June 30, 2017 - While Supplies Last



Available via Outside Buy/EPO,
 Call 1-877-298-6651 for ordering instructions.

Lift Gate Service
 SKU 295540
 OEMLIFTGATE **80⁰⁰**

41" 8 Drawer Top Chest - Blue

SKU OUTSIDE BUY/EPO 24611
349⁹⁹

- Dimensions: 40.5" x 12" x 18.7" (W x D x H)



41" 5 Drawer Cabinet - Blue

SKU OUTSIDE BUY/EPO 24612
449⁹⁹

- Dimensions: 41.4" x 16" x 37.9" (W x D x H)



Service Trays

OEM TOOLS

SAVE \$5

29" Portable Tear Down Trays

- Adjustable Table Height: 33-1/2" to 49-1/4"
- Total Weight Capacity: 55 Lbs.
- EVA Foam Work Surface Liners
- 29.1" x 20.1" Work Surface
- Rubber Bumper Corners

SKU 512947
 24960 Black
74⁹⁹
 REG. \$79.99



SKU 850045
 24616 Green
74⁹⁹
 REG. \$79.99



Features:



Adjustable Heights



Portable



Divider Tray with EVA Liners

Offer Good Through June 30, 2017
 While Supplies Last

TOOL STORAGE

SAVE BIG ON TECHNICIAN SETS

OEM TOOLS

SAVE \$529⁹⁹

Tool Set Savings: \$180.00
 Bonus Tool Cart: \$349.99
TOTAL SAVINGS: \$529.99

OEM TOOLS
 Professional Quality Tools



This set includes 167 of the most common tools used by technicians. All in a great looking 5 drawer cart.

Items Subject to Change

167 Piece Mechanic's Set

819⁹⁹ REG. \$999.99

SKU 533204 | Part# 24974

Includes:

- 1/4", 3/8" and 1/2" Drive Tools
- Hand Tools
- Battery Service Tools
- Oil Change Tools
- And More

BONUS
5 Drawer Service Cart
 SKU 512950 | Part# 24963
VALUE: \$349.99

With Purchase of:
167 Piece Mechanic's Set
 SKU 533204 | Part# 24974

Offer Good Through June 30, 2017
 While Supplies Last



SAVE \$649⁹⁹

Tool Set Savings: \$350.00
 Bonus Tool Cart: \$299.99
TOTAL SAVINGS: \$649.99

OEM TOOLS
 Professional Quality Tools



160 of the most popular tools used by lube techs.

Items Subject to Change

160 Piece Lube Tech Starter Set

999⁹⁹ REG. \$1,349.99

SKU 227302 | Part# 24965

Includes:

- Hand Tools
- Battery and Tire Service Tools
- Battery Service Tools
- Specialty Oil Filter Wrenches to Service Late Model Cars and Trucks

BONUS
4 Drawer Service Cart
 SKU 512949 | Part# 24962
VALUE: \$299.99

With Purchase of:
160 Piece Lube Tech Starter Set
 SKU 227302 | Part# 24965

Offer Good Through June 30, 2017
 While Supplies Last



SAVE \$849⁹⁹

Tool Set Savings: \$500.00
 Bonus Tool Cart: \$349.99
TOTAL SAVINGS: \$849.99

OEM TOOLS Professional Quality Tools



Items Subject to Change

312 Piece Technician's Set

1,399⁹⁹ REG. \$1,899.99

SKU 533203 | Part# 24975

Includes:

- 1/4", 3/8" and 1/2" Drive Tools
- Hand Tools
- Battery Service Tools
- Oil Change Tools
- And More

BONUS
5 Drawer Service Cart
 SKU 512950 | Part# 24963
VALUE: \$349.99

With Purchase of:
312 Piece Technician's Set
 SKU 533203 | Part# 24975

Offer Good Through June 30, 2017
 While Supplies Last



SAVE \$949⁹⁹

Tool Set Savings: \$600.00
 Bonus Tool Cart: \$349.99
TOTAL SAVINGS: \$949.99

OEM TOOLS
 Professional Quality Tools



Items Subject to Change

350 Piece Apprentice Starter Set

1,899⁹⁹ REG. \$2,499.99

SKU 227300 | Part# 24964

Includes:

- 1/4", 3/8" and 1/2" Drive Tools
- Air Tools
- Hand Tools
- Brake Service Tools
- Battery Service Tools
- Oil Change Tools
- Tire Tools
- And More

BONUS
5 Drawer Service Cart
 SKU 512950 | Part# 24963
VALUE: \$349.99

With Purchase of:
350 Piece Apprentice Starter Set
 SKU 227300 | Part# 24964

Offer Good Through June 30, 2017 - While Supplies Last





Contact Us:
1-877-AZTool1 Phone
 (1-877-298-6651) *Hablamos Español*

AutoZone® Tool & Equipment QUARTERLY

Service Carts

Hi-Impact Structural Polypropylene Service Carts (500 Lbs. Capacity)

Standard Service Cart

SKU 751723 24957 **99⁹⁹**
 • Cart Dimensions: 33-5/8" x 17-5/16" x 40-3/8" (H x W x L)

Large Service Cart

SKU 751722 24958 **129⁹⁹**
 • Cart Dimensions: 33-2/3" x 25-3/4" x 46-7/8" (H x W x L)

- Stands Up to Rugged Use
- (2) Large 3" Deep Trays Keep Load Secure While Transporting
- Easy Assembly
- Heavy Duty Polypropylene is Easy to Clean, Resistant to Rust, Denting and Chipping
- Maximum Weight Carrying Capacity of 500 Lbs. (250 Lbs. per Shelf)
- Smooth Rolling, Non-Marring 5" Casters



Cup and supplies not included.

Professional Service Cart 5 Drawer and 1 Tray

SKU 298231 24570 Green **279⁹⁹** REG. \$299.99

- Unique Raise and Release Drawer Latches to Prevent Drawers from Drifting Open
- Durable Powder Coated Finish
- Each Drawer Loading Capacity of 75 Lbs.
- Total Load Capacity of 500 Lbs.
- Dimensions: 49" L x 18" D x 37" H (with Tray Extended)



SAVE \$20

Offer Good Through June 30, 2017 - While Supplies Last

Professional Service Cart 5 Drawer and 1 Tray Features:



Professional Service Cart 5 Drawer and 1 Tray

SKU 512950 24963 Black

349⁹⁹

See Details Above



2 Tray Service Cart

SKU 432099 24959 **99⁹⁹** REG. \$119.99

- 4" Swivel Casters: (2) Locking and (2) Standard
- Dimensions: 30" x 16" x 35.3" (W x D x H)
- Load Capacity: 350 Lbs.



SAVE \$20

Offer Good Through June 30, 2017 While Supplies Last

Service Cart with Locking Lid and Drawer

SKU 512948 24961 **149⁹⁹**

- Easy to Maneuver with (4) Swivel Casters
- Stays Securely in Place with (2) Locking Casters
- Total Load Capacity: 350 Lbs.
- Drawer Load Capacity: 75 Lbs.
- Full Length Aluminum Drawer Handles
- Chrome Tube Legs
- Durable Powder Coated Finish
- Ball Bearing Slides
- Dimensions: 30" (H) x 18" (D) x 30" (L)

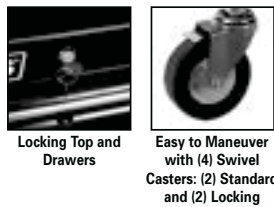

Professional Service Cart 4 Drawer and 1 Tray

SKU 512949 24962 **299⁹⁹**

- Aluminum Trimmed Drawer Pulls with Raise and Release
- Durable Powder Coated Finish
- Easy to Maneuver with (4) Swivel Casters: (2) Standard and (2) Locking
- 75 Lbs. Ball Bearing Slide
- Total Load Capacity of 500 Lbs.
- Dimensions: 49" L x 18" D x 36" H (with Tray Extended)

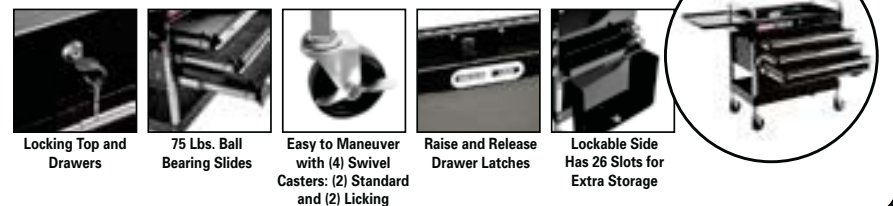

Socket Organizers

Socket Boss - 2 Rail Socket Tray (3/8" Drive)

SKU 255123 ERN8453 **24⁹⁹**

- Holds (30) Sockets
- Twist-Lock Clips Keep Sockets Secured



Socket Boss - 3 Rail Socket Tray (1/4", 3/8", 1/2" Drive)

- Holds (45) Sockets in Three Drive Sizes
- Push Button Release to Remove Any Rail

Red SKU 255105 ERN8450 **29⁹⁹**

Blue SKU 255120 ERN8451 **29⁹⁹**



Dura-Pro Twist-Lock Cart Mount Socket System (3/8" Drive)

SKU 255131 ERN8466 **34⁹⁹**

- Holds (30) Sockets and (4) Ratchets or Extensions
- Just a Simple 1/8th Turn and Your Tools are Secured

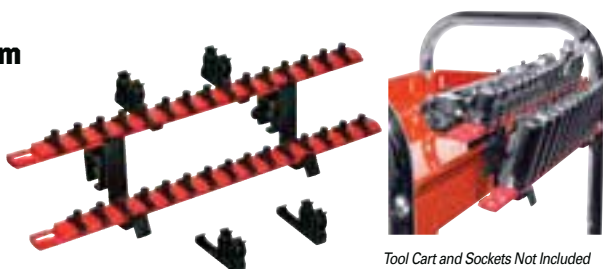

Tool Cart and Sockets Not Included

Complete Tool Organizing System with Twist-Lock Socket Clips

SKU 255094 ERN8480 **69⁹⁹**

- 1/4", 3/8" and 1/2" Drive
- Makes Your Tools Easy to Find
- Holds (126) Wrenches, Screwdrivers, Sockets, Ratchets and Extensions



Work Stand

Pro Step Adjustable Work Stand

SKU 222856 STK20350 **164⁹⁹**

- Height Adjustable from 6-1/2" to 22-1/2"
- Capacity: 500 Lbs.
- 32" x 16"
- Foam Bumpers Protect Vehicle Finish
- Spring-Loaded Retractable Wheels - You Can Push it with Your Foot, Stays Put When a Load is Present
- Extra-Wide 23" Base Rails for Stability
- Heavy Duty (Weight: 45 Lbs.) Construction



Trays and Racks

Plier/Wrench Rack

- Will Hold Up to (13) Tools
- (2) Different Size Slots to Accommodate All Sizes of Tools
- 11" (W) x 7" (H) x 2" (D)

Red SKU 255888 LIS40490 **22⁹⁹**

Black SKU 255882 LIS40460 **22⁹⁹**



Magnetic Trays

10" x 11" Magnetic Tray

SKU 965835 25119 **24⁹⁹** Tools Not Included

- (4) Powerful Magnets with Protective Rubber Coating to Resist Scratching
- Strong and Durable to Collect Small Parts, Fasteners and Tools
- Heavy Duty Stainless Steel



Ideal for Holding Small Parts and Tools

10" Magnetic Nut Tray

SKU 434570 GRI67435 **29⁹⁹**

- Teflon® Coated Steel Resists Scratches and Corrosion
- 3 Rubber-Covered Magnets Keep the Tray and Parts Securely in Place
- 10" Wide x 2" Depth



POWER TOOLS

Makita
World's Largest
18V Li-Ion
Tool Platform



BONUS GET ITEMS BELOW

12V Max Li-Ion 3/8" Driver-Drill **NEW**
SKU 592328 (Tool Only)
MAKFD02ZW
Value: \$79.99



And
12V Li-Ion Battery
SKU 555438
MAKBL1014
Value: \$49.99



With Purchase of:
12V Li-Ion 3 Piece Combo Kit
SKU 555406 | MAKLCT319W
or
12V Li-Ion 3 Piece Combo Kit
SKU 555405 | MAKLCT309W
or
12V Li-Ion 4 Piece Combo Kit
SKU 555408 | MAKLCT401W

BUY ANY ONE OF THE TOOLS BELOW

12V Li-Ion 3 Piece Combo Kit

SKU 555406
MAKLCT319W **219⁹⁹**
• 3/8" Impact Wrench: 83 Ft./Lbs of Torque
• 1/4" Hex Shank Impact Driver: 800 In./Lbs of Torque
• Both Tools Have Built-In LED Lights To Illuminate the Work Area



- 2 - 12V Li-Ion Batteries for Long Life
- Battery Charger and Tool Case



12V Li-Ion 3 Piece Combo Kit

SKU 555405
MAKLCT309W **264⁹⁹**
• 3/8" Drill Driver: (0-350 and 0-1,300 RPM)
• 3/8" Impact Wrench: 1,000 In./Lbs. of Max Torque (0-2,300 RPM and 0-3,000 IPM)

- Flashlight Runs Up to 9 Hours on a Single Charge
- (2) 12V Max Li-Ion Batteries
- Battery Charger and Tool Case



12V Li-Ion 4 Piece Combo Kit

SKU 555408
MAKLCT401W **289⁹⁹**
• Impact Wrench: 83 Ft./Lbs. of Torque
• Hex Shank Impact Driver: 800 In./Lbs. of Torque
• Driver Drill: 200 In./Lbs. of Torque

- All Tools Have Built-In LED Lights to Illuminate the Work Area
- (2) Li-Ion Batteries and a Battery Charger are Included



Tool Only, Does Not Include Battery Offer Good Through June 30, 2017 - While Supplies Last

BONUS GET ITEM BELOW

18V LXT® Li-Ion Sub-Compact Brushless 1/2" Driver-Drill **NEW**
SKU 592347 (Tool Only)
MAKXFD11ZB
Value: \$129.99



With Purchase of
18V Hi Torque Impact Wrench Kit
SKU 850509 | MAKXWT08M or
18V LXT® Li-Ion 2 Piece Combo Kit
SKU 592332 | MAKXT270

18V LXT® Li-Ion 2 Piece Combo Kit

SKU 592332
MAKXT270 **499⁹⁹**
• Delivers 740 Ft./Lbs. of Max Torque and 1,180 Ft./Lbs. of Breakaway Torque
• 3-Speed Switch (0-900/ 0-1,000/ 0-1,800 RPM & 0-1,800/ 0-2,000/ 0-2,200 IPM)

18V Hi Torque Impact Wrench Kit **NEW**
SKU 850509
MAKXWT08M **499⁹⁹**
• 1,180 Ft./Lbs. of Breakaway Torque
• 740 Ft./Lbs. of Fastening Torque
• 3 Speed Selections
• Dual LED Lights
• Includes BL1840 Battery



• Variable Speed Impact Driver (0-2,900 RPM & 0-3,500 IPM) Delivers 1,460 In./Lbs. of Torque
• Compact and Ergonomic Design at 5-3/8" Long Weighing 3.9 Lbs.
• Features Extreme Protection Technology (XPT™) to Provide Increased Dust and Water Resistance in Harsh Conditions



Offer Good Through June 30, 2017 - While Supplies Last

BONUS

12V Max CXT™ Li-Ion 2.0Ah Battery **NEW**
SKU 592260
MAKBL1021B
Value: \$59.99



With Purchase of
12V Max CXT™ Li-Ion 2 Piece Combo Kit (2.0Ah)
SKU 592273 | MAKCT230R

12V Max CXT™ Li-Ion 2 Piece Combo Kit (2.0Ah)

SKU 592273
MAKCT230R **219⁹⁹**
• Kit Includes 1/4" Hex Driver-Drill, 1/4" Impact Driver and (2) 12V Max CXT™ Batteries
• 1/4" Hex Driver-Drill with 2 Speeds (0-450 & 0-1,700 RPM) and Up to 250 In./Lbs. of Max Torque
• Impact Driver with Variable Speed (0-2,600 RPM & 0-3,500 IPM) Up to 970 In./Lbs. of Max Torque



NEW



Offer Good Through June 30, 2017 While Supplies Last

Impact Drivers

12V Li-Ion 1/4" Hex Shank Impact Driver Kit

SKU 555430
MAKDT01W **124⁹⁹**

- 800 In./Lbs. of Torque and 0-2,400 RPM for a Variety of Applications
- Built-In LED Light Illuminates the Work Area
- Lightweight: 2.0 Lbs.
- (2) 12V Li-Ion Batteries
- Includes Charger and Case



12V Impact Driver Kit

SKU 010106
MAKDT03R1 **149⁹⁹**

- Delivers 970 In./Lbs. of Torque
- 0-2600 RPM and 0-3500 IPM
- Built-In LED Light
- Lightweight at Only 2.3 Lbs.



18V Impact Driver Kit

SKU 803113
MAKXDT042 **149⁹⁹**

- Variable Speed (0-2,300 RPM & 0-3,200 IPM) for a Wide Range of Fastening Applications
- Equipped with Star Protection Computer Controls™
- Rapid Optimum Charger Communicates with the Battery's Built-in Chip
- Rapid Optimum Charger Has a Built-in Fan to Cool the Battery



18V Compact Li-Ion 1/2" Cordless Impact Driver Kit

SKU 818601
MAKXDT11R **169⁹⁹**

- Delivers 1,460 In./Lbs. of Maximum Torque
- Variable Speed (0-2,900 RPM and 0-3,500 IPM)
- Includes: XDT04RW 1/4" Hex Shank Impact Driver, (2) BL1820 18V 2.0 Ah Li-Ion Batteries, DC18RA Rapid Charger



BONUS

18V LXT® Li-Ion Cordless LED Flashlight (Tool-Only)
SKU 849458
MAKDML802
Value: \$54.99



With Purchase of
18V LXT® 3/8" Impact Wrench Kit
SKU 434595 | MAKXWT06RB

18V LXT® 3/8" Impact Wrench Kit

SKU 434595
MAKXWT06RB **339⁹⁹**
• Makita-Built 4-Pole Motor Delivers 155 Ft./Lbs. of Max Torque
• Variable Speed (0-2,100 RPM & 0-3,200 IPM)
• Compact and Ergonomic Design at Only 6-1/8" Long
• Rubberized Soft Grip Handle
• Built-in LED with Afterglow
• Comes with 18V Li-Ion Rapid Optimum Charger and 3.0 Ah Battery



Offer Good Through June 30, 2017 While Supplies Last

BONUS

18V Li-Ion 2.0 Ah Battery
SKU 849432
MAKBL1820B
Value: \$99.99



With Purchase of
18V LXT® Li-Ion Compact 2 Piece Combo Kit
SKU 592293 | MAKXT272R

18V LXT® Li-Ion Compact 2 Piece Combo Kit

SKU 592293
MAKXT272R **379⁹⁹**
• Variable Speed Impact Driver (0-2,900 RPM & 0-3,500 IPM) Delivers 1,460 In./Lbs. of Torque
• Impact Driver is Only 5-3/8" Long, Weighing 3.9 Lbs. with Battery
• Variable Speed Impact Wrench (0-2,100 RPM & 0-3,200 IPM) Delivers 155 Ft./Lbs. of Max Torque



NEW



Offer Good Through June 30, 2017 - While Supplies Last

BONUS

Rapid Optimum Charger
SKU 555439
MAKDC18RC
Value: \$99.99



With Purchase of
18V LXT® Li-Ion 1/2" Impact Wrench with 18V Li-Ion 3.0 Ah Battery
SKU 434676 | MAKXWT05K

18V LXT® Li-Ion 1/2" Impact Wrench with 18V Li-Ion 3.0Ah Battery

SKU 434676
MAKXWT05K **279⁹⁹**
• Makita-Built 4-Pole Motor Delivers 170 Ft./Lbs. of Max Torque (0-2,100 RPM & 0-3,200 IPM)
• Compact and Ergonomic Design at Only 6.5" Long and Weighing Only 3.8 Lbs. with Battery
• Built-in LED Light with Afterglow Illuminates the Work Area
• Equipped with Star Protection Computer Controls™ to Protect Against Overloading, Over-Discharging and Over-Heating



Offer Good Through June 30, 2017 While Supplies Last

BONUS

18V LXT® Li-Ion Sub-Compact Brushless Impact Driver (Tool-Only) **NEW**
SKU 592340
MAKXDT15ZB
Value: \$129.99



With Purchase of
18V Auto Combo Kit
SKU 818600 | MAKXT311R

18V Auto Combo Kit

SKU 818600
MAKXT311R **459⁹⁹**
• 3/8" Impact with 155 Lbs. of Torque
• 1/2" Driver with 480 Lbs. of Torque
• BML185 Flashlight
• (2) BL1820 2.0 Ah Li-Ion Batteries
• 18V LXT Li-Ion Cordless Flashlight
• Tote Bag



Offer Good Through June 30, 2017 - While Supplies Last

BONUS

18V Li-Ion Radio (Tool Only)
SKU 696480
MAKXRM02W
Value: \$104.99



With Purchase of
18V LXT® Li-Ion Cordless Combo Kit
SKU 696478 | MAKLXT320

18V LXT® Li-Ion Cordless Combo Kit

SKU 696478
MAKLXT320 **479⁹⁹**
• 3/8" Impact Wrench Provides 155 Ft./Lbs. of Max Torque
• Impact Driver Provides 1,420 In./Lbs. of Max Torque
• Extra Bright 12 LED Flashlight Has 240 Lumens and Rotates Left to Right
• (2) 18V LXT Li-Ion 3.0 Ah Batteries That Reach Full Charge in 30 Minutes
• Rapid Optimum Charger Optimize Battery Life by Actively Controlling Current, Voltage, and Temperature



• Tool Bag

Impact Wrenches

12V Li-Ion 3/8" Impact Wrench Kit

SKU 555429
MAKWT01W **159⁹⁹**

- 83 Ft./Lbs. of Torque and 0-2,300 RPM
- Built-In LED Light Illuminates the Work Area
- (2) 12V Li-Ion Batteries
- Includes Charger and Case
- 60-Minute Battery Charger



18V Li-Ion 1/2" HD Impact Wrench Kit

SKU 555415
MAKXWT04 **439⁹⁹**

- 325 Ft./Lbs of Torque
- Variable Speed for Ease of Use
- Built-In LED
- Includes 2- 18V 3.0Ah Li-Ion for Continuous Operation
- Rapid Charger
- Tool Case



18V LXT® Li-Ion Cordless High Torque 1/2" Impact Wrench Kit

SKU 849459
MAKXWT04MB **499⁹⁹**

- Delivers 325 Lbs. of Torque
- 1/2" Square Drive
- 1,600 RPM and 2,200 IPM
- Includes BL1840B Battery





Contact Us:
1-877-AZTool1 Phone
 (1-877-298-6651) *Hablamos Español*

AutoZone®

Tool & Equipment QUARTERLY

12V Combo Kits

12V Combo Kit

SKU 677405
 MAKLC209W **149⁹⁹**

- 3/8" Driver Drill Impact Driver
- (2) 12V Max Batteries
- Battery Charger and Case



12V Li-Ion 3 Piece Combo Kit

SKU 555423
 MAKLC214W **159⁹⁹**

- 2 Speed 3/8" Driver-Drill: (0-350 and 0-1,300 RPM) Delivers 200 In./Lbs. of Max Torque
- Variable Speed Impact Driver: (0-2,400 RPM and 0-3,000 IPM) Provides 800 In./Lbs. of Max Torque
- Flashlight Runs Up to 9 Hours on a Single Charge
- (2) Makita 12V max Li-Ion Batteries
- Battery Charger and Case



12V Li-Ion Cordless Combo Kit

SKU 847089
 MAKCT226 **199⁹⁹**

- 3/8" Driver Drill with 210 Lbs. of Max Torque
- 1/4" Impact Driver with 970 Lbs. of Max Torque
- Includes (2) 12V Slide Batteries
- Batteries Charge in 25 Minutes
- Built-In LED Light



12V Cordless Combo Kit

SKU 434634
 MAKCT226RX **199⁹⁹**

- 3/8" Driver-Drill with 2 Speeds (0-450 and 0-1,700 RPM) Delivers Up to 250 In./Lbs. of Max Torque
- Impact Driver with Variable Speed (0-2,600 RPM and 0-3,500 IPM) Up to 970 In./Lbs. of Max Torque
- Ergonomically Designed Handles with Rubberized Soft Grips
- 12V max CXT™ Slide Battery Design



18V Combo Kit

18V Compact Combo Kit

SKU 434602
 MAKCT225R **279⁹⁹**

- 1/2" Driver-Drill (0-600 & 0-1,900 RPM) Delivers 480 In./Lbs. of Max Torque
- Impact Driver with Variable Speed (0-2,900 RPM & 0-3,500 IPM) Delivers 1,460 In./Lbs. of Max Torque
- Star Protection Computer Controls™ Protect Against Overloading, Over-Discharging and Over-Heating
- 18V Compact 2.0 Ah Battery MAKBL1820B Provides Up to 50% More Run Time Than MAKBL1815



• Includes - (2) 18V MAKBL1820B 2.0 Ah Batteries, Rapid Charger, and Tool Bag

Drills

12V Li-Ion 3/8" Driver Drill Kit

SKU 555431
 MAKFD02W **129⁹⁹**

- 3/8" Driver Drill with Keyless Chuck
- 200 In./Lbs. of Torque
- 0 - 350 and 0 - 1,300 RPM
- Built-In LED Light Illuminates the Work Area
- Includes: (2) 12V Li-Ion Batteries, Charger and Case



18V 1/2" Hammer Drill Driver

SKU 803111
 MAKXPH012 **139⁹⁹**

- 18V LXT Li-Ion Hammer Driver Drill
- 480 In./Lbs. of Torque
- Includes: Battery, Charger and Case



12V 3/8" Driver Drill Kit

SKU 010110
 MAKFD05R1 **149⁹⁹**

- Delivers Up to 250 In./Lbs. of Torque
- 2 Speeds: 0-450 and 0-1700 RPMs
- Adjustable Clutch
- Built-In LED Lights



18V Compact Li-Ion Cordless 1/2" Driver-Drill Kit, (2.0 Ah)

SKU 818602
 MAKXFD10R **164⁹⁹**

- Variable Speeds 0 - 400 and 0 - 1500 RPM
- 480 In./Lbs. Torque
- Kit Includes: XFD10 18V 1/2" Li-Ion Driver Drill, (2) BL1820B 18V Li-Ion 2.0 Ah Batteries and DC18RC Charger



Grinders

4-1/2" 7.5 Amp Grinder - Corded

SKU 555432
 MAK9557PB **99⁹⁹**

- 4-1/2" Grinder with 10,000 RPM for Fast Material Removal
- Powerful 7.5 Amp Motor for Heavy Duty Applications



18V LXT® Li-Ion Brushless 4-1/2" Paddle Switch Cut-Off/Angle Grinder (Tool Only)

SKU 297320
 MAKXAG06Z **169⁹⁹**

- Automatic Speed Change™ Technology Adjusts Speed and Torque During Operation for Optimum Performance
- Electronic RPM Controller Turns Motor Off if Rotation Speed Suddenly Slows
- Brushless Motor Eliminates Carbon Brushes
- Electronically Controlled to Optimize Battery Energy Use for Up to 50% Longer Run Time



18V LXT® Li-Ion Brushless 4-1/2" Paddle Switch Cut-Off/Angle Grinder Kit

SKU 297327
 MAKXAG06MB **419⁹⁹**

- Automatic Speed Change™ Technology Adjusts Speed and Torque During Operation for Optimum Performance
- Electronic RPM Controller Turns Motor Off if Rotation Speed Suddenly Slows
- Brushless Motor Eliminates Carbon Brushes
- Electronically Controlled to Optimize Battery Energy Use for Up to 50% Longer Run Time
- Includes (2) 18V BL1840B Batteries, (1) 18V Rapid Optimum Charger, Tool Case, and Grinding Wheels & Wheel Guards



Reciprocating Saw

9 Amp Reciprocating Saw HD - Corded

SKU 262515
 MAKJR3050T **119⁹⁹**

- Long 1-1/8" Stroke for Faster Cutting
- Internal Dust Blower System Clears Debris from the Line of Cut for Better Visibility and Accuracy
- All Ball and Needle Bearing Construction for Longer Tool Life
- Soft Grip for Increased Comfort and Control



BUY ANY ONE OF THE TOOLS BELOW

7" Polisher

SKU 592264
 MAK9227C **239⁹⁹** **NEW**

- Powerful 10 AMP Motor Delivers 0-3,000 RPM
- Variable Speed Control Dial
- Constant Speed Control Maintains Constant Speed Under Load
- Soft Start Feature for Smooth Start-Ups
- 3-Prong Plug to Prevent Static Electricity Accumulation



7" Polisher Kit

SKU 592241
 MAK9237C **249⁹⁹** **NEW**

- Variable Speed Dial and Trigger
- Constant Speed Control Maintains Constant Speed Under Load
- Soft Start for Smooth Start-up
- Rubberized Loop Handle and Gear Housing



- Easily Converts to a Sander
- Wire Mesh Intake Covers to Prevent Wool Fibers From Entering the Motor
- Includes Tool Bag and (2) Bonnets

BONUS GET ITEM BELOW

7" Wool Bonnet

SKU 592244
 MAK743403A **Value: \$19.99**



With Purchase of:

7" Polisher

SKU 592264 | MAK9227C
 or
 7" Variable Kit
 SKU 592241 | MAK9237C

NEW

Offer Good Through June 30, 2017
 While Supplies Last

Batteries/Chargers

18V Li-Ion 2.0 Ah Battery

SKU 555436
 MAKBL1820 **79⁹⁹**

- 18V Li-Ion 2.0 Ah Battery Provides 50% More Runtime Than a 1.5 Ah Battery
- Charges in 25 Minutes
- Powers All 80+ Makita 18V Li-Ion Tool Models

18V Li-Ion 3.0 Ah Battery

SKU 262507
 MAKBL1830 **109⁹⁹**

- Compatible with All Makita 18V LXT® and 18V Compact Cordless Tools



18V Li-Ion 4.0 Ah Battery

SKU 555437
 MAKBL1840 **99⁹⁹**

- 18V Li-Ion 4.0 Ah Battery Provides 30% More Runtime Than a 3.0 Ah Battery
- Charges in 35 Minutes
- Powers All 80+ Makita 18V Li-Ion Tool Models

LED Battery Charge Level Indicator

18V Li-Ion 2.0 Ah Battery

SKU 849432
 MAKBL1820B **99⁹⁹**

- 50% More Runtime Than BL1815
- Charges in 25 Minutes

18V Li-Ion 4.0 Ah Battery

SKU 849464
 MAKBL1840B **139⁹⁹**

- 35% More Runtime Than BL1830
- Charges in 40 Minutes



18V 5.0 Ah Battery

SKU 849454
 MAKBL1850B **149⁹⁹**

- 65% More Runtime Than BL1830
- Charges in 45 Minutes

12V Li-Ion Battery

SKU 555438
 MAKBL1014 **49⁹⁹**

- 12V Li-Ion Battery Powers All Makita 12V Li-Ion Tool Models
- Charges in Only 20 Minutes



18V Dual Port Charger

SKU 751667
 MAKDC18RD **129⁹⁹**

- Built-In USB Port for Charging Portable Electronic Devices
- Rapid Charge



18V 4.0 Ah Battery and Rapid Charger Kit

SKU 847086
 MAKBL1840DC1 **179⁹⁹**

- Full Charge in 40 Minutes
- Shock-Absorbing Inner Liner to Protect Battery
- Powers in Extreme Temperatures



18V Lighting

18V LXT® Li-Ion Cordless 12 LED Flashlight (Tool Only)

SKU 849456
 MAKDML801 **54⁹⁹**

- 240 Lumens
- Head Rotates 7 Directions
- Metal Hang Hook Swivels 360°
- 2 Modes - Full Brightness and Half Brightness
- Up to 40 Hours of Illumination at Half Brightness



Tool Only, Does Not Include Battery or Charger

18V LXT® Li-Ion Cordless LED Flashlight (Tool Only)

SKU 849458
 MAKDML802 **54⁹⁹**

- 200 Lumens
- 12 Position Pivoting Flashlight Head
- Metal Hanging Hook
- Up to 13 Hours of Continuous Illumination



Tool Only, Does Not Include Battery or Charger

18V LXT® Li-Ion LED Lantern/Flashlight (Tool Only)

SKU 297319
 MAKDML806 **59⁹⁹**

- 3 LED Modes: 360° Lantern, 180° Lantern or Flashlight
- Compact and Ergonomic Design at Only 14-3/8" Tall
- Metal Hang Hook Swivels 360° and Folds Away for Added Convenience
- Rubberized Soft Grip Provides Increased Comfort on the Job



Tool Only, Does Not Include Battery or Charger

18V Shop Light

SKU 821492
 MAKDML805 **109⁹⁹**

- 18 Volt Li-Ion Cordless/ 115 VAC Corded LED Flood Light
- 2 Mode Operation Delivers Up to 750 Lumens
- LED Light Effectively Illuminates Your Work Area without the Heat of Halogen Bulbs



Tool Only, Does Not Include Battery or Charger

Tripod Light Stand

SKU 010104
 MAKGM0001381 **79⁹⁹**



Radios

12V max CXT® Li-Ion Compact Job Site Radio

SKU 434581
 MAKRM02 **54⁹⁹**

- Compatible with iPod® and MP3 Players
- Rubberized Soft Grip Handle for Comfort
- Push-Button AM/FM Digital Tuner with LCD Digital Display



Tool Only, Does Not Include Battery or Charger

18V LXT® Li-Ion Bluetooth® Job Site Speaker (Tool Only)

SKU 434600
 MAKXRM07 **114⁹⁹**

- Equipped with Bluetooth to Wirelessly Connect to Mobile Devices
- Control Panel for Easy Operation of Connected Mobile Devices
- Up to 32 Hours of Continuous Operation Using 18V LXT Battery MAKBL1850B
- Protective Bumpers are Engineered for Increased Durability
- Includes A/C Adapter (Battery and Charger Not Included)



Tool Only, Does Not Include Battery or Charger

18V Shop Radio (Tool Only)

SKU 751668
 MAKXRM04B **159⁹⁹**

- Bluetooth® Compatible
- Contains a USB Port and an Auxiliary Port
- Runs Up to 20 Hours with an 18V LXT® Li-Ion 5.0 Ah Battery



Tool Only, Does Not Include Battery or Charger

POWER TOOLS

DEWALT

BONUS TOOL OFFERS VIA MAIL-IN REBATE • OFFERS VALID APRIL 1, 2017 THROUGH JUNE 30, 2017
 All Mail-In Rebate Requests Must Be Postmarked No Later Than **JULY 15, 2017** • While Supplies Last for Rebate Form, Go to WWW.DEWALT.COM/FAQS.ASPX and Type "AUTOZONE" in the Search Field

DEWALT

BUY ANY ONE OF THE TOOLS BELOW

20V MAX* Drill Driver Kit

SKU 297318
DWTDCD771C2 **149⁹⁹**

- Compact, Lightweight Design Fits Into Tight Areas
- High Performance Motor for a Wide Range of Applications
- High Speed Transmission Delivers 2-Speeds (0-450 & 1,500 RPM)
- 1/2" Single Sleeve Ratcheting Chuck Provides Tight Bit Gripping Strength
- Ergonomic Handle Delivers Comfort and Control



20V MAX* Li-Ion Compact Drill/Driver Kit

SKU 559042
DWTDCD780C2 **219⁹⁹**

- Compact, Lightweight Design
- High Speed Transmission Delivers 2 Speeds (0-600 and 0-2,000 RPM)
- Ergonomic Handle



20V Oscillating Multi Tool

SKU 695142
DWTDCS355D1 **219⁹⁹**

- Brushless Motor
- Quick Change Accessory System
- Variable Speed Trigger
- LED Light to Illuminate Work Space



20V MAX* Li-Ion Grease Gun

SKU 559072
DWTDCG571M1 **269⁹⁹**

- Motor Delivers 10,000 Max PSI
- High-Volume Pump Pushes Up to 5.0 Oz./Min. High-Flow Applications



20V MAX* Li-Ion 3/8" Impact Wrench Kit

SKU 559059
DWTDCF883M2 **279⁹⁹**

- Compact (5.70" Front to Back), Lightweight (3.4 Lbs.) Design
- XR™ Li-Ion Batteries with Fuel Gauge



20V MAX* Li-Ion 1/2" Impact Wrench Kit

SKU 559056
DWTDCF880HM2 **299⁹⁹**

- Compact (5.70" Front to Back), Lightweight (3.4 Lbs.) Design
- 3 LED Lights with 20 Second Delay After Trigger Release
- Hog Ring Anvil



20V MAX* XR Brushless High Torque 1/2" Impact Wrench Kit with Detent Pin

SKU 850035
DWTDCF899P1 **349⁹⁹**

- 1200 Ft./Lbs. of Breakaway Torque
- Max Torque: 700 Ft./Lbs.
- Includes: (1) DCF889 - 20V MAX* XR Brushless High Torque 1/2" Impact Wrench with Detent Pin Anvil - Tool (1) DCB205 - 5.0 Ah Battery (1) Multi Voltage Charger



20V MAX* Li-Ion 1/2" High Torque Impact Wrench Kit with Detent Pin Anvil

SKU 559065
DWTDCF889M2 **359⁹⁹**

- 400 Ft./Lbs. of Maximum Torque to Perform a Wide Range of Heavy-Duty Fastening Applications
- Variable Speed Trigger with Electric Brake Provides Control



20V MAX* Li-Ion 1/2" High Torque Impact Wrench Kit

SKU 559064
DWTDCF889HM2 **369⁹⁹**

- 400 Ft./Lbs. of Maximum Torque
- Variable Speed Trigger with Electric Brake
- Hog Ring Anvil



20V MAX* Band Saw Kit

SKU 850478
DWTDCS371P1 **379⁹⁹**

- 2-1/2" Cut Capacity Cuts Up to 2" SCH 40 Pipe
- LED Work Light with 20 Second Delay
- Blade Tracking Adjustment Increases Blade Life
- Dual Bearing Blade Guide Rollers Provide Increased Durability



BUY ANY ONE OF THE TOOLS BELOW

20V Grease Gun

SKU 559071
DWTDCG571B **169⁹⁹**

- Powerful Motor Delivers 9,000 Max PSI
- High-Volume Pump Pushes up to 5.0 Oz./Min.
- Air-Bleeder Valve Assists in Pump Priming After Cartridge Changes



20V MAX* Li-Ion Compact Drill Driver/Impact Driver Combo Kit (1.5 Ah)

SKU 559076
DWTDCG412P2 **269⁹⁹**

- 1/2" Drill-Driver Features 2 Speed Transmission (0-600/0-2,000 RPM)
- 1/4" Impact Driver Features 3 LED Lights with 20 Second Delay After Trigger Release



20V MAX* Li-Ion Premium 3 Speed Drill Driver Kit (4.0 Ah)

SKU 559047
DWTDCD980M2 **299⁹⁹**

- 3 Speed All-Metal Transmission
- Heavy Duty 1/2" Metal Ratcheting Chuck with Carbide Inserts



20V MAX* Compact Reciprocating Saw Kit (5.0 Ah)

SKU 695143
DWTDCS387P1 **299⁹⁹**

- 4 Position Blade Clamp
- 1-1/8" Stroke Length



20V MAX* Li-Ion Grinder Tool Kit

SKU 559068
DWTDCG412P2 **309⁹⁹**

- 7,000 RPM Motor
- Quick-Change™ Wheel Release



20V MAX* XR Li-Ion 1/2" Brushless Compact Drill/Driver Kit

SKU 297311
DWTDCD791D2 **219⁹⁹**

- High-Speed Transmission, 2 Speed Variations
- Comfort Grip Adds Balance and Control
- LED Spotlight with 20 Minute Shutoff
- 3 Mode LED



20V MAX* Brushless Drill/Impact Kit (2.0 Ah)

SKU 850655
DWTDCD283D2 **329⁹⁹**

- Brushless Motor Delivers Up to 57% More Runtime Over Brushed
- XR Li-Ion Batteries Provide 33% More Capacity Over Standard
- 1/2" Drill/Driver Fits Into Tight Areas
- 1/4" Impact Driver is Compact



20V MAX* Li-Ion Reciprocating Saw Kit

SKU 559103
DWTDCS380P1 **279⁹⁹**

- Includes (1) DCS380 Reciprocating Saw and (1) DCB 20V MAX* XR™ Premium Li-Ion Battery (5.0 Ah)



BUY ANY ONE OF THE TOOLS BELOW

12V MAX** 1/4" Screwdriver Kit

SKU 559050
DWTDCF610S2 **119⁹⁹**

- Compact, Lightweight Design Fits Into Tight Areas
- 3 LED Lights Provide Visibility without Shadows



12V MAX** 3/8" Impact Wrench Kit

SKU 559053
DWTDCF813S2 **169⁹⁹**

- 3/8" Hog Ring Anvil
- 1150 In./Lbs. of Torque
- (3) LED Lights
- Compact, Lightweight Design



12V MAX** Cordless Li-Ion Drill Driver/Impact Driver Combo Kit

SKU 559074
DWTDC211S2 **219⁹⁹**

- DCD710 12V MAX** 3/8" Drill/Driver Features 2 Speed Transmission (0-400 and 0-1,500)
- DCF815 12V MAX** 1/4" Impact Driver Features (3) LED Lights



12V MAX** Drill/Driver/Reciprocating Combo Kit

SKU 559075
DWTDC212S2 **229⁹⁹**

- Includes (1) DCD710 12V MAX** 3/8" Drill/Driver and (1) DCS310 12V MAX* Pivot Reciprocating Saw
- Plus (2) 12V MAX** Li-Ion Batteries, Fast Charger, Belt Hook, (1) 4" 6TPI Wood Cutting Blade, (1) 4" 18TPI Metal Cutting Blade and Kit Bag



BONUS GET ITEM BELOW VIA MAIL-IN REBATE* \$89.99 VALUE!

20V MAX* LED Area Work Light (Tool Only)

SKU 695139
DWTDCLO50 **89⁹⁹**

- 3 Bright LED bulbs
- 2 Brightness Settings
- Pivoting Head
- Over Molded Lens Cover



BONUS GET ITEM BELOW VIA MAIL-IN REBATE* UP TO \$129.99 VALUE!

20V MAX* LED Area Work Light (Tool Only)

SKU 695139
DWTDCLO50 **89⁹⁹**

- 3 Bright LED bulbs
- 2 Brightness Settings
- Pivoting Head
- Over Molded Lens Cover



20V MAX* Li-Ion 3/8" Impact Wrench

SKU 559058
DWTDCF883B **129⁹⁹**

- Compact and Lightweight Design Fits into Tight Areas
- Hog Ring Anvil to Easily Change Sockets
- (3) LED Lights with 20 Second Run-Time After Trigger Release
- Textured Anti-Slip Comfort Grip Provides Maximum Comfort and Control



20V MAX* Li-Ion Compact Drill / Driver (Tool Only)

SKU 559041
DWTDCD780B **129⁹⁹**

- Chuck Size: 1/2"
- No Load Speed: 0-600/0-2000 RPM
- Includes: DCD780 1/2" Drill Driver Belt hook



BONUS GET ITEM BELOW VIA MAIL-IN REBATE* UP TO \$129.99 VALUE!

20V MAX* LED Area Work Light (Tool Only)

SKU 695139
DWTDCLO50 **89⁹⁹**

- 3 Bright LED bulbs
- 2 Brightness Settings
- Pivoting Head
- Over Molded Lens Cover



20V MAX* Compact Jobsite Blower (Tool Only)

SKU 434707
DWTDC100B **129⁹⁹**

- 100 CFM Max Air Flow
- 3-Speed Variable Switch
- Adjustable Blowing Power
- Lightweight and Compact Design



BONUS GET ITEM BELOW VIA MAIL-IN REBATE* \$39.99 VALUE!

12V MAX** LED Work Light (Tool Only)

SKU 559080
DWTDC1510 **39⁹⁹**

- Bright LED Output - 130 Lumens
- Kick Stand - Hands Free Use in Multiple Placements
- Head Rotates 360° and Pivots



* For Rebate Form, Go to WWW.DEWALT.COM/FAQS.ASPX and Type "AUTOZONE" in the Search Field.

POWER TOOLS



Contact Us:
1-877-AZTool1 Phone
 (1-877-298-6651) *Hablamos Español*

20V MAX* Heavy Duty

Li-ION TECHNOLOGY

20V MAX* Heavy Duty 1/2" Drive Li-Ion Impact Wrench
 SKU 818594 24481 **199⁹⁹**

FEATURES

- Speed: 0-2,200 RPM and 0-2,900 IPM
- Nut Busting Torque: 300 Ft./Lbs.
- Tightening Torque: 260 Ft./Lbs.



- Battery: 4.0 Ah Li-Ion
- Weight: 8 Lbs.



Rechargeable Li-Ion 20V MAX* 4.0 Ah Battery
 SKU 824772 27314A **89⁹⁹**

20V Battery Charging Station

SKU 824773 27314B **29⁹⁹**
 • Charges Both 2.0 Ah and 4.0 Ah Batteries



- Charge Time: 2 Hours
- Includes Li-Ion Battery with Charging Station

20V MAX* Heavy Duty 1/2" Drive Rechargeable Li-Ion Drill
 SKU 818593 24482 **149⁹⁹**

FEATURES

- Chuck Size: 1/2"
- 2 Speed Gear Box: 0-600 RPM and 0-2,000 RPM
- 4 Battery Light Indicators: 100% (4), 75% (3), 50% (2) and 25% (1)
- Electric Brake
- Clutch: 21 + 1 Torque Clutch Setting
- LED Work Light
- Charge Time: 1 Hour
- Includes Li-Ion Battery with Charging Station

OEM TOOLS



Rechargeable Li-Ion 20V 2.0 Ah Battery
 SKU 824777 27333A **49⁹⁹**



*With respect to 20V MAX, maximum initial battery voltage (measured without a workload) is 20 volts. Nominal voltage is 18.

NEW

20V MAX* Li-Ion 1/2" Brushless Drill
 SKU 592256 24484 **179⁹⁹**

- Chuck Size: 1/2" Keyless Jacob's Chuck
- Variable Speed: 0-600 RPM and 0-2,000 RPM
- Max. Torque: 310 In./Lbs.
- Electric Brake
- Clutch: 21 + 1 Torque Setting
- Battery: 2.0 Ah Li-Ion
- Charge Time: 1 Hour
- Weight: 7.63 Lbs.
- Includes: 20V MAX* Li-Ion 1/2" Brushless Drill, Rechargeable 2.0Ah Li-Ion Slide Battery and Charging Station



NEW

20V MAX* Li-Ion 1/2" Brushless Hammer Drill
 SKU 593469 24485 **179⁹⁹**

- Chuck Size: 1/2" Keyless Jacob's Chuck
- Variable Speed: 0-600 RPM and 0-2,000 RPM
- Max. Torque: 310 In./Lbs.
- Electric Brake
- Clutch: 21 + 1 Torque Setting
- Battery: 2.0 Ah Li-Ion
- Charge Time: 1 Hour
- Weight: 7.65 Lbs.
- Includes: 20V MAX* Li-Ion 1/2" Brushless Hammer Drill, Rechargeable 2.0Ah Li-Ion Slide Battery and Charging Station



NEW

20V MAX* Li-Ion Brushless 1/2" Impact Wrench
 SKU 592251 24486 **229⁹⁹**

- Anvil: 1/2" Square Drive
- Variable Speed: 0-2,600 RPM; 0-3,000 IPM
- Nut Busting Torque: 300 Ft./Lbs.
- Tightening Torque: 260 Ft./Lbs.
- Battery: 4.0 Ah Li-Ion
- Charge Time: 2 Hours
- Weight: 9.28 Lbs.
- Includes: 20V MAX* Li-Ion Brushless 1/2" Drive Impact Wrench, Rechargeable 4.0Ah Li-Ion Slide Battery and Charging Station



NEW

20V MAX* Li-Ion Brushless 1/4" Impact Driver
 SKU 592213 24487 **179⁹⁹**

- Drive: 1/4" Quick Release
- Variable Speed: 0-3,000 RPM; 0-3,000 IPM
- Nut Busting Torque: 300 Ft./Lbs.
- Tightening Torque: 260 Ft./Lbs.
- Battery: 2.0 Ah Li-Ion
- Charge Time: 1 Hour
- Weight: 7.17 Lbs.
- Includes: 20V MAX* Li-Ion Brushless 1/4" Drive Impact Driver, Rechargeable 2.0 Ah Li-Ion Slide Battery and Charging Station



*With respect to 20V MAX, maximum initial battery voltage (measured without a workload) is 20 volts. Nominal voltage is 18.

Rechargeable Screwdriver

4V Li-Ion Rechargeable Screwdriver
 SKU 339037 33624667 **29⁹⁹**

- 1/4" Hex Drive with Auto Lock
- No-Load Speed: 230 RPM
- Trigger Activated LED Work Light
- Toggle Switch for Easy Forward / Reverse Change
- Battery Charge Indicator Lights on Tool
- Contents: (1) 4V Cordless Screwdriver, (4) 1/4" Hex Bits and (1) Charger



20V MAX* Li-Ion Reciprocating Saw
 SKU 592353 24491 **129⁹⁹**

- Variable Speed: 0-3,000 RPM
- Length of Stroke: 1"
- Max. Cutting Capacity (Wood with 12" Blade): 3-1/8"
- Max. Cutting Capacity (Pipe): 3/4"
- Overall Length: 14-1/4"
- Battery: 2.0Ah Li-Ion
- Charge Time: 1 Hour
- Weight: 7.29 Lbs.
- Includes: 20V MAX* Li-Ion Reciprocating Saw, (1) High-Quality, Multi-Purpose Bi-Metal Reciprocating Saw Blade, Rechargeable 2.0 Ah Li-Ion Slide Battery and Charging Station



20V MAX* Li-Ion Cordless Angle Grinder
 SKU 598786 24492 **179⁹⁹**

- Speed: 0-10,000 RPM
- Max. Disc Diameter: 4-1/2"
- Spindle Thread: 5/8"
- Spindle Lock: Yes
- Battery: 4.0 Ah Li-Ion
- Charge Time: 2 Hours
- Weight: 7.97 Lbs.
- Includes: 20V MAX* Li-Ion Cordless Angle Grinder, (1) Grinding Disc, (1) Assist Handle, Rechargeable 4.0 Ah Li-Ion Battery and Charging Station



Corded Power Tools

7" Variable Speed Polisher
 SKU 592258 24496 **79⁹⁹**

- No-Load Speed: 1,000 - 3,000 RPM
- Power: 11 Amp
- Spindle Thread: 5/8"
- Spindle Lock: Yes
- Power Cord Length: 6 Ft.
- Weight: 8 Lbs.
- Includes: (1) Variable Speed Polisher, (1) Sanding Paper, (1) Sanding Pad,



- (1) Terry Bonnet,
- (1) Wool Bonnet,
- (1) Foam Piece and 6 Ft. Power Cord

NEW

14" Chop Saw
 SKU 592253 24497 **149⁹⁹**

- Power: 15 Amp
- No-Load Speed: 3,700 RPM
- Disc Diameter: 14"
- Disc Thickness: 1"
- Clamping Vise: Yes
- Arbor: 1"
- Max. Cutting Depth: 4.72" Round Pipe
- Power Cord Length: 6 Ft.
- Weight: 33 Lbs.
- Includes: 14" Chop Saw, 8 mm Hex Wrench, Cutting Blade and 6 Ft. Power Cord



NEW

Dual Temp Heat Gun
 SKU 592200 24498 **39⁹⁹**

- Powerful 1500 Watts Heating Power
- 3 Position Trigger Switch for On/Off and Temperature Setting
- Temperature: 482° F to 842° F (250° C to 450° C)
- Built-in Aluminum Stand
- 10 Piece Set Includes: Dual Temp Heat Gun, Nozzle Deflectors, 3 Interchangeable Scraper Blades, Scraper Handle, Scraper and Blow Mold Case



NEW

DID YOU KNOW?

AutoZone® carries bulk packs of mini bulbs and headlight lamps

Contact Your AutoZone Commercial Sales Manager for Details

Bench Grinder

Heavy Duty 6" Bench Grinder with Lamp
 SKU 412598 80058 **69⁹⁹**

- Solid, Heavy Duty Construction for Shaping and Sharpening Hardened Steel
- 6" Wheels with Tool Rests
- Tool Rests Adjust to 45° or 90° Position
- Includes: Coarse and Fine 6" Grinder Wheels, Goose Neck Lamp, Adjustable Eye Guards and Spark Breakers



Bench Grinder Stand
 SKU 818596 80173 **39⁹⁹**

- Works with Most Bench Grinders
- Base: 18-7/8" x 19-3/4"
- Convenient 12-1/2" x 13-3/8" Tool Tray



POWER TOOL ACCESSORIES

Screwdriver Sets

37 Piece Screwdriving Set

SKU 849592
DWTDW2163 **29⁹⁹**

- Includes Slotted Bits and Bit Tips
- 10 of the Most-Needed No. 2 Phillips Bit Tips
- Power Bits, Square Recess Bits and a Double Ended Bit
- Compact Magnetic Drive Guide
- Includes Tough Case

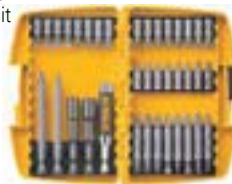

40 Piece Impact Ready[®] Screwdriving Set

SKU 850480
DWTDW2T40IR **29⁹⁹**

- FlexTorq™ Allows Bits to Flex Up to 15 Degrees
- 10X Magnetic Screw Lock System
- Minimizes Drops and Reduces Wobbling
- Reduces Breakage for Longer Life



45 Piece Screwdriving Set

SKU 850468
DWTDW2166 **34⁹⁹**

- Most Common Screwdriver Accessories
- Precise Fitment on No. 2 Phillips Bits
- Double-Ended 1" Bits
- Titanium Torsion Bits
- Includes Tough Case



80 Piece Screwdriving Set

SKU 850469
DWTDW2587 **54⁹⁹**

- 17 Black Oxide Drill Bits
- Industrial Screwdriving and Fastening Bits
- Magnetic Bit Tip Tray
- Includes Tough Case



Drill Bit Sets

14 Piece Pilot Point Industrial Cobalt Drill Bit Set

SKU 297460
DWTDW1240 **29⁹⁹**

- Designed for Maximum Speed and Life
- Pilot Point and Split Tip Design
- No Bit Walking Means More User Control
- For Use on Hard Metals



29 Piece Pilot Point Drill Bit Set

SKU 596975
DWTDW1969 **69⁹⁹**

- No-Spin Shank Eliminates Bit Spinning in the Chuck
- Gold Ferrous Oxide Coating
- Tapered Web Provides Greater Durability to Reduce Breaking
- Size Markings Located Above the Shank to Prevent Wearing Away
- Pilot Point Tips Start on Contact for Clean, Accurate Holes



21 Piece Pilot Point Titanium Drill Bit Set

SKU 297498
DWTDW1361 **34⁹⁹**

- Titanium-Coating Lasts Up to Six Times Longer Than Standard Bits
- Suitable for Drilling Through Metal, Wood, and Laminates
- No Spin Shanks
- Tapered Web Provides Greater Durability to Reduce Breaking



29 Piece Pilot Point Cobalt Drill Bit Index Set

SKU 297485
DWTDW1269 **109⁹⁹**

- Suitable for Drilling in Stainless Steel, Abrasive Metal, and Hard to Drill Alloys
- Pilot-Point Tip Starts on Contact for Clean, Accurate Holes and Reduces Lock-Up on Breakthrough
- Industrial-Strength Cobalt with Gold Ferrous Oxide Finish for Optimum Life and Durability
- Size Markings are Located Above the Shank to Prevent Wearing Away



DID YOU KNOW?

AutoZone[®] carries over 30 part numbers of Power Sport Batteries. These fit motorcycles, ATVs/UTVs, snowmobiles and personal watercraft.

Contact Your AutoZone Commercial Sales Manager for Details

Grinding Wheels

Depressed Center Hubless Grinding Wheels 4-1/2" x 1/4" x 7/8" (10 Pack)

SKU 459136
SHA12661 **29⁹⁹**

- Fits 4-1/2" Angle Grinder
- Great for Auto Body Work as Well as All Types of Metal Fabrication and Steel Finishing/Removal
- Max. RPM: 11,900



Depressed Center T27 Hub Grinding Wheels 4-1/2" x 1/4" x 7/8" - 5/8" - 11NC (10 Pack)

SKU 459155
SHA12662 **39⁹⁹**

- Fits 4-1/2" Angle Grinder with 5/8" - 11NC Arbor
- Great for Auto Body Work as Well as All Types of Metal Fabrication and Steel Finishing/Removal
- Max. RPM: 11,900



14" x 1/8" x 1" Cut-Off Wheel (5 Pack)

SKU 459158
SHA12663 **49⁹⁹**

- Use on Stationary Chop Saws
- Max. RPM: 4,400



4-1/2" x 1/4" x 7/8" Metal Grinding Wheel - (10 Pack)

SKU 850482
DWTDW4514B5 **22⁹⁹**

- Heavy Duty Cutting and Grinding of Ferrous Metals
- High Grain Concentration for Aggressive Grinding Action and Smoother Running Wheels
- 3 Full Sheets of Fiberglass for Durability and Safety
- Proprietary Aluminum Oxide Grain Combination



4-1/2" x 0.045" x 7/8" Metal Cutting Wheel - (2 Pack of 5)

SKU 850030
DWTDW8424B5 **19⁹⁹**

- Heavy Duty Cutting and Grinding of Ferrous Metals
- Thin .045" Wheel Design for Fast Burr Free Cutting
- Premium Resin Bonds Inspected Before Use
- Proprietary Aluminum Oxide Grain Combination



Reciprocating Saw Blades

4" 14 TPI Saw Blade - 5 Pack

SKU 847084
MAK723062-A-5 **19⁹⁹**

- Lasts 10X Longer Than HCS Blades
- 0.035" Blade Thickness
- For Cutting in Metal Under 1/8"
- Pack of 5



6" 14 TPI Saw Blade - 5 Pack

SKU 847080
MAK723066-A-5 **19⁹⁹**

- Lasts 10X Longer Than HCS Blades
- 0.035" Blade Thickness
- For Cutting in Metal 1/8"-3/16" Thick
- Pack of 5



9" 18 TPI Saw Blade - 5 Pack

SKU 847081
MAK723069-A-5 **19⁹⁹**

- Lasts 10X Longer Than HCS Blades
- 0.035" Blade Thickness
- For Cutting in Metal 1/8"-3/16" Thick
- Pack of 5



Metal and Wood Cutting Recip Blade Set

SKU 850474
DWTDW4856 **19⁹⁹**

- Contains 6 Blades
- (4) Metal-Cutting Blades
- (2) Wood-Cutting Blades
- Raker Tooth Design
- 6 Degree Hook Angle



Metal and Wood Cutting Recip Blade Set

SKU 850473
DWTDW4857 **19⁹⁹**

- Contains 5 Blades
- (3) Metal-Cutting Blades
- (2) Wood-Cutting Blades



8 Piece 2X Recip Blade Set

SKU 850471
DWTDW4101 **29⁹⁹**

- (3) 6" 6 TPI Recip Blades
- (3) 6" Premium Cutting Blades
- (1) 9" 10 TPI Recip Blade
- (1) 8" Premium Cutting Blade
- (1) Tough Case



Metal and Wood Cutting Recip Blade Set

SKU 850475
DWTDW4892 **29⁹⁹**

- (3) 6" Wood-Cutting Blades
- (2) 6" Metal-Cutting Blades
- (3) 8" Metal-Cutting Blades
- (3) 9" Wood-Cutting Blades
- (1) 9" Demolition Blade

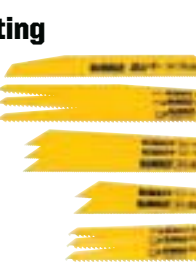

Metal and Wood Cutting Recip Blade Set

SKU 850477
DWTDW4890 **34⁹⁹**

- (5) 6 TPI Wood-Cutting Blades
- (5) 14 TPI Metal-Cutting Blades
- (5) 18 TPI Metal-Cutting Blades
- Includes Tough Case



Drill Set

38 Piece Impact Drill and Driver Set

SKU 847083
MAKT-01373 **24⁹⁹**

- (4) Black Oxide Drill Bits: 1/16", 3/32", 1/8" and 1/4"
- (3) 3-1/2" Extra Length Drill Bits
- (6) 2" Power Bits: 2-P2, 2-P3, R15 and R20
- (21) 1" Bit Tips: Slotted, Phillips, Robertson and Torx
- (1) 1/4" to 1/4" Hex to Square Adapter
- Injection Molded Case



Spiral Step Drill Set

SKU 099189
24372 **39⁹⁹**

- Titanium Coated Finish
- 28 Hole Sizes in 3 Bits
- Bit One: 13 Sizes from 1/8" to 1/2"
- Bit Two: 6 Sizes from 3/16" to 1/2"
- Bit Three: 9 Sizes from 1/4" to 3/4"



70 Piece Impact Drill-Driver Bit Set

SKU 847085
MAKT-01725 **34⁹⁹**

- Compatible with 1/4" Impact Drivers and 3/8" or 1/2" Driver/Drills
- UltraLok™ 1/4" Hex Shanks
- Magnetic 3" Bit Holder and Nut Drivers
- Black Oxide Coating to Resist Corrosion
- Compatible with Quick-Change Connector Systems



7 Piece Bolt Extractor Nut Driver Set

SKU 298210
22990 **29⁹⁹**

- Reverse Spiral Flutes for Maximum Gripping Power
- SAE Sizes: 3/16", 1/4", 3/8", 7/16", 1/2"
- Metric Sizes: 8 mm, 10 mm
- Chrome Moly Steel Construction
- Use with Impact Driver, Drill and Driver Handle



Hole Saw Set

6 Piece Bi-Metal Hole Saw Set

SKU 547011
24378 **49⁹⁹**

- Slotted Saw Allows for Easier Plug Removal
- Durable Enamel Finish Protects Against Corrosion
- Bi-Metal Construction for Increased Wear Resistance
- Sizes Included: 7/8", 1", 1-1/8", 1-1/4" and 1-1/2" (22 mm, 25 mm, 29 mm, 32 mm and 38 mm)
- Set Comes in a Blow Mold Case



Bench Grinding Wheel

6" Bench Grinding Wheel

SKU 112398
SHA2017 **14⁹⁹**

- 6" x 3/4" Wheel with 1" Arbor Hole with Reducing Bushings 1/2"-5/8"-3/4"
- 46 Grit



HEAVY DUTY



Contact Us:
1-877-AZTool1 Phone
 (1-877-298-6651) *Hablamos Español*

HD Scan Tools

Full Color Heavy Duty Truck Code Scanner with Caterpillar Coverage and OBDII

SKU 344832
 CDOHDCODEII **449⁹⁹**

- Includes CAT Power Equipment, CAT Construction and CAT Industrial, International, Hino, Isuzu and Hybrid HD Trucks Plus OBDII Vehicles
- Access Engine, Transmission and Brakes
- Read/Clear Codes
- View/Graph Live Data

Extensive Class 4-8 HD, Medium and Light Duty Truck and Caterpillar Coverage



JPRO® Professional Diagnostic Software and Adapter Kit with Next Step

SKU OUTSIDE BUY/EPO
 NRS232125-NS **3,249⁹⁹**

- JPRO® Professional Diagnostic Software (Annual Subscription)
- Next Step™ Service Information
- DLA+ 2.0 Adapter
- Type-2 Vehicle Cables (6-Pin, 9-Pin)
- Type-B OBDII Cables (Ford, GM, Sprinter, Mack and Volvo)

Connects Heavy Duty Vehicles to a PC via USB Port for Diagnostics, Reprogramming or Parameter Adjustment

Available via Outside Buy/EPO, Call 1-877-298-6651 for ordering instructions.



HD Pro II

SKU 597204
 CDOHDPROII **4,294⁹⁹**

- Read and Clear Codes, View Live Data Stream, Read System ID and Info, Activation Tests and More
- Extensive HD Coverage Including Class 4-8 Trucks and Industrial Equipment
- Powerful Special Functions: OEM-level Regenerations, Cylinder Cutout, Injector Programming, DPF Activation, Regeneration and Reset, Reset Parameters, DPF/NOX Reset, SCR/DEF Coverage, Service Resets and More
- Diesel Hybrid Access
- 8" TFT Touch Screen Color Display



JPRO® Professional Diagnostic Software and Adapter Kit

SKU OUTSIDE BUY/EPO
 NRS232125 **2,099⁹⁹**

JPRO® Professional Diagnostic Toolbox + Next Step™

SKU OUTSIDE BUY/EPO
 NRS263025-NS **4,899⁹⁹**

- JPRO® Professional Diagnostic Software (Annual Subscription)
- Next Step™ Service Information
- Panasonic Toughbook CF-53
- DLA+ 2.0 Adapter
- Type 2 Vehicle Cables (6-Pin & 9-Pin)
- Type-B OBDII Cables (Ford, GM, Sprinter, Mack and Volvo)
- USB Cable

Available via Outside Buy/EPO, Call 1-877-298-6651 for ordering instructions.



Heavy Duty MaxiSYS® Diagnostic Tablet

SKU 596888
 AULMS908CV **4,694⁹⁹**

- Performs Enhanced System Diagnostics on More Than 60 Commercial Vehicles
- 9.7" LED Capacitive Touch Screen, Android-Based Tablet
- MaxiFlash Elite, Bluetooth-Enabled VCI/J2534 Device
- WiFi and Bluetooth Enabled Tablet
- Read and Clear Codes, View and Graph Live Data
- Perform Tool-Guided Maintenance Services
- Diagnoses Manufacturer-Specific Systems Including Allison Transmissions, Bendix ABS Brake Systems, and Detroit Diesel Engines
- One-Year Software Updates



JPRO® Professional Diagnostic Toolbox

SKU OUTSIDE BUY/EPO
 NRS263025 **3,749⁹⁹**

HD Lifts

HDS-35X 35,000 Lb. Capacity Extended Length 4 Post Truck Lift

SKU OUTSIDE BUY/EPO
 BENHDS35X **18,699⁹⁹**

- Extra-Wide Runways
- Spring-Loaded Safety Locks
- Supersized 12" Diameter Cable Sheaves
- Durable Powder Coat Finish
- Max Rise: 60" (1,524 mm)
- Column Height: 93" (2,362 mm)
- Overall Width: 154" (3,912 mm)
- Overall Length: 357" (9,068 mm)

Price Does Not Include Installation or Optional Equipment as Shown



44050 50,000 Lb. 4 Post Lift with 32" Wide Runways

SKU OUTSIDE BUY/EPO
 CHL44050 **44,299⁹⁹**

- Overall Length: 36'
- Overall Width: 17' 1-1/4"
- Overall Height: 92"
- Maximum Wheelbase: 310"
- Rise Height: 73"

44050X 50,000 Lb. 4 Post Lift XL Extended Length with 32" Wide Runways

SKU OUTSIDE BUY/EPO
 CHL44050X **47,999⁹⁹**

- Overall Length: 46'
- Overall Width: 17' 1-1/4"
- Overall Height: 92"
- Maximum Wheelbase: 430"
- Rise Height: 73"

Price Does Not Include Installation or Optional Equipment as Shown

44050E 50,000 Lb. 4 Post Lift Extended with 32" Wide Runways

SKU OUTSIDE BUY/EPO
 CHL44050E **45,999⁹⁹**

- Overall Length: 41'
- Overall Width: 17' 1-1/4"
- Overall Height: 92"
- Maximum Wheelbase: 370"
- Rise Height: 73"



HD Wheel Balancers

Super-Duty Truck Wheel Balancer with Drive-Check™

SKU 255750
 RANRB24T **6,849⁹⁹**

- Shaft Size 40 mm.
- Maximum Tire Diameter 50", Max Tire Weight 400 pounds, Max. Wheel Diameter 30", Wheel Width Capacity 2" - 20"
- Includes: Centering Cones Included 5 Standard Cones / 1 Dual Tapered Cone, Wheel Calipers
- Voltage 208-240V 50/60HZ 1Ph.

Price Does Not Include Tires or Rims as Shown



Lift Gate Service
 SKU 262533
 RANLIFTGATE **135⁰⁰**

geodyna™ 980L Truck Wheel Balancer

SKU OUTSIDE BUY/EPO
 HOFEEWB710BW **11,059⁹⁹**

- Motor: 1 HP, 115VAC
- Pneumatic Wheel Lift Aids in Proper Wheel Mounting and Eliminates Need to Manually Lift Heavy Tires
- Operator Can Recalibrate the Balancer in Two Easy Steps, Ensuring Accuracy and Saving Costly Service Calls
- Semi-Automatic Parameter Entry
- Maximum Wheel Assembly Width: 25"
- Maximum Wheel Assembly Diameter: 30"
- Maximum Wheel Weight: 500 Lbs.
- Includes Automotive Cones

Price Does Not Include Tires or Rims as Shown



Lift Gate Service
 SKU 290017
 HOFLIFTGATE **95⁰⁰**

6450-3D HD Balancer

SKU OUTSIDE BUY/EPO
 AMM64503DKTIP **16,129⁹⁹**

- Dual Calibration Software Stores and Runs Two Independent Sets of Calibrations - Like Having Two Machines in One
- Powerful 1.5 HP Direct Drive Motor Shaves 20 Seconds off a Typical 22.5" Spin
- Maximum Tire Diameter: 52"
- Maximum Tire Weight: 500 Lbs.
- Designed for Front Line, High Volume Balancing, it is the Perfect Machine for Delivery Vehicles and Tractor Trailers

Lift Gate Service
 SKU 262529
 AMMLIFTGATE **55⁰⁰**



HD Tire Changers

Super-Duty Truck Tire Changer

SKU 544552
 RANR26FLT **6,399⁹⁹**

- Portable Control Unit
- Self-Centering Hydraulic Clamping Chuck
- Spreader Jaws
- Max Rim Diameter: 14" - 26"
- Max Tire Diameter: 63"
- Max Tire Width: 31-1/2"

Lift Gate Service
 SKU 262533
 RANLIFTGATE **135⁰⁰**



CHD-6330 HD Tire Changer

SKU OUTSIDE BUY/EPO
 AMM8006330 **14,424⁹⁹**

- Motor: 2 HP
- Maximum Tire Diameter: 63"
- Rim Diameter: 13" - 27"
- Four-Jaw Chuck Allows for Fast and Easy Clamping of Virtually All Rim Styles
- Features Portable Control Station
- Solid, Single Piece Frame for Added Capacity and Dependability

INCLUDES On-Site Factory Authorized Training

Lift Gate Service
 SKU 262529
 AMMLIFTGATE **55⁰⁰**

Warranty
 5 year transmission
 3 year motor 1 year standard parts
 6 months labor



Price Does Not Include Tires or Rims as Shown

DID YOU KNOW?

We carry water pump and timing component kits.

Contact Your AutoZone® Commercial Sales Manager for Details

SHOP COOLING AND AIR FANS

Barrel Fans

NEW

20" Orbital Drum Fan

- SKU 592210 **99⁹⁹**
24882
- Pivoting Ring Surround Allows Fan to Rotate Vertically and Horizontally
 - Matte Black Metal Shroud
 - 3 Aluminum Blades Produce 5100 CFM
 - 3 Speed, 1.35 Amp Motor
 - 6' UL Listed Power Cord
 - 120V/60Hz
 - Includes Brackets for Wall Mounting



Wall Mountable

24" Tilt Barrel Fan

- SKU 688216 **159⁹⁹**
24874
- 24" Tilting Barrel Fan
 - 180° Tilt
 - 2 Speed High-Efficiency Motor
 - 3 Aluminum Fan Blades
 - 9,230 CFM
 - 6' UL Listed Cord



OEM TOOLS

36" Tilt Barrel Fan

- SKU 688217 **279⁹⁹**
24875
- 36" Tilting Barrel Fan
 - 2 Speed High-Efficiency Motor
 - 3 Aluminum Fan Blades
 - 11,280 CFM
 - 6' UL Listed Cord



Wall Fans

OEM TOOLS

24" Oscillating Wall Mount Fan

- SKU 592383 **149⁹⁹**
24883
- Complete Metal Structure
 - Easy to Assemble and Mount to Wall
 - Oscillates 180 Degrees
 - 3 Aluminum Blades Produce 6500 CFM
 - 3 Speed, 2.0 Amp Motor
 - 6' UL Listed Power Cord
 - 120V/60Hz



NEW

42" Belt Driven Barrel Fan

- SKU 688203 **379⁹⁹**
24876
- Versatile 42" Barrel Fan
 - 2 Speed Belt Driven Motor
 - 15,800 CFM
 - 6' UL Listed Cord



42" Direct Drive Barrel Fan

- SKU 344969 **349⁹⁹**
24879
- 42" Barrel Fan
 - 2 Speed, Direct Drive Motor
 - 3 Blades
 - CFM: 12,700



30" Internal Orbit Wall Mount Fan

- SKU 592385 **179⁹⁹**
24884
- Complete Metal Structure
 - Easy to Assemble and Mount to Wall
 - Oscillates 180 Degrees
 - 3 Aluminum Blades Produce 9500 CFM
 - 3 Speed, 2.4 Amp Motor
 - 6' UL Listed Power Cord
 - 120V/60Hz

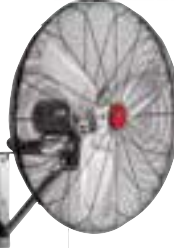

NEW

Floor Fans

NEW

18" Floor Fan

- SKU 592201 **69⁹⁹**
24881
- Complete Metal Structure with Rotary Switch on Fan Guard
 - V-Shaped Base with Pivoting Arms Allows the Fan to be Tilted
 - Rear Handle for Easy Transportation
 - 3 Black Aluminum Blades Produce 4500 CFM
 - 3 Speed, 1.05 Amp Motor
 - 5' UL Listed Power Cord
 - 120V/60Hz



SHOP SUPPLY of the MONTH
JUNE
SEE INSERT FOR DETAILS

20" Floor Fan

- SKU 688200 **74⁹⁹**
24870
- 20" High Velocity Floor Fan
 - Energy Efficient 3 Speed Motor
 - 3 Aluminum Fan Blades
 - 4,650 CFM
 - 5' UL Listed Cord



OEM TOOLS

Rolling Tilt Fans

24" Rolling Tilt Fan

- SKU 592212 **149⁹⁹**
24880
- 4" Front Wheels for Easy Mobility
 - 3 Black Aluminum Blades Produce 8600 CFM
 - 3 Speed Motor
 - 6' UL Listed Power Cord
 - 120V/60Hz



NEW

Pedestal Fans

20" Internal Orbit Fan

- SKU 688199 **99⁹⁹**
24872
- 20" Orbital Fan
 - 3 Speed High-Efficiency Motor
 - 3 Aluminum Fan Blades
 - 4,200 CFM
 - 6' UL Listed Cord



20" Oscillating Pedestal Fan

- SKU 688197 **119⁹⁹**
24871
- 20" Pedestal Fan
 - Oscillating, 3 Speed Motor
 - 5 Aluminum Blades
 - 4,200 CFM
 - 6' UL Listed Cord



30" Oscillating Pedestal Fan

- SKU 592248 **199⁹⁹**
24885
- Complete Metal Structure with Large Base
 - Oscillates 180 Degrees
 - 3 Aluminum Blades Produce 9500 CFM
 - 3 Speed, 2.4 Amp Motor
 - 6' UL Listed Power Cord
 - 120V/60Hz



NEW

30" Pedestal Fan

- SKU 688201 **199⁹⁹**
24873
- 30" Pedestal Fan
 - 3 Speed High Efficient Motor
 - 6' UL Listed Cord
 - 7,250 CFM



NEW

Blower Fans

Portable Mechanic's Fan - 300 CFM

- SKU 850064 **69⁹⁹**
24877
- For Indoor or Outdoor Use
 - 4 Position Feet
 - Great for Use in Shops, Offices, Homes and Other Locations
 - 3-Speed Switch
 - (2) 11 Amp Grounded Receptacles with Over Current Protection



Portable Mechanic's Fan - 1200 CFM

- SKU 850066 **89⁹⁹**
24878
- For Indoor or Outdoor Use
 - 4 Position Feet
 - Great for Use in Shops, Offices, Homes and Other Locations
 - 3 Speed Switch
 - (2) 11 Amp Grounded Receptacles with Over Current Protection



Evaporative Coolers

OEM TOOLS

2500 CFM 3 Speed Evaporative Cooler

- SKU 592238 **399⁹⁹**
24886
- Cools Up to 750 Square Feet
 - 1/4 HP 3-Speed Variable Motor with Automatic Shutoff
 - Large Casters for Mobility
 - Heat is Carried Away by the Evaporation of Water
 - Dimensions: 37" x 24" x 15"; Weight: 45 Lbs; Water Capacity: 10.3 Gallons



NEW

4500 CFM 3 Speed Evaporative Cooler

- SKU 592259 **499⁹⁹**
24887
- Cools Up to 1,600 Square Feet
 - 1/3 HP 3-Speed Variable Motor with Automatic Shutoff
 - Large Casters for Mobility
 - Heat is Carried Away by the Evaporation of Water
 - Dimensions: 45" x 28" x 17"; Weight: 63 Lbs; Water Capacity: 14.6 Gallons



NEW

OEM TOOLS

DID YOU KNOW?

STP oil is now available at AutoZone®. STP is a worldwide name that customers know and trust. Buy your STP oil and filters at your local AutoZone store.

Contact Your AutoZone Commercial Sales Manager for Pricing

2200 CFM 3 Speed Evaporative Cooler

- SKU 849598 **399⁹⁹**
HESMC37A
- Cools Up to 750 Square Feet
 - 3 Speed Variable Motor with Energy Efficient Electronic Timer
 - Delivers the Most Cooling CFM for Your Money - \$0.03/Hour
 - USB Port Provides Ability to Charge Phones and Accessories
 - Dimensions: 37" x 17" x 25"; Water Capacity: 10.3 Gallons Weight: 43 Lbs.



While Supplies Last

H HESSAIRE

5300 CFM 3 Speed Evaporative Cooler

- SKU 849597 **599⁹⁹**
HESMC61A
- Half the Price of Comparable Coolers
 - Cools Up to 1600 Square Feet
 - Patented Wing Prop with 3 Panels of High-Density Rigid Media Throws Cooler Air Farther
 - 3-Speed Variable Motor with Energy Efficient Electronic Timer
 - Large Casters for Mobility
 - Delivers the Most Cooling CFM for Your Money - \$0.03/Hour
 - Heat is Carried Away By the Evaporation of Water
 - USB Charging Port Provides Ability to Charge Phones & Accessories
 - Dimensions: 45" x 17" x 28"; Weight: 63 Lbs.; Water Capacity: 14.6 Gallons



While Supplies Last

H HESSAIRE

8500 CFM 2 Speed Evaporative Cooler

- SKU 019241 **1,129⁹⁹**
HESMFC18000
- Cools Up to 2,100 Square Feet
 - Uses the Natural Process of Water Evaporation to Reduce Temperatures by Up to 20 Degrees
 - Rugged Polypropylene Housing with UV Protection
 - Easy Fill Tank Holds 32.8 Gallons of Water, Enough for 3-4 Hours of Operation
 - Portable Design with 4 Extra Strength Caster Wheels
 - Less than Half the Price of the Competition



While Supplies Last

H HESSAIRE

SHOP COOLING AND AIR FANS



PORTACOOOL™ EVAPORATIVE COOLERS

AutoZone® SKU	Descriptions	Cooling (s.f.)	CFM	Velocity (mph)	Price
850515	Jetstream 270	5,625	22,500	26	\$3,699
850517	Jetstream 260	3,125	12,500	25	\$2,699
850516	Jetstream 250	2,125	8,500	24	\$2,199
850514	Jetstream 240	1,125	4,500	29	\$1,499
850513	Cyclone 3000	700	3,000	27	\$799
850053	Cyclone 2000	500	2,000	30	\$599
850512	Cyclone 1000	300	1,000	17	\$399



PORTACOOOL™

WHEN COMFORT COUNTS™

Evaporative Coolers

18" Evaporative Cooler (Variable Speed)

- Reduces Temperature By Up to 33 Degrees
- 33% More Cooling Surface Than Standard 6" Media
- Garden Hose Connection
- Housing – Constructed of Roto-Molded Corrosion Free Polyethylene
- Fan Motor – High Efficiency, Totally Enclosed 1/2 HP
- Direct Drive: 110 Volt / 1 Ph. / High 2.9 Amps / Low 1.45 Amps
- Cooling Coverage Area – Approx. 1,200 Sq. Ft.



Direct Drive Portable

- SKU 850492 **1099⁹⁹**
CLSCS5-16-VD
- Water Reservoir – Internal 16 Gallon Capacity



Tall Base

- SKU 850050 **1,399⁹⁹**
CLSCS5-16VDTB
- Water Reservoir – Internal 52 Gallon Capacity

Lift Gate Service
SKU 543687 **75⁰⁰**
CLSLIFTGATE



CTT-EC Scale Treatment Tablets

- SKU 110321 **39⁹⁹** • Protect Pads from Hard Water and Scale
CLSCS-T101



Refresh Algae Treatment Tablets

- SKU 110322 **39⁹⁹** • Prevents Hard Water and Algae from Deteriorating the Pads
CLSCS-T102

12" Evaporative Cooler (Variable Speed)

SKU 005816 **599⁹⁹**
CLSCSW-12-VD

- Reduces Temperature By Up to 20 Degrees
- Garden Hose Connection or Portable Supply Tank
- 4" Thick, High Efficiency Corrugated Media
- Tough, UV Resistant, Durable Molded Polyethylene Housing
- 110 Volt / 1 Ph. / 0.8 Amp
- Water Reservoir - Internal 10 Gallon Capacity
- Cooling Coverage - Approx. 700 Sq. Ft.



36" Evaporative Cooler (Variable Speed)

SKU 850051 **2,699⁹⁹**
CLSCS6-36-VD

- Reduces Temperature By Up to 33 Degrees
- 33% More Cooling Surface Than Standard 6" Media
- Garden Hose Connection or Portable Supply Tank
- Housing – Constructed of Roto-Molded Corrosion Free Polyethylene
- Fan Motor – High Efficiency, Totally Enclosed 1/2 HP
- Direct Drive: 110 Volt / 1 Ph. / High 6.3 Amps / Low 1.8 Amps
- Water Reservoir – Internal 46 Gallon Capacity
- Cooling Coverage Area – Approx. 3,600 Sq. Ft.



36" Cooler Cover

SKU 005901 **299⁹⁹**
CLSCSCOVER366

- Made of Durable, 100% Polyester Fabric with Polyurethane Backing
- Water Repellent Finish Allows Maximum Defense from the Elements
- Fitted Design for 36" Cooler

36" Evaporative Cooler (Single Speed)

SKU 850052 **1,999⁹⁹**
CLSCS6-36-1D

- Reduces Temperature By Up to 33 Degrees
- 33% More Cooling Surface Than Standard 6" Media
- Garden Hose Connection or Portable Supply Tank
- Housing – Constructed of Roto-Molded Corrosion Free Polyethylene
- Fan Motor – High Efficiency, Totally Enclosed 1/2 HP
- Direct Drive: 110 Volt / 1 Ph. / 6.0 Amps
- Water Reservoir – Internal 46 Gallon Capacity
- Cooling Coverage Area – Approx. 2,900 Sq. Ft.



48" Evaporative Cooler (2 Speed)

SKU 110318 **3,599⁹⁹**
CLSCS5-48-2B

- Reduces Temperature By Up to 33 Degrees
- 33% More Cooling Surface Than Standard 6" Media
- Garden Hose Connection or Portable Supply Tank
- Housing – Constructed of Roto-Molded Corrosion Free Polyethylene
- Fan Motor – High Efficiency, Totally Enclosed 1 HP
- Direct Drive: 110 Volt / 1 Ph. / High 9.6 Amps / Low 5.8 Amps
- Water Reservoir – Internal 64 Gallon Capacity
- Cooling Coverage Area – Approx. 4,700 Sq. Ft.



48" Cooler Cover

SKU 005890 **349⁹⁹**
CLSCS-COVER48

- Made of Durable, 100% Polyester Fabric with Polyurethane Backing
- Water Repellent Finish Allows Maximum Defense from the Elements
- Fitted Design for 48" Cooler

HVLS FANS

“Big” HVLS Fans from EnergyLogic redistribute warm air to lower your heating bill.

MODEL	BLADE DIAMETER	# BLADES	AVAILABLE BLADE LENGTHS	CFM	INDUSTRY SPACING	SKU	PART NO.	PRICE
AVD 370	12 ft.	6	6 to 12 ft.	54,000 CFM	48 ft.	012679	ENLELO6000875	\$3,399.99
AVD D3	12 ft.	3	10 to 24 ft.	84,000 CFM	60 ft.	012669	ENLELO6000948	\$4,399.99
AVD 550	18 ft.	6	8 to 18 ft.	181,000 CFM	95 ft.	012701	ENLELO6000887	\$5,899.99
AVD 780	24 ft.	6	20 to 24 ft.	346,000 CFM	115 ft.	338826	ENLELO6000891	\$6,649.99

Includes fan, mounting hardware, Cat 5 cable, digital touchscreen controller and 50K hour warranty.

energylogic™

SHOP EQUIPMENT

Inverter Generators

ix800 Watt Gas Powered Inverter

- SKU 568401 GENIX800 **319⁹⁹**
- 850 Watt Peak and 800 Watt Running Power Provides Reliable Power to Run Household Appliances, Camping Equipment and More
 - 1.5 Gallon Fuel Tank Runs the Generator Continuously for Approximately 3-1/2 Hours
 - 38 cc Engine Runs on Gasoline to Provide Dependable Power
 - Two 5-15R Outlets Provide Consistent Output with Less Than 3% Total Harmonic Distortion
 - Automatic Shut-Off When Oil Levels are Low to Help Prevent Engine Damage

GENERAC



CARB Compliant

ix2000 Watt Gas Powered Inverter

- SKU 568396 GENIX2000 **589⁹⁹**
- 2,200 Watt Peak and 2,000 Watt Running Power
 - Clean Power for Consistent Output with Less Than 3% Total Harmonic Distortion is Ideal for Sensitive Electronic Devices Such as Computers and DVD Players
 - Digital Inverter Module Converts DC to AC

GENERAC



Not Available for Sale in California

2000 Watt Stackable Inverter Generator

- SKU 020739 CHM735361 **599⁹⁹**
- Run/Start Watts 1700/2000
 - Clean Power (<3% THD) - Clean Electricity for Powering Sensitive Electronics
 - Operates at 53 dBA from 23 Feet
 - Runs Up to 9.5 Hours on a Full Tank of Gas
 - Parallel Capability - Connect with Another Inverter for Increased Power
 - Space Saving Stackable Design with Carrying Handles

CHAMPION



CARB Compliant

Gas Powered Generators

3500 Watt Portable Generator

- SKU 020730 CHM46596 **379⁹⁹**
- Run/Start Watts 3500/4000
 - RV Ready - Equipped with a Standard 30A RV Outlet
 - Volt Guard Protects Your Appliances from Power Surges
 - Runs Up to 12 Hours on a Full Tank of Gas
 - Durable Steel Frame
 - 49 State EPA Compliant



CARB Compliant

GP3250 Portable Generator

- SKU 973238 GENG3250 **439⁹⁹**
- Rated Watts: 3,250
 - Runtime at 1/2 Load: 9.7 Hours
 - Outlets: (1) 120V 20A 5-20R Duplex Outlet; (1) 120/240V 20A L14-20R Twist-Lock Outlet
 - Gas Tank: 3.5 Gallons
 - Low Oil Level Shutdown Automatically Safeguards Engine

Not Available for Sale in California

CARB Models Available

GENERAC



6500 Watt Portable Generator

- SKU 020745 CHM100109 **729⁹⁹**
- Run/Start Watts 6500/8125
 - Volt Guard - Protects Your Appliances from Power Surges
 - Intelli-Gauge to Monitor Power Output and Maintenance Intervals
 - Runs Up to 11 Hours on a Full Tank of Gas
 - GFCI Protected Outlets with Covers
 - 120/240V Operation



CARB Compliant

GP15000 Gas Powered Portable Generator

- SKU 568403 GENGPI5000E **2,399⁹⁹**
- 16 Gallon Fuel Tank Runs the Generator Continuously Up to 10 Hours at Half Load; Idle Control for Improved Fuel Efficiency
 - OHVI Engine is Designed for Extended Runtimes for Use at Jobsites or for an Emergency Backup Power Source
 - Circuit Breaker Protected Outlets for Added Safety

Not Available for Sale in California

CARB Models Available

GENERAC



Not Available for Sale in California

Gas Powered Electric Start Generators

GP6500E Gas Powered Portable Electric Start Generator

- SKU 568402 GENG6500E **899⁹⁹**
- Generac's 389 cc OHV Engine with Splash Lubrication Provides a Long Engine Life
 - Low Oil Shutdown Automatically Safeguards Engine from Damage
 - Hour Meter Tracks Maintenance Intervals

Not Available for Sale in California



7500 Watt Portable Electric Start Generator

- SKU 020758 CHM100219 **949⁹⁹**
- Run/Start Watts 7500/9375
 - Touch Start - Battery Included for Push Button Electric Start
 - 25' Power Cord Included
 - Volt Guard Protects Your Appliances from Power Surges
 - Runs Up to 8 Hours on a Full Tank of Gas
 - Intelli-Gauge to Monitor Power Output and Maintenance Intervals

Not Available for Sale in California

CHAMPION



CARB Compliant

GP7500E Watt Gas Powered Portable Electric Start Generator

- SKU 568404 GENG7500E **999⁹⁹**
- Ergonomic Fold-Down Locking Handle to Make Transport and Storage Easy
 - Covered Circuit Breaker Protected Outlets Provide Added Protection from the Environment and Rugged Working Conditions
 - Electric Start with Recoil Backup Battery Included

Not Available for Sale in California

GENERAC



XG7000E Portable Electric Start Generator

- SKU 432330 GENXG7000E **1,269⁹⁹**
- Rated Watts: 7,000
 - Runtime at 1/2 Load: 12 Hours
 - Outlets: (2) 120V 20A GFCI 5-20R Duplex Outlets; (1) 120/240V 30A L14-30R Twist-Lock Outlet
 - Gas Tank: 9 Gallons
 - Low Oil Level Shutdown Automatically Safeguards Engine
 - PowerBar™ Easily Monitors Power Being Consumed and Available

Not Available for Sale in California



XG8000E Portable Electric Start Generator

- SKU 462986 GENXG8000E **1,369⁹⁹**
- Rated Watts: 8,000
 - Runtime at 1/2 Load: 10 Hours
 - Outlets: (1) 120/240V 30A L14-30R Twist-Lock Outlet; (2) 120V 20A GFCI 5-20R Duplex
 - Includes: First Oil and Maintenance Kit
 - Gas Tank: 9 Gallons
 - Low Oil Level Shutdown Automatically Safeguards Engine
 - PowerBar™ Easily Monitors Power Output and Available

Not Available for Sale in California

GENERAC



CARB Models Available

9200 Watt Portable Electric Start Generator

- SKU 020759 CHM100110 **1,099⁹⁹**
- Run/Start Watts 9200/11500
 - 459cc - CARB Compliant for Use in All 50 States
 - Touch Start - Push-Button Electric Start and Battery Maintenance Smart Charger
 - Equipped with a Standard 50A RV Outlet
 - Volt Guard Protects Your Appliances from Power Surges
 - Runs Up to 10 Hours on a Full Tank of Gas
 - Intelli-Gauge to Monitor Power Output and Maintenance Intervals

CARB Compliant



XG10000E Gas Powered Portable Electric Start Generator

- SKU 568407 GENXG10000E **2,099⁹⁹**
- User Friendly Controls (Including the Start/Stop, Fuel Shut-Off and Choke) are Conveniently Located on an Illuminated Control Panel
 - Track How Much Power You are Using and How Much Power You Have to Spare with PowerBar™
 - Covered Outlets Provide Added Protection from the Environment and Can Stand Up to Rugged Working Conditions

Not Available for Sale in California

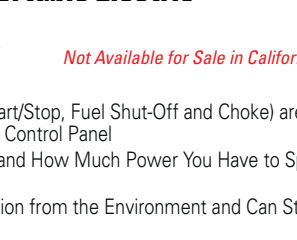

GP17500E Gas Powered Portable Electric Start Generator

- SKU 626138 GENGPI7500E **2,699⁹⁹**
- 16 Gallon Fuel Tank Runs the Generator for Up to 10 Hours at Half Load
 - 992 cc Engine Runs on Gasoline to Provide Dependable Power
 - Circuit Breaker Helps Protect the Generator and Connected Appliances from Damage

Not Available for Sale in California

GENERAC



GP17500E Gas Powered Portable Electric Start Generator

- SKU 626138 GENGPI7500E **2,699⁹⁹**
- 16 Gallon Fuel Tank Runs the Generator for Up to 10 Hours at Half Load
 - 992 cc Engine Runs on Gasoline to Provide Dependable Power
 - Circuit Breaker Helps Protect the Generator and Connected Appliances from Damage

Not Available for Sale in California

GENERAC



Propane Powered Generators

3800 Watt Dual Fuel Electric Start Generator

- SKU 020777 CHM76533 **599⁹⁹**
- Run/Start Watts 3800/4750 (Gasoline)
 - Runs on Gas or Propane Straight Out of the Box
 - Touch Start - Battery Included for Push-Button Electric Start
 - Equipped with a Standard 30A RV Outlet
 - Volt Guard Protects Your Appliances from Power Surges
 - Runs Up to 9 Hours on a Full Tank of Gas or 10.5 Hours on a 20 Lb. Propane Tank

CARB Compliant



7500 Watt Dual Fuel Electric Start Generator

- SKU 020752 CHM100165 **1,049⁹⁹**
- Run/Start Watts 7500/9375 (Gasoline)
 - Runs on Gas or Propane Straight Out of the Box
 - Touch Start - Battery Included for Push-Button Electric Start
 - Volt Guard Protects Your Appliances from Power Surges
 - Runs Up to 8 Hours on a Full Tank of Gas or 5.5 Hours on a 20 Lb. Propane Tank
 - Intelli-Gauge to Monitor Power Output and Maintenance Intervals

CARB Compliant



Hot Water Pressure Washers

HSE 1500 PSI 2.0 GPM

- SKU 597218 MTMHSE15020MM **2,799⁹⁹**
- Features a Top-Fired Heat Exchanger and Totally Enclosed, Fan-Cooled Electric Motor
 - Pump Features a High Pressure Detergent Injector
 - Temperature Rise: 150°F (66°C); Max Outlet Temperature: 200°F
 - Unit Includes: (4) Quick Connect Nozzles, 50' x 3/8" Wire-Braided High Pressure Hose, Insulated Trigger Gun with Safety Lock and Adjustable Pressure Insulated Dual Lance
 - 35 Foot Power Cord
 - CSA Certified - US and Canada

NEW



HSP 3500 PSI 3.3 GPM

- SKU 597220 MTMHSP35043MH **4,299⁹⁹**
- Burner Utilizes a Patented Electro Magnetic Firing (EMF) System, Eliminating the Need for a 12V Battery
 - Pump Features a Low Pressure Detergent Injector
 - Temperature Rise: 150°F (66°C); Max Outlet Temperature: 200°F
 - Unit Includes: (4) Quick Connect Nozzles, 50' x 3/8" Wire-Braided High Pressure Hose, Insulated Trigger Gun with Safety Lock and Adjustable Pressure Insulated Dual Lance
 - CSA Certified - US and Canada

NEW



SHOP EQUIPMENT

Pressure Washers

2,500 PSI Residential CARB Compliant Pressure Washer

- SKU 005721 GEN6921 **299⁹⁹**
- Powerful Generac Horizontal Shaft OHV Engines Feature Low Oil Shutdown, Engine Oil is Included
 - Easy Access Axial Cam Pump Means No More Kneeling on the Ground to Make Hose Connections
 - Ergonomic Generic Spray Guns with Soft Grip and Easy-to-Pull Trigger Reduces Fatigue
 - 25' PVC Hose

CARB Compliant



2,800 PSI Residential CARB Compliant Pressure Washer

- SKU 005718 GEN6922 **349⁹⁹**
- Powerful Generac Horizontal Shaft OHV Engines Feature Low Oil Shutdown, Engine Oil is Included
 - Easy Access Axial Cam Pump Means No More Kneeling on the Ground to Make Hose Connections
 - Ergonomic Generic Spray Guns with Soft Grip and Easy-to-Pull Trigger Reduces Fatigue
 - 25' PVC Hose

CARB Compliant



3,100 PSI Residential CARB Compliant Pressure Washer

- SKU 005720 GEN6923 **399⁹⁹**
- Powerful Generac Horizontal Shaft OHV Engines Feature Low Oil Shutdown, Engine Oil is Included
 - Easy Access Axial Cam Pump Means No More Kneeling on the Ground to Connect Hoses
 - Ergonomic Generac Spray Guns with Soft Grip and Easy-to-Pull Trigger Reduces Fatigue
 - 30' PVC Hose

CARB Compliant



3,100 PSI Commercial Pressure Washer

- SKU 570165 GEN6590 **649⁹⁹**
- Powerful Generac OHV Horizontal Shaft Engine Features Low Oil Shutdown
 - Professional Grade Triplex Pump with Ceramic-Coated Pistons Designed for Longer Life
 - Pressure Control Valve Provides Complete Control of Water Pressure for All Applications
 - 5/16" x 35' Hose

These Units are Not for Sale in California, Call for Pricing on CARB Compliant Models



3,800 PSI Commercial Pressure Washer

- SKU 570262 GEN6564 **749⁹⁹**
- Pro-Grade Triplex Pump Up to 4X Longer Life Than Axial Cam Pumps
 - Powerful 302 cc Generac OHV Engine Delivers Maximum Cleaning Performance and Reliability
 - Low Oil Shutdown Sensor Safeguards the Engine
 - 3/8" x 35' Steel Reinforced Rubber Hose

These Units are Not for Sale in California, Call for Pricing on CARB Compliant Models



4,200 PSI Commercial Pressure Washer

- SKU 570263 GEN6565 **899⁹⁹**
- Powerful 420 cc Generac Horizontal Shaft Engine with Low Oil Shutdown
 - Professional Grade Triplex Pump with Ceramic Coated Pistons, Designed for Long Life
 - Pressure Control Valve Provides Complete Control of Water Pressure
 - 3/8" x 50' Steel Reinforced Rubber Hose

These Units are Not for Sale in California, Call for Pricing on CARB Compliant Models



Vacuums

Available via Outside Buy/EPO, Call 1-877-298-6651 for ordering instructions.

Kubota® 5 Gallon Wet/Dry Vacuum

- SKU OUTSIDE BUY/EPO KUB54101 **69⁹⁹**
- This Stainless Steel Vacuum Comes Complete with All Accessories Needed to Get Your Next Household Job Done
 - Swiveling Casters Provide Ease of Movement in Any Direction
 - Includes Accessories: 5 Ft. Flexible Hose, 3 Extension Wands, Crevice Nozzle, Sofa / Seat Brush, Floor Brush with Switch, Wet Sponge Filter, Non-Woven Reusable Dry Filter, Dust Bag



Kubota® 8 Gallon Wet/Dry Vacuum

- SKU OUTSIDE BUY/EPO KUB54102 **99⁹⁹**
- This 8 Gal Stainless Steel Vacuum is Perfect for the Garage, House or Office
 - Lock-On Hose System
 - Includes Accessories: 7 Ft. Flexible Hose, 2 Extensions Wands, Crevice Nozzle, Sofa / Seat Brush, Floor Brush with Switch, Wet Sponge Filter, Dry Cartridge Filter, Dust Bag



Kubota® 14.5 Gallon Leaf Blower Wet Vacuum

- SKU OUTSIDE BUY/EPO KUB54104 **139⁹⁹**
- Multi-Functional Large 14.5 Gallon Drum with a Convenient Handheld Blower with Wand to Perform Any Job
 - Poly Tank
 - Includes Accessories: 5 Ft. Extra Large Hose, 2 Extra Wide Extension Tubes, Accessory Adaptor, Wet Floor Brush, Hepa Filter, Crevice Tool and Blower Tube



Kubota® 12 Gallon Wet/Dry Vacuum

- SKU OUTSIDE BUY/EPO KUB54103 **149⁹⁹**
- This Large 12 Gallon Stainless Steel Push Vacuum Will Ensure All Your Large Jobs Get Done on Time
 - Stainless Steel Tank
 - Includes Accessories: 7 Ft. Flexible Hose, Metal Extension Tube, Floor Brush with Switch, Crevice Nozzle, Dry Cartridge Filter and Wet Sponge Filter



Kubota® 3 Pack Vacuum Filter Bags

- SKU OUTSIDE BUY/EPO KUB54100 **14⁹⁹**
- Multi-Fit Disposable Filter Bag is Designed for Use with 4-12 Gallon Kubota Wet/Dry Vacuums



WASTE OIL HEATERS // **energylogic**

LOWEST PRICES OF THE YEAR ON THE PURCHASE OF A COMPLETE SYSTEM Call today for sizing help!

*Includes Waste Oil Furnace and 250 Gallon Tank, Swing-Away Burner with Built-in Air Compressor, Low-fuel Cut Off, Draft Gauge, Fuel Gauge, Drain Valve and Class A Flue Kit.



Class A Flue Kit pictured above.

COMPLETE SYSTEMS*					
250 GALLON TANK					
FURNACE	BTUs	HEATS UP TO	SKU	PART NO.	PRICE
EL-140	140,000	3,500 Sq. Ft.	850048	ENL01140103	\$5,999.99
EL-200	200,000	5,000 Sq. Ft.	850047	ENL01200104	\$6,899.99
EL-350	350,000	8,500 Sq. Ft.	850049	ENL01350104	\$8,999.99

FURNACES ONLY					
FURNACE	BTUs	HEATS UP TO	SKU	PART NO.	PRICE
EL-140	140,000	3,500 Sq. Ft.	012654	ENLEL01140101	\$5,349.99
EL-200	200,000	5,000 Sq. Ft.	012653	ENLEL01200101	\$6,164.99
EL-350	350,000	8,500 Sq. Ft.	012656	ENLEL01350101	\$8,214.99



It Just Makes Cents

1 gallon of used oil is equal to 1 hour of free heat.



Onboard Air Compressor

You don't need to hook up shop air to our furnaces.



Burn More Fuels

Uses the widest range of oils, including synthetics.



Get Warmer Faster

Our hotter flame produces double the heat rise.



Free Delivery

Delivered free to all 48 continental United States.

Exhaust Hoses



Crushproof Flarelock Hoses

- Made Exclusively for Cars and Small Trucks
- End is Flared to Permit Connection of Two or More Links at a Time

2.5" x 11' SKU 977557 ACSFLT250 **129⁹⁹**

3" x 11' SKU 977559 ACSFLT300 **149⁹⁹**

3.5" x 11' SKU 977589 ACSFLT350 **199⁹⁹**

4" x 11' SKU 977590 ACSFLT400 **239⁹⁹**

Crushproof 2.5" Y-Assembly Kit with F250 Adapter

SKU 977549 ACSYA250 **184⁹⁹**

- Designed for Connecting a Single Hose to Vehicles with Dual Exhaust Systems



3" Y-Assembly Kit with F300 Adapter

SKU 977550 ACSYA300 **219⁹⁹**

Crushproof 2.5" Service Station Kit

SKU 977547 ACSOSS25 **269⁹⁹**

Includes:

- (2) Each - 4' x 2-1/2" Hoses
- (1) Each - 6' x 2-1/2" Hose
- (1) Each - 2-1/2" Rubber "Y" Connector
- (2) Each - Straight Tailpipe Adapter, Hook and Chain
- (1) Each - Splice Connector

3" Service Station Kit

SKU 977548 ACSOSS30 **319⁹⁹**



Crushproof Door Port for 2-1/2" Hose (Rubber)

SKU 977551 ACSDF25 **39⁹⁹**

- Rubber Garage Door Port Adapter
- Designed for 2-1/2" ID



Crushproof Door Port for 3" Hose (Aluminum)

SKU 977552 ACSADF30 **49⁹⁹**

- Aluminum Port Allows Hose to Be Vented Through the Door



Crushproof Door Port for 4" Hose (Aluminum)

SKU 977554 ACSADF40 **69⁹⁹**



Crushproof Bell Hose Adapters

- Designed for Easy Adapting to All Sorts of Tailpipes
- Connects with Ball and Snap

2-1/2" Adapter SKU 977544 ACSRA250 **49⁹⁹**



3" Adapter SKU 977545 ACSRA300 **49⁹⁹**



Crushproof Straight Tailpipe Adapters with Hook and Chain

- Designed for Easy Adapting to All Sorts of Tailpipes

2.5" Straight Tailpipe Adapter with Hook and Chain.....SKU 977591 ACSF250.....	29⁹⁹
3" Straight Tailpipe Adapter with Hook and Chain.....SKU 977539 ACSF300.....	39⁹⁹
3.5" Straight Tailpipe Adapter with Hook and Chain.....SKU 977540 ACSF350.....	59⁹⁹
4" Straight Tailpipe Adapter with Hook and Chain.....SKU 977541 ACSF400.....	74⁹⁹
3" x 6" Oval Tailpipe Adapter.....SKU 977542 ACSF475.....	54⁹⁹
3.5" x 8.5" Oval Tailpipe Adapter.....SKU 977543 ACSF575.....	64⁹⁹



Contact Us:
1-877-AZTool1 Phone
 (1-877-298-6651) *Hablamos Español*

Parts Washers

OEMTOOLS® Parts Washers are a New Generation of Water-Based Parts Washers Providing All the Cleaning Power of Solvent While Using Cleaning Solutions That are Safe and Biodegradable.

Bench Top Gallon Parts Washer

- SKU 300128 **69⁹⁹**
24800
- Water-Based Parts Washer with 325 Gallon per Hour Electric Pump
 - Steel Work Basin is 18"(L) x 13.5"(W) x 9"(H)

Replacement Washer Pump
 SKU 462484 **39⁹⁹**
 24800-12

- Fits OEMTOOLS® 24800 and OEMTOOLS® 24801 Water-Based Parts Washer



Mobile Parts Washer

- SKU 546660 **129⁹⁹**
24804
- Solution Capacity (Gallons): Min. 2 - Max. 4
 - Use with Water Works™ Heavy-Duty Degreaser Concentrate
 - Not for Petroleum Based Solvents
 - Weight: 11 Lbs.
 - Dimensions: 26"(L) x 18"(W) x 9.5"(H)

Lid has Positive Seal and Latches for Mobility



20 Gallon Parts Washer

- SKU 300117 **179⁹⁹**
24801
- Water-Based Parts Washer with 325 Gallon per Hour Electric Pump
 - Steel Work Basin is 31"(L) x 21"(W) x 34.5"(H)
 - Lid Includes Fusible Link for Fire Safety

Replacement Washer Pump
 SKU 462484 **39⁹⁹**
 24800-12

- Fits OEMTOOLS® 24800 and OEMTOOLS® 24801 Water-Based Parts Washer



40 Gallon Parts Washer

- SKU 300118 **279⁹⁹**
24803
- Use with Non-Flammable, Water-Based Degreaser or Cleaning Agent
 - Fully Flexible Nozzle and Fusible Link Which Automatically Closes the Lid in Case of Fire
 - Dimensions: 44.75"(L) x 20.5"(W) x 35"(H)

Replacement Washer Pump
 SKU 462476 **39⁹⁹**
 24803-31

- Fits OEMTOOLS® 24803 Water-Based Parts Washer



Atlasta™ Parts Cleaning Brush

- SKU 342339 **19⁹⁹**
PBC50003
- A Tough Brush That Will Last and Last
 - Length: 9.75" (25 cm)



Oriflo Flow-Through Parts Brush

- SKU 342336 **24⁹⁹**
PBC50001
- Long Lasting, Stiff Trialoy® Polyester Filament Can Be Used with Either Petroleum or Water-Based Cleaning Solutions
 - Length: 10.25" (26 cm)



Flow-Through Brush with Hose

- SKU 459114 **26⁹⁹**
PBC50001H
- Oriflo Flow-Through Parts Washer Brush and High Quality Hose to Connect to Your Parts Washer



Parts Brush Division

Air Operated Sprayer

- SKU 222507 **49⁹⁹**
LIN5983
- 1/4" NPT (F) Inlet
 - Max. Operating Pressure: 150 PSI
 - Can Be Used with Solvents or Detergent Solutions



LINCOLN

EcoMaster Heated Aqueous Portable Brake Washer

- SKU 479988 **999⁹⁹**
FOU61840-02
- Heavy Duty Air Pump
 - Heavy Duty Drum Dolly with Two Locking Casters and Two Regular Casters
 - Pre-filter Screen and Asbestos Sock Filter Designed to Ensure Clean Solution
 - Heater: 1,000W - Thermostatically Controlled to Hold at 115° F
 - Sink Dimensions: 24"(L) x 20"(W) x 7"(D)



FOUNTAIN INDUSTRIES, LLC

16 Gallon Solvent Parts Washer

- SKU 479979 **449⁹⁹**
FOU62125-01
- Removable Screen Filter for Pump Protection
 - Flow Through with Adjustable Fluid Control
 - Galvanized Drawn Sink Means No Leaks
 - Inside Sink Dimensions: 31"(L) x 21"(W) x 9"(D)



CLEANMASTER

30 Gallon CleanMaster Solvent Parts Washer

- SKU 479981 **759⁹⁹**
FOU54821-01

Includes Drum

12 Gallon CleanMaster Low-Profile Solvent Brake Parts Washer

- SKU 479982 **749⁹⁹**
FOU57429-01
- Flow-Through Brush System for Efficient Cleaning
 - Durable, Baked-On Powder Coated Epoxy Finish
 - Easy-Roll Swivel Casters (2 Locking)



CLEANMASTER

EcoMaster Heated Aqueous Parts Washer

- SKU 479983 **1,449⁹⁹**
FOU61330-02
- Capacity: 45 Gallons
 - Heater Thermostatically Controlled Preset to 110° F
 - Filter System Prolongs Fluid Life



FOUNTAIN INDUSTRIES, LLC

Molded Cart for EcoMaster Heated Aqueous Parts Washer

- SKU 479985 **249⁹⁹**
FOU61332
- 500 Lbs. Capacity
 - High Density Polyethylene Molded Tray



Heavy Duty Degreaser Concentrate

- 5 Gallons (1) 5 Gallon Container
 SKU 227558 **149⁹⁹**
 WWSD-5G
- Designed to Effectively Replace Hazardous Solvent in Water-Based Parts Washers
- Concentrated to Be Powerful and to Save You Money
 - Quickly Removes Grease, Oil, Carbon and Grime While Safe for the Technician



WATER WORKS

Storm Ultra Spray Wash Solution

- 5 Gallons (1) 5 Gallon Container
 SKU 227559 **169⁹⁹**
 WWSU-5G
- Professional Wash Solution for Heated Spray Cabinet/Jet Cabinet Style Parts Washing Equipment
 - Super Concentrated for Cost Effectiveness
 - Quickly Blasts Away Grease, Oil, Carbon and Grime



WATER WORKS

Vises

OEM TOOLS

4-1/2" Light Duty Bench Vise with Swivel Base

- SKU 751645 **39⁹⁹**
24216
- Machined Replaceable Steel Jaws
 - Machined Anvil, Permanent Pipe Jaws
 - Full 360° Swivel Base
 - Clamping Strength: 100 Lbs.

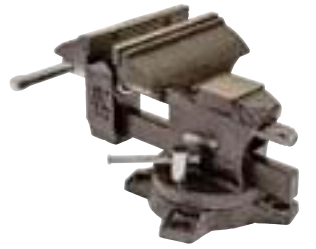

4" Heavy Duty Bench Vise with Swivel Base

- SKU 751643 **49⁹⁹**
24217
- REG. \$69.99
- Machined Replaceable Steel Jaws
 - Machined Anvil, Permanent Pipe Jaws
 - Full 360° Swivel Base
 - Clamping Strength: 200 Lbs.

SAVE \$20



Offer Good Through June 30, 2017 - While Supplies Last

6" Heavy Duty Bench Vise with Swivel Base

- SKU 751654 **99⁹⁹**
24218
- Machined Replaceable Steel Jaws
 - Machined Anvil, Permanent Pipe Jaws
 - Full 360° Swivel Base
 - Clamping Strength: 300 Lbs.



Drill Presses

OEM TOOLS

5 Speed Bench Drill Press

- SKU 462480 **139⁹⁹**
24825
- 1/2" Chuck Capacity
 - 1/3 HP, 120V, 2.3 Amp
 - 2" Stroke
 - 620 - 3,100 RPM
 - 8" Swing
 - 1/2" Max. Drilling Capacity
 - Threaded Depth Lock; Screwdriver Handle
 - 6-5/8" x 6-9/16" Table
 - 11-5/8" x 7-1/3" Base
 - 7" (W) x 16-15/16" (D) x 22-1/2" (H) Overall



16 Speed 15" Heavy Duty Floor Drill Press

- SKU 462481 **499⁹⁹**
24826
- 5/8" Chuck Capacity
 - 1 HP, 110VAC, 12 Amp
 - 3-1/64" Stroke
 - 240 - 3,200 RPM
 - 15" Swing
 - 3/4" Max. Drilling Capacity
 - Threaded Depth Lock; Screwdriver Handle
 - 12" x 12" Table
 - 17-15/16" x 10-5/8" Base
 - 15" (W) x 25-1/3" (D) x 63-1/3" (H) Overall



Abrasive Blasting

SHARK USA

Glass Bead Coarse Media, 25 Lbs.

- SKU 010136 **49⁹⁹**
SHA13077
- Ideal for Many Uses
 - Prevents Surface Rust
 - Paint and Body Applications
 - For Use with OEM 24815 Abrasive Blast Cabinet



Glass Bead Medium Grit Media, 25 Lbs.

- SKU 010139 **49⁹⁹**
SHA13078

Abrasive Blast Cabinet (Bench Top)

- SKU 300119 **179⁹⁹**
24815
- Easily Remove Paint, Rust and Oxidation
 - Fits on Bench or Cabinet
 - Dimensions: 19.3"(H) x 19.3"(W)
 - Cubic Inches: 28.6"



OEM TOOLS

SHOP EQUIPMENT

Welding/Cutting

*TIG welding requires purchase of THEW4013802 Accessory Kit

MST 140i Welder
SKU 688017
THE1444-0870 **749⁹⁹**

- Includes: Firepower MST 140i Power Supply, Firepower 140 Amp MIG Gun, Firepower Argon/CO² Pressure Regulator/Gauge and Hose, Electrode Holder and Ground Clamp, Drive Roll and Contact Tips, 15-20 Amps Power Adapter, Shoulder Strap and Multi-Language Instructional CD



MST 180i Welder
SKU 688020
THE1444-0871 **999⁹⁹**

- Includes: Firepower MST 180i Power Supply, Firepower 180 Amp MIG Gun, Firepower Argon/CO² Pressure Regulator/Gauge and Hose, Electrode Holder and Ground Clamp, Drive Roll and Contact Tips, Standard 230V Plug, Shoulder Strap and Multi-Language Instructional CD



Plasma Cutter CUTMASTER® 42
SKU 301766
THE1-4200 **1,399⁹⁹**

- Includes: CUTMASTER 42 Power Supply, All New SL40 Torch, Safety Gloves and Glasses, Instructional Plasma Cutting DVD, Consumables Set, Heavy Duty Carrying Case and Power Plug Adapters



BONUS

WITH MAIL-IN REBATE
Rebate Form Available at
www.firepoweronline.com

Welding Cart
SKU 849600 | Part# THE1444-0900
VALUE: \$139.99

Offer Good Through
June 30, 2017
While Supplies Last

with Purchase of:
**MST 140i Welder, MST 180i Welder
or Plasma Cutter CUTMASTER 42**
SKU 688017 | Part# THE1444-0870 or
SKU 688020 | Part# THE1444-0871 or
SKU 301766 | Part# THE1-4200



TIG® Torch and Accessories

SKU 295859
THEW4013802 **189⁹⁹**
(Required for TIG Welding)

- TIG Torch, 17V, 13", 8 Pin and Accessory Kit with 1/16", 3/32", 1/8" Thoriated
- Tungstens; 1/16", 3/32", 1/8" Collets; 1/16", 3/32", 1/8" Collet Bodies
- No. 5, 6, 7 AluminaNozzle; Short Back Cap; Long Back Cap



*TIG welding requires purchase of THEW4013802 Accessory Kit

250 Series OxyFuel Medium Duty Acetylene Outfit

SKU 573205
THE0384-2571 **249⁹⁹**

- Cutting Torch and Handle are Ready for Multiple Gas Options: Oxy-Acetylene, Propane, Butane, Natural and LP Gases, & Propane
- Welds Up to 1/2" Steel
- High Capacity: Cut 1/8" (3.2 mm) to 5" (127 mm)
- Simple to Use High Contrast Gauges
- Ergonomic Color Coded Knobs (Acetylene and Oxygen)
- Includes Handle, Cutting Attachment, Gauges, Welding Nozzle, Cutting Tip, Eye Protection and Striker



FP-95 Flux Cored Welding System

SKU 237664
THE1444-0322 **499⁹⁹**

- Portable FP-95 MIG/Flux-Cored Wire Welder
- Operates from Standard Household Outlet and Delivers 90 Amps
- Includes Tweco® Gun, Return Cable and Clamp, and .035" Spool of Flux-Cored Wire
- Easy to Use Key Setup Chart
- Gas Solenoid Not Included



MST 220i Welder

SKU 687990
THE1444-0872 **1,399⁹⁹**

- Includes: Firepower MST 200i Power Supply, Firepower 220 Amp MIG Gun, Firepower Argon/CO² Pressure Regulator/Gauge and Hose, Electrode Holder and Ground Clamp, 230V-115V Adapter Plug and Cable, Drive Roll and Contact Tips and CD with Multi-Language Operating Instructions
- Up to \$500 in Free Goods Available Visit www.firepoweronline.com/promotions for Details



OEM TOOLS

Auto Darkening Welding Helmet

SKU 362974
24357 **49⁹⁹**

- TIG Rated Variable Shade 9-13
- Viewing Area: 3.54" x 1.37"
- Battery Powered with Solar Assist
- Includes Replacement Cover Lenses



OEM TOOLS

Auto Darkening Welding Helmet with Grinding Function

SKU 347233
24358 **59⁹⁹** REG. \$79.99

- Variable Shade 9-13, Variable Sensitivity and Delay Controls
- Viewing Area: 3.62" x 1.65"
- Battery Powered with Solar Assist
- Includes Replacement Cover Lenses CE, ANSI Z87.1, CSA
- Z94.3, AS/NZS Approved



Offer Good Through June 30, 2017
While Supplies Last

SAVE \$20

Firepower

Stars and Stripes Darkening Welding Helmet

SKU 850068
THE1441-0087 **109⁹⁹**

- Variable Shade - Adjustable Welding Shade Levels from 9 to 13
- "Welding" or "Grinding" Selection for Process Mode
- Solar-Powered - So You Don't Have to Worry About Changing Batteries - Ever



Firepower

160 Amp MIG Spool Gun

SKU 434724
THE1444-0894 **329⁹⁹**

- Interfaces with Firepower MST 180i and 220i 3-in-1 Welders
- Rated 20% Duty Cycle and 160 Amps
- Includes Carrying Case



SHARK USA Pro-Tack Plastic Welder

SKU 255799
SHA17030 **329⁹⁹**

- Eco-Friendly Plastic Welder That is Great for Repairing Virtually Anything Made of Plastic
- Capable of Ironing Plastic to a Smooth Finish
- LED Read Out
- Rated to a Maximum of 65 Amps and Has 4 Power Settings
- Kit Includes: (4) Staple Styles, (2) Ironing Blades, Plastic Box for Staples and Plastic Storage Case



SHARK USA Core-Cut Staples (100 Pack)

49⁹⁹ ea.

- Flat Square SKU 255808 SHA17031
- Outside Corner/Sm. Wave SKU 255809 SHA17032
- Outside Corner/No Wave SKU 255820 SHA17033
- Inside Corner/Sm. Wave SKU 255839 SHA17034
- Inside Corner/No Wave SKU 255843 SHA17035
- Flat Small Wave SKU 255845 SHA17036
- Flat "S" Type SKU 255851 SHA17037

Heat-Shrink Tube Sets

REPAIR IT RIGHT

171 Piece Heat-Shrink Tube Set

SKU 420335
68165 **19⁹⁹**

- Protection and Insulation of Components and Wires
- Protection Against Water and Moisture Ingress Preventing Corrosion
- Color Coordinated Sizes
- Quick and Simple to Shrink By Heat Gun



106 Piece Waterproof Heat Shrink Tube Set

SKU 420334
68164 **29⁹⁹**

- Tubes Shrink to Fit Over Cable Splices and Can Be Used for Wire Harnessing, Covering, Marking and Bundling of Wires
- Adhesive Lined Inner Wall to Seal Out Moisture
- 3:1 Shrink Ratio
- Waterproof



90 Piece Waterproof Heat Shrink Terminal Set

SKU 462482
68166 **79⁹⁹**

- (30) Ring Connectors
- (15) Butt Connectors
- (15) Tin Butt Connectors
- (15) Female Disconnects
- (15) Male Disconnects
- Re-Sealable Plastic Case



Welding Accessories

WIRE

MIG Solid Wire E70S6 - .023 - 2 Lbs.	SKU 459160	SHA12000	16⁹⁹
MIG Solid Wire E70S6 - .023 - 11 Lbs.	SKU 459162	SHA12001	34⁹⁹
MIG Solid Wire E70S6 - .030 - 11 Lbs.	SKU 459164	SHA12003	29⁹⁹
MIG Solid Wire E70S6 - .035 - 33 Lbs.	SKU 459173	SHA12007	64⁹⁹
Flux Core Welding Wire - .030 - 2 Lbs.	SKU 459175	SHA12008	29⁹⁹
Flux Core Welding Wire - .035 - 2 Lbs.	SKU 459180	SHA12009	24⁹⁹

TIPS (25 PACK)

Lincoln MIG Contact .030 Tips	SKU 343402	SHA12874	24⁹⁹
Lincoln MIG Contact .035 Tips	SKU 343403	SHA12875	24⁹⁹
Miller MIG Contact .030 Tips	SKU 343404	SHA12877	24⁹⁹
Benzel and Tweco MIG Contact .023 Tips	SKU 343399	SHA12937	19⁹⁹
Benzel and Tweco MIG Contact .030 Tips	SKU 343401	SHA12938	24⁹⁹

ELECTRODES

E6011 1/8" Electrode 5 Lbs.	SKU 988902	THE14400106	19⁹⁹
E7018 1/8" Electrode 5 Lbs.	SKU 988904	THE14400186	19⁹⁹

SHARK USA



250 Piece Welding Stud Assortment

SKU 271198
68130 **18⁹⁹**

- 250 Piece, 2" x 3/40" Size
- Use with Stud Welder or Stud Gun
- Copper Coated Steel Construction



Leather Welder's Gloves

SKU 972316
THE14230051 **24⁹⁹**



Tubing Benders

Blue Bullet Tubing Bender

SKU 015350
BENBB1 **6,799⁹⁹**

- Leg Operated Control Lever at Front Keeps Hands Free
- Two Separate End Finishing Units at Rear for All Necessary Flaring and Expanding
- Degree Plate Located Up Front for Easy Viewing
- Comes Complete with Quick Release Bending and End Finishing Dies
- Includes High-Speed Clampless Swager and Internal Expander
- 3" Bending Capacity (Dies Optional)



Lift Gate Service

SKU 262533
RANLIFTGATE **135⁰⁰**

Leasing Terms Available.†

Ask Your AutoZone® Commercial Sales Manager.

Free Delivery!

in 48 Continental United States

Card System Complete with Rotation Dial / Computer CD

SKU 298074
BENCS-1 **679⁹⁹**

- Over 3,500 Cards on One CD
- 10,000 Bending Applications
- Includes: Rotation Dial for Standard and "Mirror Image" Bending



3" Die Kit (Optional)

SKU 095070
BEN300-1 **999⁹⁹**



Please note that the CS-1 Card System does not ship with the Benders and must be purchased separately.

DID YOU KNOW?

AutoZone® can cut most keys.

Contact Your AutoZone Commercial Sales Manager for Details



Contact Us:
1-877-AZTool1 Phone
 (1-877-298-6651) *Hablamos Español*

INVERTER TECHNOLOGY
DUAL VOLTAGE 115V / 230V

SHOP IRON



180 AMP DUAL PROCESS MIG/FLUX/ARC WELDER

SKU 554014 41198 **899⁹⁹**

- Welds 24 Gauge Up to 5/16" Mild Steel in a Single Pass
- Flux-Cored (No Gas): Tackles the Biggest Jobs
- MIG (Requires Shielding Gas): Weld Up to 5/16" Mild or Stainless Steel
- DC Stick: Handles Up to 5/32" Stick Electrodes
- Includes: 10 Ft. MIG Torch with .030 Tip, 10 Ft. ARC Lead, 10 Ft. Work Cable with Clamp, 115 /230 V Power Adapter and Argon Flow Meter/Regulator

30 AMP PLASMA CUTTER

SKU 554022 41199 **599⁹⁹**

- Rated 1/4" Clean Cut on Mild Steel with 1/2" Rough Sever
- Cuts Mild Steel, Stainless, Brass, Aluminum and Other Conductive Materials
- Includes: 10 Ft. Work Cable with Clamp and 115 /230v Power Adapter



SOLAR POWERED AUTO DARKENING WELDING HELMETS



SKU 102313 41288 **99⁹⁹**



SKU 102314 41290 **99⁹⁹**

- Extra Large Viewing Area: 3.86" X 2.17"
- Automatically Darkens in 1/30,000 of a Second
- Ultra High Performance Filters Protects Against UV and IR
- Variable Shades from DIN 9 to DIN 13
- Outside Sensitivity Adjustments Provide Clear Vision Both Prior and During Welding
- Durable, Light Weight Material is Corrosion Resistant and Flame Retardant
- Special Turnover Headband Mechanism Allows for Greater Comfort and Reduces Fatigue
- Utilizes High Performance Solar Cells W/2 Built-In 3V Lithium Batteries as Power Back-Up
- Complies with DIN, ISO, EN Safety Standards and ANSI Z87.1-2003 Standards

Soldering

Electrical Mini Torch - Butane Powered

SKU 238730 86278 **16⁹⁹**

- Pinpoint, Windproof Flame of 2,400 Degrees F for Precise, Effective Usage
- Contains Durable, Weather-Resistant Ignition System
- Includes Safety Lock
- Lightweight and Easy to Use
- Includes 1 Butane Cartridge



Mechanic's Mini Torch

SKU 804655 24353 **19⁹⁹**

- Designed for Light Welding, Auto Repair and Heating Material in Confined Spaces
- Adjustable Flame Lights Upside Down
- Auto Ignition, Refillable
- Safety Lock When Not in Use
- Butane Not Included



Professional 3-in-1 Butane Micro Torch Kit

SKU 420339 24356 **34⁹⁹** REG. \$39.99

- 3-in-1 Design Can Be Used as a Soldering Iron, Torch or Hot Air Blower without Iron Tip
- Easy to Set on Table Top with the Base After Operation
- Micro Torch Kit Includes: Torch, Metal Tip Wicking Cup with Sponge, Heat-Shrink Deflector, Chisel Point Tip, Anvil Solder Tip, Needle Tip and Hot Air/Soldering Tip and Base
- Ideal for Use with Electrical Repair, Tin and Plastic Melting, Heat-Shrinkable Tubing, Auto Repair, Hobby Repair and Jewelry Repair
- Power Range: 30w - 125w

SAVE \$5



Offer Good Through June 30, 2017 - While Supplies Last

Professional 3-in-1 Soldering Iron Kit

SKU 420338 24355 **34⁹⁹** REG. \$39.99

- 3-in-1 Design Can Be Used as a Soldering Iron, Torch or Hot Air Blower
- Soldering Iron Kit Includes: Soldering Iron, Metal Tip Wicking Cup with Sponge, Solder Wire, Protective Tip Cap, Heat-Shrink Deflector, Chisel Point Tip, Anvil Solder Tip, Needle Tip and Hot Air/Soldering Tip

SAVE \$5



Offer Good Through June 30, 2017 - While Supplies Last

RV Ready

RV READY



CHAMPION
POWER EQUIPMENT

3500 Watt Portable Generator

SKU 020730 379⁹⁹
CHM46596

- 196cc Champion OHV Engine
- Fuel Tank - 3.8 Gallon
- RV Ready - Equipped with a Standard 30A RV Outlet
- Volt Guard™ Protects Your Appliances from Power Surges
- Runs Up to 12 Hours on a Full Tank of Gas
- Durable Steel Frame
- Voltmeter - Displays Power Output
- 49 State EPA Compliant



Dependable Power for Home, Recreation, or Emergencies



12 HRS. RUNTIME

68 DBA

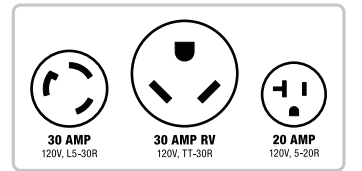

Dual Fuel

DUAL FUEL
Run this generator on **GASOLINE** or **PROPANE**

CHAMPION
POWER EQUIPMENT

7500 Watt Dual Fuel Generator with Electric Start

SKU 020752 1,049⁹⁹
CHM100165

- Run/Start Watts 7500/9375 (Gasoline*)
- 439cc Champion OHV Engine
- Runs on GASOLINE or PROPANE Straight Out of the Box
- Gasoline Fuel Tank - 6.1 Gallon
- Touch Start - Battery Included for Push-Button Electric Start
- Volt Guard Protects Your Appliances from Power Surges
- Runs Up to 8 Hours on a Full Tank of Gasoline or 5.5 Hours on a 20 Lb. Propane Tank
- Intelligauge to Monitor Power Output and Maintenance Intervals
- 50 State CARB Compliant

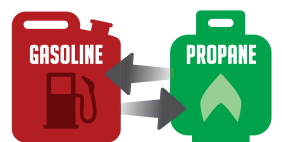

9 HRS. RUNTIME

68 DBA

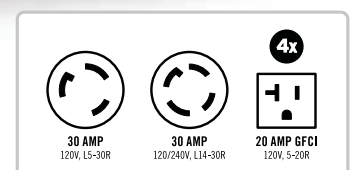

AIR CONDITIONING

It's about time somebody introduced R/R/R machines for the 21st century!

ARCTIC COMMANDER

RECOVERY / RECYCLE / RECHARGE MACHINES



COMMANDER4000
R1234YF & HYBRID

COMMANDER3000
R134a & HYBRID

COMMANDER2000
R134a FULLY AUTOMATIC

COMMANDER1000
R134a SEMI-AUTOMATIC



Mastercool introduces its new ARCTIC COMMANDER line of RRR machines. Equipped with the latest technology, all models come standard with an 8" GUI Command Center. Navigate through all functions, features and instructions with ease. Wi-Fi capabilities allow for real time, interactive communication and troubleshooting.

COMMANDER1000 Semi-Automatic R134a R/R/R Machine

SKU 471051 MSC1000 **2,999⁹⁹**

- R134a
- Wi-Fi Capable
- Vacuum Leak Test
- Cylinder Heater
- 3 CFM Vacuum Pump
- Dust Cover

COMMANDER2000 Fully Automatic R134a R/R/R Machine

SKU 471040 MSC2000 **3,899⁹⁹**

- R134a
- Wi-Fi Capable
- Vacuum Leak Test
- Refrigerant Database
- Cylinder Heater
- 6 CFM Vacuum Pump
- Dust Cover
- Automatic Oil Injection

COMMANDER3000 R134a and Hybrid R/R/R Machine

SKU 471054 MSC3000 **4,099⁹⁹**

- R134a and Hybrid
- Wi-Fi Capable
- Vacuum Leak Test
- Refrigerant Database
- Cylinder Heater
- 6 CFM Vacuum Pump
- Dust Cover
- Automatic Oil Injection (Standard R134a Vehicle)
- Hose Flushing

COMMANDER4000 R1234yf and Hybrid R/R/R Machine

SKU 471061 MSC4000 **5,999⁹⁹**

- R1234yf and Hybrid
- Wi-Fi Capable
- Vacuum Leak Test
- Refrigerant Database
- Cylinder Heater
- 6 CFM Vacuum Pump
- Dust Cover
- Hose Flushing
- Built-In Identifier

Also Available
SKU 471058 MSC4000X **4,924⁹⁹**

- Same as MSC4000 but without Identifier



Reduce Down Time...
Keep an Extra Filter Set On Hand!

Replacement High/Low Filter Set

SKU 389222 MSC69788FLTPK **139⁹⁹**

- Replacement Filter Pack Kit for Mastercool's MSC69788-A, MSC69789 and MSC69789-H Recovery, Recycle, and Recharge All-in-One Units



Recovery Machines

CONTACT US FOR FACTORY SETUP AND TRAINING
1-877-AZTool1 (1-877-298-6651)

All MAHLE Recovery Machines are Fully Automatic and Include a 2-Year Warranty

R134a A/C Refrigerant Handling System

SKU 850570 MSSACX1120H **2,799⁹⁹**

- ECO LOCK® Quick Couplers
- Designed for Servicing All Passenger Cars, Trucks and Hybrid Vehicles
- High Performance Vacuum Pump to Ensure Faster Service Times

Hybrid Ready



R134a A/C Refrigerant Handling System

SKU 850573 MSSACX1150 **3,399⁹⁹**

- 4.3" Color TFT Touchscreen
- ECO LOCK® Quick Couplers
- High Performance Vacuum Pump to Ensure Faster Service Times
- Automatic Oil Injection and Measurement



R134a A/C Refrigerant Handling System

SKU 850571 MSSACX1150H **3,399⁹⁹**

- Hybrid Function, Designed for Servicing All Passenger Cars, Trucks and Hybrid Vehicles
- 4.3" Color TFT Touchscreen
- ECO LOCK® Quick Couplers
- High Performance Vacuum Pump to Ensure Faster Service Times

Hybrid Ready



R134a ArticPro Refrigerant Handling System

SKU 850566 MSSACX1180 **3,849⁹⁹**

- Completely Recover, Recycle Or Recharge R134a Air Conditioning Systems
- Quicker Service Times
- Automatic Air Purge
- Fully Automatic



R134a ArticPro Refrigerant Handling System

SKU 850567 MSSACX1180H **3,899⁹⁹**

- Completely Recover, Recycle Or Recharge R134a Air Conditioning Systems
- Hybrid Ready



R1234YF ArticPro Refrigerant Handling System Hybrid with Printer and Identifier

SKU 850569 MSSACX1280 **5,699⁹⁹**

- Completely Recover, Recycle Or Recharge R1234YF Air Conditioning Systems In Conventional and Hybrid Vehicles
- Fully Automatic
- Quicker Service Times
- Automatic Air Purge

Hybrid Ready



MAHLE

A/C Recovery Filter Dryer

SKU 470141 MSS268069600 **149⁹⁹**



- Fits ACX1120H, 1150, 1150H
- Removes Moisture and Contaminants from Refrigerant
- Easy Installation
- Protects Your Investment

A/C Recovery Machine Filter Kit for RTI and Mahle

SKU 818739 RTI3608213300 **119⁹⁹**



- Includes All Components Necessary for Basic Maintenance on RHS980 and ACX1180 Series Units
- Removes Acids and Moisture that can Damage Compressors and Contaminate Oil

HF01234YF Recovery, Recycle and Recharge with 8 Ft. Hoses and 50 Lb. Tank

SKU 452639 CPSFA1234 **3,724⁹⁹**

- Fully Automatic Operation of Recovery, Recycle, Evacuate, air Purge and Recharge
- Easy To Program Command-Based LCD Display Supports Five Languages
- 2/3HP Oil-less Compressor
- All Steel Construction With Heavy Duty Casters
- Includes 8' Hoses and 50 Lb. Storage Tank
- Compliant with SAE Standards



R134a Refrigerant/Recover/Recharge Machine with Printer

SKU 695135 CPSFX134A **3,999⁹⁹**

- On-Board Vehicle A/C Data: 1994-2015
- 10 Ft. Charging Hoses
- 6 CFM Vacuum Pump
- Heater Blanket Included
- 1-2-5 Warranty



Hybrid Ready

1234YF Recovery/Recycle/Recharge with Printer

SKU 850568 CPSFX1234 **6,699⁹⁹**

- Patented Oil-less Compressor
- 6 CFM Vacuum Pump/50 Micron Rated
- Patented Motor-Controlled Ball Valves
- AC Systems Capacity Database Included
- 1-2-5 Warranty



Hybrid Ready

Dual Gas Recovery/Recycle/Recharge Machine with Printer

SKU 850572 CPSFX3030 **7,119⁹⁹**

- Convertible Between R134a and R1234yf
- Built-In Refrigerant Identifier
- Vehicle Refrigerant Capacity Database Included
- Includes 2 Tanks and 2 Sets of Hoses
- 1-2-5 Warranty



Hybrid Ready

cps

AR2788/2788S Recovery Machine Filter

SKU 186483 CPSARXF5 **94⁹⁹**



- Filter Removes Moisture and Contaminants Before the Refrigerant is Returned to the System
- Designed for Use on the AR2788S

Leasing Terms Available!†

Ask Your AutoZone®
Commercial Sales Manager

AutoZone®
Tool & Equipment QUARTERLY

Portable Recovery Systems



Portable R134a Recovery System

SKU 290024 **1,369⁹⁹**
MSC69100

- High Performance Oil-Less Compressor
- Includes an Oil Separator and Filter Dryer to Clean Refrigerant During Recovery
- Recovers All Refrigerants, 30 Lbs. DOT Recovery Tank Included



Portable A/C Recovery Machine

SKU 504026 **1,499⁹⁹**
CPSTRA21

- SAEJ2810 Approved, Fastest Recovery Recycle Machine in the Industry
- Oil Separator and Filter Includes 30 Lbs.
- Tank and Manifold Set with 60" Hoses and Manual Couplers



Vacuum Pump Kits



A/C Service Set with Air Vacuum Pump - R134a

SKU 850564 **99⁹⁹**
68991

- Complete Kit for Diagnosing and Charging R134a A/C Systems
- Includes: Air Vacuum Pump with 1/2" ACME R134a and R12 Connectors, Brass Manifold Gauge Set with 60" Hoses and Snap Style Couplers, Brass Can Tap Valve and Large Diameter Dual Scale Thermometer



A/C Starter Kit - R134a

SKU 695127 **179⁹⁹**
68987

- OEMTOOLS® 1.8 CFM, 100 Micron Single Stage Vacuum Provides Fast, Thorough Evacuation and Provides Powerful, Quiet, High Vacuum Capability.
- Ensures Moisture Removal
- Kit Includes: OEMTOOLS® Professional Quality Extruded Aluminum Manifold with Sight Glass, 72" Hoses, High Quality Manual Couplers and Easy-to-Read Spring Dampened Gauges to Reduce Flutter
- OEMTOOLS® R134a Can Tap Connects to Any ACME Threaded R134a Can



3 Piece High Performance A/C Kit

SKU 626121 **249⁹⁹**
68989

- OEMTOOLS® 6 CFM, 75 Micron Single Stage Vacuum Provides Fast, Thorough Evacuation and Provides Powerful, Quiet, High Vacuum Capability, Ensuring Moisture Removal and Reduces Evacuation Time.
- Kit Includes: OEMTOOLS® Professional Quality Extruded Aluminum Manifold with Sight Glass, 72" Hoses, High Quality Manual Couplers and Easy-to-Read Spring Dampened Gauges to Reduce Flutter
- OEMTOOLS® 3-in-1 Can Tap Fits 1 Lb. Cans of R134a, R12 and 2" Oil Charge Cans and Includes 1/2" ACME Male and 1/4" FL - Male Ports

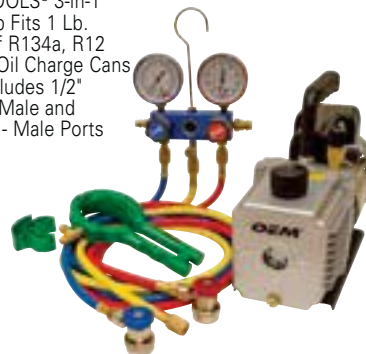

A/C Professional Set - R134a

SKU 695129 **299⁹⁹**
68988

- OEMTOOLS® 4 CFM, 75 Micron Single Stage Vacuum Provides Fast, Thorough Evacuation and Provides Powerful, Quiet, High Vacuum Capability, Ensures Moisture Removal and Reduces Evacuation Time
- Kit Includes: OEM Professional Quality Extruded Aluminum Manifold with Sight Glass, 72" Hoses, High Quality Manual Couplers and Easy-to-Read Spring Dampened Gauges to Reduce Flutter
- OEMTOOLS® 3-in-1 Can Tap Fits 1 Lb. Cans of R134a, R12 and 2" Oil Charge Cans and Includes 1/2" ACME Male and 1/4" FL - Male Ports
- OEMTOOLS® AC Refrigerant Leak Detector is Sensitive to 0.1 Oz./Year and Responds to All Halogenated Refrigerants



A/C Recycle Guard Accessories



Recycle Guard™ R12 Adapter Kit, 1/4" Flare

SKU 504086 **39⁹⁹**
AIR72138



Recycle Guard™ for R134a - 1/2" ACME Fittings with 36" Service Hose

SKU 504082 **289⁹⁹**
AIR72101

- Protect Your Recovery Equipment from Debris, Sealant, Dye, Excess Lubricant and Other Contaminants
- Works with All A/C Service Equipment



Recycle Guard™ for 1/4" SAE Flare with 36" Service Hose

SKU 504083 **289⁹⁹**
AIR72102

- Protect Your Recovery Equipment from Debris, Sealant, Dye, Excess Lubricant and Other Contaminants
- Works with All A/C Service Equipment



Dual Automatic Recycle Guard™ for R134a with (2) 36" Service Hoses

SKU 504091 **439⁹⁹**
AIR75000

- High- and Low-Side Protection from Debris, Sealant, Dye, Excess Lubricant and Other Contaminants
- No Technician Input Required - Switches Automatically from Recover to Recharge
- Traps Metal Shavings, Desiccant Particles and Other Harmful Debris
- Maintains Refrigerant Flow



A/C Recovery Machine Accessories



A/C Recovery Machine Vinyl Dust Cover

SKU 291481 **99⁹⁹**
ROB17492

- Medium Gray Color with Cool-Tech Logo
- Fits All 342000, 17700-2K, 34700-2K, 34134Z, 34700Z, 34711-2K, AC375, AC375A, 17700Z, 34702Z



Refrigerant Canister Filter™ 1/2" Acme

SKU 544562 **54⁹⁹**
AIR72900

- Use Inline Between the Virgin Refrigerant Tank and the Tank Fill Hose
- Helps Stop Debris from Entering Your Refrigerant Supply
- Protects Your Recovery Machine from Tank Debris



Spin-On Filter-Drier

SKU 414883 **69⁹⁹**
ROB34724

- Fits Current Models: ROB34288, ROB34788, ROB34988, ROB34700Z
- Genuine Robinair Spin-On Filter with the Proper Serial Number to Input for Easy Installation
- High Quality Filter Protects Your Investment
- Easy to Install



Recycling Filter-Drier

SKU 522875 **74⁹⁹**
ROB34430

- For Older 17700A, 34450, 34700 (1997), AC375, AC375A, AC375C, and 34134Z Robinair Recovery Machines



A/C Recovery Machine Vinyl Dust Cover

SKU 752708 **129⁹⁹**
ROB17490

- Medium Gray Color with Cool-Tech Logo
- Fits 34900, 34800-2k, and 17800b Series



A/C Recovery Machine Maintenance Kit

SKU 752703 **79⁹⁹**
ROB13172

- Contains: (1) Quick Change Filter-Drier to Be Used on Both R-12 and R-134a Stations and (1) 16 Ounce Bottle of Our Premium High Vacuum Pump Oil
- For Models Using 34724 Filter/Drier - 17700A, 17700-2K, 34700, 34700-2K, 34800, 34800-2K, 34900 Series



AR2788/2788S Recovery Machine Filter

SKU 186483 **94⁹⁹**
CPSARXF5

- Filter Removes Moisture and Contaminants Before the Refrigerant is Returned to the System
- Designed for Use on the AR2788S



A/C Capacities Database - 2016

SKU 597992 **279⁹⁹**
ROB34412-A

- For Use with Robinair 34788NI and 34788NI-H A/C RRR Machines
- Displays Charge Amount and Oil Capacities for Vehicle Model Years 1997-2016



A/C Capacities Database - 2016

SKU 331126 **279⁹⁹**
ROB34411-F

- Works with Robinair 34788, 34788-H, and 34988 A/C RRR Machines
- Includes Charge Amounts and Component Oil Capacities for Vehicle Model Years 1997-2016



Vinyl Dust Cover for A/C Recovery Machine

SKU 751574 **129⁹⁹**
ROB17499

- Protect Your Investment with a Heavy-Duty Vinyl Dust Cover
- Fits AC1234-6, 34788NI, 34788NI-H Models



A/C Recovery Filter Dryer

SKU 470141 **149⁹⁹**
MSS268069600

- Fits ACX1120H, 1150, 1150H
- Removes Moisture and Contaminants from Refrigerant
- Easy Installation
- Protects Your Investment



Replacement High/Low Filter Set

SKU 389222 **139⁹⁹**
MSC69788FLTPK

- Replacement Filter Pack Kit for Mastercool's MSC69788-A, MSC69789 and MSC69789-H Recharge-Recover-Recycle All-in-One Units



AIR CONDITIONING

Vacuum Pumps

Air-Operated Vacuum Pump

- SKU 544730 **29⁹⁹**
24533
- Includes 1/2" ACME (R134a) and R12 Connectors
 - Air Pressure Range: 75 - 180 PSI
 - Air Consumption: 4.2 CFM @ 90 PSI
 - Vacuum Capacity: 28.3" of Mercury @ 90 PSI



1.8 CFM Single Stage Vacuum Pump

- SKU 466312 **99⁹⁹**
24500
- 1/4 HP, 110V Motor
 - 100 Microns
 - Internal High Volume Cooling Fan for Extended Use
 - Inlet Ports: 1/2" ACME - 1/4" Flare
 - Oil Capacity: 200 mL, Included



4 CFM Single Stage Vacuum Pump

- SKU 466305 **149⁹⁹**
24501
- 1/3 HP, 110V Motor
 - 75 Microns
 - Internal High Volume Cooling Fan for Extended Use
 - Inlet Ports: 1/2" ACME - 1/4" Flare
 - Oil Capacity: 330 mL, Included



6 CFM Single Stage Vacuum Pump

- SKU 466306 **199⁹⁹**
24502
- 1/3 HP, 110V Motor
 - 75 Microns
 - Internal High Volume Cooling Fan for Extended Use
 - Inlet Ports: 1/2" ACME - 1/4" Flare
 - Oil Capacity: 330 mL, Included



Vacuum Pump Oil (8 Oz.)

- SKU 363429 **9⁹⁹** **STORE STOCK**
24399
- Increases Life Span of the Pump
 - Performance of Your Pump Depends on Regular Service and the Quality and Purity of the Vacuum Pump Oil That You Use
 - Compatible for Use in Pumps Made by Most Manufacturers



Premium Vacuum Pump Oil 1 Quart Bottle

- SKU 517580 **19⁹⁹**
CPSVPOQ12
- Compatible with Most Pumps
 - Increases Life Span of the Pump
 - Performance of Your Pump Depends on Regular Service and the Quality and Purity of the Vacuum Pump Oil That You Use



1.5 CFM Single Stage Vacuum Pump

- SKU 573206 **139⁹⁹**
MSC90059-R
- 1/6 HP
 - 75 Microns



6 CFM 2 Stage Vacuum Pump

- SKU 301619 **349⁹⁹**
MSC900662V110
- 1/3 HP
 - 15 Microns



Tube Assortment

Master Orifice Tube Assortment

- SKU 851868 **24⁹⁹**
24564
- Covers Most Vehicles That Require Air Conditioning Orifice Tubes
 - Includes: Chrysler Purple T-Top, Ford Black, Ford and Mazda Black, Ford Blue, Ford Brown, Ford Green and Chrysler Orange, Ford Red, GM Black T-Top, GM White, GM Yellow, Jeep Green-White, Volvo Yellow



Valve Tools

No Gas Loss A/C Valve Core Remover/Installer

- SKU 466321 **44⁹⁹** REG. \$49.99
24529
- Remove and Install Standard R134a Valve Cores without the Loss of Refrigerant
 - Built-In Ball Valve Retains Charge and Allows Access to A/C System
 - For 13 mm and 16 mm High and Low Service Ports



SAVE \$5

Offer Good Through June 30, 2017 - While Supplies Last

Thermometers

-58 to 300° F Digital Pocket Thermometer

- SKU 447147 **25⁹⁹**
24351
- Accurate Readings from -58 to 300° F (±2°) and from -50 to 150° C (±1°)
 - Digital Display Will Rotate 180° and Move Up and Down for Easy Viewing
 - Comes with 1.5V Battery



Non-Contact Infrared Thermometer

- SKU 951642 **31⁹⁹**
25245
- Temp Range: 35° to +365°C, -31° to +689°F
 - Distance to Spot Ratio of 8:1
 - Laser Pointer



A/C Flush

A/C System Flush Kit

- SKU 466308 **49⁹⁹**
24515
- Use with MSC91049 A/C Flush Solvents
 - Includes: Canister, Hose, Blow Gun, Rubber Tip and Cylinder Cap



A/C Quick Flush 17 Oz. Replacement

- SKU 695647 **24⁹⁹**
MSC91050



A/C Flush 32 Oz. Bottle

- SKU 695650 **24⁹⁹**
MSC91049-32



A/C Flush Solvent (1 Gallon)

- SKU 695653 **49⁹⁹**
MSC91049-128
- Non-Toxic, Quick Evaporating A/C Flush
 - Effectively Removes Debris and Sludge from A/C Components
 - Solvent-Based, Leaves No Residue
 - Professional Use Only
 - Flush Any A/C System



A/C Flush 6 Pack 32 Oz. Bottles

- SKU 695652 **99⁹⁹**
MSC91049-32-6



A/C Quick Flush 17 Oz. Replacement 6 Pack

- SKU 695649 **139⁹⁹**
MSC91050-6



A/C Flush 1 Gallon Case of 4

- SKU 695654 **198⁹⁹**
MSC910491284



Can Taps

Refrigerant and Oil Charge Can Tap

- SKU 466313 **19⁹⁹**
24523
- Fits 1 Lb. Cans of R134a, R12 and 2" Oil Charge Cans
 - Plier Type Grip with Positive Lock
 - Includes: 1/2" ACME Male and 1/4" FL Male Ports with Safety Valve



R134a DIY Refrigerant Recharge Kit

- SKU 466316 **19⁹⁹**
24525
- Will Service Most R134a Systems
 - Includes High Pressure Hose and Quick Disconnect Coupler



Digital Scales

Digital Refrigerant Scale (240 Lbs. Capacity)

- SKU 752521 **149⁹⁹**
24560
- High-Visibility .75" x 2.5" LCD Backlit Display
 - (3) Units of Measure: kg/Oz./Lbs.
 - Automatic Shut-Off After 10 Minutes, Backlight Will Shut-off After 3 Minutes
 - Fully Enclosed and Removable Metal Scale Platform Enables Use of Product In or Out of the Protective Case



Electronic Charging Scale (220 Lbs. Capacity)

- SKU 481699 **199⁹⁹**
24512
- Heavy Duty Load Cell for Years of Reliable Service
 - Large LCD Control Box



Accu-Charge II™ / Electronic Charging Scale 240 Lbs. Capacity

- SKU 290029 **229⁹⁹**
MSC98210A
- Programmable with Alarm



Leasing Terms Available!†

Ask Your AutoZone®
Commercial Sales Manager

AutoZone®
Tool & Equipment QUARTERLY

Manifold Gauges



R134a Brass Manifold Gauges Set

SKU 752520 24563 **64⁹⁹**

- High Quality Brass Body with Sight Glass
- Large 2-1/2" Gauges are Easy to Calibrate and Have a High Impact Lexan Lens
- 60" 3,000 PSI Burst, 600 PSI Working Pressure Hoses
- Snap Style Quick Couplers



R134a Manifold Gauge Set with Sight Glass

SKU 466319 24527 **99⁹⁹**

- Easy-to-Read Spring Dampened Gauges to Reduce Flutter
- 72" Hoses with Manual Couplers



R134a/R12/R22 Dual Manifold Gauge Set

SKU 512961 27229 **149⁹⁹**

- For Use with R134a, R12 and R22
- 3,000 PSI Burst and 600 PSI Max
- SAE J2196/ R134a
- Extra Long High and Low Hoses: 72"; Freon Hose: 96"
- Manual Couplers Included



R1234YF Manifold Gauge Set

SKU 752518 24559 **149⁹⁹**

- 3" Easy-to-Read Gauges with Temperature Chart
- 72" Hoses
- High Quality 6-Ball Manual Couplers



R134a Aluminum Manifold Kit with Dye Injector

SKU 290023 MSC89660UV **149⁹⁹**

- Includes: R134a Aluminum Manifold, 60" Hoses, Standard Couplers and 10 Application Mini Dye Injector

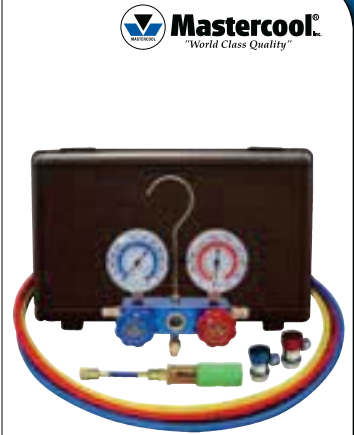

R134a Aluminum Manifold Kit with Dye Injector

SKU 290022 MSC89661UV **169⁹⁹**

- Includes: R134a Aluminum Manifold, 60" Hoses, Manual Couplers and 10 Application Mini Dye Injector

Manifold Gauge Repair

1/4" Hose Set 72"

SKU 752515 24557 **39⁹⁹**

- 72" 1/4" SAE 3 Hose Set Color Coded: Red, Yellow and Blue



R134a Hose Set 72"

SKU 752516 24558 **39⁹⁹**

- 72" R134a 3 Hose Set Color Coded: Red, Yellow and Blue



1/4" Hose Set SAE 60"

SKU 347260 24390 **59⁹⁹**

- Maximum Working/Burst Pressure 300PSI / 3000PS
- Solid Brass Fittings
- 60" Long



Replacement Gauge Low Side for A/C Manifold

SKU 481709 24531 **14⁹⁹**

- This is a Low Compound Gauge for OEMTOOLS® and Other Brands of A/C Manifold Sets Used to Service A/C Systems on Cars
- Reads 0-120 PSI and 0-30" Hg
- 1/8" NPTF Male Threads



96" R134a Red Hose

SKU 489152 MSC84963 **39⁹⁹**

- 1/2" ACME-F and 14 mm-M Auto A/C fittings - 96"



96" R134a Blue Hose

SKU 489151 MSC84961 **39⁹⁹**

- 1/2" Acme-F and 14 mm-M Auto A/C Fittings - 96"



1/4" SAE Hose Set

SKU 512962 27230 **69⁹⁹**

- High Pressure Hose Length: 6 Feet.
- Low Pressure Hose Length: 6 Feet Freon
- Hose Length: 8 Feet.



Replacement Gauge High Side for A/C Manifold

SKU 481705 24530 **14⁹⁹**

- Replacement High Side Gauge Fits OEMTOOLS® and Other Brands of A/C Manifolds Used to Service A/C Systems on Cars
- 1/8" NPTF Male Threads
- Reads 0-500 PSI Hose



A/C Couplers

R134a Refrigerant Tank Adapter

SKU 850565 24554 **19⁹⁹**

- Male Low-Side R134a to Female 1/2" ACME
- Attaches to Virgin Tank and Low-Side Service Coupler



R134a High Side Manual Coupler

SKU 347267 24395 **29⁹⁹**

- All Metal Construction for Extra Durability
- 6 Ball Coupler for Secure Grip
- Includes an Adapter for Use with R12 Hoses



R134a Low Side Manual Coupler

SKU 347266 24394 **29⁹⁹**

- All Metal Construction for Extra Durability
- 6 Ball Coupler for Secure Grip
- Includes an Adapter for Use with R12 Hoses



R134a High and Low Side Coupler Set

SKU 362980 24396 **34⁹⁹** REG. \$39.99

- Change Your Old R12 Manifold Set to R134a with This Set of Manual Couplers
- All Metal Construction for Extra Durability
- Includes Adapter for Use with R12 Hoses
- 6 Ball Coupler for Secure Grip



Offer Good Through June 30, 2017 While Supplies Last

R134a Extra Long Coupler

SKU 752517 24556 **49⁹⁹**

- Used on BMW E60 (2003-2009 5 series) and Some Volvo Models
- Allows for A/C Service with No Radiator Removal



Conversion Coupler Set R134A to HFO-1234YF

SKU 752527 24561 **64⁹⁹** REG. \$69.99

- HFO-1234YF Manual Couplers with 14 mm Female Threads to Convert R134a Manifold and Hoses to HFO-1234YF
- Includes: Tank Adapter, 1/2" ACME Right Hand to 1/2" ACME Left Hand Adapter



Offer Good Through June 30, 2017 While Supplies Last

A/C Service Tools



A/C Condenser Fin Comb Straightener/Cleaner

SKU 466317 24526 **12⁹⁹**

- Clean and Straighten Condenser and Evaporator Coils
- Compact Design for Confined Spaces
- Includes (6) Clearly Marked Combs: 8, 9, 10, 12, 14 and 15 Fins per Inch



A/C Clutch Hub Installer

SKU 695625 33627007 **17⁹⁹**

- For Use in Conjunction with OEM 27006, A/C Clutch Hub Plate Remover to Install Chrysler C-171, A590, 6C17 and Tecumseh HR-980 Compressor Clutches



A/C Orifice Tube Tool

SKU 695629 33627004 **21⁹⁹**

- Fits Many GM and Ford Models



A/C Clutch Plate Remover Shoe Tool

SKU 695630 33627002 **21⁹⁹**

- Used for GM A6 and R4 Compressor Clutches
- Simply Screw Into Clutch and Turn Pressure Screw to Remove



A/C Clutch Puller Jaws

SKU 695624 33627008 **23⁹⁹**

- Additional Jaws for Use with the OEMTOOLS® 27001 AC Pulley Puller



A/C Clutch Hub Plate Remover

SKU 695626 33627006 **23⁹⁹**

- Removes Club Hub from the Compressor
- For Use with Chrysler C-171, A590, 6C17 and Tecumseh HR-980 Compressor Clutches



Compressor Turner Tool

SKU 504135 AIR67700 **24⁹⁹**

- OEM-Approved Compressor Start-up Assistance
- Prevent New Compressor Seizure at Startup
- Fits Most Hex-less Clutch Hubs



A/C Clutch Holding Tool

SKU 695102 33627000 **25⁹⁹**

- Holds Compressor Clutch in Place When Removing Holding Bolt
- Adjust Pins to Fit Holes in Clutch



A/C Clutch Hub Remover

SKU 695628 33627005 **30⁹⁹**

- Removes Club Hub from Ford ES-6 Compressors



Orifice Tube Remover Set

SKU 752530 24562 **39⁹⁹**

- To Use, Simply Turn Into Orifice Tube for Grip Then Turn Out
- Includes Auger for Removing Broken Orifice Tubes



A/C Compressor Pulley Removal Tool

SKU 695609 33627001 **45⁹⁹**

- Makes AC Compressor Pulley Removal Jobs Fast and Easy
- Can Be Used with OEMTOOLS® 27008 Clutch Puller Jaws

THEXTON



Radiator/Condenser Cleaning Wand

SKU 514015 THX467A **99⁹⁹**

- New, Improved High Pressure Air/Water Cleaning Wand Reaches 24-Inches Between Radiator and Condenser, Under Mowing Decks, Etc. to Clean Away Dirt and Debris
- Made of Zinc-Plated Steel with Adjustable Valve Assembly
- Special Tips Deliver Air or Water at a 90 Degree Angle

AIR CONDITIONING

Leak Detection Lights

UV Pen Light

SKU 695128
24610 **24⁹⁹**

- Pen Style Ultraviolet Light
- Lightweight, Aluminum Casing
- Convenient Pocket Clip
- Maximum Continuous Run Time is 4.5 Hours



Mini UV Flashlight - 12 LED

SKU 300782
MSC53512-UV **34⁹⁹**

- 25,000 Hour Bulb Life
- 3 AAA Batteries / Operates for 22 Hours Under Normal Work Conditions
- Comparable to 50 Watt Illumination
- UV Goggles Included



Compact UV Flashlight - 17 LED

SKU 300783
MSC53517-UV **54⁹⁹**

- 25,000 Hour Bulb Life
- 3 AAA Batteries / Operates for 22 Hours Under Normal Work Conditions
- Comparable to 75 Watt Illumination
- UV Goggles Included



USB Rechargeable UV Light with Glasses

SKU 626122
EXPE93-E02 **59⁹⁹**

- 1W Bulb That Casts a Beam Up to 5 Meters
- 0.8 Lumens
- 3 Light Modes: 25%, 50% and 100%
- Runtime: 12 Hours
- USB Cord



Mechanic's 500 Lumen Rechargeable Flashlight and 450 Lumen Ultra Slim Wand with UV Inspection

SKU 344835
24607 **89⁹⁹**

3 Lights in 1!

- 500 Lumen Flashlight Will Cast a 170 Meter Beam
- Ultra Slim 450 Lumen Inspection Light Casts a 30 Meter Beam
- 3 Powerful, UV LED Lights on Inspection Light Detect Leaks Quickly and Easily
- Detachable 180 Degree Swivel Hook with Magnets
- Battery Lasts 3.5 Hours at 100% and Fully Charges in 5 Hours
- 5 Light Modes
- Comes with (1) USB Charging Cord, AC Adapter, (1) 18650 Rechargeable Battery, and a 180 Degree Swivel Hook



3-in-1 Multi-Use Rechargeable Diagnostic Work Light

SKU 591153
24609 **109⁹⁹**

NEW

TOOL OF THE MONTH

JUNE

SEE INSERT FOR DETAILS

- 3 Different Light Modes - White, Yellow (Smoke Detection), UV/Black (Leak Die Detection)
- Holds Charge for a Longer Runtime with 4400 mAh Li-Ion Battery
- Built-in Power Bank/Source Charges Cell Phones, Tablets, and Hand Held Devices
- Includes Universal Micro USB Charger Lets You Charge Anywhere
- LCD Battery Indicator Screen Displays Charge Level
- Strong Magnets on Each End
- Runtime: White (5.5 Hrs.), Yellow (5.5 Hrs.), UV/Black (12.5 Hrs.)
- Accessory Kits Available

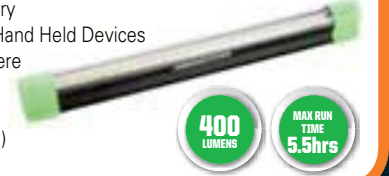

Complete A/C and Fluid Leak Detection Starter Kit

SKU 291378
TRATP8621 **79⁹⁹**

- 50 Watt 6 LED Lamp
- Pinpoints A/C, Oil Systems and Coolant Leaks
- EZ-Ject™ Dye Injector with (3) 1 Oz. Bottles of Dye



OPTI-PRO™/EZ-Shot™ A/C Dye Injection Kit

SKU 568718
TRATP8616 **154⁹⁹**

- Cordless, Economical, True UV Led Leak Detection Flashlight
- EZ-Shot A/C Dye Injection Gun
- 8 Oz (237 ml) BigEZ™ Universal/Ester A/C Dye Cartridge



EZ-Shot™ A/C and Fluid Leak Detection Kit with TP8620 OPTI-Lite™

SKU 291402
TRATP8626 **159⁹⁹**

- Kit Includes: Inspection Lamp, EZ-Shot A/C Dye Injection Gun, R134a Hose and Coupler with R-12 Adapter/Purge Fitting, 8 Oz. BigEZ™ Universal Dye Cartridge for All A/C Systems, 8 Oz. Spray Bottle of GLO-AWAY™ Dye Cleaner, Fluorescence-Enhancing Glasses, Underhood Labels and Plastic Carrying Case



Professional UV Leak Detection Kit with 12V/50W UV Light

SKU 290041
MSC53351 **84⁹⁹**

- 12 Volt / 50 Watt UV Leak Detector
- 1 Ounce Coolant Dye, 1 Ounce Oil/ATF/Fuel Dye, Dye Remover
- Mini Dye Injector (10 Applications of Universal A/C Dye) Which is compatible with R134a and R12 Adapter
- UV Enhancing Safety Glasses
- 12 Service Labels



A/C Refrigerant Leak Detector

SKU 466307
24510 **79⁹⁹** REG. \$99.99

- Detects All Types of Halogenated Refrigerants
- Sensitive to 0.1 Oz./Yr.
- Single Color LED Display with 7 Level Leak Alarm
- Flexible Stainless Steel Probe to Reach to Almost Any Space
- Includes Spare Sensor Tip



SAVE \$20

Offer Good Through June 30, 2017 - While Supplies Last

IntellaSense II Refrigerant Leak Detector

SKU 695639
MSC55900 **299⁹⁹**

- Detects: Combustible Gases, Hydrogen, Refrigerants (all CFC's, HCFC's and HFC's)
- Includes Leak Test Vial and Replacement Filters in a Blow Molded Box
- Meets and Exceeds J2791 and J2913



Nitrogen Leak Test Kit

SKU 295560
MSC53010 **299⁹⁹**

- T-Handle for Ease of Pressure Adjustment Kit
- Includes Leak Testing Gauges and Hoses



Electronic Leak Detector with 3 Sensitivity and 5 Detection Levels

SKU 290030
MSC55100 **199⁹⁹**

- Detects All Refrigerants (CFC's, HCFC's, HFC's)
- Meets and Exceeds SAE J1627



"Inspector" 2-in-1 Electronic/UV Leak Detector

SKU 290031
MSC55200 **199⁹⁹**

- Pinpoint Leaks as Small as 1/10 Oz. (3 gr) per Year
- Ultra Bright UV Light is Built Into the End of the Probe, Allowing Easy Access Into Tight Areas



Identifier

Refrigerant Identifier for R134a

SKU 295556
MSC69134-A **699⁹⁹**

- Avoid Potential Damage from Refrigerant Contamination
- Automatically Provides Step-by-Step Indication of the Gas Sampling Process
- Accuracy: Pass/Fail - 95% Pure R134a



Injectors

In-Line Dye and Oil Injector

SKU 466322
24532 **39⁹⁹**

- Add Up to 2 Oz. of Oil or Dye to a System Under Vacuum or While Adding Refrigerant
- 1/2" ACME Fittings to Fit Most R134a Systems
- Use with TRATP38400601 Bottle Fluoro-Lite® Universal A/C Dye



EZ-Ject™ R-1234yf/PAG A/C Dye Injection Kit - Professional Grade!

SKU 568721
TRATP9844 **84⁹⁹**

- Multi-Dose Cartridge Prefilled with R-1234yf/PAG A/C Fluorescent Dye
- Easily Overcomes System Pressure, Dye Can Be Injected While System is Off or Running
- EZ-Ject R-1234yf/PAG A/C Dye Cartridge, Services Up to 14 Vehicles



R12 and R134a Hand Turn Dye Injector

SKU 466320
24528 **69⁹⁹**

- Injects Dye or Oil Into R12 or R134a Systems
- Refillable, Capacity: 2 Oz.
- Includes R134a Quick Coupler
- Use with TRATP38400601 Bottle Fluoro-Lite® Universal A/C Dye



EZ-Shot™ Universal A/C Dye Injection Kit - Universal and Economical!

SKU 568723
TRATP9790 **144⁹⁹**

- EZ-Shot Quickly Introduces Dye Into a Vehicle's A/C System
- BigEZ™ Cartridges Are Prefilled with Co-Solvent Free A/C Dye, Certified to Meet SAE J2297 and Calibrated For Exact Dosing
- BigEZ 8 Oz. Universal Dye Cartridge Services Up to 64 Vehicles



Leak Detection Fluid

1 Oz. Bottle Dye-Lite™ All-In-One™ Oil Dye (6 Pack)

SKU 291395
TRATP3405 **29⁹⁹**

- Patented Formulation Works with any Leak Detection Lamp



1 Oz. Bottle Fluoro-Lite® Universal/POE A/C Dye (6 Pack)

SKU 291398
TRATP38400601 **54⁹⁹**

- Pourable Dye for Use with Many Dye Injectors or Simply Pour Into an Open System
- Includes 4 Applications for Standard Sized Systems



BigEZ™ 8 Oz. Universal Dye Cartridge

SKU 291396
TRATP97700108 **64⁹⁹**

- Treats Up to 64 Vehicles
- Fits Most Caulking Gun Injectors Including TRATP9790



Universal Concentrated Dye Cartridge - 1 Oz. (5 Pack)

SKU 505040
MSC53810-5 **94⁹⁹**

- 5 Pack of Dye for 53585 Leak Detector Kit
- 10 Applications per Bottle



Leasing Terms Available!†

Ask Your AutoZone®
Commercial Sales Manager

AutoZone®
Tool & Equipment QUARTERLY

A/C Hose and Line Repair

Line Splice Straight Repair Kit



- Effective, Durable Leak Repair with No Line Removal
- 5 Minute Install with a Wrench (No Special Tools, No Adhesives Required)
- High-Tech Anti-Vibration Tension Ring Ensures Durability in Tough Automotive Applications
- HNBR Seal Sleeve Dramatically Expands the Sealing Surface Area
- Burst Tested to 2600 PSI



SKU	Part #	Size	Price
SAE			
504140	AIR76003	5/16" Line	\$29.99
504138	AIR76002	3/8" Line	\$29.99
504136	AIR76001	1/2" Line	\$29.99
504143	AIR76011	5/8" Line	\$39.99
504145	AIR76012	3/4" Line	\$39.99
METRIC			
504132	AIR77008	8 mm Line	\$29.99
504155	AIR77010	10 mm Line	\$29.99
504156	AIR77012	12 mm Line	\$29.99
504133	AIR77015	15 mm Line	\$39.99
504117	AIR77016	16 mm Line	\$39.99

Smart Splice™ Straight Connectors

- When a Metal-to-Rubber A/C Line is Damaged, You Often Must Replace the Complete OE Line. If the Line is Not in Stock Locally, You Inconvenience Your Customer by Waiting for a Replacement Line. Quickly and Easily Connect A/C Reduced Barrier Hose to Metal Line Using AirSept's Smart Splice Line-to-Hose Connector™.
- Leak-Proof Line Splice™ Technology on the Metal Side of the Connection
- Superior Hose Crimp Technology on the Rubber Side
- Works for Heater and Coolant Lines Also
- Install in 5 Minutes



SKU	Part #	Size	Price
504125	AIR76701	1/2" Line to #8 Hose	\$29.99
504128	AIR76702	3/8" Line to #6 Hose	\$29.99
504129	AIR76703	5/16" Line to #6 Hose	\$29.99
504130	AIR76704	5/8" Line to #10 Hose	\$39.99
504131	AIR76705	3/4" Line to #12 Hose	\$39.99

Line Splice Straight Repair Kit Reducer

- Effective, Durable Leak Repair with No Line Removal
- 5 Minute Install with a Wrench (No Special Tools, No Adhesives Required)
- High-Tech Anti-Vibration Tension Ring Ensures Durability in Tough Automotive Applications
- HNBR Seal Sleeve Dramatically Expands the Sealing Surface Area
- Burst Tested to 2,600 PSI
- Works on Heater and Coolant lines



SKU	Part #	Size	Price
504141	AIR76004	3/8" to 5/16" Line	\$29.99
504095	AIR76005	1/2" to 5/16" Line	\$29.99
504142	AIR76006	1/2" to 3/8" Line	\$29.99

Line Terminator Rear A/C Blockoff Kits



- OE-Approved Rear A/C Block-Off Kits Block Damaged or Unused A/C Lines — No Line R and R. Save Time and Satisfy Customers. Leaking Rear A/C Components or Lines Can Result in High Operating or Repair Costs. Many Car Owners Would Rather Avoid That Expense and Operate the Front A/C Unit Only. With AirSept's Line Terminator, You Can Give Your Customers an Affordable (Yet Still Profitable) Alternative to the High Cost of Repair or Replacement Labor.
- Quickly and Effectively Blocks A/C Lines at the Damage Point or at the Front System "Y"
- Block-Off Leaking Rear Evaporators and Failed System Components
- Help Maximize Front A/C Performance
- Eliminate Refrigerant and Oil Pooling in Rear A/C Lines

SKU	Part #	Size	Price
504150	AIR76503	5/16" Line	\$22.99
504149	AIR76502	3/8" Line	\$22.99
504146	AIR76501	1/2" Line	\$22.99
504152	AIR76504	5/8" Line	\$26.99
504154	AIR76505	3/4" Line	\$31.99

Manual Style A/C Hose Crimper, Bench or Vise Mounted

SKU 290028
MSC71550 **244⁹⁹**

- The 71550 is Our "Manual Style" A/C Hose Crimper. The Dies Snap Quickly into Place Requiring No Pins or Screws. The Unit Can Be Easily Mounted to a Bench Using the Holding Fixture or Held Securely in a Vice. This Kit Comes with a Complete Set of Dies Covering Standard Hose Sizes #6, #8, #10 and #12.
- Includes: 71500 - 001 Yoke Assembly, 71550 - 002 Arbor Assembly, 71550 - 003 Holding Fixture Assembly, 71500 - 6 Die Set - #6 (5/16 In.), 71500 - 8 Die Set - #8 (13/32 In.), 71500 - 10 Die Set - #10 (1/2 In.), 71500 - 12 Die Set - #12 (5/8 In.), and 71500-PB Custom Mold Box Carrying Case



Hydra-Krimp A/C Hose Crimping Tool

SKU 290027
MSC71500 **749⁹⁹**

- Repair A/C Hoses On or Off the Vehicle
- Includes a Complete Set of Dies Covering Hose Sizes: #6, #8, #10, #12; and Reduced Barrier: #6, #8, #10 and #12
- Dies Snap Quickly Into the Press Fixture (no Pins or Screws Required)
- Patented, Lightweight, Portable
- Ideal for Shop and Field Applications



Heavy Duty Ratcheting Hose Cutter

SKU 466311
24522 **16⁹⁹**

- Smooth Action and High Quality Blade Provide Quick, Clean and Accurate Cuts
- Cuts Rubber Hose and PVC Up to 1-1/2" OD
- Ratcheting Action Makes it Faster and Easier to Use Than Other Cutters
- Wide Hooked Jaws Hold Tubing Securely



Line Terminator SAE - 5 Pack

SKU 504122
AIR76526 **89⁹⁹**

- Quickly and Effectively Blocks A/C Lines at the Damage Point or at the Front System "Y"
- Block Off Leaking Rear Evaporators and Failed System Components
- Includes One Each: 5/16", 3/8", 1/2", 5/8" and 3/4" SAE Kits



Line Terminator SAE/Metric - 10 Pack

SKU 504124
AIR76530 **179⁹⁹**

- Quickly and Effectively Blocks A/C Lines at the Damage Point or at the Front System "Y"
- Block Off Leaking Rear Evaporators and Failed System Components
- Includes One Each: 5/16", 3/8", 1/2", 5/8" and 3/4" SAE Kits; Plus One Each: 8 mm, 10 mm, 12 mm, 15 mm and 16 mm Metric Kits



Line Splice Straight SAE (5 Pack)

SKU 504101
AIR76050 **139⁹⁹**

- Effective, Durable Leak Repair with No Line Removal
- OE Approved
- 5 Minute Install - No Special Tools
- Includes One Each: 5/16", 3/8", 1/2", 5/8" and 3/4" Line Splice Kits



Line Splice Straight SAE/Metric - 10 Pack

SKU 504103
AIR76051 **269⁹⁹**

- Effective, Durable Leak Repair with No Line Removal
- OE Approved
- 5 Minute Install - No Special Tools
- Includes One Each: 5/16", 3/8", 1/2", 5/8" and 3/4" SAE Line Splice Kits; Plus One Each: 8 mm, 10 mm, 12 mm, 15 mm and 16 mm Metric Line Splice Kits



R134a / R12 Charging Hose Repair Kit

SKU 295557
MSC91334-A **44⁹⁹**

- 55 Piece Assortment of Replacement Gaskets, O-rings, Depressors for Charging Hoses and Adapters



Airsept Smart Splice™ Ultimate Line Repair Kit

SKU 687976
AIR76057 **1,769⁹⁹**

- Everything Needed to Repair A/C, Power Steering Return, Transmission, Trans Oil Cooler, Engine Oil, Engine Oil Cooler, Coolant and Heater Lines
- OEM Approved Line Repair Solution Installs in Five Minutes, on the Vehicle, Without Special Tools or Adhesives
- Leak Free Up to 2600 PSI



Airsept Smart Splice™ Multi-System Line Repair Tray

SKU 687973
AIR76076 **524⁹⁹**

- Includes One Each: 5/16", 3/8", 1/2", 5/8", 3/4" Line Splice Straight SAE Repair Kits; 8 mm, 10 mm, 12 mm, 15 mm, 16 mm Line Splice Straight Metric Repair Kits; 5/16", 3/8", 1/2", 5/8" Line Splice 45° SAE Repair Kits; 5/16", 3/8", 1/2", 5/8" Line Splice 90° SAE Repair Kits
- Top Tray in Master Cabinet



Airsept Smart Splice™ Line Terminator and Service Tee Repair Tray

SKU 687974
AIR76077 **499⁹⁹**

- Everything Needed to Block Off A/C, Coolant and Heater Lines, or Add an A/C Service Port
- SAE Sizes (OD Metal Lines): 5/16", 3/8", 1/2", 5/8", 3/4" OD Metal Lines
- Metric Sizes (OD Metal Lines): 8 mm, 10 mm, 12 mm, 15 mm, 16 mm



Airsept Smart Splice™ Hose to Tube, Hose to Hose Repair Tray

SKU 687975
AIR76078 **549⁹⁹**

- Everything Needed to Make Hose to Line or Hose to Hose Repairs on A/C, Coolant and Heater Lines
- SAE Sizes (OD Metal Lines): 5/16", 3/8", 1/2", 5/8", 3/4" OD Metal Lines, SAE Sizes for #6, #8, #10, #12 3/4"; A/C Reduced Barrier Hose



Airsept Smart Splice™ Aluminum Tube Insert Service Tray

SKU 687989
AIR76079 **219⁹⁹**

- Repair Long Sections of Damaged or Leaking A/C, Power Steering Return, Transmission, Trans Oil Cooler, Engine Oil, Engine Oil Cooler, Coolant and Heater Lines.
- Includes 12' Lengths of Aluminum Tubing for SAE and Metric Lines



Airsept 5 Piece Smart Splice™ Tool Assortment

SKU 688003
AIR76080 **159⁹⁹**

- Includes: Deburring Tool, Tube Cutter, Caliper, Pex Crimper, Rubber Hose Crimper

AIR CONDITIONING

RECOVERY / RECYCLE / RECHARGE MACHINES

ROBINAIR



SKU 221185
ROB34288

2,899⁹⁹



SKU 751569
ROB34788NI

3,799⁹⁹



SKU 751572
ROB34788NI-H

3,899⁹⁹



SKU 377607
ROB34988NI

4,899⁹⁹



SKU 751575
ROBAC1234-6

6,399⁹⁹

Features	ROB34288	ROB34988NI	ROB34788NI	ROB34788NI-H	ROBAC1234-6
Fully-Automatic Function: Program to recover, vacuum, leak test and charge without operating panel valves.		X	X	X	1234YF A/C Service
Automatic Dye Inject: Gives the user the ability to use the machine to inject UV dye into a vehicle's A/C system.		X			• Fully automatic operation — program for service, walk away and return when complete.
Automatic Oil Drain: A display reminds you to empty the graduated container to show the amount of oil to replace.	X	X	X	X	• 95% recovery efficiency.
Oil Inject: Automatically inject oil back into the vehicle's A/C systems.		X*	X		• Programmable vacuum operation helps get to the necessary vacuum level in any condition quickly.
Refrigerant and Oil Database: A/C system capacities for North American market vehicles (Optional – not included with the machine).		Optional	Optional	Optional	• System leak test to identify gross leaks in a system.
A/C System Flush: Flushes a vehicle's A/C system with refrigerant, eliminating any residual oil or other liquid (Flushing adapters not included).		X	X	X	• Charge accuracy within +/- 1/2 oz.
Save and Print Before and After Service Data: Allows the user to store before and after service information by vehicle and print this information to provide to a customer.		X	X	X	• Automatic oil drain shows how much oil was removed from the system during service.
Visual and Audible Alarm: Notifies the user when service is complete, or if a problem has occurred.		X	X	X	• Automatic air purge removes the potential of air accumulating in the internal tank.
Vacuum Leak Test: Monitors level after evacuation, informs of possible leak.	X	X	X	X	• Integrated refrigerant identifier (meets SAE J2927).
Automatic Air Purge: Eliminates system-damaging air without monitoring gauges or opening valves.	X	X	X	X	• Liquid refrigerant flushing function can flush A/C systems or individual components using liquid refrigerant instead of harsh chemicals.
Automatic Refrigerant Refill: Maintains a user-selectable amount of refrigerant in an internal vessel and signals when it's time to change supply tank, no monitoring required.		X			• Automatic internal tank refill. No stopping to fill the internal tank during service, or before service.
Vacuum Feature: Defaults to 15 mins, programmable up to 99 mins. "Remaining time" is displayed.		X	X	X	• 1/4 Color VGA display. Large easy-to-read graphical display.
Display: Multilingual.	X	X	X	X	• On-board printer capable of printing vehicle service report slips to present to customers.
Refrigerant Charging: Select a charge mode from high or low side, or use both sides.		X	X	X	
Refrigerant Management System: Displays refrigerant use and monitors remaining filter life. Prompts appear when 1/3 of filter life remains.	X	X	X	X	
Electric Vehicle: Capable of servicing high voltage electric compressor A/C systems.					X
Printer		X	Optional	Optional	
Refrigerant Identifier			Optional	Optional	

* 34988NI has (2) oil bottles for injection, giving the technician the option to choose between two on-board oils to service the vehicle • Large full color display (34988 has monochrome display) • 34988NI meets SAE J2788 requirements, consistently meets 98.5% recovery performance vs 95% on the 34988

Refractometers

OTC

OTC UREA DEF Refractometer

SKU 471112
OTC5025 **99⁹⁹**

- Def-Unique Calibrated Scale with 32.5%
- Enables Operators to Clearly Determine if the Def in their Vehicle Consists of a 32.5% Urea / Water Solution
- 15-40% Variance on Scale
- 0.5% Line Graduations
- Complete Kit Provides Operators Everything They Need to Calibrate and Use Def Refractometer



OTC

Robinar Coolant and Battery Refractometer

SKU 471116
ROB75240 **59⁹⁹**

- Can Be Used for Measuring the Freezing Point of Either Propylene or Ethylene Glycol Based Cooling Systems
- Can Also Be Used for Checking the Strength of Electrolyte Solution Batteries
- This Precision Instrument Features High-Quality Optics with Ultra-Smooth Focusing
- Scale Range: -60° F To 32° F.



Spring Compressor

OTC

StrutTamer II Extreme with Stand

SKU 471100
OTC6637-ST **899⁹⁹**

- Meets the New ASME PASE Standards for Spring Compressors
- Capable of Safely Compressing the Largest Strut Springs
- New Forged Locking Jaws Include Larger Pads and Offset to Clamp Onto and Compress Springs Even Tighter Than Before
- Unique Trunnion Locking Mechanism to Eliminate Arm Movement for Stable Compression



Leasing Terms Available!†

Ask Your AutoZone®
Commercial Sales Manager

AutoZone®
Tool & Equipment QUARTERLY

Engine Service



Ford Spark Plug Remover Kit, Triton 3V

SKU 087307 **99⁹⁹**
OTC6918

- Unique Design Helps Prevent Breakage by Locking the Plug Porcelain Core to the Plug Hex Allowing it to Turn as One Complete Unit
- Will Also Pull Plug Porcelain Core if Only Plug Hex is Removed
- Detailed Instructions to Maximize Success Rate



Works on:

- Ford 4.6L 3V V8 Engines Used in 2005-2008 Mustang, 2006-2008 Explorer
- Ford 5.4L 3V V8 Engines Used in 2004-2008
- F-Series, 2005-2008 Expedition, 2005-2008 Lincoln Navigator
- Ford 6.8L 3V V10 Engines Used in 2005-2008 F-Series 250-350-450



Belt Holding Tool

SKU 087299 **19⁹⁹**
OTC7424

- Keeps Belt from Falling Off of a Pulley During Belt Installation
- Universal Design to Fit Most Pulley Styles and Sizes
- Super Strong Magnet to Hold the Belt Firmly On the Pulley
- Multiple Holders Can Be Used for Belt Applications that Fit Around Many Pulleys
- Durable Plastic Housing with Magnet for Steel/Iron Pulley Applications



Chassis Service



Ball Joint Intermediate Service Kit

SKU 087302 **349⁹⁹**
OTC6530

- This 20+ Adapter Kit Covers Many Truck/Van/SUV Applications and Some Car Applications
- With the Majority of Cars and Truck/Van/SUV Applications Having Press-In Ball Joints and Universal Joints, This Kit is Designed to Service Many of Those Applications
- This Kit is a Combination of 7249, 7918, and 7996 Kits, and Includes 20+ Adapters, C-Frame, and Application Diagrams All Provided in a Case



Specialty Tools



Master TORX® Socket Set

SKU 087309 **97⁹⁹**
OTC5900A

52 Piece, Professional Socket Set in a Blow-Molded Case. Hundreds of Applications from Front to Rear on Cars and Trucks:

- Seat Belt Bolts
- Interior and Exterior Trim Screws
- Engine Assemblies
- Tail Lamp Lenses and Assemblies
- Bumpers
- Headlight Bezels
- Door Strikers and Latches
- Brake Rotor Bolts
- GM Front-Wheel Drive Front Wheel Bearings
- Truck Box Liners

- Styles Available: TORX, TORX PLUS, Tamper-Resistant TORX and External TORX
- Made from Superior S2 Steel to Meet or Exceed Torque Specifications



CrimPro™ 4-in-1 Angled Wire Tool

SKU 087314 **29⁹⁹**
OTC5950A

- Compact 7" Design
- Gripping Nose
- Crimper, 12-20 AWG Insulated and Non-Insulated Wire
- Stripper – Strips 12-20 AWG Wire
- Cutter – Ability to Make Cuts Both Above and Below Pivot



CrimPro™ 4-in-1 Wire Tool

SKU 087317 **25⁹⁹**
OTC5950S

- Compact 7" Design
- Gripping Nose
- Crimper, 12-20 AWG
- Insulated and Non-Insulated Wire
- Stripper – Strips 12-20 AWG Wire
- Cutter – Ability to Make Cuts



Brake and Driveline Service



9-Way Slide Hammer Puller Set

SKU 087303 **99⁹⁹**
OTC4579

- Pulls Flange-Type Rear Axles and Most Front-Wheel Drive Hubs
- Internal and External Jaws Provide a Variety of Combinations to Pull Bearings, Gears and Seals
- 5 Lb. Slide Hammer
- Two- and Three-Way Cross Blocks and Cone Provide the Perfect Jaw Configuration for Most Jobs
- Set Also Includes a Grip Wrench Adapter and a Dent Puller Attachment for Sheet Metal or Other Unique Pulling Requirements
- Designed for Use with Other OTC 5/8"-18 Thread Slide Hammer Attachments
- Packaged in Blow-Molded Case



Bearing Splitter Combo Set

SKU 087318 **349⁹⁹**
OTC1183

This Combo Pack Contains Four of OTC's Most Popular Bearing Splitters, Plus a Pulley Pulling Attachment. A Rugged Organizer Case is Included, Enabling You to Keep the Tools Together for Instant Use.



OTC Brake Drum & Rotor Puller

SKU 087311 **139⁹⁹**
OTC6980

- Handles Large Components Such as Brake Drums, Rotors, Drive Gears, Flywheels, and Pulleys
- One Person Can Easily Set the Tool in Place and Use for Tough Pulls Even Where There is Little Access to Insert the Jaws
- Spread to 12-3/4" and 5" of Reach
- 7-Tons of Force, Yet Weighs Less Than 10 Lbs.
- Can Be Used with Air Tools to Reduce Time and Fatigue



OTC Hub Grappler™

SKU 096847 **609⁹⁹**
OTC6575

- The Hub Grappler Kit is the Complete Solution for Servicing Wheel Hubs and Bearings on the Vehicle without Removing the Steering Components or Knuckle. This Eliminates Unnecessary Alignments or the Use of a Shop Press, Cutting Service Time Dramatically.
- The New Hub Grappler Puller is Specifically Designed to Apply Maximum Force with Minimal Effort from an Impact Gun to Also Minimize Service Time
- The New Jaws are Designed and Sized to Properly Fit Hub Applications and Can Be Quickly Located on the Puller Bar without the Use of Fasteners
- The New 3/4" Custom Drive Screw Coupled with the Special Equalizer Washer Provides Smooth Operation While the Proprietary Heat Treating Extends its Life 5-10 Times Longer Than Similar Designs
- 6 New Adapters Increases Application Coverage Up to 2009 Model Year. Also Includes Tie Rod/Ball Joint Tool and 2 Ford Axle Installers
- The Hub Grappler Application Guide is the Most Comprehensive Hub and Bearing Service Guide on the Market. Developed to Be the First Tool Used in the Kit, it Provides Quick Reference to the Other Tools in the Kit Required to do the Job, Eliminating Guesswork and Saving Time



TIRE SERVICE



Contact Us:
1-877-AZTool1 Phone
 (1-877-298-6651) *Hablamos Español*

SAVE ON COMBO OFFERS!

Complete Tire and Wheel Service

geodyna® 7100 Balancer and monty® 1270 Tire Service Combo

SKU 339014
 HOFCOMBO1TS **3,999⁹⁹**

- Save with This Great General Service Tire Service Combo
- Includes monty 1270 Tire Changer with Outer Clamping Up To 20" and the geodyna 7100 Wheel Balancer with Belt-Driven One-Spin Balance, VPM Measuring System, User-Friendly 2D SAPE Data Entry and Intuitive Control Panel



HOFEEWB761AE1



SAVE \$389⁹⁹



HOFEEWH764AU1

Price Does Not Include Tires or Rims as Shown

User Set-Up Required

HOFCOMBO1TS		\$3,999.99
HOFEEWH764AU1	monty 1270 Tire Changer	\$2,224.99
HOFEEWB761AE1	geodyna 7100 Wheel Balancer	\$2,164.99
	Total	\$4,389.98
	Savings	\$389.99

Warranty 90 Days Parts and Labor

Lift Gate Service SKU 290017 HOFLIFTGATE **95⁰⁰**

Dannmar® T-100 Tire Changer and B-100 Wheel Balancer Combo

SKU 818788
 DAN1381801 **2,799⁹⁹**

- Includes: DAN1381201 Dannmar T-100 Tire Changer and DAN1381202 Dannmar B-100 Wheel Balancer
- This Dannmar Combo is Best Suited for Gas Stations, Small Garages and Auto Salvage Yards. With the T-100 B-100 Combo, You Get Great Value and More Bang for Your Buck.
- T-100 - Outside Clamp: 12" - 22"
- B-100 - Rim Diameter: 1" - 28"
- B-100 Includes Data Acquisition Wand and Quick Nut
- 1 Year Parts Only Warranty

Price Does Not Include Tires or Rims as Shown



DAN1381201



SAVE \$249⁹⁹

DAN1381202



User Set-Up Required

DAN1381801		\$2,799.99
DAN1381202	Dannmar T-100 Tire Changer	1,599.99
DAN1381201	Dannmar B-100 Balancer	\$1,449.99
	Total	\$3,049.98
	Savings	\$249.99

Warranty 1 YEAR Parts Only

Lift Gate Service SKU 262534 DANLIFTGATE **100⁰⁰**

Ranger® Tire Service Package

SKU 851131
 RANCOMBO1 **3,959⁹⁹**

- Includes: R980XR NEXTGEN™ Swing-Arm 25" Tire Changer and the DST-2420 Dynamic Wheel Balancer
- R980XR External Rim Clamping Capacity: 9" - 28"
- DST-2420 Dynamic Wheel Balancer Dependably Ensures an Accurate Result within Hundredths of an Ounce

User Set-Up Required



RANDST2420

Price Does Not Include Tires or Rims as Shown

SAVE \$79⁹⁹



RANR980XR

COMES WITH: Wheel Weight Starter Kit #5150235 Includes: 100 piece silver roll and 100 piece black roll **\$74³⁸** Value

RANCOMBO1		\$3,959.99
RANDST2420	DST-2420 Tire Balancer	\$1,764.99
RANR980XR	NEXTGEN 23" Tire Changer	\$2,274.99
	Total	\$4,039.98
	Savings	\$79.99

Dual Position RimGuard™ Wheel Clamps

Lift Gate Service SKU 262533 RANLIFTGATE **135⁰⁰**

Coats® RC-55E and 1300 Series Tire Service Combo

SKU 597289
 AMMCOMBO2 **9,649⁹⁹**

- RC-55E Features an External Clamping Range from 6" to 24" (Max Tire Diameter 50"; Max Rim Width 10-1/2")
- RC-55E Drive System: 1 HP Electric Motor
- Tire Changer Allows Inflation from 0 to 60 PSI with a Built-in Pressure Limiter
- 1300 Series Wheel Balancer is Powered by Direct Drive
- Static-On-Screen® Display Identifies Any Excess Residual Static Imbalance
- Wheel Balancer Automatically Enters 2-D Data for Wheel Diameter and Offset Measurement

Price Does Not Include Tires or Rims as Shown



AMM80013002D

SAVE \$219⁹⁹



AMM8560995001

AMMCOMBO2		\$9,649.99
AMM8560995001	RC-55E Tire Changer	\$5,199.99
AMM80013002D	1300 2D Wheel Balancer	\$4,669.99
	Total	\$9,869.98
	Savings	\$219.99

INCLUDES Manufacturer's Set-Up and Training

Lift Gate Service SKU 262529 AMMLIFTGATE **55⁰⁰**

BaseLine™ BL300 Tire Changer and 350 Balancer Combo

SKU 435488
 AMM8500300350 **3,999⁹⁹**

- Includes: BL300 Tire Changer and 350 Balancer
- 10 - 24" External Clamping Capacity
- Bead Sealing Jets to Aid Inflation
- 350 Balancer Features Self Diagnosis and Calibration
- One Button Split and Hidden Weight Program

Lift Gate Service SKU 262529 AMMLIFTGATE **55⁰⁰**

INCLUDES Manufacturer's Set-Up



AMM85002300

AMM85002350

SAVE \$199⁹⁹



AMM8500300350		\$3,999.99
AMM85002300	BL300 Tire Changer	\$2,099.99
AMM85002350	BL350 Wheel Balancer	\$2,099.99
	Total	\$4,199.98
	Savings	\$199.99

Comes with 1 Year Parts Warranty

BaseLine™ BL500 Tire Changer and 550 Balancer Combo

SKU 435489
 AMM8500500550 **5,199⁹⁹**

- Includes: BL500 Tire Changer and 550 Balancer
- 10 - 24" External Clamping Capacity
- Bead Sealing Jets to Aid Inflation
- 550 Balancer Features Automatic Distance and Diameter Entry
- Direct Weight Location

Lift Gate Service SKU 262529 AMMLIFTGATE **55⁰⁰**

INCLUDES Manufacturer's Set-Up



AMM85002500

AMM85002550

SAVE \$399⁹⁹



AMM8500500550		\$5,199.99
AMM85002500	BL500 Tire Changer	\$2,799.99
AMM85002550	BL550 Wheel Balancer	\$2,799.99
	Total	\$5,599.98
	Savings	\$399.99

Comes with 1 Year Parts Warranty

Leasing Terms Available!†

Ask Your AutoZone®
Commercial Sales Manager

AutoZone®
Tool & Equipment QUARTERLY

Tire Changers



TOP SELLER



Tilt Back Tire Changer / 30" Capacity NextGen™ Series

SKU 544546 RANR76LT **2,269⁹⁹**

- Drive System Type: Electric/Air
- Motor: 2 HP (110 - 220VAC, 50 - 60 Hz)
- Air Requirement: 110 - 175 PSI (8 - 12 Bar)
- External Rim Clamping Capacity: 9" - 28"
- Internal Rim Clamping Capacity: 10" - 30"
- Table Clamping System: Dual Pneumatic Cylinders
- Bead Breaking System: Pneumatic Blade
- Tower Design Tilt-Back



Lift Gate Service
SKU 262533
RANLIFTGATE **135⁰⁰**

User Set-Up
Required

Swing Arm Tire Changer / 30" Capacity NextGen™ Series

SKU 312817 RANR980XR **2,274⁹⁹**

- Drive System Type: Electric/Air
- Motor: 2 HP (110/208 - 240VAC, 50 - 60 Hz)
- Air Requirement: 140 - 165 PSI (10 - 11 Bar)
- Bead Breaker Tire Width Capacity Demount: 1.5" - 16" (38 mm - 406 mm)
- Internal Rim Clamping Capacity: 10" - 30" (254 mm - 762 mm)
- External Rim Clamping Capacity: 9" - 28" (229 mm - 711 mm)
- Bead Seating System: Turbo Blast/Bead Seating



Dual Position
RimGuard™
Wheel Clamps

Lift Gate Service
SKU 262533
RANLIFTGATE **135⁰⁰**

User Set-Up
Required

Swing Arm Tire Changer 30" Capacity NextGen™ Series

SKU 544590 RANR980XRF **2,599⁹⁹**

- 2 HP, (208 - 240V, 50 - 60 Hz, 1 Phase Only)
- Internal Rim Clamping Capacity: 10" - 30"
- Maximum Tire Diameter: 50"



Features True
Variable Speed
Control

Lift Gate Service
SKU 262533
RANLIFTGATE **135⁰⁰**

User Set-Up
Required

Swing Arm Tire Changer / Single Tower Assist / 30" Capacity NextGen™ Series

SKU 544537 RANR980AT **3,349⁹⁹**

- Motor: 2 HP (110/208 - 240V, 50 - 60 Hz)
- External Rim Clamping Capacity: 9" - 28"
- Internal Rim Clamping Capacity: 10" - 30"
- Maximum Tire Diameter: 50"



Features True
Variable Speed
Control

Price Does Not
Include Tires or
Rims as Shown

Lift Gate Service
SKU 262533
RANLIFTGATE **135⁰⁰**

User Set-Up
Required

Swing Arm Tire Changer / Single Tower Assist / Variable Speed / 30" Capacity NextGen™ Series

SKU 544547 RANR980NXTF **3,699⁹⁹**

- 2 HP (208 - 240V, 50 - 60 Hz, 1 Phase Only)
- External Clamping (Outer): 9" - 28"
- Maximum Tire Diameter: 50"



Features True
Variable Speed
Control

Lift Gate Service
SKU 262533
RANLIFTGATE **135⁰⁰**

User Set-Up
Required

RimGuard™ 28" Swing-Arm and Single Power Assist Tire Changer

SKU 544542 RANR980ATF **3,599⁹⁹**

- 2 HP (208 - 240V, 50 - 60 Hz, 1 Phase Only)
- External Rim Clamping Capacity: 9" - 28"
- Internal Rim Clamping Capacity: 10" - 30"
- Maximum Tire Diameter: 50"



Features True
Variable Speed
Control

Price Does Not
Include Tires or
Rims as Shown

Lift Gate Service
SKU 262533
RANLIFTGATE **135⁰⁰**

User Set-Up
Required

Tilt Back Tire Changer / Right Tower Single Assist / 30" Capacity NextGen™ Series

SKU 544543 RANR76ATR **3,599⁹⁹**

- External Rim Clamping Capacity: 9" - 28"
- Internal Rim Clamping Capacity: 10" - 30"
- Maximum Tire Diameter: 43"
- Alloy Steel Mount and Demount Head, Nylon Tool Head Also Comes Standard



Tilt-Back 28" with Assist Tower Tire Changer

SKU 544550 RANR76ATRF **3,999⁹⁹**

- 2 HP (208 - 240V, 50 - 60 Hz, 1 Phase Only)
- External Rim Clamping Capacity: 9" - 28"
- Internal Rim Clamping Capacity: 10" - 30"
- Maximum Tire Diameter: 43"

Features True
Variable Speed
Control

Lift Gate Service
SKU 262533
RANLIFTGATE **135⁰⁰**

User Set-Up
Required

Swing Arm Tire Changer / Single Tower Assist / 32" Capacity NextGen™ Series

SKU 312819 RANR30XLT **3,849⁹⁹**

- Internal Rim Clamping Capacity: 13" - 33"
- External Rim Clamping Capacity: 10" - 28"
- Turntable Tire Width Capacity Mount: 5" - 22"
- Bead Breaker Tire Width Capacity Demount: 3" - 15"
- Maximum Tire Diameter: 50"



Price Does Not
Include Tires or
Rims as Shown

Lift Gate Service
SKU 262533
RANLIFTGATE **135⁰⁰**

User Set-Up
Required

Tire Changers



monty® 1270 Tire Changer

SKU 339003 HOFEEWH764AU1 **2,224⁹⁹**

- Outside Clamping Capacity: 20"
- Mounting Arm Swings to the Side So the Machine Can Be Installed Near the Wall to Save Space
- Includes: Oiler, Water Separator, Manual Tire Inflator

User Set-Up
Required

Warranty
90 days parts/labor

Lift Gate Service
SKU 290017
HOFLIFTGATE **95⁰⁰**



monty® 1520 20" Capacity Tire Changer

SKU 290001 HOFM1520110 **3,899⁹⁹**

- Overall Wheel Clamping Diameter 10" - 20"
- Two Stage Bead Breaker Range 2" - 13"
- Dual Pneumatic Clamping Cylinders Control All Four Clamping Jaws, Eliminating Damage to Wheels Due to Slippage
- Powerful Tire Inflation System - Each Moveable Jaw is Precisely Set to the Exact Position Under the Wheel to Seal the Tire Bead

INCLUDES
On-Site Factory
Authorized Training

Lift Gate Service
SKU 290017
HOFLIFTGATE **95⁰⁰**

Warranty
5 year transmission
3 year motor 1 year standard parts
6 months labor



Price Does Not
Include Tires or
Rims as Shown

monty® 1575 Tire Changer

SKU 849298 HOFMONTY1575B **4,399⁹⁹**

- Ideal for Shops Looking for Great Value without Sacrificing Productivity
- Outer-Wheel Diameter of 24"
- Accommodates Tire Diameter of 39"
- Powerful Inflation System

INCLUDES
On-Site Factory
Authorized Training

Lift Gate Service
SKU 290017
HOFLIFTGATE **95⁰⁰**

Warranty
5 year transmission
3 year motor 1 year standard parts
6 months labor



Price Does Not
Include Tires or
Rims as Shown



monty® 1625 Tire Changer

SKU 849300 HOFMONTY1625B **5,649⁹⁹**

- Designed for High-Volume Tire Shops, Multi-Bay Repair Shops and Car Dealerships
- Outer-Wheel Diameter of 24"
- Inner-Wheel Diameter of 26"
- Accommodates Tire Diameter of 50"
- Powerful Inflation System

Price Does Not
Include Tires or
Rims as Shown

INCLUDES
On-Site Factory
Authorized Training

Lift Gate Service
SKU 290017
HOFLIFTGATE **95⁰⁰**

Warranty
5 year transmission
3 year motor 1 year standard parts
6 months labor



monty® 1625 2 Speed Changer

SKU 312540 HOFEEWH748A **6,099⁹⁹**

- 14 RPM 2 Speed Motor Allows for Quicker Turnaround Times
- Designed for High-Volume Tire Shops, Multi-Bay Repair Shops and Car Dealerships
- Outer Wheel Clamping Diameter: 10" - 24"
- Inner Wheel Clamping Diameter: 12" - 26"
- Maximum Tire Diameter: 50"

INCLUDES
On-Site Factory
Authorized Training

Lift Gate Service
SKU 290017
HOFLIFTGATE **95⁰⁰**

Warranty
5 year transmission
3 year motor 1 year standard parts
6 months labor

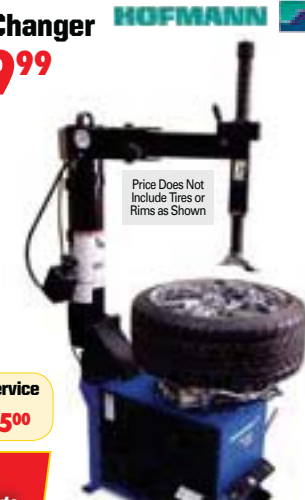

Price Does Not
Include Tires or
Rims as Shown

monty® 8100s Center Post Tire Changer

SKU 298106 HOFEEWH768C **8,499⁹⁹**

- monty 8100S Center Post Tire Changer Designed for Easy Use with Minimal Training of Technicians Reducing Shop Overhead and Adding to Your Bottom Line

Price Does Not
Include Tires or
Rims as Shown

INCLUDES
On-Site Factory
Authorized Training

Lift Gate Service
SKU 290017
HOFLIFTGATE **95⁰⁰**

Warranty
5 year transmission
3 year motor 1 year standard parts
6 months labor

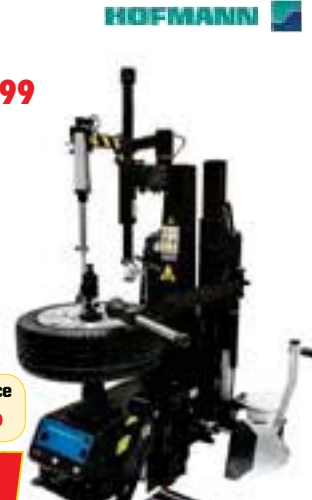

TIRE SERVICE

Leasing Terms Available!†

Ask Your AutoZone®
Commercial Sales Manager

Tire Changers

COATS

RC-45E Rim Clamp® Tire Changer

SKU 688225 (Electric) **3,999⁹⁹**
AMM8560994901

- External Rim Clamping Range: 6" - 24"
- Maximum Rim Width: 10.5"
- Maximum Tire Diameter: 50"
- Includes Bead Sealing Jet to Aid Inflation



INCLUDES
Manufacturer's
Set-Up and Training

Lift Gate Service
SKU 262529
AMMLIFTGATE **55⁰⁰**

COATS

RC-55E Rim Clamp® Tire Changer

SKU 688223 **5,199⁹⁹**
AMM8560995001

- Robo-Arm® Power Assist for Low-Profile and Run-Flat Tires
- External Rim Clamping Range from 6" - 24" Diameter
- Maximum Rim Width 10.5"
- Maximum Tire Diameter 50"
- Electric Turntable



INCLUDES
Manufacturer's
Set-Up and Training

Lift Gate Service
SKU 262529
AMMLIFTGATE **55⁰⁰**

Price Does Not
Include Tires or
Rims as Shown

60X Rim Clamp® Tire Changer

SKU 298103
AMM80060XE1

6,799⁹⁹

- Rim Diameter: 6 - 24" External
- Patented Robo-Arm® Helper Device
- Hand Activated Bead Loosener
- Single Point Sealer



COATS

Price Does Not
Include Tires or
Rims as Shown

INCLUDES
Manufacturer's
Set-Up and Training

Lift Gate Service
SKU 262529
AMMLIFTGATE **55⁰⁰**

GTS-70 Tilt-Back Tire Changer

SKU 019305 **7,899⁹⁹**
AMM85610076

- External Rim Diameter: 6 - 24"
- Rim Width 15"
- Powered Roller Disk Multiple Uses Include: Bead Loosening, TPMS Access, Bottom Bead Removal and Top Bead Mounting
- Electric Drive System 1HP Electric Motor, 110VAC



COATS

INCLUDES
Manufacturer's
Set-Up and Training

Lift Gate Service
SKU 262529
AMMLIFTGATE **55⁰⁰**

Price Does Not
Include Tires or
Rims as Shown

70X, Electric, Hand, Premium Accessory Kit

SKU 979908 **7,899⁹⁹**
AMM80070XE3

- Rim Diameter: 6 - 24" External
- Patented Robo-Arm® Helper Device
- Hand Activated Bead Loosener
- Single Point Sealer



COATS

Grip Max® Plus Adjustable Clamps

SKU 012699 **599⁹⁹**
AMM85607986

- 16" - 28" External Clamping
- Updated Jaw Profile Accommodates Newer Rim Flange Profiles
- Wider Grip Contact Area and New Material Further Reduce Slip on Polished Surfaces

INCLUDES
Manufacturer's
Set-Up and Training

Lift Gate Service
SKU 262529
AMMLIFTGATE **55⁰⁰**

ENTRY LEVEL TIRE CHANGERS

User Setup Required. Factory Authorized
Service Network Available.

BASELINE

BL300 Tire Changer with 24" External Clamping Capacity

SKU 510997 **2,099⁹⁹**
AMM85002300

- Drive System: Electric
- Rim Width: 10" Maximum
- Includes Bead Sealing Jets to Aid in Inflation
- Wheel Clamping Capacity: 10" - 24" External, 12" - 26" Internal



**Comes with 1 Year
Parts Warranty**

Lift Gate Service
SKU 262529
AMMLIFTGATE **55⁰⁰**

BL500 Tire Changer with 24" External Clamping and Robo-Arm®

SKU 509828 **2,799⁹⁹**
AMM85002500

- Drive System: Electric
- Rim Width: 10" Maximum
- Includes Bead Sealing Jets to Aid in Inflation
- Wheel Clamping Capacity: 10" - 24" External, 12" - 26" Internal
- Fully Articulating Robo-Arm Helper to Aid in Mounting Stiffer Sidewall Tires



**Comes with 1 Year
Parts Warranty**

Lift Gate Service
SKU 262529
AMMLIFTGATE **55⁰⁰**

BASELINE

Mount/Demount Heads

Fits On Models

Fits On Models

Red Nylon Mount/ Demount Head

SKU 459185 **39⁹⁹**
TMRTC343



Hunter
Accuturn
Ranger
TC250, TC300, TC325, TC350, TC2000, TC3250, TC3500, TC3000 and TC3100 Series (Require Adapter) 220A. All Other Models Require 102765 Adapter R980X Rev A Models, R980XR/NXT, R30XLT, RX-850/950-B Models, R23/23ST, R26ST/26EX, R745 and R710 Models ONLY. Require RAN5150524 Adapter

Coats Nylon Mount/Demount Head - Tapered Hole

SKU 459189 **69⁹⁹**
TMRTC450310



All Tool
Coats
Corgi
Giuliano
Hofmann
Hunter
Sice
All Models
RC1, 5, 10, 15, 20, Early 5060, 9010, 9024 and APX90
All Rim Clamp
Shaft Needs to Be Turned 180 Degrees for This
Head to Work
Earlier Models Except 1550, 1620 and 1625
Fits All TCX Series (Earlier TCX500 Requires Upgrade
Shaft and Kit RP11-8-114-00091)
M39, S40, S41, S42, S43, S45, S408MAXI, S435, S436
and S436TOP

Coats Nylon Mount/ Demount Head - Tapered Hole

SKU 459183 **39⁹⁹**
TMRTC183061



Coats
Baseline
5030, 5035, 5040, 5045, 5050, 5060, 5065, 6050, 6060, 7050, 7055, 7060, 7065, 7655, 7660 and 7665
BL200, BL300, BL400 and BL500

Coats Nylon Mount/Demount Head - Tapered Hole

SKU 459174 **69⁹⁹**
TMRTC20024335



Accuturn
Hofmann
John Bean
Snap On
3602, 3602HP, 4260, 4560MR, 4602, 5602 and 5602 HP
1520, 1565, 1620, 1625EM, 3300, 3300EM, 1270, 2300, 3000 and 3000GP
EHP System IVE, IV, III, IIE
All Models

Low Profile Mount/Demount Head

SKU 557259 **44⁹⁹**
TMRTC184432



Coats
5030, 5040, 5050, 5060, 5065, 6050, 6060, 6065, 7050, 7055, 7060, 7065, 7655, 7660 and 7665, BL200, BL300, BL400 and BL500

Nylon Mount/Demount Head Kit with Round Hole

SKU 459195 **99⁹⁹**
TMRTC14024784



Accuturn
Hofmann
John Bean
Snap On
3602, 3602HP, 4260, 4560MR, 4602, 5602 and 5602 HP
1520, 1565, 1620, 1625EM, 3300, 3300EM, 1270, 2300, 3000 and 3000GP
EHP System IVE, IV, III, IIE
All Models

Mounting Flange for Demount Head (Flange Only)*

SKU 899502 **54⁹⁹**
RAN5150524



Ranger
Products

Nylon Mount/Demount Head Kit with Round Hole

SKU 459187 **99⁹⁹**
TMRTC250309



All Tool
Coats
Corgi
Hofmann
Sice
All Models
RC1, 5, 10, 15, 20, Early 5060, 9010, 9024 and APX90
All Rim Clamp
Earlier Models Except 1550, 1620 and 1625
M39, S40, S42, S43, S45, S408MAXI, S435, S436
and S436TC

Free Delivery!
in 48 Continental United States

Specifications Subject to Change without Notice or Liability. Customers Responsible for Off-Loading Equipment Upon Arrival.

Leasing Terms Available.†
Ask Your AutoZone® Commercial Sales Manager.

**Delivery Included
on Tire Changers
and Wheel Balancers**



1-877-AZTool1 (1-877-298-6651) Hablamos Español

AutoZone
Tool & Equipment QUARTERLY

Wheel Balancers

BaseLine 350 Wheel Balancer

SKU 818787
AMM85002350 **2,099⁹⁹**

- Manual Data Entry
- Foot Pedal Brake for Easy Weight Placement
- Self-Diagnosis and Self-Calibration
- One Button Split and Hidden Weight Program



BASELINE

**Comes with 1 Year
Parts Warranty**

Lift Gate Service
SKU 262529
AMMLIFTGATE **55⁰⁰**

BaseLine 550 Wheel Balancer

SKU 818786
AMM85002550 **2,799⁹⁹**

- Automatic Distance and Diameter Entry (2D)
- Direct Weight Location
- Direct Selection Ounce/Grams



BASELINE

**Comes with 1 Year
Parts Warranty**

Lift Gate Service
SKU 262529
AMMLIFTGATE **55⁰⁰**

BASELINE ENTRY LEVEL WHEEL BALANCER

User Setup Required. Factory Authorized Service Network Available.

**geodyna[®] 7100 Wheel Balancer
with LED Display**

SKU 339018
HOFEWB761AE1 **2,164⁹⁹**

- Combines High Accuracy with Small Footprint
- Semi-Automatic Input of Rim Diameter and Offset with Gauge Arm
- Short Balancing Cycle: 4.5 Seconds
- Rim Diameter: 8" - 32"



HOFMANN

**User Set-Up
Required**

Lift Gate Service
SKU 290017
HOFUFTGATE **95⁰⁰**

Warranty
90 days parts/labor

**Hofmann geodyna[®] 7400L
Wheel Balancing System**

SKU 850652
HOFEWB764AL **4,649⁹⁹**

- Video Display
- Balance Time: 6.5 Seconds
- Automatic Data Entry
- Includes: Ziplock Ring Nut, Spacer Ring, Drum, Drum Cushion and 4 Cone Set



HOFMANN

INCLUDES
On-Site Factory
Authorized Training

INCLUDES
4 Piece Cone Kit
HOFEAK0309J28A **\$134⁶²**
Value

Lift Gate Service
SKU 290017
HOFUFTGATE **95⁰⁰**

Price Does Not
Include Tires or
Rims as Shown

Warranty
5 year motor
3 year electronic circuit board
1 year standard parts
6 months labor

Hofmann geodyna[®] 7600L

SKU 298104
HOFEWB765AL **5,724⁹⁹**

- Touchscreen and Video Display with 2D SAPE Data Entry
- Smart Sonar for Non-Contact Rim Width Acquisition
- EasyWeight Pinpoint Laser and Rim Lighting for Speed, Accuracy and Efficiency on Every Balancing Job



HOFMANN

INCLUDES
On-Site Factory
Authorized Training

INCLUDES
4 Piece Cone Kit
HOFEAK0309J28A **\$134⁶²**
Value

Price Does Not
Include Tires or
Rims as Shown

Lift Gate Service
SKU 290017
HOFUFTGATE **95⁰⁰**

Warranty
5 year motor
3 year electronic circuit board
1 year standard parts
6 months labor

**Hofmann geodyna[®]
7600P with Laser and
Power Clamp**

SKU 327605
HOFEWB765AP **6,499⁹⁹**

- Wheel Balancer Features the Power Clamp Electromechanical Clamping System
- Smart Sonar for Non-Contact Rim Width Acquisition



HOFMANN

INCLUDES
On-Site Factory
Authorized Training

INCLUDES
4 Piece Cone Kit
HOFEAK0309J28A **\$134⁶²**
Value

Lift Gate Service
SKU 290017
HOFUFTGATE **95⁰⁰**

Price Does Not
Include Tires or
Rims as Shown

Warranty
5 year motor
3 year electronic circuit board
1 year standard parts
6 months labor

TOP SELLER

Digital Wheel Balancer

SKU 977528
RANDST2420 **1,764⁹⁹**

- Motor: 3/4 HP, 110V/220V, 50/60 Hz, 1 Phase
- Balancing Modes: Dynamic/Static/3 Alloy
- Cycle Time: 6 to 9 Seconds
- Self-Calibrating
- Max. Tire Diameter: 47" (1,194 mm)
- Max. Tire Weight: 145 Lbs.
- Balancing Speed: 180 RPM
- Balance Increments: 0.25 or 0.01 Oz.
- Accuracy: +/- 1 Gram/.035 Oz.



Ranger

Price Does Not
Include Tires or
Rims as Shown

Lift Gate Service
SKU 262533
RANLIFTGATE **135⁰⁰**

COMES WITH:
Wheel Weight Starter Kit #5150235
Includes: 100 piece
silver roll and 100 piece
black roll **\$74³⁸**
Value

Digital Wheel Balancer

SKU 343398
RANDST-64T **2,599⁹⁹**

- Ergonomic Control Board with Soft Touch Keys and Easy-to-Read LED
- Motor: 1.5 HP, 208 - 230V, 50/60 Hz, 1 Phase
- Maximum Tire Diameter: 50"
- Maximum Tire Weight: 150 Lbs.
- Cycle Time: 6 - 12 Seconds (Avg.) Depending on Wheel
- Precision-Machined, Hardened-Steel 36 mm Shaft



Ranger

Price Does Not
Include Tires or
Rims as Shown

Lift Gate Service
SKU 262533
RANLIFTGATE **135⁰⁰**

COMES WITH:
Wheel Weight Starter Kit #5150235
Includes: 100 piece
silver roll and 100 piece
black roll **\$74³⁸**
Value

DON'T FORGET THIS ACCESSORY

• Works with Ranger Wheel Balancers Listed on This Page



Truck Cone Kit
SKU 902536 RANRWS-ITC-1 **249⁹⁹**

1300 2D Wheel Balancer

SKU 592250
AMM80013002D **4,669⁹⁹**

- Auto Distance and Diameter Data Entry
- Behind the Spoke Mode
- 40 mm Shaft Diameter
- Maximum Tire Diameter: 44"
- 220V, 1 Phase



COATS

Price Does Not
Include Tires or
Rims as Shown

Lift Gate Service
SKU 262529
AMMLIFTGATE **55⁰⁰**

INCLUDES
Manufacturer's
Set-Up and Training

NEW

1500A 3D Wheel Balancer

SKU 339012
AMM80015003D **6,799⁹⁹**

- Powered by Direct Drive
- Includes Premium Quick Nut
- Automatic 3-D Data Entry
- Basic Adapter Kit Included
- NEW Collet Adapters



COATS

Price Does Not
Include Tires or
Rims as Shown

Lift Gate Service
SKU 262529
AMMLIFTGATE **55⁰⁰**

INCLUDES
Manufacturer's
Set-Up and Training

1600A 3D Wheel Balancer

SKU OUTSIDE BUY/EPO
AMM80016003D **8,499⁹⁹**

- Powered by Direct Drive
- ProBalance Technology™
- Premium Quicknut
- Stop, Lock and Index
- 8 Balancing Modes
- Automatic 3-D Data Entry
- Basic Adapter Kit Included



COATS

Price Does Not
Include Tires or
Rims as Shown

Lift Gate Service
SKU 262529
AMMLIFTGATE **55⁰⁰**

INCLUDES
Manufacturer's
Set-Up and Training

**Available via
Outside Buy/EPO.**
Call 1-877-298-6651 for
ordering instructions.

DON'T FORGET THESE ACCESSORIES

• Works with Coats Wheel Balancers Listed on This Page



Adjustable Pin Plate Set
SKU 818762 AMM85610104 **1,499⁹⁹**



40 mm Light Truck Cone
SKU 212844 AMM8113277C **289⁹⁹**

Free Delivery!
in 48 Continental United States

Specifications Subject to Change without Notice or Liability.
Prices Do Not Include Vehicles, Installation or Optional Equipment as Shown.

Customers Responsible for Off-Loading Equipment Upon Arrival.
Ask Your Sales Rep for Details.

Leasing Terms Available.*
Ask Your AutoZone® Commercial Sales Manager.

TIRE SERVICE

ATEQ TPMS Tools and Readers

VT36 TPMS PROGRAMMING TOOL

SKU 596887
ATEVT36-0000 **289⁹⁹**

- Programs All Leading Aftermarket Programmable Sensors
- Reads and Activates TPMS Sensors
- Displays TPMS Sensor Data (ID, Tire Pressure, Tire Temperature, Battery Status, Frequency)
- Make, Model and Year Specific Relearn Procedures

ATEQ



VT55 OBDII TPMS Diagnostic Tool

SKU 095059 **999⁹⁹** REG. \$1,249.99

SAVE \$250

- 3 Year Free Software Updates Included
- 98% Coverage on Vehicles Equipped with TPMS
- Comprehensive MMY Specific Re-Learn Procedures
- Programs and Decodes Programmable and Universal TPMS Sensors
- OBDII Programming on Applicable Asian European and Domestic Vehicles



Offer Good Through June 30, 2017 While Supplies Last

Diagnostic TPMS Tool

SKU 544586 **1,399⁹⁹** REG. \$1,699.99

SAVE \$300

- 98% Coverage on Vehicles Equipped with TPMS
- Selects MMY via VIN Scan
- Comprehensive MMY Specific Re-Learn Procedures
- Programs and Decodes Programmable and Universal TPMS Sensors
- Built-In Training Procedures



Offer Good Through June 30, 2017 While Supplies Last

Tire Taxi



- Designed to Transport Car, Light Truck and SUV Tires and Wheels
- Efficiently Transport Tires from Storage Areas to Service Bays
- May be Used for Display Purposes
- (4) Heavy-Duty 3" Casters (One Locking Caster Included) Allow Effortless Movement and 360 Degree Rotation
- Capacity: (5) Tire and Wheel Assemblies or (8) Tires (265 Lbs.)

Tire Taxi
SKU 597221 **109⁹⁹**
DOWJDITT1



Tire Taxi Extended
SKU 597206 **219⁹⁹**
DOWJDITTIEX

NEW



Tire Inflator

SAVE \$10

OEM TOOLS

Digital Tire Inflator

SKU 802198 **49⁹⁹** REG. \$59.99

- Easy-to-Read Backlit LCD Display
- Four Units of Measure (PSI, Bar, KPa, kgf)
- Measuring Range: 0 - 175 PSI (0 - 12 Bar)
- Accuracy: +/-1.2 PSI Up to 58 PSI, +/-2.3 Between 58 PSI and 145 PSI Inclusive, +/-3.6 PSI Greater Than 145 PSI
- High Air Flow Saves the Technician Time



Offer Good Through June 30, 2017 - While Supplies Last

Autel TPMS Tools

READS / WRITES SENSOR IDS

MaxiTPMS® TS501K Diagnostic and Service Tool with 8 TPMS Sensors (Sensors \$319.00 Value)

SKU 850650 **549⁹⁹**
AULTS501K

- Activates Sensors Using 125KHz Continuous or Modulated Wave Signals
- Programs Vehicle ECU to Learn Sensor IDs and Positions
- Capable of Programming Single Tires
- Reads/Clears Codes of TPM System
- Reset TPMS Malfunction Light
- Display Replacement Part Number
- Includes 2 Rubber Stem Sensors and 6 Metal Stem Sensors
- Replaces 98% of OE Sensors on the Market

BETTER



SHOWS TPMS LIVE DATA

MaxiTPMS® TS601 All-In-One TPMS Tool with OBDII

SKU 376934 **959⁹⁹**
AULTS601P

- OBDII Reads, Records, and Plays Back Complete OBDII Vehicle Stream
- TPMS Live Data Including Tire Pressure, Signal Status, Temperature, and Battery Status
- Programs Vehicle ECU to Learn Sensor IDs and Positions

BEST



315MHz / 433MHz Universal Programmable MX-Sensors

- Built to Perform Like OE Sensors in Terms of Signal, Durability and Functionality
- Robust Clamp-In Pivoting Stem Design Allows for 0-35 Degree Angle Adjustment to Fit All Wheel Types
- 2 SKU Sensor Solution Covers 98% of All OE Sensors

Metal Tip Sensors

SKU 080038 **315MHz 39⁹⁹**
AULMXSENS315M

SKU 080039 **433MHz 39⁹⁹**
AULMXSENS433M

Rubber Sensors

SKU 290274 **315MHz 31⁹⁹**
AULMXSENS315R

SKU 290286 **433MHz 33⁹⁹**
AULMXSENS433R



MaxiTPMS® Pads

SKU 526852 **69⁹⁹**
AUL101000017

- No Need for Vehicle Relearns
- Ideal for Mechanically Broken Sensors
- Automatically Creates ID Numbers Compatible with the Vehicle
- Runs from PC USB Power, No Batteries Required



	AULTS501K	AULTS601P
Activate Sensors and Retrieve Data	Yes	Yes
Display Relearn Procedures	Yes	Yes
Step-by-Step Graphic Direction for OE Relearn Procedures	Yes	Yes
Autel MX Sensor Programming Capabilities	Yes	Yes
OBDII Interface to Extract TPMS Codes	Yes	Yes
Detect and Display TPMS System Faults	Yes	Yes
Read and Clear TPMS Information	Yes	Yes
Complete TPMS System Diagnostics	No	Yes
Live TPMS Data Stream	No	Yes
Adjust Tire Size Placard Values	No	Yes
Receives Both 315Mhz and 433Mhz Sensors	Yes	Yes
Includes 6 Metal Stem and 2 Rubber Stem Sensors	Yes	No



TS401
128x64 B/W Backlit Display



TS501 / TS601
320x240 TFT Color Display



Tool Resistant
Grease & Water



Li-Polymer
3.7V Built In Rechargeable



Auto Power Off
Battery Life Conservation



INCLUDED
4GB Class 4 SD Memory Card



Receives Both Sensors
315MHz 433MHz

DID YOU KNOW?

AutoZone® can get Stoptech brand high performance brake systems.

Contact Your AutoZone Commercial Sales Manager for Details

Solutions for better vehicle service!



TECH 400 PRO TPMS Scan Tool

SKU 760944
WRT400PRO

\$1,699⁹⁵

Made in the U.K.!



Assembled in the U.S.A.!

- ☑ Easy to Operate
- ☑ More OBD Relearns
- ☑ More Fault Code Detection
- ☑ Wireless Updating
- ☑ TPMS Placard Adjusting
- ☑ Wireless Inductive Charging
- ☑ Passive Key System testing
- ☑ TIA Inside Technology

THREE TIME WINNER IN 2016



TPG 100 Bluetooth Tread and Pressure Gauge

\$59⁹⁹

SKU 536280
WRTTPG100

- ☑ Measures Pressure and Tread Depth
- ☑ Sends data via Bluetooth
- ☑ Works on passenger car and light truck applications
- ☑ C.A.R.B. compliant accuracy of ±2 PSI
- ☑ Measures tread depth within ±2mm [.078"]
- ☑ Easy to read, in daylight and low light conditions
- ☑ Has an LED flashlight
- ☑ Down load free smart phone application



Contact Us:
1-877-AZTool1 Phone
 (1-877-298-6651) *Hablamos Español*

AutoZone® Tool & Equipment QUARTERLY

Wheel Weights



Complete Wheel Weight Program Available!

Call 1-877-AZTool1 or go to AZTool1.com for More Styles and Information.

Steel Wheel Weights

AZ SKU NUMBER	PART NUMBER	STYLE	QUANTITY	PRICE
382853	AMM025PFEPK4	PFE, 0.25 Oz.	4 Boxes of 25	23.99
382919	AMM050PFEPK4	PFE, 0.50 Oz.	4 Boxes of 25	24.99
382920	AMM075PFEPK4	PFE, 0.75 Oz.	4 Boxes of 25	28.99
382921	AMM100PFEPK3	PFE, 1.00 Oz.	3 Boxes of 25	27.99
382922	AMM125PFEPK3	PFE, 1.25 Oz.	3 Boxes of 25	31.99
382923	AMM150PFEPK3	PFE, 1.50 Oz.	3 Boxes of 25	34.99
382924	AMM175PFEPK3	PFE, 1.75 Oz.	3 Boxes of 25	37.99
382925	AMM200PFEPK3	PFE, 2.00 Oz.	3 Boxes of 25	39.99
382926	AMM225PFEPK2	PFE, 2.25 Oz.	2 Boxes of 25	29.99
382927	AMM250PFEPK2	PFE, 2.50 Oz.	2 Boxes of 25	31.99
382928	AMM275PFEPK2	PFE, 2.75 Oz.	2 Boxes of 25	32.99
382841	AMM025MCFEPK4	MCFE, 0.25 Oz.	4 Boxes of 25	30.99
382842	AMM050MCFEPK4	MCFE, 0.50 Oz.	4 Boxes of 25	34.99
382843	AMM075MCFEPK4	MCFE, 0.75 Oz.	4 Boxes of 25	38.99
382844	AMM100MCFEPK3	MCFE, 1.00 Oz.	3 Boxes of 25	33.99
382845	AMM125MCFEPK3	MCFE, 1.25 Oz.	3 Boxes of 25	38.99
382846	AMM150MCFEPK2	MCFE, 1.50 Oz.	2 Boxes of 25	30.99
383004	AMM025TFEPK4	TFE, 0.25 Oz.	4 Boxes of 25	30.99
383005	AMM050TFEPK3	TFE, 0.50 Oz.	3 Boxes of 25	27.99
383021	AMM025ALFEPK4	ALFE, 0.25 Oz.	4 Boxes of 25	30.99
383022	AMM050ALFEPK4	ALFE, 0.50 Oz.	4 Boxes of 25	34.99
383129	AMM25LHFEK3	LHFE, 0.25 Oz.	3 Boxes of 25	25.99
383130	AMM50LHFEK3	LHFE, 0.50 Oz.	3 Boxes of 25	27.99
383038	AMM10GFNFEK3	FNFE, 10g	3 Boxes of 25	28.99
383039	AMM15GFNFEK3	FNFE, 15g	3 Boxes of 25	30.99
383107	AMM10GENFEK4	ENFE, 10g	4 Boxes of 25	34.99
383108	AMM15GENFEK4	ENFE, 15g	4 Boxes of 25	37.99
383118	AMM10GIWFEPK4	IWFE, 10g	4 Boxes of 25	34.99
383119	AMM15GIWFEPK3	IWFE, 15g	3 Boxes of 25	30.99

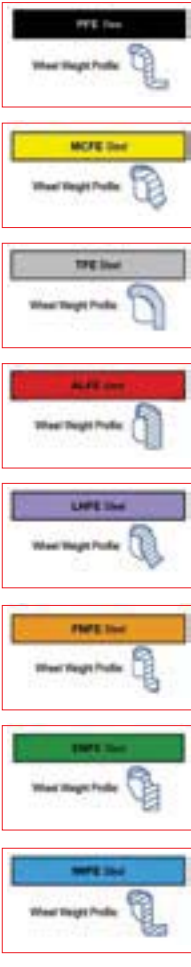

Introducing Lead Wheel Weights*

BADA's Thinline Style Un-Coated Wheel Weights are Designed for Steel Wheels on All Import and Domestic Passenger Cars, 1/2 Ton Trucks and All Mini Pickups and Vans with Standard .125" Flange

AZ SKU NUMBER	PART NUMBER	SIZE (OUNCES)	QUANTITY	PRICE
752047	AMM5522025PK4	0.25	4 Boxes of 50	26.99
752041	AMM5522050PK4	0.50	4 Boxes of 50	33.99
752042	AMM5522075PK4	0.75	4 Boxes of 50	45.99
752043	AMM5522100PK3	1.00	3 Boxes of 50	40.99
752044	AMM5522125PK3	1.25	3 Boxes of 50	50.99
752045	AMM5522150PK2	1.50	2 Boxes of 50	39.99
752046	AMM5522175PK2	1.75	2 Boxes of 50	49.99
752048	AMM5522100200	2.00	1 Box of 50	29.99
752051	AMM5522100225	2.25	1 Box of 50	34.99
752053	AMM5522100250	2.50	1 Box of 50	36.99
752065	AMM5522100275	2.75	1 Box of 50	36.99
752066	AMM5522100300	3.00	1 Box of 50	41.99



Applications: Import and Domestic Cars and Light-Trucks with Steel Wheels
 *Due to environmental laws we are prohibited from supplying lead wheel weights to certain states. If you are ordering lead wheel weights from one of the following states your order will not be processed: California, Maine, Vermont, New York, Virginia, Washington, Minnesota, Illinois, Iowa, Maryland, Rhode Island, Kentucky, Wisconsin and West Virginia. We do offer steel wheel weights as a suitable alternative to lead wheel weights.

Tape-A-Weight® Steel Wheel Weight

AZ SKU NUMBER	PART NUMBER	SIZE (OUNCES)	QUANTITY	PRICE
019312	AMM5533601025	0.25	10 Lbs. Roll	54.99
019310	AMM5533701050	0.50	10 Lbs. Roll	54.99
019304	AMM5533600300	0.25	25 Strips - 40 Segments Each	44.99
019294	AMM5533700500	0.50	24 Strips - 10 Segments Each	54.99
019301	AMM5533800700	1.00	16 Strips - 7 Segments Each	54.99



Tape-A-Weight® Roll Dispenser

SKU 019292 **149.99**
 AMM5310025 Stand only, Weights Not Included

Steel Weight Starter Kits

Metal Floor Rack with 1,700 Steel Weight Assortment

SKU 383179 **799.99**
 AMM5202075
 • Steel Rack, Application Chart, Header Card, Channel Cards, Rim Gauge, Premium Wheel Weight Hammer, Tape-A-Weight Scraper, 8 Styles of Wheel Weights: MCFE, ALFE, PFE, TFE, IWFE, FNFE, LHFE and INFE

Weight Replenishment Kit For 5202075 Steel

SKU 383180 **499.99**
 AMM5202080

Bench Top Rack with 1,000 Coated Steel Weight Assortment

SKU 383181 **599.99**
 AMM5202125
 • Louvered Rack Can Be Placed on Top of Any Work Bench
 • Includes: Steel Rack, Application Guide, Header Card, Bin Labels, Rim Gauge, Wheel Weight Hammer, (5) Style Wheel Weights: PFE, ALFE, MCFE, TFE, FNFE, (40) Plastic Bins: (8) of Each: Yellow, Gray, Black, Red and Orange

Weight Replenishment Kit For 5202125 Steel

SKU 382825 **349.99**
 AMM5202130



Tire Service Tools

Air Tire Buffer
 SKU 802218 **79.99**
 24410 REG. \$89.99
 • Recommended Air Pressure: 90 PSI
 • Air Consumption: 3.5 CFM
 • Free Speed: 2,600 RPM
 • Air Inlet Thread Size: 1/4" NPT
 • Minimum Hose Size: 3/8"

2 Piece Valve Core Tool Set
 SKU 255622 **14.99**
 VCTSET
 • For Inserting or Removing Valve Cores
 • Ergonomic Shaped Handles That Provide Firm Grip
 • Includes 2" and 4" Tools

4 Piece, Deep Thin Wall, SAE and Metric Impact Flip Socket Set
 SKU 965857 **24.99**
 24223
 • Includes 3/4" - 13/16", 19 mm - 21 mm and 7/8" - 15/16" Sockets and 3" Extension

8 Piece Wheel Stud Alignment Guide Kit
 SKU 818715 **29.99**
 24233 REG. \$34.99
 • Makes the Job Faster and Easier Allowing the Tech to Safely Position the Wheel Prior to Installing the Wheel Bolts
 • Application: Mercedes, BMW, Audi, VW, Porsche, Fiat and Dodge
 • Sizes Included: 12 mm x 1.5, 12 mm x 1.25, 14 mm x 1.25 and 14 mm x 1.75

9 Piece Wheel Lock Removal Impact Socket Set
 SKU 965865 **49.99**
 24225
 • Includes: GM Hubcap Lock Remover, GM Sprocket Hubcap Remover, Ford and Chrysler Hubcap Lock Remover, Large Universal Locking Lug Nut Remover, Large Wheel Cover Lock Remover, Remover for Stripped 18 mm Lug Nuts, GM "M" and "F" Body

5 Piece Torque Limiting Extension Set
 SKU 965858 **99.99**
 24220
 • Quick, Simple and Accurate
 • Helps Prevent Lug Stud/Nut Damage and Warped Rotors
 • Includes 1/2" Drive Extensions: 65 Ft./Lbs., 80 Ft./Lbs., 100 Ft./Lbs., 120 Ft./Lbs. and 140 Ft./Lbs.

8 Piece Torque Limiting Extension and Thin Wall Socket Set
 SKU 347217 **79.99**
 24228 REG. \$99.99
 • (4) Extension Bars: 65 Ft./Lbs. (90 Nm), 90 Ft./Lbs. (120 Nm), 100 Ft./Lbs. (135 Nm) and 110 Ft./Lbs. (150 Nm)
 • (4) Deep Sockets: 17, 19, 21 and 22 mm

5 Gallon Bead Seater
 SKU 526505 **199.99**
 24449
 • Seats Beads on All Tires, from Small 4" Tires to 24-1/2" Truck Tires
 • Operates on Standard Shop Air; Max. 120 PSI
 • Lip on Barrel Allows for Proper Angle for Correct Bead Seating

Truck Wheel Stud Installer

SKU 339117 **19.99**
 24235
 • Designed to Work on Truck Wheel Studs Up to 22 mm (7/8") in Diameter
 • Use with an Impact Wrench or Ratchet

Wheel Stud Installer Set for Cars and Trucks
 SKU 339125 **29.99**
 24236

OEM TOOLS

Wheel Stud Installer
 SKU 339123 **19.99**
 24234
 • Works with Hubs, Rotors and Axles on Both Front and Rear Wheel Drive Vehicles
 • Prevents Damage to Lug Nut or New Stud
 • Designed to Fit Studs Up to 14 mm or 9/16"

Wheel Weight Hammer Tool
 SKU 217378 **22.99**
 25690
 • Tool Installs, Removes, Trims and Tightens All Types of Clip-On Wheel Weights
 • Features a Special Plastic Material on Hammer Head for Safe, Mar-Free Installation of Specially Coated Wheel Weights Used on Alloy Wheels

3 Piece, Extra Thin Wall, Wheel/Nut Protector Impact Socket Set
 SKU 094646 **24.99**
 25583
 • 17 mm / 11/16" - Blue
 • 19 mm / 3/4" - Yellow
 • 21 mm / 13/16" - Red

3 Piece Super Strength Wheel Nut Impact Socket Set
 SKU 347212 **49.99**
 24227
 • Color Coded for Easy Size Identification
 Blue - 17 mm, Gold - 19 mm and Red - 21 mm

9 Piece, Thin Wall, Wheel Protector Impact Socket Set
 SKU 965856 **79.99**
 24224
 • Hard Plastic Sleeve and Insert Protects Expensive Wheels and Lug Nuts from Damage
 • Sizes: 3/4", 7/8", 13/16", 15/16", 1", 1-1/16", 17 mm, 19 mm and 21 mm

16 Piece Locking Lug Master Key Set
 SKU 626107 **99.99**
 24447
 • Easily Removes Locking Lug Nuts on Most Aftermarket Wheels
 • Thin Wall Sockets Prevent Damaging Wheels and Lugs
 • Double Hex-Head Design Fits Most Lug Wrenches as Well as 13/16" and 7/8" Sockets
 • Chart Included
 • Comes in a Blow Mold Case

10 Piece Torque Limiting Socket Set (1/2" Drive)
 SKU 965855 **199.99**
 24221
 • Prevents Under and Over Torquing
 • Includes: 17 mm x 55 Ft./Lbs. 17 mm x 80 Ft./Lbs. 21 mm x 80 Ft./Lbs. 19 mm - 3/4" x 100 Ft./Lbs. 19 mm - 3/4" x 65 Ft./Lbs. 19 mm - 3/4" x 80 Ft./Lbs. 22 mm - 7/8" x 120 Ft./Lbs. 22 mm - 7/8" x 140 Ft./Lbs.

Spare Tire Removal Tool Kit
 SKU 479984 **144.99**
 THX497X
 • Kit Includes a Hand Crank and (6) Different Zinc Plated Steel Tools to Fit Most Pick-Ups, Vans and SUV-Type Vehicles

Tire Tube Test Tank
 SKU 291382 **69.99**
 LIS19822
 • Tank Features Reinforcement Ribs for Extra Support
 • Will Handle Passenger Tire Sizes to Wide Oval and Light Duty Truck Tires
 • Dimensions: 31" (L) 12" (W) 12" (H)

AUTOMOTIVE LIFTS

2 Post Lifts

Challenger E10 10,000 Lbs. 2 Post Lift

SKU 435061
CHLLE10 **2,799⁹⁹**

- 3-Stage Front Arms and 2-Stage Rear Arms for Asymmetric or Symmetric Lifting in the Same Service Bay, Uni-Body Design Vehicles, Vehicles with Designated Outside Lift Points, Wider Vehicles, Low Profile Vehicles and Both Short and Long Wheelbases
- Double Telescoping Screw Pads with Rubber Foot Pads
- Rubber Door Guards Protect Vehicle from Door Damage
- 11' 11-7/8" Standard Height Fits in Service Bay with 12' Ceiling Height



Price Does Not Include Vehicles, Installation or Optional Equipment as Shown

Truck Adapters Included

10,000 Lbs. Dual Width Clearfloor 2 Post Lift, Screw Pad

- Expandable Top Beam Accommodates Wide or Narrow Drive-Thru Configuration
- Double Telescoping Screw Pads Offer Increased Versatility
- Overall Height: 145"

Price Does Not Include Vehicles, Installation or Optional Equipment as Shown

(Truck Adapters Included)

Symmetric

SKU 296968
BENXPR-10S **3,149⁹⁹**

- Inside Columns: 105.5" - 118.5"

Asymmetric

SKU 297001
BENXPR-10AS **3,199⁹⁹**

- Inside Columns: 104" - 112"



Symmetric Low-Pro Arms

SKU 296983
BENXPR-10S-LP **3,199⁹⁹**

- Inside Columns: 105-1/2" - 118-1/2"

Asymmetric Low-Pro Arms

SKU 297003
BENXPR-10ASLP **3,199⁹⁹**

- Inside Columns: 104" - 112"



5-2-1 Warranty
Five Years (60 Months) Warranty on the lift structure
Two Years (24 Months) Warranty on the hydraulic cylinder(s) and power unit
One Year (12 Months) Warranty on operating components
One Year (12 Months) Labor Warranty on site or at factory
One Year (12 Months) Free-Shipping* on ground-freight charges related to warranty performance

*Free shipping applies to direct shipping points within the 48 continental United States. Rural area shipping surcharge may apply for remote addresses. See BendPak.com for specific terms of warranty.

10,000 Lbs. 2 Post Lift

SKU 298485
CHLCL10V3 **3,999⁹⁹**

Versymmetric 3 Stage Arms

- Column Height: 11' 8"
- Adjustable Width Overall: 11' 6-1/2" / 11' 11"
- Floor to Overhead Switch: 134-1/2"
- Ceiling Height Required: 12'
- Drive-Thru Clearance: 100" / 104-1/2"

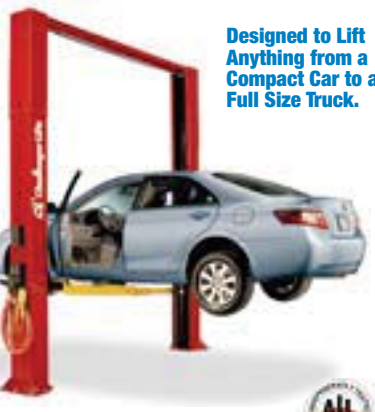

Price Does Not Include Vehicles, Installation or Optional Equipment as Shown

Truck Adapters Included

12,000 Lbs. 2 Post Lift Clearfloor, Triple-Telescope Arms

SKU 296957
BENXPR-12CL **5,199⁹⁹**

- Drop-End Arms Provide a Lower Pad Height
- Triple-Telescoping Front and Rear Arms
- Height Overall: 170"
- Inside Columns: 120"



Price Does Not Include Vehicles, Installation or Optional Equipment as Shown

(Truck Adapters Included)

10,000 Lbs. 2 Post Lift

SKU 499657
FOR110 **2,799⁹⁹**

- Low Profile 3-5/8" Min. Adapter Height
- Spot-Rite™ 3 Stage Front Arms for Symmetric and Asymmetric Lifting
- Overall Height: 143-3/8"
- Overall Floor Width: 137"
- Maximum Lifting Height: 76"
- Inside Column Width: 115"
- Drive-Thru Clearance: 105"
- Minimum Ceiling Height: 144"



(Truck Adapters Included)

Price Does Not Include Vehicles, Installation or Optional Equipment as Shown

10,000 Lbs. F10 2 Post Lift

SKU 818779
FORF10N100MBL **2,599⁹⁹**

- Low Profile/Oversized Pads to Raise Most Vehicles
- 3 Stage Front Arms for Symmetric and Asymmetric Lifting
- Includes (4) 3-1/2" and 5" Adapter Extenders
- Warranty: 60 Days Labor, 18 Months Parts, 5 Years Structural

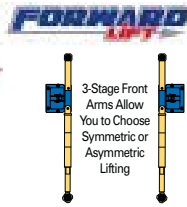

Price Does Not Include Installation or Optional Equipment as Shown

10,000 Lbs. 2 Post Lifts

SKU 534581
ROTSP0A10 **4,089⁹⁹**

Asymmetrical

- Surface Mounted, Frame Contact Lift
- Features Electric Hydraulic Operation and Genuine Symmetrical Design for Overhead Lift
- Factory Rotated Columns Allow Doors of Vehicle to Be Fully Opened While Properly Positioned on Lift
- Arm Restraints on All Arms

Symmetrical

SKU 210371
ROTSP010 **4,089⁹⁹**

We Carry the Full Line of Rotary Lifts!
Call 1-877-AZTool1 for Details.



Price Does Not Include Vehicles, Installation or Optional Equipment as Shown

Challenger CL12, 12,000 Lbs. 2 Post Symmetric Lift

SKU 750127
CHLCL12 **6,299⁹⁹**

- Lifts Heavy Duty PU's to Small Sedans
- 3 Stage Front and 3 Stage Rear Arms Provide Greater Extension and Retraction
- Rise Height: 84-3/4" (2153 mm)
- Ceiling Height Required: 13' 9"



Price Does Not Include Vehicles, Installation or Optional Equipment as Shown

12,000 Lbs. F12N300 2 Post Lift

SKU 818751
FORF12N300BL **4,299⁹⁹**

- 2 Stage Arms Reach: 35" to 54"
- Accommodates Trucks and Many Cars
- Low Profile 4-3/4" Adapters
- Includes Four 3-1/2" and 5" Adapter Extenders
- Warranty: 60 Days Labor, 18 Months Parts, 5 Years Structural

Height Configurations of 11'-10", 12'-10", and 14'-10" are Available



(Truck Adapters Included)

Price Does Not Include Installation or Optional Equipment as Shown

12,000 Lbs. I12N300 2-Post Lift

SKU 818755
FORI12N300BL **5,499⁹⁹**



3 Stage Front and Rear Arms

Brigadier D-10 ACX

SKU 186433
DANI375647 **2,499⁹⁹**

Asymmetric

- Lifting Capacity: 10,000 Lbs. (4,546 Kg)
- Overall Height: 145" (3,683 mm)
- Overall Width (Outside of Base Plates): 143-1/2"
- Width Between Columns: 112-3/4"
- Rise: 69" (1,753 mm)
- Maximum Lifting Height (Pad and 6" Adapter): 79" (2,007 mm)
- Drive-Thru Clearance: 100-1/2"
- Motor: 220 VAC 60Hz. 1Ph



(Truck Adapters Included)

Price Does Not Include Vehicles, Installation or Optional Equipment as Shown

Challenger SA10 10,000 Lbs. 2 Post Vehicle Lift

SKU 847098
CHLSA10 **2,899⁹⁹**

- Can Be Configured in Either the Symmetric or Asymmetric Position
- 3 Stage Front Arms Provide Greater Overall Arm Sweep
- Double Telescoping Screw Pads to Minimize the Need for Adapters



Truck Adapters Included

Symmetrical Column Orientation

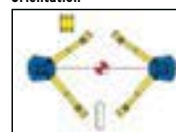

Asymmetrical Column Orientation

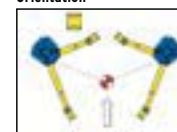

Price Does Not Include Vehicles, Installation or Optional Equipment as Shown

Challenger E12 12,000 Lbs. 2 Post Heavy Duty Lift

SKU 344994
CHLE12 **4,849⁹⁹**

- 2-Stage Telescoping Arms Provide Excellent Reach to Accommodate Vehicle Lifting Points
- 13' 10" or 14' 7" Adjustable Column Height
- Heavy-Duty Telescoping Screw Pads



Price Does Not Include Vehicles, Installation or Optional Equipment as Shown

18,000 Lbs. 2 Post Lift

SKU OUTSIDE BUY/EPO
FORDP18N000BL **11,749⁹⁹**

- Includes Truck Adapter Extensions
- Low Profile Arms
- Overall Height: 154-3/4"
- Overall Width: 154-3/8"
- Rise: 83"



(Truck Adapters Included)

Available via Outside Buy/EPO. Call 1-877-298-6651 for ordering instructions.

Price Does Not Include Vehicles, Installation or Optional Equipment as Shown

Free Delivery! in 48 Continental United States

Specifications Subject to Change without Notice or Liability. Customers Responsible for Off-loading Equipment Upon Arrival.

Leasing Terms Available.† Ask Your AutoZone® Commercial Sales Manager.

Leasing Terms Available!†

Ask Your AutoZone®
Commercial Sales Manager

AutoZone®
Tool & Equipment QUARTERLY

2 Post Floor Plate Lifts

D-9/X 9,000 Lbs. 2 Post Lift

SKU 186430 DAN1375646 **2,699⁹⁹**

- Perfect for Shops and Garages with Height Restrictions
- Truck and Van Adapter Set Included
- Overall Height: 113"



Dannmar
EQUIPMENT

Price Does Not Include Vehicles, Installation or Optional Equipment as Shown

Dual-Width, 9,000 Lbs. 2 Post Lift, Floor Plate

SKU 296950 BENXPR-9DS **2,899⁹⁹**

- Adjustable Width Design Configures for Wide or Narrow Installation
- Direct-Drive Lifting System Eliminates Chains and Pulleys
- Large, 20" x 19" Steel Base Plates
- Overall Height: 145"
- Inside Columns: 105"-118"

(Truck Adapters Included)



BendPak



Price Does Not Include Vehicles, Installation or Optional Equipment as Shown

Dual-Width, 9,000 Lbs. 2 Post Lift, Floor Plate, Short Lift

SKU 296813 BENXPR-9S **2,949⁹⁹**

- Shorter Columns for Low-Ceiling Installations
- Adjustable Width Design Configures for Wide or Narrow Installation
- Large, 20" x 19" Steel Base Plates
- Overall Height: 113"
- Inside Columns: 105"-118"

(Truck Adapters Included)



BendPak

Price Does Not Include Vehicles, Installation or Optional Equipment as Shown

Low-Profile Arms, Dual-Width, 9,000 Lbs. 2 Post Lift, Floor Plate, Short Lift

SKU 296927 BENXPR-9S-LP **2,999⁹⁹**

- Shorter Columns for Low-Ceiling Installations
- Adjustable Width Design Configures for Wide or Narrow Installation
- Telescoping Low-Pro™ Arms Accommodate Lowered Sports Cars
- Large, 20" x 19" Steel Base Plates
- Overall Height: 113"
- Inside Columns: 105"-118"

(Truck Adapters Included)



BendPak

Price Does Not Include Vehicles, Installation or Optional Equipment as Shown

9,000 Lbs. 2 Post Lift

SKU 499660 FORBP9 **3,199⁹⁹**

- Overall Height: 111-1/4" (2,826 mm)
- Minimum Ceiling Height: 113"
- Overall Width: 138-1/2" (3,518 mm)
- Minimum Adapter Height: 3-1/2"
- Adapter Extenders Included
- ETL Certified

Low Ceilings Are No Problem!

Price Does Not Include Installation or Optional Equipment as Shown

(Truck Adapters Included)



FORWARD
LIFT

Challenger CLFP9 9,000 Lbs. Floor Plate 2 Post Lift

SKU 851779 CHLCLFP9 **3,399⁹⁹**

- 3 Stage Front and Rear Arms Provide Excellent Reach to Lift a Variety of Vehicles
- Drive-Thru Clearance: 98-3/16"
- Minimum Ceiling Height: 121-7/8"
- Double Telescoping Screw Pads Adjust to Multiple Heights Minimizing the Need for Adapters

Price Does Not Include Vehicles, Installation or Optional Equipment as Shown



CL Challenger Lifts

12,000 Lbs. Floorplate, Direct-Drive 2 Post Lift

SKU 297199 BENXPR-12FDL **5,049⁹⁹**

- Open-Top Eliminates Overhead Obstruction
- Versatile Drop-In Contact Pads with Stackable 8-Piece Truck and Van Adapters
- Frame Cradle Pads Come Standard
- Triple-Telescoping, Low-Profile Arms
- Overall Height: 144"
- Inside Columns: 118"

(Truck Adapters and Frame Cradle Pads Included)



BendPak

Price Does Not Include Vehicles, Installation or Optional Equipment as Shown

QuickCycle™: Rise Time 27 Seconds!

CL10 Versymmetric® 10,000 Lbs. 2 Post Dual Pendant Controls QuickCycle™ Lift

SKU 851780 CHL10V3DPCQC **5,399⁹⁹**

- Featuring Dual Pendant Control System – Operate Lift from Either Column
- Versymmetric 3 Stage Front and 3 Stage Rear Arms
- Safely Lift Everything from Small Sedans to Trucks and SUVs
- Comes Standard with a Full Set of Adapters and Adjustable Foot Pads

Price Does Not Include Vehicles, Installation or Optional Equipment as Shown



Express Solution CL10-XP9 9,000 Lbs. QuickCycle™ 2 Post Pad Lift

SKU 851783 CHLCL10XP9QC **6,799⁹⁹**

- 2-1/4" Platform Height
- Open Front and Rear for Complete Vehicle Access
- Comes Standard with a Full Set of Rubber Spotting Blocks



CL Challenger Lifts



Price Does Not Include Vehicles, Installation or Optional Equipment as Shown

2 Post Lift Accessories

Rubber 2 Post Lift Pad/ Slip Over/ Round - 1 Each

SKU 343396 BEN5715017 **24⁹⁹**

- Slip Over Rubber Lift Pad for Use with BendPak 2 Post Lifts with Round Flat Contact Pads (Sold Individually)



BendPak

Square Rubber Arm Pads - 1 Each

SKU 898880 BEN5715365 **24⁹⁹ Each**

- Works with Any BendPak 2 Post Lift
- 5-5/8" Square
- 1-1/16" Thick

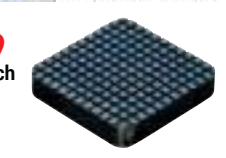

BendPak

Frame Cradle Pad - 1 Each

SKU 466304 BEN5215506 **54⁹⁹**

- Works with Any BendPak 2 Post Lift
- Tactile Rubber Mat Reduces Slippage and Protects Finish



Dannmar Frame Cradle Pad - 1 Each

SKU 289999 DAN119527 **49⁹⁹**



Dannmar
EQUIPMENT

I10 2 Post Carriage Door Bumper Kit

SKU 568451 FORTPB10-D1 **59⁹⁹**

- Use with Forward FORI10



FORWARD
LIFT

Round Rubber Lift Pad Assembly Drop-In - 1 Each

SKU 343397 BEN5215507 **59⁹⁹**

- Works with Any BendPak 2 Post Lift
- 1 Lift Pad, Sold Individually
- 5" Diameter for Enhanced Stability
- Easy Drop-In Design



FORWARD
LIFT

I10 Rubber Adapter Pad Kit

SKU 568440 FOR994105 **99⁹⁹**

- Use with Forward FORI10
- Eliminates Metal to Metal Contact at Vehicle Lift Points
- Includes (4) Pads and Attaching Hardware



FORWARD
LIFT

I10 2 Post Lift Adjustable Adapters - Set of 4

SKU 568450 FORT100285 **299⁹⁹**

- Use with Forward FORI10
- Included Rubber Pad Eliminates Metal to Metal Contact
- Adapters Designed to Cradle Frames



FORWARD
LIFT

Don't Let the Tire Make You Tired!

Omega Wheel Arm™

SKU 573207 OMG92100 **89⁹⁹**

- Holds the Tire at Lift Arm Height and is Handy with Tire Rotations and Brake Jobs
- Easy and Safe for Mechanics to Put On or Take Off Tires
- Avoid Bending Over to Put Down or Pick Up a Tire
- Fits Most Lift Arms 3" - 5" Wide
- Set Includes (2) Wheel Arms and (2) Magnetic Tool Trays



Price Does Not Include Tires or Rims as Shown

INCLUDES:
2 Round Magnetic Trays

Set of 2 **\$19⁹⁹ Value**

While Supplies Last



4 Post Lift Accessories

2 Drip Trays

SKU 301768 BEN5700301 **69⁹⁹**



BendPak

Caster Wheel Set

SKU 898905 BEN5210997 **289⁹⁹**

- For Use on HD-9 Series Lift Only



Rolling Oil Drain

SKU 898714 BENDP-30 **379⁹⁹**

- Adjustable Width: 33" - 60"
- 15 Gallon Capacity



Free Delivery!
in 48 Continental United States

Specifications Subject to Change without Notice or Liability.
Prices Do Not Include Vehicles, Installation or Optional Equipment as Shown.

Customers Responsible for Off-loading Equipment Upon Arrival.
Ask Your Sales Rep for Details.

Leasing Terms Available.†
Ask Your AutoZone® Commercial Sales Manager.

AUTOMOTIVE LIFTS

4 Post Lifts

Major D-12™ 12,000 Lbs. 4 Post Lift

SKU 343410
DAN1375681 **3,799⁹⁹**

- Single Hydraulic Cylinder Mounted Underneath Runway
- Internal "Anti-Sway" Slider Blocks in Each Column
- Features Heavy Duty 1/2" Aircraft Cable
- Oversized Self-Lubricating Cable Rollers
- Rugged 1-3/8" Roller Axles
- Multi-Position Safety Locks in Each Column
- Ramps Feature Non-Skid Surface Column
- Push-Button Safety Release
- Runways Adjust for Different Tread Widths



Price Does Not Include Vehicles, Installation or Optional Equipment as Shown

Rolling Jacks Sold Separately

WORKS WELL WITH



14,000 Lbs. 4 Post Lift

SKU 898152
BENHDS14 **4,449⁹⁹**

- Overall Width: 130"
- Overall Length: 241"
- Max. Rise: 70"
- Motor: 220 VAC/1 Ph



Price Does Not Include Vehicles, Installation or Optional Equipment as Shown

(Shown with Optional Equipment)

Rolling Jacks Sold Separately

WORKS WELL WITH



4 Post 6,000 Lbs. Rolling Bridge Jack DRJ-6

SKU 343411
DAN1375901 **999⁹⁹**



(Optional Equipment)

RJ-7 7,000 Lbs. Capacity Rolling Bridge Jack

SKU 212556
BENRJ-7 **1,319⁹⁹**



(Optional Equipment)

14,000 Lbs. 4 Post Lift

SKU 696483
FORCR14N100 **4,499⁹⁹**

- Heavy Duty Hydraulic Cylinder
- Single Point Latch Release System
- 78-3/4" Rise
- 18 Lock Positions
- Accommodates 182-1/2" Wheelbase Vehicles
- High Performance Cable and Sheave System
- ETL Certified



Price Does Not Include Installation or Optional Equipment as Shown

WORKS WELL WITH

Rolling Jacks Sold Separately



Challenger 4P14 14,000 Lbs. 4 Post Lift

SKU 851781
CHL4P14EFX **4,899⁹⁹**

- Louvered Approach Ramps for Positive Vehicle Traction
- Adjustable Runways to Accommodate a Variety of Tread Widths
- Column Height: 90-1/2"
- Minimum Bay Size: 12" x 24"



Rolling Jacks Sold Separately

Price Does Not Include Vehicles, Installation or Optional Equipment as Shown

WORKS WELL WITH



18,000 Lbs. 4 Post General Service Lift

SKU 568426
FORCR18 **7,999⁹⁹**

- Max. Wheelbase: 194"
- Durable Cable and Sheave System
- ETL Certified to ANSI/ALI ALCVT: 2011



Price Does Not Include Vehicles, Installation or Optional Equipment as Shown

Rolling Jacks Sold Separately

WORKS WELL WITH



7,000 Lbs. Rolling Jack

SKU 568445
FORRRJ70G **1,999⁹⁹**

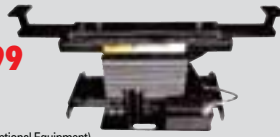

(Optional Equipment)

7,500 Lbs. Rolling Jack

SKU 264847
CHLRJ75 **2,054⁹⁹**



(Optional Equipment)

9,000 Lbs. Rolling Jack

SKU 568446
FORRJ901000 **2,999⁹⁹**



(Optional Equipment)

SAVE \$999⁹⁹

Two 7K Rolling Jacks
SKU 434708
FORRRJ70GBOGO **2,999⁹⁹**
• Great Savings - Buy 1st RJ7.50G at Regular Price, Get the Second One 1/2 Price
• Includes 2, Air/Hydraulic Rolling Jacks with (4) 3" Stack Adapters



SAVE \$1,109⁹⁹

Two 7.5K Rolling Jacks
SKU 851169
CHLRJ75BOGO **2,999⁹⁹**
• Includes (2), Air/Hydraulic Rolling Jacks with (4) 3" Stack Adapters
• 7,500 Lbs. Capacity for 4P14 & 4015 Series 4 Post Lifts



SAVE \$1,499⁹⁹

Two 9K Rolling Jacks
SKU 435068
FORRJ901000BOGO **4,499⁹⁹**
• Great Savings - Buy 1st RJ901000 at Regular Price, Get the Second One 1/2 Price
• Includes 2, Air/Hydraulic Rolling Jacks with (4) 3" Stack Adapters



Storage Lifts

9,000 Lbs. Free Standing or Surface Mounted 4 Post Lift - Standard Height

SKU 264504
CHLQ4P09H **3,499⁹⁹**

- Rise: 73-1/4"
- Overall Width: 112-3/4"
- Overall Length (with Ramps Attached): 209-1/2"
- Inside Columns: 95"
- Height of Columns: 84-1/2"
- Width of Runways: 20"
- Height of Runways: 7"
- Width Between Runways: 38"
- Length of Runways: 164"

Price Does Not Include Vehicles, Installation or Optional Equipment as Shown



Caster Set
SKU 264473
CHLQ4P09CS **229⁹⁹**

Rolling Jacks Sold Separately

WORKS WELL WITH

9,000 Lbs. 4 Post Lift

SKU 898142
BENHD-9 **2,949⁹⁹**

- Overall Width: 116-3/4" (2,965 mm)
- Overall Length: 200" (5,080 mm)
- Column Height: 88" (2,235 mm)
- Max. Lifting Height: 74-1/2" (1,892 mm)



Price Does Not Include Vehicles, Installation or Optional Equipment as Shown

Rolling Jacks Sold Separately

WORKS WELL WITH

9,000 Lbs. 4 Post Lift

SKU 499672
FOREFP9 **3,399⁹⁹**

- Includes: Steel Approach Ramps, Jack Tray, Wheel Caster Kit and Drip Trays
- Single Point Lock Release
- Internal Lock System
- ETL Certified



Price Does Not Include Vehicles, Installation or Optional Equipment as Shown

Rolling Jacks Sold Separately

WORKS WELL WITH

8,000 Lbs. EFP8 Home Storage 4 Post Lift

SKU 818781
FOREFP8P000M **2,799⁹⁹**

- Perfect for Home Use
- Includes: Steel Approach Ramps, Jack Tray, Wheel Caster Kit and Drip Trays
- Wired to Plug Into 115V Receptacle



Price Does Not Include Vehicles, Installation or Optional Equipment as Shown

Rolling Jacks Sold Separately

WORKS WELL WITH

7,000 Lbs. 4 Post Home Storage / Light-Duty Service Lift

SKU 383185
CHLQ4P07 **3,199⁹⁹**

- Rise Height Underneath Runway: 68-1/8"
- Outside to Outside Columns: 100-1/2"
- Overall Length (with Ramps): 195-1/2" (without Ramps) 165"
- Inside Columns: 92"
- Height of Columns: 79-1/2"
- Width of Runways: 20"
- Height of Runway: 5-3/4"
- Width Between Runways: 38"
- Length of Runways: 150"
- Detachable Aluminum Approach Ramp Length: 36"
- 13 Lock Positions
- 1HP 110 Volt Plug-In or 220V Power

Price Does Not Include Vehicles, Installation or Optional Equipment as Shown



Rolling Jacks Sold Separately

WORKS WELL WITH

Commander D-7

SKU 186464
DAN1375643 **2,449⁹⁹**

- Spring-Loaded Safety Locks on Each Column
- Self-Lubricating UHMW Polyethylene Internal Slide Blocks
- Single Safety Lock Release Handle
- 7,000 Lbs. Capacity Free Standing Design
- Detachable Drive-Up Ramps Included



Price Does Not Include Vehicles, Installation or Optional Equipment as Shown

Rolling Jacks Sold Separately

WORKS WELL WITH

4,500 Lbs. Hand/Hydraulic Operated Rolling Jack

SKU 264841
CHLQRJ04H **899⁹⁹**



(Optional Equipment)

RJ-45 4,500 Lbs. Capacity Rolling Bridge Jack

SKU 898534
BENRJ-45 **1,194⁹⁹**

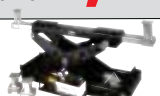

(Optional Equipment)

4,500 Lbs. Rolling Jack

SKU 568432
FORRRJ45G **999⁹⁹**



(Optional Equipment)

3,500 Lbs. RJ35BK Hand Pump Rolling Jack

SKU 818764
FORRJ35BK **699⁹⁹**



(Optional Equipment)

3,500 Lbs. Hand/Hydraulic Operated Rolling Jack

SKU 383186
CHLQRJ03H **599⁹⁹**



(Optional Equipment)

Jack Platform

SKU 186438
DAN119442 **139⁹⁹**



(Jacks not included)

Free Delivery!
in 48 Continental United States

Specifications Subject to Change without Notice or Liability. Customers Responsible for Off-loading Equipment Upon Arrival.

Leasing Terms Available.*
Ask Your AutoZone® Commercial Sales Manager.

Leasing Terms Available!†

Ask Your AutoZone®
Commercial Sales Manager

AutoZone®
Tool & Equipment QUARTERLY

Lift Accessories

Air/Electric Workstation for 2 and 4 Post Lift

SKU 751635 **239⁹⁹**
DAN1980999

- Add 20 Amp Outlets, Air Functionality and Tool/Line Holders by Attaching This Workstation to Your 2 and 4 Post Lift



Air/Electric Workstation

SKU 898684 **314⁹⁹**
BENWSA-100

- Adds Air and Electric Capabilities to Any BendPak Lift Simple
- Safe and Extremely Easy-to-Use
- (4) 110V GFI Outlets, Oiler, Air Supply, Pressure Gauge, Storage Hooks for Hose and Tools, Regulator/Filter, Air Inlet
- Fits 2 or 4 Post Lifts

You Will Need to Know BendPak Lift Model # When Ordering



Air/Electric Workstation for 2 and 4 Post Lifts

SKU 263294 **349⁹⁹**
CHL10310

- Convenient Power Source for Extension Lights and Other Tools
- Air Supply Will Always Be at Arms Reach for Facilities Using Pneumatic Tools Such as Impact Wrenches



Air/Electric Workstation

SKU 568448 **369⁹⁹**
FOR991359

- Use with Forward FOR110
- Air/Electric Workstation with Air Regulator and Oiler

Does Not Include Hose and Air Gun



Mid-Rise Lifts

Cadet-6000XL

SKU 555446 **1,749⁹⁹**
DAN1375652

- For Servicing Light-Duty Cars and Trucks
- Portable Motor Cart Serves as Tow Handle
- Adjustable Arm Assemblies
- Safety Bar with Multiple Lock Positions



Lift Gate Service
SKU 262534
DANLIFTGATE **100⁰⁰**



Price Does Not Include Vehicles, Installation or Optional Equipment as Shown

6,000 Lbs. Portable Mid Rise Lift

SKU 264835 **2,099⁹⁹**
CHLQMR6

- Rise Height: 53-1/4"
- Includes Both 3" and 6-7/8" Adapters

Lift Gate Service
SKU 295540
DEMLIFTGATE **80⁰⁰**



Price Does Not Include Vehicles, Installation or Optional Equipment as Shown

6,000 Lbs. Surface Mount Mid-Rise Pad Lift

SKU 079537 **2,449⁹⁹**
BENMDS-6K

- For Servicing Passenger Cars, SUVs and Light-Trucks
- Lifting Height (Less Lift Blocks): 44"
- Comes with Four Rubber Contact Blocks Providing Fast Vehicle Set-Up

6,000 Lbs. Flush Mount Mid-Rise Pad Lift

SKU 079653 **2,349⁹⁹**
BENMDS-6KF

- Fully Open Center Design for Servicing Passenger Cars, SUVs and Light-Trucks
- Lifting Height (Less Lift Blocks): 44" (4.25" for Sub Floor)
- Includes Four Rubber Contact Blocks Providing Fast Vehicle Set-Up



Price Does Not Include Installation or Optional Equipment as Shown

6,000 Lbs. Mid-Rise Lift

SKU 499655 **1,999⁹⁹**
FOR600MRL

- Width: 41"
- Rise: 52"
- Length: 83"
- Multiple Locking Positions
- Truck Adapters Included

Lift Gate Service
SKU 626137
FORLIFTGATE **95⁰⁰**



Price Does Not Include Vehicles, Installation or Optional Equipment as Shown

6,000 Lbs. Portable Mid-Rise Lift

SKU 210386 **2,094⁹⁹**
BENMD-6XP

- Portable, Easy to Move from Bay-to-Bay
- Adjustable Arms

Lift Gate Service
SKU 262533
RANLIFTGATE **135⁰⁰**

(Truck Adapters Included)



Price Does Not Include Installation or Optional Equipment as Shown

MaxJax™

SKU 186434 **1,999⁹⁹**
DAN1375659

- Perfect for Low Clearance Ceilings and Home Garages
- Built-In Wheels That Allow You to Store it Out of the Way When Not in Use
- Max. Lift Height (with 3" Adapter): 52"

Lift Gate Service
SKU 262534
DANLIFTGATE **100⁰⁰**



Price Does Not Include Vehicles, Installation or Optional Equipment as Shown

Low-Rise Lifts

6,000 Lbs. Low-Rise Pad Lift

SKU 210383 **1,739⁹⁹**
BENLR-60

- Max. Height: 26"
- Overall Width: 70"
- Overall Length: 82"

Lift Gate Service
SKU 262533
RANLIFTGATE **135⁰⁰**

Price Does Not Include Vehicles, Installation or Optional Equipment as Shown



Portable

SKU 210384 **1,819⁹⁹**
BENLR-60P

- Max. Height: 26"
- Overall Width: 70-1/2"
- Overall Length: 82"

7,000 Lbs. Low-Rise Pad Lift

SKU 568436 **2,349⁹⁹**
FORTLO7

- Wired to Plug Into 115V Receptacle
- Max. Rise: 24-3/4"

Lift Gate Service
SKU 626137
FORLIFTGATE **95⁰⁰**



Price Does Not Include Installation or Optional Equipment as Shown

10,000 Lbs. Low-Rise Pad Lift

SKU 479989 **2,799⁹⁹**
BENLR-5T

- Max. Height: 23" - 32"
- Lowered Height: 4"
- Lift Blocks Included

Lift Gate Service
SKU 262533
RANLIFTGATE **135⁰⁰**



Price Does Not Include Installation or Optional Equipment as Shown

QuickJack™

5,000 Lbs. QuickJack™ Car Jack Support System

SKU 850896 **1,339⁹⁹**
RANBL5000SLXA (110V AC)

- Complete Package Includes: (2) Jack Frame Assemblies, (2) 150" Hydraulic Hoses, (2) 14" Aux. Hoses, (2) Quick-Mount Handles, (4) 1.5" X 3" X 4" Rubber Lifting Blocks, (4) 3" X 3" X 4" Rubber Lifting Blocks, (1) Mini Hydraulic Power Unit with Pendant Control

You get it all.

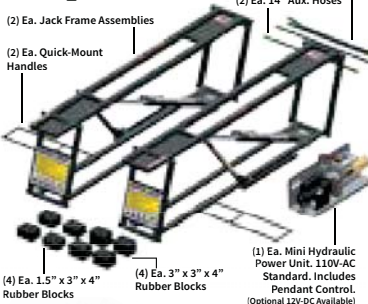

Price Does Not Include Vehicles, Installation or Optional Equipment as Shown.

3,500 Lbs. QuickJack™

SKU 850894 **1,124⁹⁹**
RANBL3500SLXA (110V AC)

7,000 Lbs. QuickJack™

SKU 850897 **1,489⁹⁹**
RANBL7000SLXA (110V AC)

12V DC Option Available

QUICKJACK™

QuickJack™ SUV and Light Truck Adapters

SKU 862288 **219⁹⁹**
RAN1510561

- Set of 12 Pieces
- Fits BL-5000 and BL-7000 Series
- Complete Kit Includes: (4) Low-Profile Round Polyurethane Contact Pads (4) Sliding Receivers Accommodate the Round Polyurethane Contact Pads (4) 3" Stackable Adapters

SPECIFICATIONS:	BL-3500SLX	BL-5000SLX	BL-7000SLX
Weight Capacity / Pair	3,500 Lbs. / 1588 kg.	5,000 Lbs. / 2268 kg.	7,000 Lbs. / 3175 kg.
Individual Frame Weight:	60 Lbs. / 27 kg.	76 Lbs. / 34 kg.	91 Lbs. / 41 kg.
Platform Lifting Height (Frame Only)	16.5" / 419 mm.	17.2" / 437 mm.	17.7" / 450 mm.
Platform Lifting Height (W/Blocks)	20" / 508 mm.	22.5" / 572 mm.	21.2" / 538 mm.
Minimum Collapsed Height	3" / 76 mm.	3" / 76 mm.	3.5" / 89 mm.
Rubber Block Position Min	26.7" / 678 mm.	31.5" / 800 mm.	31.5" / 800 mm.
Rubber Block Position Max	50.5" / 1283 mm.	60" / 1524 mm.	60" / 1524 mm.
Frame Width	10.5" / 267 mm.	11" / 278 mm.	12.5" / 318 mm.
Frame Length	62" / 1575 mm.	72.5" / 1841 mm.	72.5" / 1841 mm.
Lifting Time	10 seconds	15-30 seconds	15-30 seconds

Motorcycle Lifts

Motorcycle Jack

SKU 568452 **194⁹⁹**
FORBJ10

- Use with Forward FOR100MCL



1,000 Lbs. Air Operated Motorcycle Lift

SKU 499659 **1,049⁹⁹**
FOR1000MCL

- Includes Wheel Vise and Two 12" Extensions, Making it Great for Motorcycles, ATVs, Lawn Mowers, Golf Carts, Etc.
- Rise 33", Length 93", Width 24", Width with ATV Adapters 48"

Lift Gate Service
SKU 626137
FORLIFTGATE **95⁰⁰**

Price Does Not Include Vehicles, Installation or Optional Equipment as Shown



1,000 Lbs. Droptail Motorcycle Lift

SKU 568439 **1,249⁹⁹**
FOR1000CLDT

- FORBJ10 Included
- Rise 33" Length 93", Width 24"

Lift Gate Service
SKU 626137
FORLIFTGATE **95⁰⁰**

Price Does Not Include Vehicles, Installation or Optional Equipment as Shown



Motorcycle Lift

SKU 626120 **1,449⁹⁹**
RANRML-1500XL

- Lifting Capacity: 1,500 Lbs. (682 kg)
- Power Supply: Air/Hydraulic
- Main Platform Length: 89" (2,286 mm)
- Main Platform Length with Front Extension: 102" (2,591 mm)
- Main Platform Width: 30" (762 mm)

Lift Gate Service
SKU 262533
RANLIFTGATE **135⁰⁰**

Price Does Not Include Vehicles, Installation or Optional Equipment as Shown



TUXEDO
Distributors, LLC.
Automotive Equipment & Accessories

Tuxedo Distributors, LLC, is a leading importer of high quality automotive repair equipment offering a full line of automotive equipment at an economical price. With our 10 satellite warehouses strategically located across the US, we offer an unparalleled competitive advantage.

Call to place order!

817.558.9337

877.558.9337 Toll Free

TWO POST LIFTS

TLT240SC-R 2,099⁹⁹
9,000lbs CAPACITY
SKU 426404

- TLT240SB-R** 1,999⁹⁹
9,000lbs CAPACITY
SKU 426403
- Overall Height: 151" (TLT240SC)
 - Overall Width: Symm 134", Asym 140" (TLT240SC)
 - Overall Height: 151" (TLT240SB)
 - Overall Width: 133" (TLT240SB)
 - Rubber Door Guards
 - Hose Guards
 - Stackable Footpad Extensions - four 3.5"
 - Dual Point Lock Release
 - Heavy-Duty Arm Restraint System
 - Double Telescoping Screw Pads
 - Adjustable Column Width (TLT240SC)
 - Standard or Rotated Asymmetric Columns (TLT240SC)

LAUNCH



TP9KACX 1,849⁹⁹
9,000lbs CAPACITY
SKU 426138

- TP9KFX** 1,849⁹⁹
9,000lbs CAPACITY
SKU 426106
- Overall Height: 143" (TP9KACX)
 - Overall Width: 135" (TP9KACX)
 - Overall Height: 152" (TP9KFX)
 - Overall Width: 134.5" (TP9KFX)
 - Chain Driven
 - Dual cylinders with low friction chain rollers
 - Low profile arms
 - Spin Up Pads with 1-1/2" and 4" stackable drop-in height adapters
 - Padded overhead shut off bar
 - Powder-Coated Finish
 - Rubber Door Guards



TLT210-XT-B 2,799⁹⁹
10,000lbs CAPACITY
SKU 426407

- Overall Height: 140"
- Overall Width: Symm 137", Asym 138"
- Heavy-Duty Arm Restraint System
- Adjustable Column Height
- Adjustable Column Width
- Outer Hose Guards
- Stackable Foot Pad Extensions four 6" and four 3"
- 3 Stage Front Arms
- Rubber Door Guards
- Single Point Lock Release
- Standard or Rotated Asymmetric Arm Configuration
- Double Telescoping Screw Pads

*Available in red and blue

LAUNCH TECH USA



TP11KC-DX 2,599⁹⁹
11,000lbs CAPACITY
SKU 426140

- Direct "Full" Cylinders
- Overall Height: 145"
- Overall Width: 145-1/2"
- 3 Stage Front Arms, Low Profile Arms
- Asymmetric/Symmetric Arm Configurations
- Symmetric Columns
- Single Point Lock Release
- Rubber Door Guards
- Spin Up Pads with 2" and 4" stackable drop in Height Adapters
- Powder Coated Finish
- Padded Overhead shut off bar

Price Does Not Include Installation or Optional Equipment as Shown



TLT211AS-R 3,299⁹⁹
11,000lbs CAPACITY
SKU 426408

- Overall Height: 143"
- Overall Width: Symm 137.5", Asym 138"
- Heavy-Duty Arm Restraint System
- Adjustable Column Height
- Adjustable Column Width
- Outer Hose Guards
- Stackable Foot Pad Extensions four 6" and four 3"
- Heavy-Duty Arm Restraint System
- Rubber Door Guards
- Standard Asymmetric
- Double Telescoping Screw Pads

*Available in red and blue



Price Does Not Include Installation or Optional Equipment as Shown

TP12KC-DE 3,999⁹⁹
12,000lbs CAPACITY
SKU 426331

- Overall Height: 165"
- Overall Width: 151-1/8"
- Direct "Push Drive" Cylinders
- Extra Long (48") carriage
- Padded Overhead shut off bar
- Single Point Pneumatic Lock Release
- 2-1/2" and 5" Stackable Drop in Adapters
- Powder-Coated finish

Price Does Not Include Installation or Optional Equipment as Shown



TP15KCX 4,249⁹⁹
15,000lbs CAPACITY
SKU 426389

- Overall Height: 160"
- Overall Width: 145"
- Chain Drive
- Padded Overhead shut-off bar
- Dual Point Lock Release
- Large 2" x3" Base Plates for Stability
- Rubber Door Guards
- Hose Guards
- Low Pad Height 5"
- Spin-Up Pads w/ 3" and 5" Stackable Drop-in Adapters
- Heavy Duty Arm Restraints
- Powder-Coated finish



Price Does Not Include Installation or Optional Equipment as Shown

FP8K-DX 2,399⁹⁹
8,000lbs CAPACITY
SKU 426414

- Overall Height: 85-1/4"
- Overall Weight: 103-1/2"
- Overall Length: 207-1/8"
- Ladder lock safety system with "auto engage" locking bar
- Extra-large slider blocks for added stability
- 10 Lock Positions
- Aircraft quality cables
- Single Point Lock Release
- 15" Wide non-skid, diamond plate runways
- Poly Casters, Jack Tray, Drip Trays, and Approach Ramps included

*Also available in an "XLT" extended length and height version"



STORAGE LIFT

Price Does Not Include Installation or Optional Equipment as Shown

SERVICE LIFT



Price Does Not Include Installation or Optional Equipment as Shown

FP14K-C 4,749⁹⁹
14,000lbs CAPACITY
SKU 426438

- Overall Height: 65-7/8"
- Overall Width: 136-3/4"
- Overall Length: 250-1/2"
- Cable Driven
- Closed Front
- Single point pneumatic safety release
- 20" wide non-skid, diamond plate runways
- Mounting Hardware included
- Powder-Coated Finish

Also sold as an Alignment Lift



Price Does Not Include Installation or Optional Equipment as Shown

Bridge Jacks sold separately

FP14K-A 6,999⁹⁹
14,000lbs CAPACITY
SKU 426445

- Overall Length: 291"
- Overall Width: 120"
- Width Between Post: 116"
- Column Height: 92"
- Lifting Height: 73"
- Open Front Design
- Extended Length / Extended Wheel base
- Cable Driven
- Powder-Coated finish
- 20" wide non-skid, diamond plate runways
- Fully adjustable lock stops for easy leveling

BRIDGE JACK



Price Does Not Include Installation or Optional Equipment as Shown

RAJ-8K-L 1,449⁹⁹
8,500lbs CAPACITY
SKU 426452

- Universal Roller Body Design w/dual 'spring loaded' precision roller bearing and Side Guide Wheels w/adjustable Height for Low, Medium, and High Jack Rail Configurations
- Rolls on top edge of Jack Rail for smooth maneuverability
- Dual Height Telescoping Support Arms
- Pneumatic operation w/adjustable Pressure Regulator
- Stackable Pad and Height Adapters 1 5/16" and 5" (1 Pair each)
- Dual Air Bags

Price Does Not Include Installation or Optional Equipment as Shown

IWA-60-1500-K 9,199⁹⁹
Image Wheel Aligner
SKU 592176

- High Resolutions Cameras
- Mobile Multi-Bay Capable
- Non-proprietary Windows PC
- Wireless Internet Connection
- German Engineered Alignment Software
- Advanced Alignment Measurements with Reading/Specifications and Cross Values
- Comprehensive Database 25+ Spec Years

ALIGNER

IDEAL

- Illustration Diagrams
- Integrated Help System
- Non-proprietary Windows PC
- Works with multiple style alignment lifts
- Expert USA Technical support
- UPS with Avrt included

TUXEDO

Distributors, LLC.

Automotive Equipment & Accessories

Tuxedo Distributors, LLC, is a leading importer of high quality automotive repair equipment offering a full line of automotive equipment at an economical price. With our 10 satellite warehouses strategically located across the US, we offer an unparalleled competitive advantage.

Call to place order!

817.558.9337

877.558.9337 Toll Free

WHEEL SERVICE

TC-530
Semi-Automatic
Tire Changer
SKU 426751

1,349⁹⁹

- Internal Clamping Capacity: 12" - 23"
- External Clamping Capacity: 10" - 20"
- Max Wheel Diameter: 36"
- Wheel Width: 3" - 12"
- Swing arm design
- Bead seating inflation jets are integrated in the clamping jaws
- Side mounted Bead Breaker

Price Does Not Include Installation or Optional Equipment as Shown



TC-980
Deluxe
Tire Changer
SKU 426758

4,399⁹⁹

- Max Wheel Diameter: 47-1/4"
- Rim Width: 3" - 15"
- Rim Diameter: 15" - 28"
- Working Pressure: 8-10 bar
- Large tire
- Fully automatic
- Double arm
- Tilt back
- Pressure limiter, water separator and oiler are standard

Price Does Not Include Installation or Optional Equipment as Shown



WB-953
High Performance
Wheel Balancer
SKU 426803

1,099⁹⁹

- Max Wheel Diameter: 28"
- Rim Width: 1.5" - 20"
- Rim Diameter: 10" - 24"
- Wheel Weight Capacity: 150 lbs
- Self-calibrating, Self-diagnosis
- Optimization program

- Static balancing
- Three centering cones
- Hood, hammer, speed nut and caliper cone standard
- Optional motorcycle adapter is available

Price Does Not Include Installation or Optional Equipment as Shown



TC-950
Semi-Automatic
Tire Changer
SKU 426755

1,499⁹⁹

- Max Wheel Diameter: 47"
- Rim Width: 3" - 15"
- Rim Diameter: 15" - 28"
- Working Pressure: 8-10 bar
- Swing arm design
- No scratching. Machine contacts rim eliminating accidental damage
- Conveniently located and powerful bead breaker

Price Does Not Include Installation or Optional Equipment as Shown



TC-1300
Leverless
Tire Changer
SKU 426761

3,499⁹⁹

- Max Wheel Diameter: 41"
- Rim Width: 3" - 15"
- Rim Diameter: 11" - 24"
- Leverless Design allows for user safety and convenience
- Powerful dual bead blaster jets
- Inflation hose and air gauge
- Tilt back column leaves ample room for operation
- 3 function axial arm adds versatility in demounting low profile tires

Price Does Not Include Installation or Optional Equipment as Shown



WB-CB66-VE
High Performance
Large Wheel Balancer
SKU 592163

1,249⁹⁹

- Keypad Data Entry
- Max Wheel Diameter: 44"
- Rim Width: 1.5" - 20"
- Rim Diameter: 8" - 28"
- Wt Weight Cap: 150lbs
- Accuracy: 1 gram
- Three centering cones
- Hood, hammer, speed nut and caliper cone standard
- Multi-Mode Balancing for SUV/Car & Motorcycle
- Laser and Light indicators for unbalanced wheel weight positions
- Foot Brake for accurate weight applications

Price Does Not Include Installation or Optional Equipment as Shown



TC-950WPA
High Performance
Tire Changer with Press Arm
SKU 426757

2,399⁹⁹

- Internal Clamping Capacity: 15" - 28"
- External Clamping Capacity: 13" - 24"
- Max Wheel Diameter: 47"
- Wheel Width: 3" - 15"
- Swing arm design
- Bead seating inflation jets are integrated in the clamping jaws
- Twin clamping cylinders provide more power to hold the most difficult rims
- Conveniently located and powerful bead breaker
- Large diameter lens mount/demount shaft for extra rigidity
- Left side press arm (WPA)
- Ideal for low profile tires (WPA)
- No scratching, machine never contacts rim (WPA)



Price Does Not Include Installation or Optional Equipment as Shown

Additional charges for lift gate delivery may apply.

WB-448
Heavy Duty Truck
Wheel Balancer
SKU 426811

2,499⁹⁹

- Max Wheel Diameter: 47"
- Rim Width: 1.5" - 20"
- Rim Diameter: 10" - 24"
- Wheel Weight Capacity: 268 lbs
- Self-calibrating, Self-diagnosis
- Pneumatic Wheel lift included
- Foot brake for manual stop
- Capable of balancing a full range of wheels
- Car and Truck cones come standard

Price Does Not Include Installation or Optional Equipment as Shown



FRAME MACHINES

FR-77-18
Steel Plate / 18"
SKU 426651

12,799⁹⁹

FR-77-20
Steel Plate / 20"
SKU 592195

13,799⁹⁹

FR-77T-18
Tubular / 18"
SKU 592192

10,499⁹⁹

FR-77T-20
Tubular / 20"
SKU 592193

10,999⁹⁹

FR-55
Scissor Lift
Frame Rack Machine
SKU 426649

9,999⁹⁹

- Lifting Capacity: 5,500 lbs.
- Overall Length: 173.25"
- Deck Length: 123.62"
- Deck Width: 37"
- Deck Height: 4.75" to 63"
- Tower Pull Force: 10 Ton
- Tower Air-Hydraulic Max Pressure: 10,000 PSI
- Console Electrical Power: 220VAC - 20 Amp, 1 PH
- Unique, Compact & Versatile design
- Scissor Lift operation with Twin Hydraulic Cylinders
- Remote "hand held" pendant for lift operation
- Multi-Angle, 360 degree Pulling Capability

Price Does Not Include Installation or Optional Equipment as Shown



- Lifting Capacity: 7,700 lbs
- Deck Length: 18" / 20"
- Deck Width: 82.6"
- Deck Height: 18.7"
- Pull Force Per Tower: 10 Ton
- Required Air Power: 100 - 120 PSI
- Designed to accommodate Full-frame or Uni-body type vehicle
- Hydraulic Tilt Deck operation
- Universal Anchoring System
- Clear Floor, 360 degree Pulling Capability
- Twin 10 Ton round Pull Towers w/telescoping Tower-Heads

*20 and 25 Piece Tool Board Kit Sold Separately

MOBILE COLUMN

MSC-6KLP

6,000 lbs
Single Column Lift
SKU 426460

2,999⁹⁹

- Capacity: 6,000 lbs
- Width Overall: 45-3/16"
- Height Overall: 102-3/8"
- Length Overall: 101-9/16"
- Improved Low Profile design with less than 4" minimum height!
- Pallet Style Operation
- Improved "double telescoping" Screw Pads with 2-3/4" adjustable height!
- Pallet Jack style hydraulics to raise lift onto wheels
- Single Point Lock Release
- Powder coat paint finish
- 110VAC / PN

Price Does Not Include Installation or Optional Equipment as Shown



PAINT BOOTHS

PSB-SEMIDD26ASY-AK
SEMI DOWN DRAFT
PAINT SPRAY BOOTH
SKU 592189

13,999⁹⁹

*Optional Plenum Kit Shown

- Inside Dimension: 26'L x 14'W x 9'3"H
- Outside Dimension: 29'-4"L x 14'-4"W x 9'-5"H
- Fan / Motor: 3HP-3PH-230V/480VAC-60HZ Non-Spark, NEMA RATED

- High Quality UL Listed lighting fixtures. (Bulbs Included)
- Hip Roof Design for Optimal Lighting
- 5/16" Nut & Bolt Installation
- High Quality Intake and Exhaust Filters
- Heavy Duty 18 Gauge Panel Construction
- Tri-fold and Personnel Doors with Viewing Windows
- Powder Coated Finish (Inside and Out)
- UL Control Panel, limit switches and solenoid valve included
- All hardware included
- Detailed Instructions
- Optional Plenum Kit Sold Separately

Price Does Not Include Installation or Optional Equipment as Shown



PSB-SDD26ASY-AK
SIDE DOWN DRAFT
PAINT SPRAY BOOTH
SKU 592190

14,999⁹⁹

*Optional Plenum Kit Shown

- Inside Dimension: 26'L x 14'W x 9'3"H
- Outside Dimension: 26'-4"L x 17'-8"W x 9'-5"H
- Fan / Motor: (2x) 3HP-3PH-230V/480VAC-60HZ Non-Spark, NEMA RATED

- High Quality UL Listed lighting fixtures. (Bulbs Included)
- Hip Roof Design for Optimal Lighting
- 5/16" Nut & Bolt Installation
- (2x) Exhaust Chimney Stack Assemblies Included
- High Quality Intake and Exhaust Filters
- Heavy Duty 18 Gauge Panel Construction
- Tri-fold and Personnel Doors with Viewing Windows
- Powder Coated Finish (Inside and Out)
- UL Control Panel, limit switches and solenoid valve included
- All hardware included
- Detailed Instructions
- Optional Plenum Kit Sold Separately

Price Does Not Include Installation or Optional Equipment as Shown



Dannmar® EQUIPMENT

PORTABLE LIFT

MaxJax™
SKU 186434
DAN1375659 **1,999⁹⁹**

- Lifting Capacity: 6,000-Lbs.
- Great for Garages with Low Ceiling Height
- 100% Portable



MaxJax

Price Does Not Include Vehicles, Installation or Optional Equipment as Shown

2-POST LIFTS

D-9/X
SKU 186430
DAN1375646 **2,699⁹⁹**

- Lift Capacity 9,000-Lbs.
- Floorplate Style
- Perfect for Shops and with Height Restrictions
- Rise: 74"



Price Does Not Include Vehicles, Installation or Optional Equipment as Shown

Truck Adapters Included

D-10/ACX
SKU 186433
DAN1375647 **2,499⁹⁹**

- Lifting Capacity: 10,000-Lbs.
- Great for Passenger Cars & SUV's
- Overall Height: 145"
- Rise: 69"
- Overall Width: 143-1/2"
- ASYMMETRIC WIDE



Truck Adapters Included

Price Does Not Include Vehicles, Installation or Optional Equipment as Shown

D-10/AC
SKU 186431
DAN1375648 **2,499⁹⁹**

- Overall Width: 130-1/2"
- ASYMMETRIC NARROW

D-10/CX
SKU 186432
DAN1375649 **2,499⁹⁹**

- Great for Lifting Light Duty Trucks
- Overall Width: 145"
- SYMMETRIC WIDE

BONUS
FRAME CRADLE PAD SET
\$199.96 Value



SCISSOR LIFT

SX-6
SKU 555446
DAN1375652 **1,749⁹⁹**

- Lifting Capacity: 6,000-Lbs.
- 100% Portable
- Perfect for Body, Repair & Tire Shops
- Safety Bar with Multiple Lock Positions



Price Does Not Include Vehicles, Installation or Optional Equipment as Shown

BONUS
8-GALLON OIL DRAIN
\$99.99 Value



WHEEL SERVICE

T-100 TIRE CHANGER
SKU 547117
DAN1381202 **1,599⁹⁹**

- Ideal for Low Volume Shops
- Entry Level and Easy to Use
- Wear-Resistant Tool Head
- Steel Jaw-Clamp Provides Solid Turn-Table Base
- High Torque Electric Turn-Table



Price Does Not Include Tires or Rims as Shown

Lift Gate Service
SKU 262534
DANLIFTGATE **100⁰⁰**

B-100 WHEEL BALANCER
SKU 547121
DAN1381201 **1,449⁹⁹**

- Excels in Low Volume Shops
- Touch-Display Panel
- Easy and Fast Mounting
- Power-Saving Mode
- Includes Data Acquisition and Quick Nut Mounting



Price Does Not Include Tires or Rims as Shown

4-POST LIFTS

D-12
SKU 343410
DAN1375681 **3,799⁹⁹**

- Lifting Capacity: 12,000-Lbs.
- Perfect for General Repairs
- Multi-Position Safety Locks in Each Column
- Max Rise: 66"



Price Does Not Include Vehicles, Installation or Optional Equipment as Shown

BONUS
AIR-ELEC WORKSTATION
\$219.99 Value



DRJ-6 ROLLING BRIDGE JACK (2 Required)
SKU 343411
DAN1375901 **999⁹⁹**



AIRLINE KIT
SKU 752035
DAN17057064 **219⁹⁹**



Price Does Not Include Vehicles, Installation or Optional Equipment as Shown

D-7
SKU 186464
DAN1375643 **2,449⁹⁹**

- Lifting Capacity: 7,000-Lbs.
- Perfect for Parking & Storing Vehicles
- Spring-Loaded Safety Locks on Each Column



Price Does Not Include Vehicles, Installation or Optional Equipment as Shown

D-7/X
SKU 186427
DAN1375644 **2,479⁹⁹**

- Extended version of D-7

Price Does Not Include Vehicles, Installation or Optional Equipment as Shown

BONUS
8-GALLON OIL DRAIN
\$99.99 Value



SHOP EQUIPMENT

8-GAL OIL DRAIN
SKU 186458
DAN122829 **99⁹⁹**

- 8-Gal Capacity
- Adjustable Height: 48"-67"
- Wide Drain Pipe for Draining Oil Quickly
- Large Funnel mouth to Catch Oil & Reduce Spillage



20-GAL OIL DRAIN
SKU 343408
DAN122835 **319⁹⁹**

- 20-Gal Capacity
- 15" Drainage Funnel
- Includes Regulator and Gauge



TRIPOD JACK STAND
SKU 186457
DAN105430 **129⁹⁹**

- 2 Ton Capacity
- Extra Tall & Stable
- Min Height : 68.7"
- Max Height: 76.7"



TELESCOPING 2-STAGE TRANSMISSION JACK
SKU 186451
DAN105452 **479⁹⁹**

- First Stage: 1,000-lbs
- Second Stage: 500-lbs
- Heavy-Duty Steel Swivel Casters
- Min: 34" - Max: 71"



50' HOSE REEL
SKU 343407
DAN116911 **199⁹⁹**

- 50' of 3/8" of Rubber Hose
- Working Pressure: 250psi
- Max CFM: 25
- 4 Way Non-Snag Rollers



ALIGNMENT LIFT

D-12/A
SKU 579870
DAN1375682 **4,399⁹⁹**

- Lifting Capacity: 12,000-Lbs.
- Alignment Ready
- Turn Plates & Slip Plates Included



Price Does Not Include Installation or Optional Equipment as Shown

BONUS
AIR-ELEC WORKSTATION
\$219.99 Value



LIFT ACCESSORIES

FRAME CRADLE PAD
SKU 289999
DAN119527 **49⁹⁹**

- For 2-Post Lifts
- Sturdy Steel Construction
- Tactile Rubber Mat



LIFT PAD ASSY ROUND
SKU 079518
DAN17107036 **49⁹⁹**

- Works with Dannmar 2-Post Lift
- Thick Rubber Construction
- Easy Drop-In Design
- 5" Diameter



RND SLIP OVER PAD
SKU 752032
DAN17108252 **22⁹⁹**

- Resistant to Gouging
- Abrasion Resistant
- Tear Resistant
- Sold Individually



TURNPLATES
SKU 751634
DAN135501 **359⁹⁹**

- 14" x 13.5" x 2"
- Smooth Bearings
- Sturdy Construction
- Sold Individually



AIR-ELEC WORK STATION
SKU 751635
DAN17350013 **239⁹⁹**

- Works with Any Lift
- 4 110v GFI Outlets
- Oiler, Air Supply, PSI Gauge, Storage Hooks for Hose and Tools, Air Inlet



DRIP TRAYS
SKU 186439
DAN101001 **69⁹⁹**

- Works with Dannmar D7 Series Lifts
- Set of 3
- Intended for Oil & Water-Based Fluids



ALIGNMENT COMBOS

SAVE OVER \$500

geoliner® 550 Aligner Combo with 9,000 Lbs. Lift

SKU OUTSIDE BUY/EPO ALIGNCOMB08 **18,299⁹⁹**

- This Combo Package Puts You in the Alignment Business with High Quality Hofmann® and Bendpak Products at a Great Low Price
- The HD-9AE Four Post Alignment Lift Provides 9,000 Lbs. of Lifting Capacity to Accommodate a Variety of Light Duty Trucks and Automobiles, and the Hofmann geoliner 550 Combines Advanced Technology and Affordability to Take Your Alignment Business to the Next Level
- This Kit Includes 2 RJ-45 Rolling Jacks and an Airline Kit
- Hofmann Aligner Includes Setup and Training

ALIGNCOMB08		\$18,299.99
BENHD-9AE	9,000 Lbs. Alignment Lift	\$4,049.99
HOFEWA717B	550 Aligner System	\$12,159.99
BENRJ-45	4,500 Lbs. Rolling Bridge Jack	\$1,194.99
BENRJ-45	4,500 Lbs. Rolling Bridge Jack	\$1,194.99
BEN5174009	Airline Kit Hd-9 Hd-14	\$249.99
TOTALS		\$18,849.95
SAVINGS		\$549.96

Available via Outside Buy/EPO, Call 1-877-298-6651 for ordering instructions.

Lift Gate Service SKU 290017 HOFLIFTGATE **95⁰⁰**



SAVE OVER \$900

geoliner® 550 Aligner Combo with 14,000 Lbs. Lift

SKU OUTSIDE BUY/EPO ALIGNCOMB02 **19,999⁹⁹**

- We've Combined the geoliner 550 Wireless Aligner with BendPak's HDS-14LSX Lift to Bring You Both Quality and Performance. The Hofmann® geoliner 550 Features an Easy-to-Use Interface That Guides the Technician Through the Alignment Process and Completes a Fast and Efficient Rolling Compensation without Jacking the Vehicle. The HDS-14LSX Pulls Double Duty as Both a Legendary 14,000 Lbs. Capacity Lift and an Alignment System.
- Combo Includes: Aligner, Lift, 2 Rolling Jacks and Airline Kit
- Hofmann Aligner Includes Set-Up and Training

ALIGNCOMB02		\$19,999.99
BENHDS14LSX	14,000 Alignment Lift	\$5,899.99
HOFEWA717B	550 Aligner System	\$12,159.99
BENRJ-7	7,000 Lbs. Rolling Jack	\$1,319.99
BENRJ-7	7,000 Lbs. Rolling Jack	\$1,319.99
BEN5174009	Airline Kit HD-9 HD-14	\$249.99
TOTALS		\$20,949.95
SAVINGS		\$949.96

Available via Outside Buy/EPO, Call 1-877-298-6651 for ordering instructions.

Lift Gate Service SKU 290017 HOFLIFTGATE **95⁰⁰**



SAVE OVER \$1,300

geoliner® 650 Aligner Combo with 14,000 Lbs. Extended Length Lift

SKU OUTSIDE BUY/EPO ALIGNCOMB03 **28,999⁹⁹**

- The Latest Imaging Technology from Hofmann® geoliner 650 Combined with BendPak's Legendary HDS14LSXE Makes for a Package That Delivers Beyond Your Expectations in Performance at a Price Much Less Than Expected. The geoliner 650 Features Set-Up to Readings in Under 2 Minutes.
- Combo Includes: Aligner, Extended Lift, 2 Rolling Jacks and Airline Kit
- Hofmann Aligner Includes Set-Up and Training

ALIGNCOMB03		\$28,999.99
BENHDS14LSXE	14,000 Alignment Lift Extended	\$6,499.99
HOFEWA712AL	650 Aligner System	\$20,999.99
BENRJ-7	7,000 Lbs. Rolling Jack	\$1,319.99
BENRJ-7	7,000 Lbs. Rolling Jack	\$1,319.99
BEN5174009	Airline Kit HD-9 HD-14	\$249.99
TOTALS		\$30,389.95
SAVINGS		\$1,389.96

Available via Outside Buy/EPO, Call 1-877-298-6651 for ordering instructions.

Lift Gate Service SKU 290017 HOFLIFTGATE **95⁰⁰**



SAVE OVER \$900

geoliner® 670 XD Aligner Combo with 14,000 Lbs. Lift

SKU OUTSIDE BUY/EPO ALIGNCOMB05 **30,599⁹⁹**

- Combining the 670 XD Imaging Wheel Alignment System Along with the Forward CRA14 14,000 Lbs. 4 Post Alignment Lift Gets You Both the Latest Technology and Proven Durability. The geoliner 670 XD Aligner Provides Patented Imaging Technology Along with Accurate and Real-Time Measurements While the Forward CRA14 14,000 Lbs. Alignment Lift with Concealed Cable and Pulley System and Multi-Position Lock Works as Both an Alignment and General Service Lift.
- Includes: Aligner, Steering Wheel Holder, Ride Height Target Kit, Brake Pedal Depressor, Remote Control, Color Inkjet Printer and Two Wheel Chocks, Alignment Lift, FLR (Filter, Lubricator, Regulator), (2) 7,000 Lbs. Capacity Rolling Jacks, Carbon Steel Front Radius Plates
- Hofmann® Aligner Includes Set-Up and Training

ALIGNCOMB05		\$30,599.99
FORCRA14COMBO	Forward Lift 14,000 Lb. 4 Post Alignment Lift	\$10,499.99
HOFEWA715H	Geoliner 670XD	\$21,069.99
FORRRJ70G	7,000 Lbs. Rolling Jacks (Set of Two)	INCLUDED
	Airline Kit	INCLUDED
	Turn Plates	INCLUDED
TOTALS		\$31,569.98
SAVINGS		\$969.99

Available via Outside Buy/EPO, Call 1-877-298-6651 for ordering instructions.

Lift Gate Service SKU 290017 HOFLIFTGATE **95⁰⁰**



SAVE OVER \$2,600

geoliner® 670 XD Aligner Combo with 12,000 Lbs. Scissor Alignment Lift

SKU OUTSIDE BUY/EPO ALIGNCOMB04 **34,499⁹⁹**

- The geoliner 670 XD Imaging Wheel Alignment System is One of the Most Advanced Alignment Systems on the Market Today. Combine This with the Revolutionary Quatra™ Pantograph Lift from Bendpak and You Have the Ultimate Alignment Combo.
- Combo Includes: Aligner, Lift, 2 Rolling Jacks and Airline Kit
- Hofmann® Aligner Includes Set-up and Training

ALIGNCOMB04		\$34,499.99
BENXR12000A	Quatra 12,000 Lbs. Capacity, Scissors Wheel Alignment Lift	\$13,249.99
HOFEWA715H	Geoliner 670XD	\$21,069.99
BENRJ-6	6,000 Lbs. Rolling Bridge Jack	\$1,299.99
BENRJ-6	6,000 Lbs. Rolling Bridge Jack	\$1,299.99
BEN5174009	Airline Kit HD-9 HD-14	\$249.99
TOTALS		\$37,169.95
SAVINGS		\$2,669.96

Available via Outside Buy/EPO, Call 1-877-298-6651 for ordering instructions.

Lift Gate Service SKU 290017 HOFLIFTGATE **95⁰⁰**



SAVE OVER \$1,600

Hofmann® Alignment Package Combo 650 Aligner with 12,000 Lbs. Scissor Lift

SKU OUTSIDE BUY/EPO HOFCOMB01 **37,999⁹⁹**

- Purchasing a Hofmann Aligner and Alignment Lift Combo Will Not Only Save You Money, it Will Provide the Assurance of Having Components That are Designed to Work Together. A Hofmann Rep Will Train You and Your Employees in the Safest, Most Profitable Way to Use Your New Equipment. Hofmann Aligners Provide the Most Advanced Alignment Systems on the Market. The Matching 12,000 Scissor Lift Maintains Constant Level Throughout the Lifting Range and Takes Up Less Space Than a Four Post.
- Includes: HOFEWA712AL 650 Imaging System Pro32 Aligner with AC200 Clamps HOFEELR709A 12,000 Lbs. Scissor Lift with (2) 6,000 Lbs. Rolling Jacks, Airline Kit, Turn Plates and Roll Back Kit

HOFCOMB01		\$37,999.99
HOFEELR709A	Hofmann 12,000 Lbs. Scissor Alignment Lift	\$17,499.99
HOFEWA712AL	Hofmann geoliner™ 650 Imaging Wheel Aligner	\$20,999.99
HOFEAK0289J06	Premium Turn Plates (Set of Two)	\$1,179.99
TOTALS		\$39,679.97
SAVINGS		\$1,679.98

BONUS Value: **\$69.99**

Roll Back Kit HOFEAK0277J28A

With Purchase of: HOFCOMB01 SKU 818791 | Part# HOFCOMB1
Offer Good Through June 30, 2017 - While Supplies Last



Available via Outside Buy/EPO, Call 1-877-298-6651 for ordering instructions.

ALIGNMENT

Alignment Lifts

9,000 Lbs. 4 Post Alignment Lift

SKU 396661
BENHD-9AE **4,049⁹⁹**

- Designed to Accommodate a Variety of Light-Duty Trucks and Automobiles
- Features Adjustable Multi-Position Leveling, Integrated Front Radius Plates and Rear Slip Plates



Optional:
RJ-45 Rolling Bridge Jack
SKU 898534 | BENRJ-45 **1,194⁹⁹**
Air Line Kit
SKU 531175 | BEN5174009 **249⁹⁹**



Price Does Not Include Vehicles, Installation or Optional Equipment as Shown

CALL TO ORDER

1-877-AZTool1 (1-877-298-6651)

14,000 Lbs. 4 Post Extended Alignment Lift

SKU 898468
BENHDS14LSXE **6,499⁹⁹**

- Features Extended Runways to Accommodate a Wide Variety of Vehicle Wheelbases
- Integrated Industrial Strength Slip Plates and Turn Plates to Maximize Alignment Convenience



Optional:
RJ-7 Rolling Bridge Jack
SKU 212556 | BENRJ-7 **1,319⁹⁹**
Air Line Kit
SKU 531175 | BEN5174009 **249⁹⁹**



Price Does Not Include Vehicles, Installation or Optional Equipment as Shown

14,000 Lbs. 4 Post Alignment Lift

SKU 898467
BENHDS14LSX **5,899⁹⁹**

- Adjustable Leveling, Integrated Front Radius Plates and Rear Slip Plates Makes Them Alignment Ready
- Compatible with All Leading Alignment Instrumentation, Including 3D and Camera Wheel Alignment Systems

Optional:
RJ-7 Rolling Bridge Jack
SKU 212556 | BENRJ-7 **1,319⁹⁹**
Air Line Kit
SKU 531175 | BEN5174009 **249⁹⁹**



BendPak
REAR SLIP PLATES, FRONT RADIUS PLATES



Price Does Not Include Vehicles, Installation or Optional Equipment as Shown

18,000 Lbs. Heavy Duty 4 Post Alignment Lift

SKU OUTSIDE BUY/EPO
BENHDS-18EA **14,699⁹⁹**

- Multi Caster Slip Plates in the Back and Turn Plates in the Front Allow for Extremely Precise, Free Floating Alignment
- Overall Width: 154" / 3912 mm
- Overall Length: 297" / 7544 mm
- Height of Columns: 93" / 2362 mm

Available via Outside Buy/EPO, Call 1-877-298-6651 for ordering instructions.



Price Does Not Include Installation or Optional Equipment as Shown

Quatra™ 12,000 Lbs. Scissors Wheel Alignment Lift

SKU OUTSIDE BUY/EPO
BENXR12000A **13,249⁹⁹**

- Features a More Compact Footprint to Better Utilize Smaller Service Bays
- Accommodates a Variety of Wheelbases from Short Compacts to Extended Length Pick-Ups and Work Trucks
- Includes Recessed Front Radius Plates and Oversized Rear Slip Plates

Optional:
RJ-6 Rolling Bridge Jack
SKU 210381 | BENRJ-6 **1,299⁹⁹**
Air Line Kit
SKU 531175 | BEN5174009 **249⁹⁹**



Price Does Not Include Installation or Optional Equipment as Shown



Available via Outside Buy/EPO, Call 1-877-298-6651 for ordering instructions.

Prices Do Not Include Vehicle, Installation or Optional Equipment as Shown.

Lead Times Can Vary on Alignment Equipment. Call 1-877-AZTool1 for Questions on Specifications, Availability and Lead Times.

15,000 Lbs. 4 Post Alignment Lift Package

SKU OUTSIDE BUY/EPO
CHLAR4015EAX **15,999⁹⁹**

- Package Includes:
- (2) 7,500 Lbs. Rolling Jacks
 - Internal Airline Kit
 - Stainless Steel Radius Gauges
 - Dual Rear Slip Plates
 - 20" Runway Width

CL Challenger Lifts



Includes Two Rolling Jacks

Price Does Not Include Installation or Optional Equipment as Shown

Available via Outside Buy/EPO, Call 1-877-298-6651 for ordering instructions.

18,000 Lbs. Heavy Duty Alignment 4 Post Package with 22" Wide Runways

SKU OUTSIDE BUY/EPO
CHLAR44018AR **18,999⁹⁹**

- Package Includes:
- (2) 9,000 Lbs. Rolling Jacks
 - Internal Air Line Kit
 - Stainless Steel Radius Gauges
 - Dual Rear Slip Plates
 - Heavy Duty Chain Drive and Sealed Roller Bearings



Includes Two Rolling Jacks

Price Does Not Include Installation or Optional Equipment as Shown

14,000 Lbs. 4 Post Open Front Wheel Alignment Lift

SKU OUTSIDE BUY/EPO
ROTAR014-EL2 **18,999⁹⁹**

- Compatible with New Technology Alignment Systems
- Includes: (2) Stainless Steel Radius Gauges, (2) 7,000 Lb. Capacity Rolling Jacks, 4WS Rear Slip Plates, Air Actuated Locking Latches, Portable Work Step and Internal Air Line Kit
- Level at All Locking Heights

Includes Two Rolling Jacks

Price Does Not Include Vehicles, Installation or Optional Equipment as Shown



Available via Outside Buy/EPO, Call 1-877-298-6651 for ordering instructions.

D-12/A™ 12,000 Lbs. Alignment Lift

SKU 579870
DAN1375682 **4,399⁹⁹**

- Compatible with All Leading Alignment Instrumentation, Including 3D and Camera Wheel Alignment Systems
- Multi Caster Slip Plates in the Rear Provide Precise Free Floating Movement
- Multiple Radius Plate Locations
- Radius Plates Included

Optional:
BK Rolling Jack
SKU 343411 | DAN1375901 **999⁹⁹**
Airline Kit Not Include



CALL TO ORDER

1-877-AZTool1 (1-877-298-6651)

14,000 Lbs. 4 Post Alignment Lift

SKU OUTSIDE BUY/EPO
FORCRA14 **10,499⁹⁹**

- Max Wheelbase: 182-1/2"
- Four Wheel Alignment: 89-1/4" to 156-3/4"
- Durable Cable and Sheave System
- Includes: (2) 7,000 Lbs. Capacity Rolling Jacks, Carbon Steel Front Radius Plates

Includes Two Rolling Jacks

FORWARD



Price Does Not Include Vehicles, Installation or Optional Equipment as Shown

Available via Outside Buy/EPO, Call 1-877-298-6651 for ordering instructions.

18,000 Lbs. 4 Post Alignment Lift

SKU OUTSIDE BUY/EPO
FORCRA18 **17,999⁹⁹**

- Max. Wheelbase: 194"
- Four Wheel Alignment: 63" to 162"
- Includes (2) Rolling Jacks, (2) Radius Plates and Internal Airline Kit

Includes Two Rolling Jacks

Prices Do Not Include Vehicle, Installation or Optional Equipment as Shown.

Lead Times Can Vary on Alignment Equipment. Call 1-877-AZTool1 for Questions on Specifications, Availability and Lead Times.

12,000 Lbs. Scissor Alignment Lift

SKU OUTSIDE BUY/EPO
HOFEELR709A **17,499⁹⁹**

- Overall Width: 90"
- Overall Length: 267-3/8"
- Width Between Runways: 40"
- Four Wheel Alignment Wheelbase: 89" to 158"
- Two Wheel Alignment Wheelbase: Up to 165"
- Service Wheelbase: 179"
- Runway Surface Width: 23"
- Maximum Raised Height: 70" (178 cm)
- Includes (2) Rolling Jacks

Includes Two Rolling Jacks



*Turn Plates Not Included

Price Does Not Include Installation or Optional Equipment as Shown



Includes Air Line Kit and Two 6,000 Lbs. Rolling Jacks



CALL TO ORDER
1-877-AZTool1 (1-877-298-6651)

Premium Turn Plates (Set of Two)
SKU 467503
HOFEAK0289J06 **1,179⁹⁹**

- Dimensions: 18.5" (L) x 19.7" (W) x 2" (H)

Prices Do Not Include Vehicle, Installation or Optional Equipment as Shown.

Lead Times Can Vary on Alignment Equipment. Call 1-877-AZTool1 for Questions on Specifications, Availability and Lead Times.

14,000 Lbs. 4 Post Open Front Alignment Lift

SKU OUTSIDE BUY/EPO
HOFEELR705A **18,499⁹⁹**

- Industry Leading 90" Long Rear Slip Plates to Accommodate Shorter and Longer Vehicles
- Includes: Filter/Regulator, Air Line Kit, (2) 7,000 Lbs. Rolling Jacks

Includes Two Rolling Jacks



Price Does Not Include Installation or Optional Equipment as Shown

*Turn Plates Not Included

Available via Outside Buy/EPO, Call 1-877-298-6651 for ordering instructions.

Free Delivery!
in 48 Continental United States

Specifications Subject to Change without Notice or Liability.
Prices Do Not Include Vehicles, Installation or Optional Equipment as Shown.

Customers Responsible for Offloading Equipment Upon Arrival.
Ask Your Sales Rep for Details.

Leasing Terms Available.*
Ask Your AutoZone® Commercial Sales Manager.

Leasing Terms Available!†

Ask Your AutoZone®
Commercial Sales Manager

AutoZone®
Tool & Equipment QUARTERLY

Alignment Systems

geoliner® 550 Portable Imaging Wheel Aligner

SKU OUTSIDE BUY/EPO 12,159⁹⁹
HOFEWA717B

- Easy to Use Interface Guides the Technician Through the Alignment Process
- Bluetooth® Communication to Sensors for True Mobility
- OEM Instructions Guide the Technician Through the Process of Resetting the Steering Angle Sensors
- Personalized Reports Showing Readings Before and After Service
- Detailed Videos of How to Make Needed Adjustments to Complete Even the Most Complex Tasks

Set-Up and Training Included!



CALL TO ORDER

1-877-AZTool1 (1-877-298-6651)

Lift Gate Service

SKU 290017 HOFLIFTGATE 95⁰⁰

650 Imaging Aligner System with Multi-Level Camera Boom

SKU OUTSIDE BUY/EPO 20,999⁹⁹
HOFEWA712AL

- Set-Up to Readings in Under 2 Minutes
- High-Definition Imaging Cameras Allow for System Installation within a Smaller Shop Bay
- Patented VODI™ Graphic Display
- EZ-Link* Steering Angle Sensor Reset
- 2 Wheel Alignment Capability
- 24" Universal Wheel Clamps

HOFMANN



Set-Up and Training Included!

Available via Outside Buy/EPO, Call 1-877-298-6651 for ordering instructions.

CALL TO ORDER

1-877-AZTool1 (1-877-298-6651)

Lift Gate Service

SKU 290017 HOFLIFTGATE 95⁰⁰

geoliner® 670 XD Wheel Aligner with Multi-Level Camera Boom

SKU OUTSIDE BUY/EPO 21,069⁹⁹
HOFEWA715H

One of the Most Advanced Alignment Systems on the Market Today

- Patented Imaging Technology Provides Accurate and Real-Time Measurements
- Smallest and Lightest Targets We've Ever Made
- Cross-Diagonal Measurements Identify Frame or Structural Damage
- AC400 Clamps with XD Targets
- Measures Right Height and Obtains Proper Alignment Specifications
- Step-by-Step Instructions as a Guide for Completing Even the Most Complex Tasks
- Extensive OEM Specifications Allow Quick and Accurate Vehicle Selection

CALL TO ORDER

1-877-AZTool1 (1-877-298-6651)

Set-Up and Training Included!



Lift Gate Service

SKU 290017 HOFLIFTGATE 95⁰⁰

Available via Outside Buy/EPO, Call 1-877-298-6651 for ordering instructions.

geoliner® 770 Diagnostic Wheel Alignment System with AC400 Wheel Clamps and XD Targets

SKU OUTSIDE BUY/EPO 29,199⁹⁹
HOFEWA752B

- Ideal For High-Volume Shops That Specialize in Alignments
- Compact Footprint, Designed to Fit Where You Need It
- Wireless Communication: Navigate, Monitor and Control the Unit from Anywhere in the Shop
- Includes: Steering Wheel Holder, (2) Wheel Chocks, Brake Pedal Depressor, 24" Flat Panel Monitor, Color Inkjet Printer, AC400 Wheel Clamps with XD Targets
- Wireless Cameras
- AC400 Touchless Wheel Clamps

Set-Up and Training Included!



CALL TO ORDER

1-877-AZTool1 (1-877-298-6651)

Lift Gate Service

SKU 290017 HOFLIFTGATE 95⁰⁰

Available via Outside Buy/EPO, Call 1-877-298-6651 for ordering instructions.

Alignment Accessories



QSP

The Perfect Choice for Those Smaller Shops Who Want the Advantages of a 4 Post Lift But Have Limited Floor Space
QSP Wheel Stands Can Be Leveled and Used for Wheel Alignment, Transforming Your 2 Post Lift Into a 4 Post Alignment Lift

24" Alignment Wheel Stands with Turn Plates and Slip Plates (Set of 4)

SKU 463769 2,199⁹⁹
QSPDB-24MD

- Turn Plates and Slip Plates Built Right Into the Stands
- Four Adjustable Legs to Level the Four Stands Together
- 2,500 Lbs. Capacity Per Plate



We Offer a Full Line of QSP USA-Made Products. Call 1-877-AZTool1 for Price, Specifications and Availability.



QSP

Add a Rear Slip Plate and Your Choice of Turn Plates to Convert Your Regular 4 Post 12,000/25,000 Lift Into an Alignment Lift

Rear Slip Plate Add-On Kit

SKU 463777 2,299⁹⁹
QSPDB-6000

- (2) 59-1/2" x 20" Full Floating Rear Slip Plates
- Simple Installation on Most General Service Lifts
- Length Options: 200" to 205", 186" to 196" and 173"
- Turn Plates Not Included



Steering Wheel Holder and Pedal Depressor Kit

SKU 802195 64⁹⁹
24231

- Holds Steering Wheel in Position for Alignment Adjustments
- Depresses Brake Pedal for Various Brake Checks Including Brake Lamp Operation
- Simply Hand Squeeze the Actuator to Accomplish Fine Adjustments



Alignment Turn Plate (Pair)

SKU 751634 359⁹⁹
DAN135501

- Each Turn Plate is Equipped with Roller Bearings for 'Full-Floating' Movement to Assure Easy Front - Wheel Positioning for Accurate Caster and Steering
- Sold in Sets of 2
- Dimensions: 14" x 13.5" x 2"



Dannmar
EQUIPMENT

Steel Turn Plates with Handle (Pair)

SKU 463771 549⁹⁹
QSP25-140

- Capacity: 4,500 Lbs. per Plate
- Features Dynamic Load Control
- Dimensions: 14" x 14" x 1.5"



QSP
Made in USA

Stainless Steel Turn Plates without Pointer (Pair)

SKU 463808 949⁹⁹
QSP25-129

- Capacity: 4,500 Lbs. per Plate
- Dimensions: 14" x 14" x 1.5"
- Fits Most Standard Alignment Racks



QSP
Made in USA



Approved Outside Buy Vendor



ISN Tools Presents
ATLAS
Automotive Equipment

ISN/Atlas Dedicated Sales
Toll Free **877-866-5739**

Atlas Dedicated Tech Support
Toll Free **800-787-8213**

TWO POST LIFTS

APEX 10

10,000 LB Capacity
Overhead Lift

ATTD-APEX10

2,495⁹⁹

INCLUDES
SHIPPING

- Adjustable Height
- Single Point Lock Release
- High Quality Powder Coating
- Professional Grade Arm Lock Restraint System
- Special "Double S" Bends Increases Column Strength



Price Does Not Include Vehicles, Installation or Optional Equipment as Shown



Apex 10 Specifications*

Capacity	10,000 LB.
Overall Height	11' 7 7/8"
Overall Height w/ Cylinder	12' 4"
Overall Width	11' 5 1/2" (Symtrc.)
Shut-Off Height	11' 2 1/4"
Maximum Lift Height	6' 1/2"
Rear Arm Length	35" - 58"
Front Arm Length	22" - 43 1/2"
Between Columns	9' 4 1/2" (Symtrc.)
Drive Through	8' 4" (Symtrc.)
Minimum Arm Height	4 1/2"

*Measurements based on highest adjustable height



Price Does Not Include Vehicles, Installation or Optional Equipment as Shown

APEX 9BP

9,000 LB Capacity
Baseplate Lift

ATTD-APEX9BP

2,495⁹⁹

INCLUDES
SHIPPING

- Overall Height: 9' 3 1/2"
- Overall Floor Width: 11' 6 1/2"
- Clearance Between Columns: 9' 3 1/2"
- Maximum Lift Height: 6' 2 1/2"



Price Does Not Include Installation or Optional Equipment as Shown



APEX 12

12,000 LB Capacity
Overhead Lift

ATTD-APEX12

3,495⁹⁹

INCLUDES
SHIPPING

- Overall Height: 14' 9"
- Overall Floor Width: 12' 6 1/2"
- Clearance Between Columns: 10' 2 2/3"
- Maximum Lift Height: 6' 1 3/4"



Price Does Not Include Installation or Optional Equipment as Shown



APEX 15

15,000 LB Capacity
Overhead Lift

ATTD-APEX15

4,995⁹⁹

INCLUDES
SHIPPING

- Overall Height: 16' 6 1/2"
- Overall Floor Width: 12' 3"
- Clearance Between Columns: 8' 9 1/8"
- Maximum Lift Height: 6' 3/8"



Price Does Not Include Installation or Optional Equipment as Shown



FOUR POST LIFTS

APEX 8

8,000 LB Capacity
Hobbyist Lift

ATTD-APEX8

2,495⁹⁹

INCLUDES
SHIPPING

- Overall Height: 7' 3 1/2"
- Overall Floor Width: 8' 8 1/4"
- Runway Length: 13' 9 1/2"
- Runway Width: 1' 6 3/4"
- Maximum Raised Height: 6'
- Minimum Lowered Height: 4 1/2"



Price Does Not Include Installation or Optional Equipment as Shown



APEX 14

14,000 LB Capacity
Commercial Grade Lift

ATTD-APEX14

3,995⁹⁹

INCLUDES
SHIPPING

- Overall Height: 7' 8 1/2"
- Overall Floor Width: 10' 11 2/3"
- Runway Length: 17' 1 1/2"
- Runway Width: 1' 8 1/8"
- Maximum Raised Height: 6' 6 3/8"
- Minimum Lowered Height: 7' 7/8"



Price Does Not Include Installation or Optional Equipment as Shown



SCISSOR LIFTS

LR-06P

6,000 LB Capacity
Low Rise Lift

ATPK-LR06

1,545⁹⁹

INCLUDES
SHIPPING

PERFECT FOR
WHEEL SERVICE



Maximum Lift Height: 2' 1 1/2"

Price Does Not Include Vehicles, Installation or Optional Equipment as Shown

TD6MR

6,000 LB Capacity
Mid Rise Lift

ATTD-6MR

1,745⁹⁹

INCLUDES
SHIPPING



Maximum Lift Height: 4' 5 1/2"

Price Does Not Include Vehicles, Installation or Optional Equipment as Shown

SLP-9K

9,000 LB Capacity
Full Rise Lift

ATTD-SLP9K

4,545⁹⁹

INCLUDES
SHIPPING

- Maximum Lift Height: 6' 6"
- Max Overall Width: 6' 10 1/2"
- Overall Length: 6' 10"



Price Does Not Include Vehicles, Installation or Optional Equipment as Shown

WHEEL SERVICE

WB-11

Self-Calibrating
Wheel Balancer

ATWB11

- Static And Dynamic Balancing Modes
- Rapid Optimization (OPT)
- Automatic Positioning Where To Apply Weights
- Automatic Start/Stop When Hood Is Lowered/Raised



1,345⁹⁹

INCLUDES
SHIPPING

Price Does Not Include Tires or Rims as Shown

TC229

Wheel Clamp Tire Changer
With Bead Blaster

ATTC229

- Max Tire Diameter: 39"
- Max Wheel Width: 13"
- Inner Clamp: 11 5/8" - 25 1/4"
- Outer Clamp: 9 3/4" - 23 1/4"

1,545⁹⁹

INCLUDES
SHIPPING

Price Does Not Include Tires or Rims as Shown



EDGE 501

Wireless 8 Camera
Alignment Machine
With 4 Point Clamps

ATEDGE-501-4PT

10,145⁹⁹

INCLUDES
SHIPPING



Price Does Not Include Installation or Optional Equipment as Shown

Leasing Terms Available!†

Ask Your AutoZone®
Commercial Sales Manager

PURCHASING PROGRAMS



Ask Us About Our Tool and Equipment Purchase Programs



**OPTION 1
LEASING COMPANY**

Leases are Handled by Three Companies

LCA LEASE CORPORATION OF AMERICA
Financing you can trust.™



UniSource Capital
Never give up...Never Surrender!®

Customer Must:

- Select Equipment
- Complete Credit Application
- Receive Approval From Leasing Company

Once the Transaction is Approved

- PO Issued
- Tool Ordered



**OPTION 2
30-60-90**

✓ AutoZone® Credit Account in Existence for 6 Months

✓ Updated Credit Application with Agreement Section Completed and Signed

✓ No NSF Checks

✓ No Credit Holds 6 Months

✓ Credit Worthiness

✓ Minimum Equipment Cost
• \$1K (Tax Must Be Included)

✓ 25% Minimum Down Payment

✓ 52 Week Sales Amount \$15K



**OPTION 3
EXTENDED TERMS**

✓ 3 Years in Business (Credit Bureau Reporting)

✓ Updated Credit Application with Agreement Section Completed and Signed

✓ No NSF Checks for 1 Year

✓ 1 Year Satisfactory Payment History with AutoZone®

✓ Credit Worthiness

✓ Minimum Equipment Cost by Term
• 6 Months \$3K
• 9 Months \$6K
• 12 Months \$8K or greater

✓ 25% Minimum Down Payment

✓ Financial Statement

✓ 52 Week Sales Amount \$25K

Financing is provided by third parties who are not affiliates of AutoZone. All of the advertised loan programs, rates, terms and conditions are subject to change at any time without notice. An extra charge may be imposed at the end of the lease depending on the residual value of the leased goods.

Available via Outside Buy/EPO,
Call 1-877-298-6651 for ordering instructions.

CEMB USA / BL systems Inc is the US based company of the Italian CEMB world leader in balancing equipment since 1946. Providing a full range of high quality MADE IN ITALY garage equipment with outstanding service and unbeatable value.



CEMB USA
BALANCING MACHINES



DWA3400-3D
Imaging aligner for cars and light trucks
• Movable camera boom
• Alignment specs history of 40+ years
• Simple and user-friendly software
• ON-SITE installation and training



DWA1000XL
8 sensor CCD technology aligner for cars and light trucks
Four shock resistant BT2 wireless rechargeable heads (only 5.75 lbs each)
• Long life lithium ion batteries
• Simple and user-friendly software
• ON-SITE installation and training



TOP
SELLER

ER72-TD
Digital wheel balancer for cars and light trucks. Professional wheel balancer designed for heavy duty.
• Automatic distance and diameter data entry with width sonar 3D (CEMB patent)
• LED to light work space inside
• Ergonomic design to grant better access to the wheel
• Full-time accuracy with STATIC unbalance always displayed
• OPB - One Plane Balancing
• Fully automatic SPOTTER laser system for best correction (no comebacks)

Price Does Not Include Tires or Rims as Shown

\$6.314⁹⁹ with PRESS-ARM \$7.249⁹⁹



ER73-TD
Video wheel balancer for cars and light trucks. Professional wheel balancer designed for heavy duty.
• Automatic distance and diameter data entry with width sonar 3D (CEMB patent)
• LED to light work space inside
• Ergonomic design to grant better access to the wheel
• Full-time accuracy with STATIC unbalance always displayed
• OPB - One Plane Balancing
• Fully automatic SPOTTER laser system for best correction (no comebacks)
AVAILABLE ALSO WITH PNEUMATIC LOCKING AND RUN-OUT SONAR (ER75TD)

Price Does Not Include Tires or Rims as Shown

TOP OF THE LINE



SM1120
Center post leverless tire changer for cars and light trucks.
• PARALLEL ARM with memory lock (patented)
• Double arm/disc air operated bead loosening unit (patented)
• Leverless mount/dismount system (patented)
• Power-Out System: Double-effect cylinder with spike limiter (patented)
• Wheel lift
• 2-Speed rotation by pedal
• Tire inflation by pedal

\$14.820⁹⁹

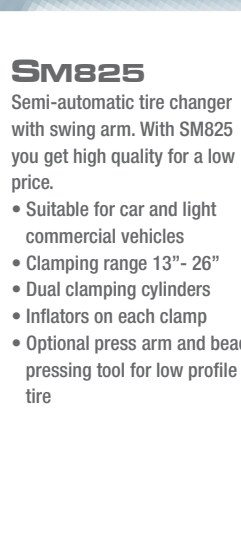

SM825
Semi-automatic tire changer with swing arm. With SM825 you get high quality for a low price.
• Suitable for car and light commercial vehicles
• Clamping range 13" - 26"
• Dual clamping cylinders
• Inflators on each clamp
• Optional press arm and bead pressing tool for low profile tire

\$3.149⁹⁹



Ez29
Portable hand spin wheel balancer for cars and light trucks. Ideal for low, mid as well high volume shops, thanks to the possibility of balancing wheels anywhere.
• Dual voltage power supply 12VDC/110VAC
• Automatic distance and diameter data entry 2D (CEMB patent)

BALANCE EVERYWHERE

Price Does Not Include Tires or Rims as Shown

\$2.849⁹⁹

JACKS AND HYDRAULICS

Floor Jacks

3 Ton Magic Lift™ Jack with 3 Ton Jack Stands

SKU 544584 **189⁹⁹**
OMG25033

- Jack Maximum Height: 20-7/8"
- Jack Minimum Height: 5-1/4"
- Jack Stands Maximum Height: 17"
- Jack Stands Minimum Height: 11-1/2"



The Banner 3-1/2 Ton Fast Lift Service Jack

SKU 344792 **199⁹⁹**
BHK6350

- Min. Height: 5-1/2"
- Max. Height: 22"



3-1/2 Ton Magic Lift™ Service Jack

SKU 964644 **249⁹⁹**
OMG27035

- Innovative Design of Magic Lift Offers a Quick Lift
- Max. Height: 23"
- Low Profile Design Allows for Easy Access to Lift Points



Hybrid Floor Jacks

Aluminum/Steel Hybrid Jack

- Combines Aluminum and Steel for a Lightweight, Strong Jack Frame
- Extra Wide Wheels for Increased Stability

1-1/2 Ton
SKU 847097 **229⁹⁹**
OMG26017

- Dual Piston Speedy Lift Lightweight Service Jack
- Minimum Height: 3.35", Maximum Height: 13.78"
- Gross Weight: 32.88 Lbs.



2-1/2 Ton
SKU 847099 **269⁹⁹**
OMG26028

- Single Piston Magic Lift™ Lightweight Service Jack
- Minimum Height: 3.86", Maximum Height: 18.62"
- Gross Weight: 57.27 Lbs.



3 Ton
SKU 847104 **329⁹⁹**
OMG26033

- Single Piston Magic Lift™ Lightweight Service Jack
- Minimum Height: 3.74", Maximum Height: 19.09"
- Gross Weight: 70.48 Lbs.



2 Ton Floor Jack

SKU 964622 **409⁹⁹**
HEIHW93642

- Min. Height: 4-1/2"
- Max. Height: 20-1/4"



3 Ton Floor Jack

SKU 964623 **534⁹⁹**
HEIHW93652

- Min. Height: 5"
- Max. Height: 23-1/2"



4 Ton Floor Jack

SKU 964624 **1,629⁹⁹**
HEIHW93657

- Min. Height: 5"
- Max. Height: 25-3/4"



Low Profile Floor Jacks

2 Ton Low Profile Service Jack

SKU 847093 **219⁹⁹**
OMG29021

- Dual Fast Action Pump Piston
- U-Joint Assembly for Precise Load Control
- Minimum Height: 3.13"
- Maximum Height: 19.88"
- Gross Weight: 70 Lbs.



2 Ton Low Profile Jack

SKU 964645 **274⁹⁹**
OMG29023

- For Low Profile Cars as Well as SUVs
- Extra Long Low Side Rails to Reach Hard to Get to Jack Points
- Low Height: Only 2.5"
- Max. Height: 20"



2-1/2 Ton Low Profile Magic Lift™ Jack

SKU 847105 **189⁹⁹**
OMG29028

- Foam Handle Cover
- U-Joint Assembly for Precise Load Control
- Minimum Height: 3.35"
- Maximum Height: 19.3"
- Gross Weight: 69.5 Lbs.



2-1/2 Ton Low Profile Service Jack

SKU 847094 **229⁹⁹**
OMG29027

- Dual Fast Pump Piston
- U-Joint Assembly for Precise Load Control
- Minimum Height: 2.9"
- Maximum Height: 20"
- Gross Weight: 71 Lbs.



2-1/2 Ton Low Profile Magic Lift™ Jack and 3 Ton Jack Stand Combo

SKU 847101 **219⁹⁹**
OMG25055

- Foam Handle Cover
- Jack - Minimum Height: 3.35", Maximum Height: 19.3"
- Stands - Minimum Height: 11.5", Maximum Height: 17"
- Gross Weight: 91 Lbs.



3 Ton Low Profile Magic Lift™ Jack

SKU 847106 **199⁹⁹**
OMG29031

- Foam Handle Cover
- U-Joint Assembly for Precise Load Control
- Minimum Height: 3.75"
- Maximum Height: 19.75"
- Gross Weight: 75.3 Lbs.



3 Ton Low Profile Service Jack

SKU 847096 **299⁹⁹**
OMG29033

- Dual Fast Action Pump Piston
- U-Joint Assembly for Precise Load Control
- Minimum Height: 3.54"
- Maximum Height: 19.75"
- Gross Weight: 75.3 Lbs.



3-1/2 Ton Low Profile Magic Lift™ Jack

SKU 847107 **219⁹⁹**
OMG29038

- Foam Handle Cover
- U-Joint Assembly for Precise Load Control
- Minimum Height: 4"
- Maximum Height: 21"
- Gross Weight: 83.7 Lbs.



Aluminum Floor Jacks

3 Ton Aluminum Jack
SKU 847102 **369⁹⁹**
OMG26030

- All Aluminum Structure Provides Strength and Stability
- Side Frame Handles Allow for Easy Carrying
- U-Joint Assembly for Precise Load Control
- Min. Height: 2.91", Max. Height: 20.12"
- Gross Weight: 44 Lbs.



Air Hydraulic Jacks

20 Ton Air Hydraulic Bottle Jack
SKU 544795 **109⁹⁹**
24850 REG. \$129.99

- Can Be Operated with Air or Manually
- Height: 10.25" - 20"
- Extension Screw Adjustment: 3.25"



Offer Good Through June 30, 2017 - While Supplies Last



SAVE \$20

20 Ton Air Actuated Bottle Jack

SKU 012650 **294⁹⁹**
OMG18204C

- Min. Height: 9-3/4"
- Max. Height: 18-3/4"
- Hydraulic Lifting: 5-1/8"
- Extension Screw Adjustment: 3-7/8"



22 Ton Air Hydraulic Truck Jack

SKU 544796 **399⁹⁹**
24851

- Compact, Low Profile Design Easily and Safely Fits Between Wheels of Tandem Axle Vehicles
- Min. Height: 8-1/2"
- Max. Height: 17-3/4"
- Ram Travel: 4-3/4"
- Extension Screw Adjustment: 4-1/2"



DID YOU KNOW?

AutoZone® has availability to over 14,000 unique part numbers for replacement engines and transmissions.

Contact Your AutoZone Commercial Sales Manager for Details

Leasing Terms Available!†

Ask Your AutoZone®
Commercial Sales Manager

AutoZone®
Tool & Equipment QUARTERLY

Jack Stands



3 Ton Jack Stand Set
SKU 222493
BHKBH5030
• Max. Height: 17"
44⁹⁹



3 Ton Ratcheting Jack Stand Set
SKU 964601
HEIHW93503
• Max. Height: 19"
• Ratchet Action Height Adjustment
94⁹⁹



6 Ton Magic Lift Jack Stand Set
SKU 964648
OMG32066
• Max. Height: 24-3/8"
79⁹⁹



6 Ton Ratcheting Jack Stand Set
SKU 964621
HEIHW93506
• Max. Height: 25-3/4"
• Ratchet Action Height Adjustment
134⁹⁹



22 Ton Truck Stand - Pin Style
SKU 964651
OMG32225
• Min. Height: 12-1/4"
• Max. Height: 19-7/8"
• Sturdy, Welded Steel Construction for Superior Safety and Strength
• Sold in Pairs and Used in Pairs
199⁹⁹

Under Hoist Stands



1,500 Lbs. High Reach Jack Stand
SKU 300796
BHKBH5710
• Min. Lift Height: 53-3/4"
• Max. Lift Height: 78-7/8"
• Base: 12" Diameter
119⁹⁹



3/4 Ton High Reach Jack Stand with Foot Pedal
SKU 300797
BHKBH5715
• Min. Lift Height: 53-3/4"
• Max. Lift Height: 78-7/8"
• Base: 12" Diameter
124⁹⁹



2 Ton High Tripod Jack Stands
SKU 901744
RANRJS2TH
144⁹⁹
• Perfect for Holding Drive Train or Exhaust Components in Position
• Capacity: 4000 Lbs.
• Low Height: 55"
• Max Height: 87"



2 Ton Tripod Auxiliary Stand
SKU 818750
OMG33020
149⁹⁹
• Heavy Gauge, Steel Frame Helps Prevent Distortion or Twisting
• Adjustable Height: 66-1/2" to 75-3/4"
• Base: 24" x 24" x 24"

Jack Accessory



Garage Floor Jack Crossbeam
SKU 544803
24833
• Compatible with Any Floor Jack That Has a 1-1/8" Diameter Saddle Stud
• Saddles Adjust from 23" to 32" on Center
• Weight Capacity at Min. - Max. Width: 3,000 Lbs. - 4,000 Lbs.
59⁹⁹

Transmission Jacks



1,100 Lbs. Telescopic Transmission Jack
SKU 544786
24840
• Lift Range: 51" - 70"
• Adjustable Saddle with Tilt in Both Directions
• Durable Steel Casters
• Safety Tie-Down Chain to Secure the Load
179⁹⁹
70" REACH



1,100 Lbs. High Lift Transmission Jack with Foot Pump
SKU 750006
24844
• Lift Range: 47" - 77"
• Adjustable Saddle with Tilt
• Spring-Loaded Release Valve Controls Lowering
• Durable Steel Casters
349⁹⁹
77" REACH



1/2 Ton Capacity Transmission Jack
SKU 902481
RANRTJ1100
• Lifting Capacity: 1,100 Lbs.
• Lowered Height: 45"
• Raised Height: 72"
379⁹⁹
72" REACH



700 Lbs. Transmission Jack
SKU 533215
BHKBH7000
• Lifting Capacity: 700 Lbs.
• Lowered Height: 57-1/4"
• Raised Height: 76-5/8"
• Double Pivoting Adjustable Saddle That Can Expand to Almost 19" x 19"
389⁹⁹
76-5/8" REACH

1 Ton, 2 Stage Telescopic Transmission Jack
SKU 544788
24842
• Lift Range: 33.5" - 72.5"
• 3 Way Adjustable Saddle Slides and Tilts Both Directions
• Convenient Foot Pedal Pump and Release
• Safety Anchor Chain Included
549⁹⁹ REG. \$599.99
72-1/2" REACH
SAVE \$50
Offer Good Through June 30, 2017 While Supplies Last



1 Ton Telescoping Transjak™
SKU 902478
RANRTJ1
• Capacity First Stage: 2,000 Lbs.
• Capacity Second Stage: 1,000 Lbs.
• Lowered Height: 37"
• Raised Height: 71"
689⁹⁹
71" REACH



1/2 Ton Telescoping Transmission Jack
SKU 964652
OMG41000C
• Lifting Capacity: 1,000 Lbs.
• Lowered Height: 37-3/4"
• Raised Height: 78-1/8"
744⁹⁹
78-1/8" REACH



1-1/2 Ton Telescoping Transmission Jack
SKU 902484
RANRTJ3000
• Capacity First Stage: 3,000 Lbs.
• Capacity Second Stage: 2,000 Lbs.
• Lowered Height: 35-1/2"
• Raised Height: 71-1/2"
749⁹⁹
71-1/2" REACH



1/2 Ton Air Actuated Telescopic Transmission Jack
SKU 222744
OMG41001C
• Air Turbo Motor is Air Equipped to Raise the Load to the Desired Height Efficiently, Effortlessly and Safely
• Chrome-Plated Rams Maximize its High Reach
• Operated By a User-Friendly Foot Pedal
• Max. Height: 78-1/8"
1,079⁹⁹
78-1/8" REACH



3/4 Ton Quick Lift Telescopic Transmission Jack
SKU 338731
BHKBP407
• Dual-Pedal Pump Design for Quick Lift Action and Fine Tuning
• Chrome Plated Ram for Long Life
• Maximum Height: 82.38", Minimum Height: 42.61", Base Dimensions: 33.07" x 35.55"
• User Selected Dual Pump Pistons
• High Cycle Durability
• Longer Saddle Supports
• Improved Bearing Surfaces
• High/Low Temp Functionality
• Conforms to ASME PALD/2009 Safety Standards
1,599⁹⁹

800 Lbs. Low Profile Transmission Jack
SKU 544789
24843
• Lift Range: 8-1/4" to 30-1/2"
• Fully Adjustable Saddle Adapts to Most Transmission Pans
• Swivel Saddle Adjusts Both Directions
• (4) Swivel Ball Bearing Casters for Ease of Mobility
299⁹⁹ REG. \$349.99
SAVE \$50
Offer Good Through June 30, 2017 While Supplies Last



1 Ton Floor Style Transmission Jack
SKU 964631
HEIHW93718
• Max. Height: 44-3/4"
• Designed for Heavy Duty Transmissions
2,284⁹⁹

Fuel Tank Adapter for Transmission Jacks
SKU 222503
DOWJDI-FTA7
• Safe and Convenient Adapter for Handling Vehicle Fuel Tanks
• Works with Most Transmission Jacks
189⁹⁹



The Professional Choice for Safe Fuel Tank Removal and Fuel Pump Service.
Mounts Easily on Most Transmission Jacks.



JACKS AND HYDRAULICS

Wheel Dollies



Vehicle Position Jack Storage Rack
 SKU 544800 **49⁹⁹** REG. \$59.99
 24856
 • Neatly Secure and Store Up to (4) Vehicle Car Dolly Jacks
 • Dimensions: 24-7/8" (L) x 31-7/8" (W) x 9-9/16" (H)
 • 5" x 1" 360 Degree Swivel Ball Bearing Wheels for Easy Maneuvering
 • Weight Capacity: 300 Lbs.

Offer Good Through June 30, 2017 While Supplies Last

BUY TWO JACKS FOR \$219.99

Two 1,500 Lbs. Vehicle Position Jacks

SKU 298098 **219⁹⁹**
 24855TWO
 • Hydraulic Ram Provides Stable Foot Pedal Lift in Seconds
 • Rolls in Any Direction



SAVE \$39.99 WHEN YOU BUY TWO

One 1,500 Lbs. Vehicle Position Jack

SKU 544798 **129⁹⁹**
 24855



OEM TOOLS

Vehicle Position Jacks with Storage Cradle

SKU 696485 **549⁹⁹**
 68986
 • Includes (4) Position Jacks with Storage Stand
 • Move Up to a 6,000 Lb. Vehicle with Ease
 • Adjusts 3.25"



2,000 Lb. Heavy Duty 3-in-1 Car Dolly Set

SKU 296929 **299⁹⁹**
 OMG47020
 • Holds Vehicle By: Wheel, Pinch Weld or Frame
 • Integrated Frame Adapters Eliminate Need for Additional Adapters
 • Locking Casters
 • Self-Stacking for Convenient Storage
 • Sold in Pairs



Truck Wheel Dolly

3/4 Ton Wheel Dolly
 SKU 291389 **559⁹⁹**
 OMG47053

- Safely Remove and Install Wheel Assemblies from HD Trucks
- Single, Duals/Tandems and Duplex Tires and Wheels
- Lift Arms Can Be Adjusted to Handle Different Wheel Combinations



Shop Presses

BONUS Shop Press Pin Set
 SKU 544794 | PART# 24813
Value: \$99.99

- Includes Set of (8) Press Pins, 2 to 20 Ton Capacity, with 25 mm Ram Adapter
- Suitable for Use with Hydraulic Ram Style Shop Presses Which Have a Female Ram Assembly Diameter of 25 mm and are Secured with a Bolt
- Includes Mountable Bracket
- Works with OEMTOOLS 24811 and 24812
- Not for Use with Bottle Jack Style Shop Presses



With Purchase of:
12 Ton Hydraulic Shop Press w/ Gauge
 SKU 544790 | Part# 24811
 OR
20 Ton Air/Hydraulic Shop Press w/ Gauge
 SKU 544793 | Part# 24812

12 Ton Hydraulic Shop Press with Gauge

SKU 544790 **349⁹⁹**
 24811

- Includes Press Blocks
- Oil Filled Pressure Gauge Provides Accurate Pressure Readings
- Measurement Between Uprights: 20"
- Working Range: 0" to 36-1/8"



20 Ton Air/Hydraulic Shop Press with Gauge

SKU 544793 **499⁹⁹**
 24812

- Includes Press Blocks
- Oil Filled Pressure Gauge Provides Accurate Pressure Readings
- Ram Moves Side to Side for Versatility
- Measurement Between Uprights: 21-1/8"
- Working Range: 0" to 40-1/2"



Offer Good Through June 30, 2017 - While Supplies Last

Shop Press

20 Ton Shop Press
 SKU 300134 **379⁹⁹**
 24810

- Includes Press Plates
- Remove and Install Bearings, Gears, U-Joints, Bushings, Ball Joints and Pulleys
- Multi-Position Bed for Work Height Adjustment
- Max. Height: 31.5"
- Max. Width: 21.75"

Super Heavy Duty H-Frame Press Weighs Over 250 Lbs. Providing More Strength and Durability Compared to Similar Lighter Weight Shop Presses on the Market



Bearing Separators

OEM TOOLS

Bearing Splitter, 1/4" to 15/16"

SKU 514005 **29⁹⁹**
 27231

- Maximum Spread: 15/16"
- Minimum Spread: 1/4"
- Thread of Tapped Holes in Adapter: 5/16" - 18
- Distance Between Adjusting Screws: 1-11/16"



Bearing Splitter, 1/2" to 4-5/8"

SKU 514006 **59⁹⁹**
 27232

- Razor Sharp Edges Wedge Between Parts and Securely Holds Tool
- Maximum Spread: 4-5/8"
- Minimum Spread: 1/2"
- Thread of Tapped Holes in Adapter: 5/8" - 18
- Distance Between Adjusting Screws: 4-3/8"



5 Ton Bar-Type Puller/Bearing Separator Set

SKU 347218 **79⁹⁹** REG. \$99.99
 27236

- Separator Tools are Used with Bar Puller and Legs for a Wide Variety of Pulling Jobs
- Set Includes: 2" and 3" Bearing Splitters, (4) Sets of Hex Push-Puller Legs and a Bar-Type Puller Head with a 9/16" Forcing Screw



SAVE \$20

Offer Good Through June 30, 2017 While Supplies Last

Engine Lifts

Duralast

2 Ton Capacity Engine Hoist

SKU 123037 **229⁹⁹**
 80-900T

- 8 Ton Capacity Hydraulic Jack for Faster and Easier Raising Action
- Large Diameter Ram to Withstand Side Loads
- 4 Position Telescoping Boom is Adjustable from 1/2 Ton to 2 Ton Capacity
- Legs are Over 55" Long for Greater Stability



2 Ton Folding Engine Crane

SKU 902288 **499⁹⁹**
 RANRSC2TF

- Heavy Duty Hydraulic Folding Engine Hoist with 8 Ton Capacity Ram is Perfect for Shops That Have Limited Space But Still Need the Pure Lifting Convenience of a Crane
- Front Casters Include a Safety Brake to Prevent Movement



OEM TOOLS

2 Ton Folding Shop Crane

SKU 544801 **399⁹⁹**
 24830

- Foldable Design Makes for Convenient, Easy Storage
- (6) Solid Steel Caster Wheels Add Mobility
- Fully Adjustable 4 Position Boom



OEM TOOLS

Engine Leveler

SKU 544802 **49⁹⁹**
 24831

- Great for Use with Engine Hoist or Engine Crane
- Makes Engine Handling and Positioning Easier
- Rated Capacity: 1600 Lbs.



Engine Stands

OEM TOOLS

1,250 Lbs. Engine Stand

SKU 462493 **129⁹⁹**
 24829

- Easy-to-Move and Rotate
- Heavy Gauge Square Steel Tube Frame
- Extra Wide 4 Wheel Base Provides Added Stability
- 360° Rotation
- Lock Pin Locks Engine into Position
- Includes Tool Tray



1,250 Lbs. Engine Stand

SKU 534418 **179⁹⁹**
 OMG31250

- Constructed from Heavy Gauge Welded Square Tubular Steel
- Extra Long Handle with Rubber Grips for Easy Rotation and Maneuvering



1 Ton Folding Engine Stand

SKU 544804 **199⁹⁹** REG. \$249.99
 24834

- Folds Upright to Conserve Valuable Floor Space
- Sturdy, Wide Base Design to Prevent Tipping Under Load
- Slotted Adjustable Saddle Permits Quick and Easy Installation
- Head Swivels 360° to Easily Position Engine



SAVE \$50

Offer Good Through June 30, 2017 While Supplies Last

1,250 Lbs. Rotating Engine Stand

SKU 964646 **339⁹⁹**
 OMG31256

- Extra Long Handle with Rubber Grip for Easy Rotation and Maneuvering
- Head Plate Locks in 8 Positions and Rotates 360°
- Heavy Duty Worm Gear Allows for Smooth and Effortless Engine Rotation



Leasing Terms Available!†

Ask Your AutoZone®
Commercial Sales Manager

AutoZone®
Tool & Equipment QUARTERLY

QuickJack™

5,000 Lbs. QuickJack™ Car Jack Support System

SKU 850896
RANBL5000SLXA (110V AC) **1,339⁹⁹**

- Complete Package Includes: (2) Jack Frame Assemblies, (2) 150" Hydraulic Hoses, (2) 14" Aux. Hoses, (2) Quick-Mount Handles, (4) 1.5" X 3" X 4" Rubber Lifting Blocks, (4) 3" X 3" X 4" Rubber Lifting Blocks, (1) Mini Hydraulic Power Unit with Pendant Control



Price Does Not Include Vehicles. Installation or Optional Equipment as Shown.

3,500 Lbs. QuickJack™
SKU 850894
RANBL3500SLXA (110V AC) **1,124⁹⁹**

QuickJack SUV and Light Truck Adapters Not Included

7,000 Lbs. QuickJack™
SKU 850897
RANBL7000SLXA (110V AC) **1,489⁹⁹**

QuickJack™ SUV and Light Truck Adapters

SKU 862288
RAN5150561 **219⁹⁹**

- Set of 12 Pieces
- Fits BL-5000 and BL-7000 Series
- Complete Kit Includes: (4) Low-Profile Round Polyurethane Contact Pads, (4) Sliding Receivers to Accommodate the Round Polyurethane Contact Pads, (4) 3" Stackable Adapters



You get it all.



12V DC Option Available

SPECIFICATIONS:	BL-3500SLX	BL-5000SLX	BL-7000SLX
Weight Capacity / Pair	3,500 Lbs. / 1588 kg.	5,000 Lbs. / 2268 kg.	7,000 Lbs. / 3175 kg.
Individual Frame Weight	60 Lbs. / 27 kg.	76 Lbs. / 34 kg.	91 Lbs. / 41 kg.
Platform Lifting Height (Frame Only)	16.5" / 419 mm.	17.2" / 437 mm.	17.7" / 450 mm.
Platform Lifting Height (W/Blocks)	20" / 508 mm.	22.5" / 572 mm.	21.2" / 538 mm.
Minimum Collapsed Height	3" / 76 mm.	3" / 76 mm.	3.5" / 89 mm.
Rubber Block Position Minimum	26.7" / 678 mm.	31.5" / 800 mm.	31.5" / 800 mm.
Rubber Block Position Maximum	50.5" / 1283 mm.	60" / 1524 mm.	60" / 1524 mm.
Frame Width	10.5" / 267 mm.	11" / 278 mm.	12.5" / 318 mm.
Frame Length	62" / 1575 mm.	72.5" / 1841 mm.	72.5" / 1841 mm.
Lifting Time	10 seconds	15-30 seconds	15-30 seconds

Engine Supports

GM Engine Moving Tool

SKU 511006
THX419X **59⁹⁹**

- Fits GM Front Wheel Drive Vehicles with Engine Torque Struts
- Safely Holds Engine in Place
- Extra Bolt Holes Provide Fit on All Vehicles
- Includes Adapter 419A



THEXTON



SCAN FOR DETAILS

3 Point Engine Support Bar

SKU 133617
24951 **79⁹⁹**

- Makes Removal of Transaxle Easy by Supporting Engine of Front Wheel Drive Vehicles
- Width Expands from 34-1/2" to a Full 61"
- (2) 14" Adjustable Hook Screws
- (2) 38" Braided Steel Cables
- 700 Lbs. Capacity



OEM TOOLS

1,100 Lbs. Engine Support

SKU 512946
24950 **99⁹⁹** REG. \$119.99

- (2) Screw Adjusters for Precise Positioning - Makes Job Easier, Faster and Safer
- Rubber Feet to Prevent Damage to Vehicle and Ensure Stability
- 1,100 Lbs. Capacity



SAVE \$20

2 Hooks - 2 Chains
Twice the Adjustment Means Faster, Easier AND Safer

Offer Good Through June 30, 2017 - While Supplies Last

Body Repair Accessories

10,000 PSI Air Actuated Foot Pump

SKU 964639
OMG22903 **294⁹⁹**

- Provides Up to 10,000 PSI with Standard Shop Air Supply of 110 - 175 PSI
- Oil Capacity: 50 Oz.



OMEGA

5 Ton Flat Body Kit

SKU 964667
PPBB65139 **154⁹⁹**

- Ideal for Applications in Limited Spaces
- (4) Adapters for Added Height
- Chrome Plated Plunger



Body Repair

OEM TOOLS

4 Ton Porto Power Kit

SKU 301327
24820 **149⁹⁹**

- Long Handle Provides Low Pumping Effort
- Comes in a Blow Mold Case



4 Ton Porto Power Kit

SKU 964658
PPBB65114 **199⁹⁹**



4 Ton Body Repair Kit

SKU 964654
OMG50040 **174⁹⁹**

- Quick Connect Technology for Effortless Assembly

OMEGA

10 Ton Porto Power Kit

SKU 301328
24821 **219⁹⁹** REG. \$259.99

- Features a Faster (Double-Action) Hydraulic Pump Causing the Ram to Move with Both the Up and Down Strikes of the Arm
- Comes in a Blow Mold Case



SAVE \$40

Offer Good Through June 30, 2017 - While Supplies Last



10 Ton Body Repair Kit

SKU 964656
OMG50100 **274⁹⁹**

- Quick Connect Technology for Effortless Assembly of Attachments to Meet Your Pushing and Pulling Needs
- Includes: Hand Pump, Hydraulic Hose, 10 Ton Ram, 4-1/8", 10", 18", and 28" Extension Tubes, Male Connector, Wedge Head, Serrated Saddle, Flat Base, Ram Toe, Plunger Toe, Rubber Head, 90° Combination Head, Spreader, Dust Cover (for Hose), Dust Cover (for Ram), Hose Coupler, Ram Coupler and Blow Mold Case

10 Ton Porto Power Kit

SKU 964663
PPBB65115 **354⁹⁹**

- Snap-Lock Design for Quick and Easy Assembly
- Automatic Pump Overload System Protects Against Damage to Rams and Equipment
- 1/2 Ton Capacity Hydraulic Spreader Features 2" Jaws and Spreads from 5/8" to 3-3/4"
- Custom Fitted, Rugged Blow Molded Storage Case with Wheels for Easy Movement Between Jobs



JACKS AND HYDRAULICS



All TCE products carry a two (2) year limited warranty.



1,500 lbs. High Position Jack Stand

SKU 451493
TCE40753
99⁹⁹

- Max Height 79-7/8"
- Featuring Heavy-Duty Steel and High-Strength Welds for Safety in Mind
- ACME All Thread Rod Adjustment for Varied Load Heights



10 Ton Round Tube Vehicle Support Stand

SKU 451491
TCE41000
164⁹⁹ each
Adjustment Range: 28-3/8" to 46-7/8"



Dual Piston Pump

6,500 lbs (3-1/4 Ton) Professional Garage Jack

Lifting Range: 3-13/16" to 21-1/8"
SKU 451485
TCE83508
199⁹⁹



7 Ton Square Tube Vehicle Support Stand

SKU 451490
TCE47000
119⁹⁹
(Sold in Pairs)
Adjustment Range: 9-5/8" to 15-3/8"



12-Ton Manual
Lifting range: 9" to 18-1/8"
SKU 451480
TCE91207
84⁹⁹

20-Ton Manual
Lifting range: 10-7/8" to 18-3/8"
SKU 451486
TCE92007
119⁹⁹



1000 lbs Telescoping Transmission Jack

Double Ram for a Lower Profile Saddle Forward Tilt 30 Degree Saddle Reverse Tilt 12 Degree Lifting Range: 35" to 70-1/2"

SKU 451475
TCE50055
749⁹⁹



4,000 lbs (2 Ton) Ultra-Low Profile Garage Jack

Lifting Range: 3" to 20"
SKU 451477
TCE82002
359⁹⁹



12-Ton Air/Hyd
Lifting range: 10-7/16" to 20"
SKU 451478
TCE31000
199⁹⁹

20-Ton Air/Hyd
Lifting range: 10-7/16" to 20"
SKU 451479
TCE31001
229⁹⁹



1 TON Transmission Jack
Saddle Forward Tilt 68 Degree Saddle Reverse Tilt 15 Degree Rated Capacity: 2000 Lbs. Lifting Range: 8-1/4" to 30-5/8"

SKU 451476
TCE10001
629⁹⁹



20 Ton Shop Press
SKU 451481
TCE20021
899⁹⁹

Force: 40,000 lbs
Bed Internal Dimension: 21-5/8"
Working Range: 0" to 39-3/8"

30 Ton Shop Press
SKU 451472
TCE30021
1099⁹⁹

Force: 60,000 lbs
Bed Internal Dimension: 21-5/8"
Working Range: 2" to 44-1/2"

50 Ton Shop Press
SKU 451473
TCE50021
1899⁹⁹

Force: 100,000 lbs
Bed Internal Dimension: 27-15/16"
Working Range: 2-5/8" to 36-1/4"

Torin BIG RED JACKS



3-1/2 Ton Quick pump Floor Jack

SKU 94939
T83014
111⁹⁹



Oil Drainer
18 Gal.

SKU 988738
TRG2018
189⁹⁹

28 Gal.
SKU 988740
TRG2094
229⁹⁹



5 Ton Long Floor Jack

SKU 94943
T80501
510⁷¹



1000 lbs Double Ram Transmission Jack

Lifting Range: 34" to 71"
SKU 988789
TR4055
511¹³



Rolling Tool Cart

SKU 988851
TC325C
199⁹⁹



40 Ton Shop Press

Force: 80,000 lbs
Bed Internal Dimension: 27.12"
Working Range: 0" to 35.04"
SKU 335338
TRD54003
799⁹⁹

45 Ton Shop Press

Force: 90,000 lbs
Bed Internal Dimension: 25.38"
Working Range: 0" to 34.06"
SKU 103248
TRD54501
899⁹⁹

50 Ton Shop Press

Force: 100,000 lbs
Bed Internal Dimension: 27-15/16"
Working Range: 2-5/8" to 36-1/4"
SKU 342096
TRD50002
999⁹⁹



1500 lbs High Position Stand with Foot Pedal

SKU 94929
TRF40753A
99⁹⁹



1000 lbs Double Ram Transmission Jack

Lifting Range: 34" to 70"
SKU 988732
TR4058
458⁹⁹



1000 lbs Transmission Jack

Lifting Range: 49" to 68"
SKU 988731
TR4053
126⁰⁹

Mobile Work Station
SKU 988853
TC327
289⁹⁹



20 Ton Shop Press
Force: 40,000 lbs
SKU 988744
TY20001
561⁹⁹

AutoZone® now offers the full line of Chief® Automotive Products



The industry's trusted brand for live mapping, pulling, anchoring, and specification products.



Call 877-AZTool1 to setup up a demo today!

Leasing Terms Available!†

Ask Your AutoZone®
Commercial Sales Manager

AutoZone®
Tool & Equipment QUARTERLY



Contact us at
877-866-5739

Promo Good While Supplies Last!
Available thru Outside Buy/EPO



PROFESSIONAL TOOLS AND EQUIPMENT



HEAVYWEIGHT QUALITY. KNOCKOUT PRICE.

IMPACT SOCKET SETS

157⁹⁹

KTI33202
19 Piece 1/2" Drive 6 Point
SAE Deep Impact Socket Set
• Heat-treated, chrome-moly steel
• Laser engraved for quick identification
• Set includes deep sockets sized from 3/8" to 1-1/2"
• Lifetime warranty on sockets



107⁹⁹

KTI37400
10 Piece 3/8" Drive Metric 6 Point
Deep Flex Impact Socket Set
• Heat-treated chrome-moly steel
• Sizes include: 10mm thru 19mm
• Lifetime warranty on sockets



428⁹⁹

KTI35100
18-piece 1" Drive
Short Fractional Impact Socket Set
• All sockets are laser engraved
• Lifetime warranty
• Set includes 3/4" to 2"; 7" and 13" extensions
and replacement O-rings and pins



185⁹⁹

KTI38202
26 Piece 1/2" Drive 6 Point
Metric Deep Impact Socket Set
• Heat-treated, chrome-moly steel
• Laser engraved for quick identification
• Set includes deep sockets sized from 10mm to 36mm
• Lifetime warranty on sockets



COUNTER DISPLAY



91⁹⁹

KTI73952-54
Grease Gun Coupler
54 Pack Counter Display
• Grease gun couplers counter display pack
• Quantity: 54
• 6,000 PSI
• For use with hand grease guns only
• Counter display measures: 5.5" x 4.5" x 4.25"
• 1 year warranty on material & workmanship

CHROME SOCKET SETS

76⁹⁹

KTI21044
44 Piece 1/4" Drive 6 Point
SAE and Metric Standard and Deep Socket Set
• Chrome vanadium alloy steel
• Heat treated
• Lifetime warranty on sockets



Includes sizes standard length fractional sockets 3/16" to 9/16", deep fractional sockets 1/4" to 9/16", standard length metric sockets from 4mm to 15mm, deep metric sockets 6mm to 15mm. Includes 1/4" drive Pro Ratchet and 2" and 6" extensions.

107⁹⁹

KTI22047
47 Piece 3/8" Drive 6 Point
SAE and Metric Socket Set
• 3/8" drive Pro-ratchet included
• 2" and 6" extension included
• Lifetime warranty on sockets, ratchet and extensions



Includes sizes 1/4"-7/8" (standard length fractional), 3/8"-7/8" (deep fractional), 6mm-19mm (standard length metric) and 10mm-19mm (deep metric).

107⁹⁹

KTI22547
47 Piece 3/8" Drive 12 Point
SAE and Metric Socket Set
• 3" and 6" Extension included
• 3/8" drive Pro-Ratchet included
• Lifetime warranty on sockets, ratchet and extensions



Includes sizes: 1/4"-7/8" (standard length fractional), 3/8"-7/8" (deep fractional), 6mm-19mm (standard length metric) and 10mm-19mm (deep metric).

BRAKE SERVICE

Brake Lathes

Model 4000SP Single Pass Brake Lathe

SKU 210247
AMM904000SP **5,999⁹⁹**

- Cut Rotors in One Pass, with a High-Quality Finish
- Single Speed Spindle and Feed Rates
- Requires the Purchase of an Adapter Kit of Your Choice



AMMCO



Negative Rake (10 Pack)

SKU 262386
SHA06210 **24⁹⁹**



INCLUDES
Manufacturer's
Set-Up and Training

Leasing Terms Available.
Ask Your AutoZone® Commercial Sales Manager.
Free Delivery!
in 48 Continental United States

Lift Gate Service
SKU 262529
AMMLIFTGATE **55⁰⁰**

BONUS

Brake Lathe Bench Kit

SKU 212739 | Part# AMM902500

and Kit "B"

SKU 496629 | Part# AMM900002

VALUE: \$1,849.98

With Purchase of:

Model 4000SP Single Pass Brake Lathe

SKU 210247 | Part# AMM904000SP

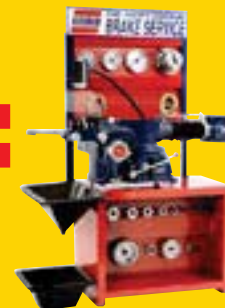

Offer Good Through June 30, 2017
While Supplies Last

Model 4000B Brake Lathe

SKU 534380
AMM904000B **7,699⁹⁹**

- Twin Cutter Tools and Quick Drum-to-Rotor Changeover
- Adjustable Spindle Speeds Allow for Quick Rough Cut/Finish Cut Settings
- Infinitely Adjustable Spindle Feed Gear Box
- User-Friendly Ergonomics
- Supports Drums or Rotors Up to 100 Lbs. Using the 1" Arbor, or Up to 200 Lbs. Using Optional 1-7/8" Arbor



AMMCO



Negative Rake (10 Pack)

SKU 262386
SHA06210 **24⁹⁹**



INCLUDES
Manufacturer's
Set-Up and Training

Leasing Terms Available.
Ask Your AutoZone® Commercial Sales Manager.
Free Delivery!
in 48 Continental United States

Lift Gate Service
SKU 262529
AMMLIFTGATE **55⁰⁰**

BONUS

Brake Lathe Bench Kit

SKU 212739 | Part# AMM902500

and Kit "E"

SKU 496630 | Part# AMM900006

VALUE: \$2,499.98

With Purchase of:

Model 4000B Brake Lathe

SKU 534380 | Part# AMM904000B

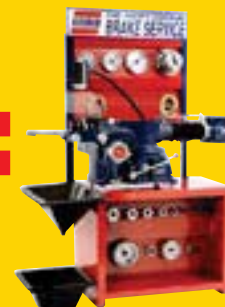

Offer Good Through June 30, 2017
While Supplies Last

Combination Brake Lathe RL8500 Complete Kit Includes Lathe, Adapters and Bench

SKU 901827
RANRL8500 **5,649⁹⁹**

Provides a FASTER, More ACCURATE, and EASIER Resurfacing Capability Than Any Other Brake Lathe in Its Class

- Infinitely Variable Speed Controller Able to Turn Rotors and Drums Faster Providing One-Cut, Micro-Finish Execution Every Time
- Maximum Rotor Diameter: 17"
- Maximum Rotor Thickness: 2-1/2"
- Brake Drum Diameter: 6" - 28"
- Maximum Load with Standard Arbor: 150 Lbs.
- Maximum Load with Truck Arbor: 250 Lbs.



Ranger

(Shown with Optional Equipment. Accessories Not Included)

Truck Adapter Kit for RL8500 Brake Lathe

SKU 899411
RAN5150161 **1,549⁹⁹**

- Super-Duty Truck Tooling Package Consists of an Upgraded 1-7/8" Arbor and a Wide Variety of Adapters
- 36 Piece Set Allows Expanded Coverage to Handle Any Vehicle Through 1 Ton Trucks



Lift Gate Service
SKU 262533
RANLIFTGATE **135⁰⁰**

Positive Rake Bits (10 Pack)

SKU 300786
SHA408-10 **59⁹⁹**



Leasing Terms Available.
Ask Your AutoZone® Commercial Sales Manager.
Free Delivery!
in 48 Continental United States

201 Combination Brake Lathe, Single-Speed

SKU 290004
HOF201TRUECUT **7,199⁹⁹**

- Drive Motor: 1/2 HP (1,725 RPM)
- Arbor Speeds: 185 - 195 RPM
- Arbor Diameter (Standard): 1"
- Maximum Arbor Weight (Standard): 150 Lbs.
- Rotor/Flywheel/Drum Feed Rate per Revolution: 0.0025"
- Rotor/Flywheel Diameter Range: 5" - 18"
- Rotor/Flywheel Facing Travel: 4"
- Max Rotor Thickness: 3"
- Drum Diameter Range: 5" - 14"
- Drum Facing Width: 4"
- Power Requirements: 120V, 1Ph, 60HZ
- Includes Standard Adapters for Cars and Light-Trucks



(Shown with Optional Equipment. Bench and Board Sold Separately)

Leasing Terms Available.
Ask Your AutoZone® Commercial Sales Manager.
Free Delivery!
in 48 Continental United States

Accu-Turn Positive Rake Bits (10 Pack)

SKU 262383
SHA06010 **54⁹⁹**



Work Bench for 201 Brake Lathe

SKU 290008
HOFB206 **529⁹⁹**

Tool Board for 201 Brake Lathe

SKU 290006
HOFB203 **239⁹⁹**

Lift Gate Service
SKU 290017
HOFLIFTGATE **95⁰⁰**

Carbide Lathe Inserts

SKU	PART#	DESCRIPTION	APPLICATION	PRICE
262385	SHA0626	Negative Rake (6 Pack) • Models 3860, 4000, 4100 and 7000	Ammco	17⁹⁹
262387	SHA1042	Positive Rake (2 Pack) • Model 3850	Ammco	17⁹⁹
262386	SHA06210	Negative Rake (10 Pack)	Ammco	24⁹⁹
262389	SHA06810	Positive Rake (10 Pack) • Model BL500 and 501	Hunter	29⁹⁹
262388	SHA1046	Carbide Inserts (6 Pack)	Ammco	34⁹⁹

SKU	PART#	DESCRIPTION	APPLICATION	PRICE
543384	SHA069-10	Positive Rake (10 Pack)	Pro-Cut	49⁹⁹
262382	SHA40710	Carbide Inserts (10 Pack)	FMC	49⁹⁹
262409	SHA80210	Carbide Inserts (10 Pack)	Kwik Way	59⁹⁹
300786	SHA408-10	Positive Rake (10 Pack)	FMC/Ranger	59⁹⁹
262383	SHA06010	Carbide Inserts (10 Pack)	Accuturn	54⁹⁹



SHA1042



SHA1046



SHA80210



Leasing Terms Available!†

Ask Your AutoZone®
Commercial Sales Manager

AutoZone®
Tool & Equipment QUARTERLY

Brake Lathes

Pro-Cut Brake Lathes Correct Rotor Distortion, Rotor Misalignment and Cure Brake Vibration



Pro-Cut 9.2DRO on Car Brake Lathe with 6 Adapter Package

SKU OUTSIDE BUY/EPO **10,399⁹⁹**
PCTPC92-6ADP

- Includes: Pro-Cut 9.2 On-Car Brake Lathe, DRO Computer Box, Speed-Lock Cutting Head, Fixed Post Trolley, 6 Adapter Package, Accessory Kit, 6 Adapter Package (50-681, 50-687, 50-688, 50-693, 50-694, 50-946)
- The 6 Adapter Package Will Fit Import and Domestic 4 Lug Applications Up Through 1/2 Ton Trucks
- On-Site Installation and Training Provided



Available via Outside Buy/EPO, Call 1-877-298-6651 for ordering instructions.

Price Does Not Include Installation or Optional Equipment as Shown

Pro-Cut A10-6 on Car Brake Lathe with 6 Adapter Package

SKU OUTSIDE BUY/EPO **12,999⁹⁹**
PCTPCA10-6ADP

- Includes: A10 Warthog Lathe, 6 Adapter Package and Full Accessory Kit (50-681, 50-687, 50-688, 50-693, 50-694, 50-946)
- Heavy Duty PTO Drive System Provides Twice the Start Up Torque as Our Other Machines. Perfect for Fleet, Heavy Duty and High Car Demand!
- The 6 Adapter Package Will Fit Import and Domestic 4 Lug Applications Up Through 1/2 Ton Trucks
- On-Site Installation and Training Provided
- 2 Year Warranty



Available via Outside Buy/EPO, Call 1-877-298-6651 for ordering instructions.

Price Does Not Include Installation or Optional Equipment as Shown

Call 1-877-298-6651 to Schedule an In-Shop Demo.

Silencer Bands

Small Solid Rotor Silencer Band (6")

SKU 262393 **14⁹⁹**
SHA96



Large Solid Rotor Silencer Band (9")

SKU 262396 **14⁹⁹**
SHA94



AMMCO Style Disc Silencer Band with Lead Weights

SKU 262392 **29⁹⁹**
SHA69



2-3/4" Large Truck Drum Silencer Band

SKU 262391 **49⁹⁹**
SHAA5290



1-3/4" Drum Silencer Band

SKU 262390 **29⁹⁹**
SHA80B



AMMCO Style Large Disc Band with Lead Weights

SKU 262397 **39⁹⁹**
SHA930



Silencer Clamp

SKU 388821 **39⁹⁹**
SHA70B



Call for Individual Sizes

Bleeders

DIY Reverse Brake and Clutch Bleeder

SKU 459112 **59⁹⁹**
PH02104-B

- Easily Bleeds ABS
- Removes Trapped Air
- Attachments to Fit All Vehicles



V-12 Economy Professional Reverse Brake and Clutch Bleeder

SKU 289898 **189⁹⁹**
PH02003

- Bleed the Brakes on Any Vehicle in 10 Minutes or Less, Including ABS
- Save Time and Money on Good Parts Not Properly Bled
- One Man Operation



MaxProHD® Reverse Brake and Clutch Bleeder

SKU 289896 **399⁹⁹**
PH02002

- Bleeds Brakes or Clutches in Half the Time
- Includes a Full Set of Adapters for Vacuum, Pressure, Pulse Generation, Bench and Cross Bleeding Methods



Brake Fluid Testers



Brake Fluid Tester
SKU 191687 **29⁹⁹**
25267

- Calibrated for DOT 4 Fluid
- Small Size and Easy-to-Use Compared to Single Use Strips
- Not for Use with DOT 5 Fluid

Built-in LED Light to Ensure Tips Are in Proper Contact with Fluid



Brake Fluid Tester DOT 3, DOT 4, DOT 5.1

SKU 850067 **29⁹⁹**
25269 REG. \$34.99

- Easily, Quickly and Precisely Check the Water Content of 8 Types of Polyglycol-Based Brake Fluids (DOT 3, DOT 4, DOT 5.1, ACDelco DOT 3, Pennzoil, Prestone, Motorcraft and Toyota DOT 3)

Offer Good Through June 30, 2017 - While Supplies Last



Brake Strip Brake Fluid Copper Test Kit

SKU 289905 **79⁹⁹**
PH03006

- Everything Needed to Test Brake Fluid - Know within 60 Seconds if it's Time for a Change
- Includes: (1) Tube of 100 Strips; (100) Color Rating Cards



Phoenix Systems 8002-B Coolant and Brake Test Strips

SKU 850029 **94⁹⁹**
PH08002-B

- 100 Double Ended Test Strips That Can Be Used to Quickly and Accurately Determine When to Correct or Replace Engine Coolant and Brake Fluid



Hones and Stones



Adjustable Brake Cylinder Hone

SKU 531780 **14⁹⁹**
25032

- Range: 1/2" to 2-1/4" (13 mm to 57 mm)



Brake Cylinder Hone 3/4" to 2-1/2"

SKU 047928 **18⁹⁹**
25028

- Range: 13/16" to 2-1/4" (21 mm to 58 mm)



Replacement Stone Sets

SKU 046789 **5⁹⁹**
2528M

- 2 Medium Grit (#220)



Flex-Hone® Kit BC Kit D 180SC

SKU 341378 **79⁹⁹**
BRMBCKD

- BC Kit D (18 mm, 20 mm, 22 mm, 25 mm, 29 mm)



Brake Spring Tool



Brake Caliper Hanger Set 8 Piece

SKU 312538 **24⁹⁹**
24518

- Prevents Kinking or Premature Failure of Brake Hose
- Keeps Calipers Up and Out of the Way When Servicing Suspension Components, Brakes, Etc.
- Hi Viz Green Powder Coat So You Don't Misplace Them or Leave Them Attached to the Vehicle

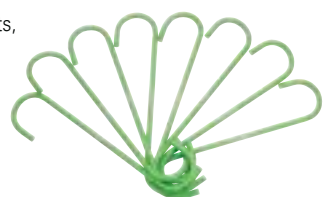

BRAKE SERVICE

Brake Bleeding Tools

One Man Brake Bleeding Kit

SKU 070116 25136 **34⁹⁹**

STORE STOCK

- Easily Diagnose Vacuum and Pressure Related Systems from the EGR to Brake Bleeding to Cooling Systems on Today's Complex Vehicles
- Kit Contains Our Most Popular Hand Vacuum Pump with Vacuum Gauge and Accessories



Universal Fluid Dispensing Bottle

SKU 568477 24443 **34⁹⁹** REG. \$39.99

- Refill the Master Cylinder During Vacuum or Manual Hydraulic Brake or Clutch Bleeding and Flushing
- Mounts Securely to Master Cylinder and Clamps
- Capacity: 50 Oz.

Offer Good Through June 30, 2017 While Supplies Last

SAVE \$5



Vacuum Brake Bleeder

SKU 526506 24440 **59⁹⁹**

- Works with Your Air Compressor to Quickly Bleed Clutches and Brakes on Most Cars and Trucks
- Includes Fill Bottle and Master Cylinder Adapter Set



Refill Kit

SKU 972280 MITMVA6832 **64⁹⁹**

- 40 Oz. (1.2 L) Reservoir Holds Enough Fluid for an Entire Flush
- On/Off Valve Controls Fluid Flow From Reservoir
- Fluid Level Control Maintains Correct Level of Fluid in the Master Cylinder
- Conveniently Adapts for Use with Standard 12 Oz. (355 Ml) and 32 Oz. (946 Ml) Brake Fluid Bottles
- Universal Top-Mount Design



BONUS Refill Kit

SKU 972280 | Part# MITMVA6832 **VALUE: \$64.99**



with Purchase of: Brake Bleeding Kit SKU 604208 | Part# MITMV6830 Offer Good Thru June 30, 2017 While Supplies Last

Brake Bleeding Kit

SKU 604208 MITMV6830 **184⁹⁹**

- Compressed Air Operation
- 1.9 Quart Capacity
- Swivel Air Inlet with Quick Disconnect



Silverline Elite Test Kit

SKU 988888 MITMV8500 **94⁹⁹**

- Provides Either Vacuum or Pressure with Equal Precision and Convenience
- Performs Engine Performance Diagnostics, Brake Bleeding, Fluid Transfer, Evacuation, Sampling and More
- Includes Components Needed to Perform Hundreds of Diagnostic and Mechanical Tests



Pressure Brake Bleeding System

SKU 383099 MITMV6840 **389⁹⁹**

- Large 1.2 Gallon Capacity Dispenser
- Includes 7 Master Cylinder Adapters That Connect to Most U.S., Asian, and European Cars and Light Trucks
- Pressure Gauge Indicates Dispensing Pressure
- Utilizes Push-to-Connect, Quick-Change Adapters
- Integrated Manual Relief Valve For Safety



Code Scanner and Reader

Autel MaxiService EBS301 Electric Brake Service Tool

SKU 255733 AULEBS301 **209⁹⁹**

- Open and Close the Brake Pads, Read and Clear EPB/SBC Codes, Turn Off ECU and Brake Warning Light
- Applications: Citroen, Peugeot, BMW, Renault, Ford, VW, Audi, Opel, Toyota, Land Rover, Jaguar, GM, Daewoo, Benz, Sprinter, Smart, Chrysler, Volvo
- One-Year Free Online Software Updates



Sprayers

Red Powder Coated Aluminum Sprayer

SKU 186463 MSMB8000PL **44⁹⁹**

- 16 Oz. Capacity
- Not for Use with Chlorinated Solvents



Red Powder Coated Steel Sprayer

SKU 186459 MSMA1000R **69⁹⁹**

- 32 Oz. Capacity
- Not for Use with Water-Based Products



Complete Repair Kit for B8000PL

SKU 186467 MSMBK50 **19⁹⁹**



Filler Cap Assembly

SKU 186466 MSMP156 **19⁹⁹**

- Hand Removable
- For Model "A" Sprayers

Complete Repair Kit for Model "A" Sprayers

SKU 186465 MSMK10 **29⁹⁹**

- Includes All Parts That Can Be Replaced
- All Chemical Resistant Seals
- Used for Model A1000R and A2000 32 Oz. Sprayers



Brake Service Tools



Brake Caliper Brush

SKU 250125 25435 **5⁹⁹**

STORE STOCK

- Slim Design for Cleaning Brake Calipers and Other Brake Hardware



2 Piece Hose Pinchers

SKU 191675 25250 **19⁹⁹**

- A Quick, Easy Way to Pinch-Off Vacuum Lines, Fuel Lines, Etc. without Damaging the Line



Brake Cylinder Retainer Remover

SKU 265111 25268 **19⁹⁹**

- Use on GM X and J Body Cars
- Expands and Holds Special Retainer So the Brake Cylinder May Be Removed



8 Piece Manual Brake Gauge Set

SKU 191672 25266 **19⁹⁹**

- Color Coded Brake Gauge Identifies Thickness Levels for Brake Lining Inspection



3/8" Pro Impact Driver

SKU 452628 24213 **24⁹⁹**

- Handle Design Reduces Risk of Hitting Hand
- 3/8" Drive and 5/16" Hex for Phillips and Flat Bits
- Includes: 8 Screwdriver Bits



Spring Brake Tool for GM

SKU 222526 LIS50600 **34⁹⁹**

- Releases Tension on Both Large and Small GM Single Spring Brakes During Servicing



8 Piece Brake Tool Set

SKU 900827 27194 **44⁹⁹** REG. \$49.99

- Includes: Spring Compressor, Brake Spring Installer, Spring Removal Tool, Brake Retaining Spring Tool, Brake Spring Pliers, (2) Brake Adjustment Spoons and Mini Adjustment Spoon

Offer Good Through June 30, 2017 While Supplies Last

Disc Brake Tools

Speedy Pad Spreader

SKU 291417 LIS24300 **42⁹⁹**

- Compresses Disc Brake Pistons in Seconds
- Makes Brake Pad Replacement Easier



Quick Quad Pad Spreader

SKU 080553 LIS29100 **79⁹⁹**

- A Quick Way to Spread Brake Pads and Compress Disc Brake Pistons for Pad Replacement on Single, Double and Quad Piston Calipers
- Simultaneously Compress All Four Pistons on Quad Piston Applications
- Can Be Used While Caliper is on the Vehicle or Hanging Free



Dual Speedy Pad Spreader

SKU 291420 LIS25750 **49⁹⁹**

- Compresses Dual Brake Pistons Simultaneously
- Makes Dual Piston Pad Replacement a Simple Job



Rotor Flex-Hone®

49⁹⁹ each

- Lowers Harmonic Vibrations
- Ideal for New and Re-Turned Rotors and Flywheels

Fine SKU 341310 BRMRMFH240Z25 **49⁹⁹**

Medium SKU 341298 BRMRMFH20Z25 **49⁹⁹**

Coarse SKU 341314 BRMRMFH60Z25 **49⁹⁹**

Brake Hub Resurfacing Kit

SKU 013590 24686 **20⁹⁹**

- Quickly Remove Rust on Lug Studs and Rotors on the Hub Assembly
- Use with Drill for a Quick and Easy Job
- Fits All Passenger Cars, Light-Trucks and SUVs
- Includes 4 Pads

STORE STOCK



Dual Piston Press

SKU 900811 25741 **29⁹⁹**

- Used to Press in Dual Brakes and Single Pistons

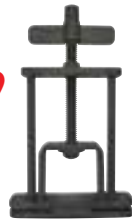

2 and 3 Pin Brake Rewind Adapter Set

SKU 013592 24693 **34⁹⁹**

- Includes 2 Fully Adjustable Adapters That Fit Thousands of Vehicles
- No Need for Multiple Tools
- 3/8" Drive Adapters

STORE STOCK

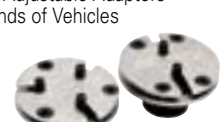

18 Piece Disc Brake Caliper Set

SKU 094798 27113 **59⁹⁹** REG. \$74.99

- Caliper Adapters from 1-3/16" to 2-1/2", Some Specifically to Service Nissan, SAAB and Honda Models
- Caliper Rotation Tool with Left Hand Threads for Ford Applications



Offer Good Through June 30, 2017 While Supplies Last

PAIN'T AND BODY



Contact Us:
1-877-AZTool1 Phone
 (1-877-298-6651) Hablamos Español

Hood Props

OEM TOOLS

Universal Lift Support Adjuster

SKU 191671 16⁹⁹
 25307

- Securely Holds Gas-Charged Lift Supports in Hoods, Tailgates, Hatchbacks and Trunks
- Aluminum Body and Brass Threads Prevent Damage to the Lift Support Shaft



Telescopic Hood Support

SKU 420337 19⁹⁹
 24211

- A Simple Turn Unlocks and Locks Support in Place
- Rubber End Caps Protect Vehicle's Finish
- 21" When Closed and Almost 48" When Fully Extended
- Compact and Easy to Store

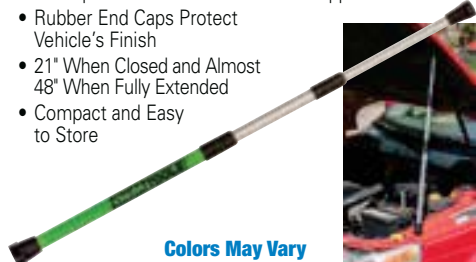

Colors May Vary

Hood Prop with Adapter

SKU 291352 39⁹⁹
 LIS46170

- Includes a Support to Help Prevent Slipping
- 3 Piece Telescoping Shaft Locks in Any Position - (Telescopes from 20" to 48-1/4")



Hatch Jammer Lift Gate and Hatch Holder

SKU 222853 59⁹⁹
 STK17200

- Holds Hatch Open and Secure for Prep, Paint, Buffing and Paintless Dent Removal
- Extends to 59"



Abrasive Media



Glass Bead Coarse Media, 25 Lbs.

SKU 010136 49⁹⁹
 SHA13077

- Ideal for Many Uses
- Prevents Surface Rust
- Paint and Body Applications
- For Use with OEM 24815 Abrasive Blast Cabinet



Glass Bead Medium Grit Media, 25 Lbs.

SKU 010139 49⁹⁹
 SHA13078

Pliers

OEM TOOLS

Hog Ring Plier Set

SKU 447162 44⁹⁹
 25931

- Use for Upholstery Work in Most Domestic and Foreign Cars
- Includes 45° and Straight Hog Ring Pliers



Spray Guns

Duralast

Gravity Spray Gun

SKU 738481 54⁹⁹
 80-373

- Spray Nozzle Tip Size: 1.4 mm
- Air Consumption: 5-10 CFM @ 30-43 PSI
- Gravity Feed Cup Capacity: 20 Oz.



HVLP Spray Gun w/Gauge

SKU 738283 54⁹⁹
 80-376

- Duralast HVLP Gravity Spray Gun Features a High Volume, Low Pressure Sprayer That Reduces Overspray to Provide Smooth, Natural Looking Results
- 20 Oz. Gravity Spray Gun Has a 1.4 mm Tip and is Great for High Volume Paint Jobs



Duralast

3 Piece HVLP Spray Gun Kit

SKU 738479 99⁹⁹
 80-374

- Duralast 3 Piece HVLP Spray Gun Kit Includes High Volume, Low Pressure Sprayers That Reduces Overspray to Provide Smooth, Natural Looking Results
- Includes: (1) 1.4 mm HVLP Spray Gun for Lighter Materials, (1) 1.7 mm HVLP Spray Gun for Heavier Materials, (2) 1,000 ml Aluminum Gravity Paint Cups, (1) Adjustable Locking Pressure Regulator with Gauge and (1) Brush



Duralast

Dent Pullers

STECK

Pull Rod Set

SKU 964653 44⁹⁹
 STK20000

- Super Tough Alloy Steel is Precisely Heat-Treated for Maximum Strength
- Kit Contains: (4) Pull Rods and (2) Pick Rods, Stainless Steel Straight Edge, HS Split Point Drill Bit, Instruction Sheet



Super Dent Puller Set

SKU 265148 169⁹⁹
 25922

- 12 Lbs. Hammer, Slide Hammer Shaft, Slide Hammer Handle, Slide Hammer Adapter, Deep Hook, Short Hook, Door Edge Tool, Claw, Straight Driver, Hook and Chain, Sheet Metal Screw and Holder, Nose Piece with Screw
- Comes in a Blow Mold Case

OEM TOOLS



Door Tools

OEM TOOLS

Door Panel Remover

SKU 048579 9⁹⁹
 25313

- For Easy Removal of Door Panel Clips without Damage



Window and Door Clip Remover/Installer

SKU 191679 9⁹⁹
 25311

- Works on GM, Ford and Other Vehicles Using the Common "C" Type Clip



Door Hinge Adjuster

SKU 447144 44⁹⁹ REG. \$49.99
 25946

- Adjusts Door Hinge Position on Most Vehicles
- Two Head Adapter Works with Large and Small Latches

SAVE \$5



Offer Good Through June 30, 2017
 While Supplies Last

Door Spring Tool

SKU 447118 16⁹⁹
 25336

- Quickly and Easily Remove or Install Door Hinge Springs
- Designed for GM Cars and Light-Trucks



Body Tools

OEM TOOLS

Air Bag Release Tool for GM

SKU 191678 16⁹⁹
 25310

- Fits Most GM Cars, Minivans and Light-Trucks
- Tips are Tapered to Make Removal Easier



5 Piece Fastener and Molding Remover Set

SKU 900801 17⁹⁹
 25314

- Includes (5) Tools for Easy Removal of Fasteners, Molding, Wheel Hubs and More
- For Use on Internal and External Vehicle Molding and Trim Fasteners



Body Clip Pliers

SKU 094657 22⁹⁹
 25923

- Designed to Remove Any Clip Found on Trim, Bumpers, etc.
- Steel Levers Enclosed in Plastic, Prevents Scratches



Panel Clip Pliers

SKU 447154 24⁹⁹
 25930

- Minimizes Risk of Damage to the Clip and Panel During Removal



5 Piece Door Panel and Trim Tool Set

SKU 989263 39⁹⁹
 25312

- Comprised of 3 Door Panels and 2 Trim Tools
- Textured, Comfortable Grips with Thumb Stop and Hanging Hole



Skin Zipper²™ Black

SKU 010125 39⁹⁹
 STK21894

- Air Hammer Driven Door Skinning Tool for the Window Flange
- Self-Lubricating Reinforced Nylon Head
- Crimps Door Skin to the Door Shell at Window Opening



Replacement Head

SKU 010118 24⁹⁹
 STK21895



AI Skin Zipper™ Red

SKU 010133 44⁹⁹
 STK21892

- For Any 1 mm Aluminum Skin and 1.5 mm Door Shell
- Skins Doors in Approximately 15 Minutes
- Self Lubricating Reinforced Nylon Head



Replacement Head

SKU 010130 29⁹⁹
 STK21893



AI Skin Zipper²™ Red

SKU 010121 44⁹⁹
 STK21896

- Air Hammer Driven Skinning Tool for Aluminum Doors
- Self-Lubricating Reinforced Nylon Head
- 2 Step Process



Replacement Head

SKU 010123 29⁹⁹
 STK21897



3 Piece Seam Splitter Set

SKU 265129 29⁹⁹ REG. \$39.99
 25337

- Includes Straight, 30 Degree Offset and 90 Degree Angle Seam Splitters
- Tough Chrome Vanadium Steel
- Go Through Shafts
- Shock Dampening Grip Provides Comfort



SAVE \$10

Offer Good Through June 30, 2017
 While Supplies Last

Easy Pry Tool

SKU 222857 19⁹⁹
 STK21730

- Non-Marring Wedge
- 1" Blade with a Curved Clip End That Allows Easy Access and Removal of Plastic Bezels, Moldings, Trim and Panels without Scratching the Surface



OIL CHANGE

Oil Filter Sockets

32 mm and 36 mm Double Sided Oil Filter Socket

SKU **020797**
25421 **19⁹⁹**

- 3/8" Drive
- Applications: VW TDI [2011-2016], Touareg and VR6 Motors [2009-2016]; Audi Q3 and S3 with 2.0 T Gas [2015-2016]; O7 [2007-2010] and A6 3.0T [2014-2016]; BMW 335d, X5 35d [2009-2011] and BMW 6 and 8 Cylinder Engines [1994-2005]; Volvo Models [2007-2014]; Chevy Cobalt, Impala and Malibu with 2.2 and 2.4 Liter Engines [2007-2014]; Porsche Models [2009-2016]

OEM TOOLS



3 Piece Low Profile Oil Filter Socket Set

SKU **094803**
27204 **22⁹⁹**

- Includes 27, 32 and 36 mm
- 3/8" Drive
- Comes in a Blow Mold Case



14 Piece Drain Plug Socket Set

SKU **818568**
25374 **49⁹⁹**

- Designed for Both Foreign and Domestic Vehicles Including: BMW, Ford, Mazda, Mercedes-Benz, Nissan, Peugeot, Renault and More
- Ideal for Removal of Oil Drain Plugs from Manual Transmissions, Transfer Cases, Differential Housings and More
- Includes: (Hex) 9, 10, 12, 14 and 17 mm; (Square) 7, 8, 11, 13 mm, 5/16", 3/8"; (Female Square) 10 mm; (Male Triangle) 10 mm, (Tamper-Proof Triple Square) 16 mm



7 Piece Oil Filter Removal Wrench Set

SKU **191682**
27197 **39⁹⁹** REG. \$49.99

- 3/8" Drive
- Includes: 24 mm for Cadillac; 27 and 36 mm for Mercedes, VW, Cadillac, Buick, Saturn, SAAB; 29 mm for Dodge Cummins Fuel Filter; 30 mm for Korean Cars; 32 mm for GM, Saturn and SAAB; 35/36 mm for Ford Diesel, Mini Cooper, BMW and Mack; 38 mm for Vauxhall/Vectra



Offer Good Through June 30, 2017 - While Supplies Last

Low Profile Oil Drains

17 Gallon Low Profile Truck Drain

SKU **526486**
LIN3665 **369⁹⁹**

- 6' Hose Extends from the Bottom of the Reservoir and Can Be Connected to a Pump to Evacuate Fluid from the Drain



17 Gallon Low Profile Truck Drain with Hand Pump

SKU **526485**
LIN3667 **489⁹⁹**

- Features a Rotary Hand Pump and a 6' Discharge Hose with a Steel J-Hook



17 Gallon Low Profile Truck Drain with Electric Pump

SKU **526487**
LIN3669 **614⁹⁹**

- Features a Durable 120V Electric Pump Installed Below the Front of the Reservoir
- Pump Operates with a Standard Power Outlet and Discharges Fluid Through a 6' Hose with Steel J-Hook



Oil Filter Wrenches

Professional 3 Legged Filter Wrench

SKU **231212**
25413 **19⁹⁹**

- Range: 2-1/2" to 4-1/2"
- Fits 3/8" Drive Ratchet and Extensions



10" Master Oil Filter Locking Pliers

SKU **850037**
25323 **22⁹⁹**

- Capacity: 2-1/8" to 4-1/2" (55 to 120 mm)
- Length: 10" (200 mm)
- Provides Ability to Turn without Squeezing
- Removes Oil Filters in Hard-to-Reach Areas



15" Chain Wrench

SKU **452624**
22659 **39⁹⁹**

- Great for Stubborn Oil Filters
- Designed for Tight Spaces
- Double-action Allows Use in Either Direction
- Chrome Plated to Resist Rust
- Strong I-beam Handle Construction



Toyota/Lexus Oil Filter Cap Wrench Set

SKU **383457**
25409 **29⁹⁹** REG. \$39.99

- Sizes: 64 mm, 73 mm and 74 mm
- Use in Conjunction with a 22 mm or 7/8" Socket or Wrench

SAVE \$10



Offer Good Through June 30, 2017 While Supplies Last

10 Piece Cap Filter Wrench Set

SKU **900828**
27196 **42⁹⁹**

- (10) 3/8" Drive Cap Oil Filter Wrenches
- Includes: 65/67 mm - 14 Flutes, 80 mm - 15 Flutes, 68 mm - 14 Flutes, 86 mm - 16 Flutes, 74/76 mm - 15 Flutes, 93 mm - 15 Flutes, 76 mm - 14 Flutes, 93 mm - 36 Flutes, 76 mm - 30 Flutes, 100 mm - 15 Flutes

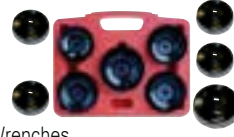

9 Piece Oil Filter Cap Wrench Set

SKU **255627**
27199 **119⁹⁹**

- (3) Forged Low Profile Socket Wrenches Included: 27 mm, 32 mm and 36 mm
- (5) High Quality, Chrome Plated Aluminum Wrenches: 1 Adjustable, 63 mm to 83 mm Sizes and a Filter Wrench for Universal Applications
- All Wrenches are Designed to Work with 3/8" Square Drive Tools
- Includes Application Chart



Oil Filter Cap Wrenches

SKU	Part #	Description	Size	Price
383456	25408	2006 BMW Series (E90) and All 1999 - 2005 Volvo Cars (Except 2005 40 and 50 Series)	86.5 mm, 16 Flutes	19.99
255634	25451	2005 Toyota on Cartridge Style - Fits 4 and 6 Cylinder Engines	64.5 mm, 14 Flutes	19.99
255669	25452	BMW (M44 Engine), Mercedes (M102, M103 Engines), Porsche (924, 928), VW, Audi	74.2 mm, 14 Flutes	19.99
255675	25453	BMW (N52, N54, N55, N63 Engines - 2006 to 2012), Volvo (All Models except 2005 40 and 50 Series)	64.5 mm, 14 Flutes	24.99
255659	25454	Hyundai, Kia	88.8 mm, 15 Flutes	19.99



Accessories

Super Transmission Drain Funnel

SKU **291377**
LIS17902 **49⁹⁹**

- Extends the Catch Area of Any Lift Drain
- Fits the Ford E 40D



Transmission Drain Funnel

SKU **291376**
LIS17892 **24⁹⁹**

- Funnel Size: 22" x 23"



Replacement Funnel for OEM 8 and 18 Gallon Oil Drains

SKU **526493**
25896-1 **34⁹⁹**



No Splatter Pads

- Insert Pad in Funnel or Pan Before Oil Change to Eliminate Oil Splatter
- Porous Material Allows Fluid to Quickly Pass Through Into Funnel or Pan



22 Inch Square

SKU **080574**
LIS38780 **29⁹⁹**

15 Inch Round

SKU **080548**
LIS38750 **19⁹⁹**



Fluid Management

Right Angle Funnel

SKU **020782**
LIS17232 **14⁹⁹**

- 10" Tall Translucent Funnel with a 6-3/4" Offset
- Funnel Mouth: 3.5" O.D.
- Spout: .7" O.D.



Truck/Trailer Wheel Pan

SKU **291383**
LIS19852 **19⁹⁹**

- Catches Oil from Wheel Hubs After Removing Cap
- Capacity: 88 Oz.
- Handle Compartments Hold Hub Nuts Out of the Oil



4.5 Gallon Drain Pan (Green)

SKU **255766**
LIS17952 **26⁹⁹**

- Pan is Resistant to Chemicals and Solvents
- 1" Wide Diameter Spout for Quick and Easy Pouring



Oil Drain Pan Clear with Level Scale

SKU **568469**
87013 **12⁹⁹**

- Great for Transmission Fluid Changes
- Built-In Level Scale Lets You See Fluid Levels
- Built-In Shelf for Draining Filters

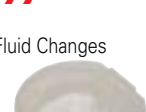

4 Piece Oil Drain and Funnel Set

SKU **754740**
68985 **24⁹⁹**

- Includes:
 - Oil and Transmission Funnel
 - 850 cc Square Oil Funnel
 - Drain Pan with Level Scale 13.8" x 12.6" x 4.3"
 - 2.8 Quart Low Profile Oil Drain



2.8 Quart Low Profile Oil Drain Pan

SKU **568474**
87017 **14⁹⁹**

- Low Profile Oil Drain Pan
- Dimensions: 15.9"(L) x 8.5"(W) x 2.68"(D)
- Capacity: 2.8 Quarts



Oil Drain Basin with Pour Spout

SKU **568473**
87016 **26⁹⁹**

- Pour Spout and 2 Handles to Allow for Easy Spill-Free Work
- Anti-Splash Lip Capacity: 4 Gallons
- 17.7" Diameter



Drum Drain Basin for 5 to 8 Gallon Bucket

SKU **568471**
87014 **19⁹⁹** REG. \$26.99

- Fits on Top of Standard Size 5 to 8 Gallon Drums
- Ribbed Drainage Channels
- Filter Gate to Catch Foreign Objects
- Size: 13.8" Diameter
- Capacity: 3.2 Quarts
- Offer Good Through June 30, 2017 - While Supplies Last



SAVE \$7



*Bucket not included

10L Oil Jug

SKU **87018** **24⁹⁹**

- Safe for Automotive Oils and Fluids
- Convenient Carry and Pour Handles
- Spill Proof Caps



Drum Drain Basin for 55 Gallon Drum

SKU **568472**
87015 **49⁹⁹**

- Fits on Top of Standard Size 55 Gallon Drums
- Ribbed Drainage Channels
- Filter Gate to Catch Foreign Objects
- Size: 26" Diameter
- Capacity: 21 Quarts



*Drum not included



Contact Us:
1-877-AZTool1 Phone
 (1-877-298-6651) *Hablamos Español*

AutoZone®

Tool & Equipment QUARTERLY

Pumps

Multi-Use Fluid Transfer Pump
 SKU 094647 25713 **14⁹⁹**

- Small and Lightweight
- Intake and Discharge Transfer System
- Pumps Air Into Inflatables
- Includes: (2) 50" (127 cm) Long Hoses

Fluid Siphon Pump
 SKU 568475 24863 **17⁹⁹**

- Transfers Fluids Easily
- Use to Transfer Gas, Water, Oil and Other Non-Corrosive Liquids
- Hose Reaches 6 Ft. with 1/2" Diameter

Battery-Operated Liquid Transfer Pump
 SKU 471071 25712 **19⁹⁹**

- Move Liquids Safely and Easily with This Convenient Handheld Pump
- Pumps Gas, Water, Oil and Other Non-Corrosive Liquids
- Pumps Up to 6 Quarts of Liquid per Minute

Polypropylene Lever-Action Pump
 SKU 688036 24471 **29⁹⁹**

- Ideal for Diesel, Kerosene, Lubricants and Other Oils
- Not for Gasoline, Water-Based Chemicals or DEF

Polypropylene Lever-Action Pump with Stainless Steel Rod
 SKU 688038 24472 **29⁹⁹**

- Ideal for Pumping Diesel, Oils, Kerosene, Water-Based Chemicals, Bases and Mild Acids
- Not for Gasoline or DEF

Hand Oil Pump
 SKU 462495 24381 **29⁹⁹**

- Oil Pump for Use with Oil-Based Fluids, Heating Oils, Motor Oils, Heavy and Light Oils, Diesel and Kerosene
- Built-In 1-1/2" and 2" Bung for Use on 16 to 55 Gallon Drums with Either Opening
- Not for Gasoline

Ryton® Lever-Action Pump with Stainless Steel Rod
 SKU 688037 24473 **39⁹⁹**

- Ideal for Pumping Diesel, Oils, Kerosene, Water-Based Chemicals, Bases and Acids Including DEF
- Not for Gasoline

Rotary Barrel Pump
 SKU 462486 24382 **39⁹⁹**

- Fluid Transfer Pump for Use with Oil-Based Fluids, Heating Oils, Motor Oils, ATF, Diesel and Kerosene
- Not for Gasoline

Polypropylene Rotary Drum Pump
 SKU 688035 24470 **69⁹⁹** REG. \$79.99

- Ideal for Pumping Diesel, Oils, Kerosene, Water-Based Chemicals, Bases and Mild Acids
- Not for Gasoline or DEF

Offer Good Through June 30, 2017 While Supplies Last

Lever-Action Barrel Pump
 SKU 970530 LIN1340 **79⁹⁹**

- Pumps Non-Corrosive Fluids, Not for Gasoline
- Telescoping Tube for 16 to 55 Gallon Drums
- Removable Non-Drip Spout Allows for Threaded Hose Connection

Manual Gear Lube Dispenser
 SKU 174166 LIN1293 **99⁹⁹**

- 5 Ft. Hose, 13" Pump Tube
- Fits 25 - 50 Lbs., 5 Gallon Container
- Delivers 1 Oz. per Stroke

Manual Rotary Pump with Hose for 55 Gallon Drums*
 SKU 265089 LIN1385H **229⁹⁹**

- Includes: 8 Ft. x 3/4" Anti-Static Hose with Non-Sparking Aluminum Nozzle with Hanger; Seal Tight Telescoping Pick-Up Tube with Strainer for 16 - 55 Gallon Drums with 2" Bung and H.D.

Manual Rotary Pump for 55 Gallon Drums**
 SKU 462977 LIN1385 **169⁹⁹**

*Drum Not Included **Hose and Drum Not Included

BONUS
 5 Qt. Measuring Can
 SKU 298486 | Part# LING525
VALUE: \$44.99

with Purchase of:
Manual Rotary Pump with Hose
 SKU 265089 | Part# LIN1385H

Offer Good Thru June 30, 2017 While Supplies Last

Manual Rotary Fuel Pump with Hose for 55 Gallon Drums
 SKU 265088 LIN1387 **269⁹⁹**

- 3 Vane Manual Rotary Pump for Most Fluid Types Including Gasoline, Diesel, Kerosene, Coolant, Non-Corrosive Materials, Medium Viscosity Petroleum Based Fluids, Hydraulic Oils and ATF

* Drum Not Included

Grease Pump Package
 SKU 110259 LIN6917 **924⁹⁹**

- Portable 50:1, Air Operated, Double-Acting Grease Pump Ensures High-Output Grease Delivery
- Lube Fitting with Control Valve and Universal Swivel
- Standard Follower Wipes 120 Lbs. Drum Sides Clean and Keeps the Pump Primed

12V Fuel Transfer Pump
 SKU 754742 LIN1550 **489⁹⁹**

- Delivers Fuel at a Rate of 15 Gal/Min. (57 L/Min.)
- 13' (4 m), Heavy Duty, Anti-Static Hose That is Kink Resistant
- Pre-Wired with a Heavy Gauge 18 Ft. (5.4 m) Cable for Operator Convenience
- Applications: Diesel, Kerosene or Mineral Spirits From Both Mobile and Stationary Tanks

Grease Service

Professional Lever Action Grease Gun
 SKU 094656 25893 **29⁹⁹**

- Lever Action Handle with Textured Rubber Non-Slip Grip
- Lightweight, Rust-Free Anodized Aluminum Barrel

Professional Pistol Grip Grease Gun
 SKU 094654 25892 **29⁹⁹**

- 12" Heavy Duty Nylon Hose with Coupler
- 5.5" Extension with 1/8" NPT Male Threads
- Working Pressure: 4,500 PSI

Air Grease Gun
 SKU 125116 25818 **49⁹⁹**

- Great for Automotive, Workshop and Marine Use
- Operating Pressure: 30 - 150 PSI
- Delivery Pressure: 1,200 - 6,000 PSI
- Air Consumption: 4.0 CFM

Extra Heavy-Duty Pistol Grip
 SKU 445385 LIN1134 **59⁹⁹**

- 18" Whip Hose
- Includes Rigid Pipe
- Jam Proof Handle
- Variable Stroke Design
- 7,500 PSI
- Filler Nipple/Bleeder Valve

7 Piece Grease Fitting Adapter Kit
 SKU 978118 25711 **29⁹⁹**

- Includes: Press-On 90° Lube Tool, Straight Extension, 300 mm Hose Extension, Slide-On 90° Coupler, Rubber Tip Nozzle, Needle Nozzle, 360° Coupler

Bearing Packer
 SKU 900799 25073 **29⁹⁹**

- Works on Bearings Up to 3-1/2" O.D.
- Forces Old Grease Out and New Grease In

PowerLuber

20V Li-Ion PowerLuber Kit
 SKU 751676 LIN1884 **354⁹⁹**

- Delivers Grease at Up to 10,000 PSI
- Built-In Led Illuminates the Work Area
- Multi-Function LCD Display
- Includes: Grease Gun, 2 Batteries, Charger and Case, 36 In. Flex Hose

12V Li-Ion PowerLuber Kit
 LIN1264 **249⁹⁹**

Fluid Evacuators

Fluid Evacuator (1.9 Gallon)
 SKU 594882 MITMV7400 **104⁹⁹**

- Integrated 1.9 Gallon (7.3 Liter) Capacity Reservoir
- Large Base with Foot Stabilizer

Fluid Evacuator (1.4 Gallon)
 SKU 544744 24389 **74⁹⁹** REG. \$79.99

- 1.4 Gallon (5.6 Quarts, 5.3 Liters) Reservoir with Hand Operated Pump
- 5 Ft. of Flex Hose and (2) Dipstick Hoses
- Use to Extract Most Fluid Types: Engine Oil, Transmission Fluid, Gear Oil, Coolant, Power Steering Fluid

Offer Good Through June 30, 2017 - While Supplies Last

Fluid Evacuator (2.5 Gallon)
 SKU 547010 24397 **99⁹⁹** REG. \$119.99

- 2.5 Gallon (9.5 Liters)
- Extracts All Types of Engine, Transmission and Lubricating Oils
- Extracts Fluids Through Dipstick Tubes as Well as Other Openings
- Float Assembly to Prevent Overflow

Offer Good Through June 30, 2017 - While Supplies Last

Dispensers

5 Quart Translucent Oil Dispenser
 SKU 544816 87011 **18⁹⁹**

- Translucent White Material Enables the User to See the Liquid Level
- Includes Flexible Spout

8 Quart Dispenser Lid and Cap
 SKU 080078 LIS19702 **29⁹⁹**

- Spout Cap and Lid to Keep Out Contaminants
- Many Large SUVs and Trucks Now Require More Oil

Flexible Spout Measuring Cans

- Designed for One-Hand Operation
- 14" Flexible Spout with Tapered Tip
- Recessed Bottom Drains Fully and Guards Against Punctures
- Rolled-Edge Top Helps Prevent Spilling

5 Quart
 SKU 298486 LING525 **44⁹⁹**

8 Quart
 SKU 298473 LING528 **49⁹⁹**

PneumatiVac Fluid Evacuators

PneumatiVac Fluid Evacuator (2.3 Gallon)
 SKU 497203 MITMV7300 **139⁹⁹**

- Operates on Compressed Air
- 2.3 Gallon (8.8 Liter) Capacity Reservoir
- Large Base with Foot Stabilizer
- Independent Air Shut-Off Valve

Brake Bleeder Adapter Hose for Fluid Evacuators 24389 and 24397
 SKU 568479 24446 **19⁹⁹**

- Quickly Connects to OEMTOOLS® Models 24389 or 24397 Fluid Evacuators Converting Them Into One-Person Vacuum Brake or Hydraulic Clutch Bleeders

Transmission Refill

Automatic Transmission Refill System
 SKU 265092 MITMV6410 **324⁹⁹**

- Includes: Reservoir Lid with Integrated Manual Pump, Pressure Gauge, and Pressure Relief Valve, 5 Ft. Fluid Dispensing Hose, MVA5800 ATF Refill Adapter Kit, Fluid Dispensing Wand and Hanging Hook

ATF Refill and Universal Fluid Dispensing System

ATF Refill and Universal Fluid Dispensing System
 SKU 526508 24441 **199⁹⁹**

- Complete System for Servicing Sealed Automatic Transmissions
- Includes Adapters to Fit Ford, BMW, Honda, Nissan, VW, Porsche, Mini Cooper, Audi and Mercedes Transmissions

Drain Plugs

SMART-O™ 38 Plug Starter Kit
 SKU 404638 BRA38 **134⁹⁹**

- Kit Includes: 38 Plugs with Washers; 6 Each: F1; 5 Each: R1, R6; 4 Each: F3, R9; 3 Each: R3; 1 Each: R4, R5, R11, R16, R20, R21, R22, R23, R24, S13, S18
- Does Not Include POS Materials

IT'S REUSABLE!

COOLING SYSTEM

Cooling System Testers

Cooling System Pressure Test Pump

- SKU 434722 27069 **69⁹⁹**
- Quickly and Easily Pressure Test Cooling Systems in Most Vehicles
 - High Quality Pressure Pump Designed to Work with Most Cooling System Adapters
 - Easy Lever Style Pressure Relief Valve



Universal Cooling System Adapter Set

- SKU 434723 27067 **79⁹⁹**
- Designed to Fit Most Passenger Vehicles and Light-Duty Trucks
 - Fits Both Radiators and Plastic Reservoirs
 - Universal Design Works with Any Cooling System Pressure Pump
 - Pressure Test Pump Not Included



Universal Cooling System Pressure Test Kit

- SKU 434717 27068 **129⁹⁹**
- Quickly and Easily Pressure Test Cooling Systems in Most Vehicles
 - Includes 3 Expandable Adapters That Take the Place of Numerous Specialized Adapters
 - Prevents Damage to Plastic Reservoir Threads That Occurs When the Wrong Adapter is Forced On



Cooling System Pressure Test Set

- SKU 391374 27065 **139⁹⁹** Reg. \$159.99
- (2) 32 mm (9.5 mm and 15 mm Depth) Radiator Adapters are Included to Fit a Variety of Radiators on the Market
 - Cap Adapter for These Systems is Also Included
 - System Works with Most Other Tester Systems
 - Pump is Corrosion Resistant



SAVE \$20

Offer Good Through June 30, 2017 - While Supplies Last

Works with the OEMTOOLS[®] Adapters on Page 67

SmartFit™ Universal Cooling System Test Kit

- SKU 250709 RED950700 **199⁹⁹**
- Works on All Passenger Vehicles and Light-Duty Trucks
 - Eliminates the Need to Buy Costly Adapters for Radiators
 - Made from Anodized Brass and High Quality Materials
 - Made in the U.S.A.



Cooling System

3 Piece Hose Pinching Pliers Set

- SKU 013529 24689 **12⁹⁹**
- STORE STOCK**
- Designed to Clamp Hoses Shut and Lock Them Into Place
 - Clamps Fuel Injection, Brake, Vacuum and Cooling System Hoses
 - Designed with Smooth, Rounded Jaws to Prevent Hose Damage
 - Small: 1/8" to 5/16"
 - Medium: 1/2" to 3/4"
 - Large: 3/4" to 2-1/2"



Locking Hose Pinch-Off Pliers

- SKU 626113 24432 **17⁹⁹**
- Features Locking Ratchet Mechanism to Hold Jaws Tightly in Place
 - Eliminates the Need to Drain the Radiator When Servicing Cooling System
- SKU 626110 24431 **19⁹⁹**
- Clamp Cooling System Hoses Up to 1-1/4" (30 mm) in Diameter

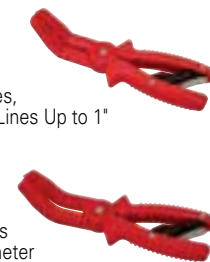

No-Spill Coolant Filling Funnel Kit

- SKU 802197 87009 **29⁹⁹**
- 5 High Quality 1 Piece Adapters - No Assembly or Searching for Loose Parts
 - Simply Select the Correct Adapter, Attach the Funnel and Fill
 - Includes Extensions and Adapters for Hard-to-Reach Surge Tan



2.4 Gallon Plastic Radiator Filler

- SKU 754738 87104 **26⁹⁹**
- Impervious to Oil, Gasoline and Antifreeze
 - Stands Up to Extreme Weather
 - Double Handles on the Back and Top Make it Easy to Pick Up and Easy to Control



2 Piece Hose Clamp Pliers

- SKU 972767 25198 **24⁹⁹**
- Services Most Ring-Type or Flat-Band Hose Clamps
 - Jaws Swivel to Access Hose Clamps in Any Position



Hose Clamp Pliers

- SKU 607069 25246 **36⁹⁹**
- STORE STOCK**
- Removes Plastic and Metal Self-Tightening Hose Clamps with Diameters of 11/16" to 2-1/2"



5 Piece Hose Clamp Plier Set

- SKU 965836 27159 **34⁹⁹** Reg. \$39.99
- Services Most Ring-Type or Flat-Band Hose Clamps
 - Jaws Swivel to Access Hose Clamps in Any Position



Offer Good Through June 30, 2017 While Supplies Last

Professional Series Ethylene Glycol Antifreeze Tester

- SKU 750007 24507 **16⁹⁹**
- For Testing Hot or Cold Ethylene Glycol-Based Coolants Including Dex-Cool[®]
 - Easy-to-Read Discs are Magnified by Convex Design of the Clear, Thermal Resistant Plastic Barrel
 - Disc-Type 16-1/4" Tester is Accurate at All Temperatures
 - Celsius and Fahrenheit Scales



Cooling System Back Flush Tool

- SKU 750008 24506 **26⁹⁹**
- Hose Fittings: 1/2", 5/8" and 3/4"
 - Connects to a Normal Garden Hose
 - Made of Non-Corrosive Aluminum
 - Easy-to-Use



4 Piece 15" Jumbo Pick Set

- SKU 094658 25940 **24⁹⁹** Reg. \$29.99
- Includes: Straight, 90°, Offset and Hook Pick
 - Chrome Vanadium Steel for Strength and Durability
 - Chrome Finish to Resist Rusting
 - Cushion Grip Handles



Offer Good Through June 30, 2017 - While Supplies Last

Fan Clutch Holding Tool

- SKU 209526 27171 **44⁹⁹** REG. \$49.99
- Aids in Changing Fan Clutch by Holding the Pulley
 - Fits Many GM, Ford and Dodge Vehicles



SAVE \$5

Offer Good Through June 30, 2017 - While Supplies Last

5 Piece Fan Clutch Wrench Set

- SKU 110280 27186 **79⁹⁹**
- Set Includes 5 Wrenches and 9 Sizes: 36, 40, 48, 54, 57, 68, 72, 76, 83 mm
 - Ideal for Removing Fan Clutch from the Water Pump

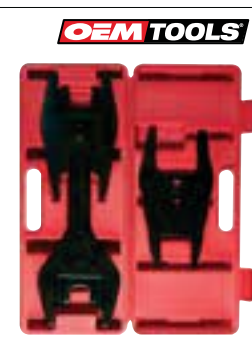

Water Pump Holding Tool for GM

- SKU 094808 27207 **34⁹⁹**
- Use for 2002 - 2008 GM 2.2L and 2.4L Eco Tech Engine in Chevrolet, Oldsmobile, Pontiac and Saturn Platforms



Master Freeze Plug Installation Tool Kit

- SKU 965837 27208 **99⁹⁹**
- Designed to Remove and Install Freeze Plugs Used in Liquid-Cooled Gas and Diesel Engines



Fluid Evacuator (2.5 Gallon)

- SKU 547010 24397 **99⁹⁹** REG. \$119.99
- 2.5 Gallon (9.5 Liters)
 - Extracts All Types of Engine, Transmission and Lubricating Oils
 - Extracts Fluids Through Dipstick Tubes as Well as Other Openings
 - Float Assembly to Prevent Overflow



SAVE \$20

Offer Good Through June 30, 2017 - While Supplies Last

Fluid Evacuator

- SKU 594882 MITMV7400 **104⁹⁹**
- Integrated 1.9 Gallon (7.3 Liter) Capacity Reservoir
 - Large Base with Foot Stabilizer



Block Tester

- SKU 695104 33627145 **25⁹⁹**
- Locate Internal Combustion Leaks Quickly and Easily
 - When Fluid Turns from Blue to Yellow a Combustion Leak is Present



Block Tester Test Fluid (8 Oz.)

- SKU 391381 25739 **8⁹⁹**
- STORE STOCK**
- Use with Block Tester #33627145



Disconnect Tools

Heater Hose Disconnect Tool

- SKU 695607 33627106 **19⁹⁹**
- Removes Heater Hoses with 5/8" and 3/4" Quick Disconnect Couplings on Ford Aerostar Vans 1986 to Current and Full Size Ford Vans 2001 to Current
 - Works on Rear Heater Hose Couplings on Chrysler and Plymouth 1986 to Current



Coolant Hose Removal Tool Set

- SKU 383214 CAL244TNZ **29⁹⁹**
- Thicker Than Most Hose Disconnect Tools
 - 40° Offset Designed for Jobs in Tight Spaces
 - Low-Profile Design for Ease of Use
 - Set of Four Will Cover Quick Connect Hose Needs



Master Disconnect Set

- SKU 821445 33627318 **90⁰⁰**
- Easily Disconnects A/C Lines, Fuel Lines and Transmission Cooler Lines
 - Includes: Hydraulic Clutch Line Disconnect for GM, 3/8" and 5/16" Fuel Line Retaining Clips for GM, Air Conditioning/Fuel Line Disconnects: 5/16", 3/8", 1/2", 5/8", 3/4" and 7/8"
 - Scissor Disconnects: 5/16" and 3/8"; 1/2" and 3/8"
 - Ford: Fuel Line, Oil Cooler Line and Clutch Coupling Remover
 - Coupler Disconnects
 - Comes in a Sturdy Blow Mold Case





Contact Us:
1-877-AZTool1 Phone
 (1-877-298-6651) *Hablamos Español*

Coolant Pulsator Cooling System Flush Tool

SKU 012619
 HCT118550 **699⁹⁹**

- Reduce Come-Backs Caused by Low Coolant Flow and Premature Water Pump Failure
- Patented Pulsating Design Removes Restrictive Sludge, Debris, Sand and Scale Deposits from Heater Cores, Radiators, and Engines. Returns Coolant Flow and Cabin Heat to Like New.
- Included Accessories Connect with Quick Coupler - Large Rubber Cone, Whip Hose with Small Rubber Cone, 5/8" and 3/4" Hose Barb Connectors and Back Flow Preventer



Cooling System AirEvac

Airvac Coolant Refiller

SKU 568478
 24444 **79⁹⁹** REG. \$99.99

- Quickly Refills Cooling System and Eliminates Trapped Air
- Helps Prevent Come-Backs and the Threat of Engine Damage
- Performs Vacuum Leak Tests
- Covers Most Radiator and Reservoir Types

SAVE \$20



Offer Good Through June 30, 2017 - While Supplies Last

Cooling System AirEvac Kit

SKU 099292
 27066 **99⁹⁹**

- Uses Shop Air to Evacuate the Cooling System for Vacuum Leak Testing
- Refills Cooling System without Trapping Air That Causes Overheating
- Universal Adapter Forms an Airtight Seal with Radiator and Coolant Bottle Necks
- Self-Locking Quick Disconnects for Fast Assembly



Adapters

Acura, Chevrolet, Chrysler, Geo, Honda, Isuzu, Lexus, Mazda, Mitsubishi, Suzuki and Toyota

SKU 133624
 27244R **31⁹⁹**

- Fits Early Models Directly to Radiator with 32 mm Opening and a 9 mm Depth



BMW

SKU 133634
 27250R **34⁹⁹**

- Fits Models with Threaded Filler Necks Up to 1987
- Diameter: 32 mm; Thread Size: 3 mm



BMW and Range Rover

SKU 133635
 27251R **29⁹⁹**

- Fits BMWs from 1988 - 2006, Land Rover and Range Rover Models 1995 - 2005
- Diameter: 52 mm; Thread Size: 4 mm



BMW 3 Series (2006 and Later) and 5 and 6 Series (2005 and Later)

SKU 133825
 27252R **34⁹⁹**

- Diameter: 52 mm; Thread Size: 3 mm



Cadillac, Chevrolet, Geo, GMC, Pontiac, Ford, Oldsmobile and Saturn

SKU 133621
 27118R **34⁹⁹**

- Fits GM 1999 and Later That Use an O-Ring Seal



Ford, Jaguar and Mazda

SKU 133631
 27247R **34⁹⁹**

- Ford Contour 1998 - 2000, Jaguar XJ8 1998 - Up, Jaguar XK8 1997 - 2006, Mazda Tribute 2001 - Up
- Diameter: 52 mm; Thread Size: 3 mm



Mazda 3, Volvo S40/V50 and Ford Radiator Adapter

SKU 133633
 27249R **34⁹⁹**

- Fits Land Rover LR-2 2008 - Up, Mazda 3 2004 - Up, Volvo S40 and V50 2004 - Up, XC60 2010 - Up, Ford Fusion and Escape 2012 - Up
- Diameter: 50 mm; Thread Size: 2.5 mm



Mercedes and Chrysler

SKU 133626
 27246R **34⁹⁹**

- Fits Mercedes-Benz with Threaded Filler Necks (Except the M-Class 1998 - 2005) and Chrysler Crossfire 2004 - 2008



Ford, Jaguar, Pontiac, Range Rover and SAAB

SKU 133611
 27243R **29⁹⁹**

- Fits Jaguar X Type 2002 - Up, SAAB 900 1994 - 1998, SAAB 9-3 and 9-5 1999 - Up, Some Saturns and Other Vehicles
- Diameter: 52 mm; Thread Size: 3 mm



Import

SKU 695123
 33627112 **45⁹⁹**

- Fits Nissan, Datsun, Mitsubishi, Mazda, Subaru and Toyota Systems
- Also Fits Honda Motorcycles with a 45 mm Cap
- Diameter: 32 mm; Depth: 16 mm



Toyota, Lexus and Scion

SKU 133632
 27248R **34⁹⁹**

- Fits Lexus LS 2007 - Up, Toyota Celica 2000 - Up, Spyder MR2 2000 - Up, RAV4 2009 - Up, Prius 2004 - Up, Camry 2007 - Up, Highlander 2006 - Up and Scion XB 2008 - Up



Volvo, SAAB, Jeep, Maserati and Ferrari

SKU 133600
 27241R **29⁹⁹**

- Fits Maserati and Ferrari Models 2000 - Up, Jeeps with Male Threads 1990 - 1994, SAAB 900 1978 - 1993, SAAB 900 Drop Top 1994, SAAB 9000 1987 - 1998, Volvos with Male Threaded Necks
- Diameter: 45 mm; Thread Size: 3 mm



Audi and VW

SKU 133549
 27240R **29⁹⁹**

- Fits Audi and VW with Male Threads on Filler Neck, Porsche Boxster 1997 - Up, Cayenne 2006 - Up, 911 1999 - Up
- Outside Diameter: 48 mm; Thread Size: 3 mm



Audi and VW

SKU 133625
 27245R **34⁹⁹**

- Fits Audi A4 1996 - Up, A6 1998 - Up, A8 1997 - Up, S4 2004 - Up, TT 2000 - Up, Bentley 2006 - Up, Lamborghini 2006 - Up, Porsche Cayenne 2003 - Up, Porsche Panamera 2010 - Up, Volkswagen Passat 1998 - Up, Beetle 1998 - Up, Golf and Jetta 1999 - Up



VW

SKU 133609
 27242R **29⁹⁹**

- Fits Volkswagens with Female Threaded Filler Necks 1990 - 1998



Fluid Handling Equipment

FluidPRO® ATX-2+Boost Transmission Fluid Exchanger

SKU 573105
 MSS4008000800 **3,799⁹⁹**

- Fully Automatic Operation
- Precision Fluid Measurement to Minimize Technician Input
- Digital Weight Scale Technology for Accurate Fluid Exchange
- Transmission Pressure Diagnostics



Fluid not included

FluidPRO® ATX-3+Boost/PS Combo Power Steering/Transmission Fluid Exchanger

SKU 572537
 MSS4158001900 **4,799⁹⁹**

- PSX-3 Mounted on Back of ATX-3 Machine
- Fluid Flow Direction Indicator Verifies Correct Hook-Up
- Transmission Diagnostic Pressure Gauge
- Process Time: 3 to 6 Minutes Average Full Exchange
- Includes Dipstick Service Mode



Fluid not included

FluidPRO® ATX-3+Boost Transmission Fluid Exchanger

SKU 574434
 MSS4008000900 **4,299⁹⁹**

- 'Dipstick' or 'Cooler' Mode Selector
- Fully Automatic Operation
- Precision Fluid Measurement to Minimize Technician Input
- Digital Weight Scale Technology for Accurate Fluid Exchange
- Transmission Pressure Diagnostics

FluidPRO® MCX-2HD Multi-Coolant System Fluid Exchanger

SKU 575159
 MSS4708003200 **2,799⁹⁹**

- Compatible with All Coolant Types for Adaptability
- Contains Two 15 Gallon New Coolant Tanks and One 15 Gallon Waste Tank Providing Simple, Rapid Switching from One Coolant to Another
- 3 Minute Service Time for Increased Productivity



Fluid not included

FluidPRO® MCX-2 Multi-Coolant System Fluid Exchanger

SKU 574749
 MSS4708003000 **2,499⁹⁹**

- Includes System Pressure Test Feature and "Hot Car" Radiator Cap Pressure Release
- Compatible with All Coolant Types for Adaptability
- Contains Two 7.5 Gallon New Coolant Tanks and One 15 Gallon Waste Tank Providing Simple, Rapid Switching from One Coolant to Another
- 3 Minute Service Time for Increased Productivity

VCX-1 Vacuum Coolant Exchanger

SKU 573048
 MSS4708001900 **2,499⁹⁹**

- Extremely Fast Service Cycles
- Simple Hook-Up and Operation
- Flexible Adaptation for Most Makes and Models



Fluid not included



Mahle FluidPRO® VCX-4 Vacuum Coolant Exchanger

SKU 574376
 MSS4708002000 **3,649⁹⁹**

- Four Transparent, Large Capacity Cylinders; Three for New Coolant and One for Waste
- Easy Coolant Selection/Changeover for Flexible Adaptation of Most Vehicles
- Fast Service Cycles of 5-15 Minutes for Increased Productivity

VFX1 Radiator Coolant Exchanger

SKU 112467
 SYM35010000 **2,899⁹⁹**

- Dual Mode Functionality, In-Line Back Flush or Vacuum Drain-N-Fill
- With the Vacuum Capability, Air Locks are Eliminated Quickly
- Shop Air Operation
- Multi-Fluid Tank Exchange, (2) Interchangeable New Fluid Tanks
- 15 Gallon Used Fluid Tank
- High Efficiency "Engine Off" Flush
- Pressure Check/Vacuum Test
- All Adapters Included



Fluid not included

ATF1 Transmission Fluid Exchanger

SKU 112434
 SYM30110000 **4,599⁹⁹**

- Cooler Line and Dipstick Modes of Operation
- No Co-Mingling of New and Used Fluids
- High Output, Controlled Drainage at 3 Gallons per Minute
- External Mounted Filter for Easy Maintenance
- Adapter Kit Included



Fluid not included

Brake Flush System

SKU 850060
 MSSBFX3 **3,699⁹⁹**

- Three-Step Process Takes Less Than 10 Minutes
- Universal Adapter for Variety of Master Cylinders Included
- Includes Pistol Wand for Convenient and Accurate Fill
- Pressure Gauge to Assist in Brake System Diagnosis



Fluid not included

FluidPRO® PSX-3 Power Steering Fluid Exchange System

SKU 850063
 MSSPSX3 **999⁹⁹**

- Multiple Power Steering Fluid Capability
- Dual Diaphragm-Type Pumps for Speedy Service Times of 5-15 Minutes
- Quick and Easy Changeover Between Different Power Steering Fluid Types Allows Improved Technician Productivity



Fluid not included



FluidPRO® DFX-1 for Differential Fluid Exchange

SKU 572560
 MSS4458000100 **1,299⁹⁹**

- Services All Gear Oils Including Synthetic for Increased Compatibility
- Automatic Operation for Improved Technician Efficiency
- Valved-Hose Ends to Prevent Fluid Spill and Ensure Clean Operation

DIAGNOSTICS

Autel MaxiSys®



MaxiSys® Mini with Connector Kit

SKU 464051
AULMS905K **1,694⁹⁹**

- Powerful Cortex-A9 Quad-Core Processor
- Internal Reliable 32GB SSD for Better Performance and Storage
- Built-In 5-Megapixel Rear Camera with Autofocus and Flashlight
- Dual-Band (2.4 GHz and 5.0 GHz) 802.11n Wi-Fi Automatically Updates Software
- Ergonomic Design Features Strong Rubber Protection and Housing
- Built-In Rechargeable Li-Ion Battery for Up to 5 Hours of Operation



BLUETOOTH COMMUNICATION VCI

MaxiSys® Diagnostic Scan Tool System

SKU 464052
AULMS908 **2,699⁹⁹**

- Powerful Cortex-A9 Quad-Core Processor
- Internal Reliable 32GB SSD for Better Performance and Storage
- Built-In 5-Megapixel Rear Camera with Autofocus and Flashlight
- Dual-Band (2.4 GHz and 5.0 GHz) 802.11n Wi-Fi Automatically Updates Software
- Ergonomic Design Features Strong Rubber Protection and Housing
- Built-In Rechargeable Li-Ion Battery for Up to 8 Hours of Operation



BLUETOOTH COMMUNICATION VCI UPGRADEABLE TO PRO WITH AULMF2534

MaxiSys® Pro Diagnostic Scan Tool System

SKU 543358
AULMS908PRO **3,694⁹⁹**

- Powerful Cortex-A9 Quad-Core Processor
- 9.7" 1,024x768 LED-backlit Glossy Multi-Touch Display with IPS Technology
- Internal Reliable 32GB SSD for Better Performance and Storage
- Built-In 5-Megapixel Rear Camera with Autofocus and Flashlight
- Dual-Band (2.4 GHz and 5.0 GHz) 802.11n Wi-Fi Automatically Updates Software
- Ergonomic Design Features Strong Rubber Protection and Housing
- Built-In Rechargeable Li-Ion Battery for Up to 5 Hours of Operation
- Includes J2534 Reprogramming Device



BJ2534 PASS-THRU PROGRAMMING DEVICE WITH INTERNAL BLUETOOTH VCI

	AULMS905K	AULMS908	AULMS908PRO
Bluetooth Connection VCI	Yes	Yes	Yes
Complete Connector Kit	Yes	Yes	Yes
8" Screen	Yes	No	No
10" Screen	No	Yes	Yes
Key Programming	Yes	Yes	Yes
OE-Level Vehicle Coverage and Diagnostic Functionality	Yes	Yes	Yes
Upgradeable to MaxiSys Pro with J2534	No	Yes, with purchase of AULMF2534 SKU 005455 \$1249.99	Included
Includes 1 Year of Free Software Updates	Yes	Yes	Yes
Additional 1 Year Total Care Package Available	Yes, with purchase of AULMS905-1YRUP SKU 848003 \$689.99	Yes, with purchase of AULMS908-1YR SKU 079901 \$729.99	Yes, with purchase of AULMS908P-1YR SKU 079925 \$1199.99



Heavy Duty MaxiSYS® Diagnostic Tablet

SKU 596888
AULMS908CV **4,694⁹⁹**

- Performs Enhanced System Diagnostics on More Than 60 Commercial Vehicles
- 9.7" LED Capacitive Touch Screen, Android-Based Tablet

- MaxiFlash Elite, Bluetooth Enabled VCI/J2534 Device with WiFi
- WiFi and Bluetooth Enabled Tablet
- Diagnoses Manufacturer-Specific Systems Including Allison Transmissions, Bendix ABS Brake Systems, and Detroit Diesel Engines
- One-Year Software Updates



NEW

Autel TPMS Tools

READS / WRITES SENSOR IDS

MaxiTPMS® TS501K Diagnostic and Service Tool with 8 TPMS Sensors (Sensors \$319.00 Value)

SKU 850650
AULTS501K **549⁹⁹**

BETTER

SHOWS TPMS LIVE DATA

MaxiTPMS® TS601 All-In-One TPMS Tool with OBDII

SKU 376934
AULTS601P **959⁹⁹**

BEST

315MHz / 433MHz Universal Programmable MX-Sensors

- Built to Perform Like OE Sensors in Terms of Signal, Durability and Functionality
- Robust Clamp-In Pivoting Stem Design Allows for 0-35 Degree Angle Adjustment to Fit All Wheels Types
- 2 SKU Sensor Solution Covers 98% of All OE Sensors

Metal Tip Sensors

SKU 080038
AULMXSENS315M 315MHz **39⁹⁹**

SKU 080039
AULMXSENS433M 433MHz **39⁹⁹**

Rubber Sensors

SKU 290274
AULMXSENS315R 315MHz **31⁹⁹**

SKU 290286
AULMXSENS433R 433MHz **33⁹⁹**

MaxiTPMS® Pads

SKU 526852
AUL101000017 **69⁹⁹**

- Make MX-Sensor Programming Easy in 3 Simple Steps

- Direct Reading from Sensor for Quick Programming
- No Need for Vehicle Relearns
- Ideal for Mechanically Broken Sensors
- Automatically Creates ID Numbers Compatible with the Vehicle
- Runs from PC USB Power, No Batteries Required



	AULTS501K	AULTS601P
Activate Sensors and Retrieve Data	Yes	Yes
Display Relearn Procedures	Yes	Yes
Step-by-Step Graphic Direction for OE Relearn Procedures	Yes	Yes
Autel MX Sensor Programming Capabilities	Yes	Yes
OBDII Interface to Extract TPMS Codes	Yes	Yes
Detect and Display TPMS System Faults	Yes	Yes
Read and Clear TPMS Information	Yes	Yes
Complete TPMS System Diagnostics	No	Yes
Live TPMS Data Stream	No	Yes
Adjust Tire Size Placard Values	No	Yes
Receives Both 315MHz and 433MHz Sensors	Yes	Yes
Includes 6 Metal Stem and 2 Rubber Stem Sensors	Yes	No

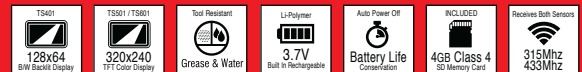

AUTEL®

MAXISYS™

FEATURES COMPARISON CHART

BUILT-IN COMPLETE TPMS FUNCTIONALITY

AULMS906TS SKU 288495

- INCLUDES SAME MS906 FEATURES PLUS:
- EMBEDDED TPMS ANTENNA TRIGGERS ALL KNOWN SENSORS / CLONE & PROGRAM AUTEL MX-SENSORS
- COMPLETE TPMS SYSTEM DIAGNOSTICS
- TPMS SYSTEM STATUS SCREEN TO IDENTIFY FIXES
- DOUBLE THE BATTERY SIZE OF THE MS906
- OPTIONAL ACCESSORIES - MAXISCOPE / MV105 / MV108



1,949.99

WIRELESS BLUETOOTH OBDII CONNECTOR

AULMS906 SKU 040101

- COVERS US / ASIAN / EUROPEAN VEHICLES
- INSTANTLY RETRIEVES VEHICLE INFO
- OE-LEVEL VEHICLE COVERAGE & FUNCTIONS
- DETECT & DISPLAY FAULTS & TROUBLE CODES
- LIVE DATA VIEW / PRINT / STORE / PLAYBACK
- DEDICATED SERVICES SECTION - OIL SERVICE RESET, TPMS RELEARN, EPB, ABS/SRS, SAS
- FULL-SCREEN WAVEFORM GRAPHING ANALYSIS WITH TRIGGER-TYPE RECORDING MODES



1,494.99

TETHERED CABLE OBDII CONNECTOR

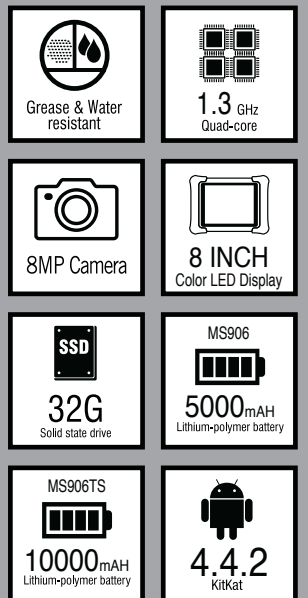

AUTEL.COM UPDATES PROVIDE THE LATEST TPMS DIAGNOSTIC COVERAGE, OE LEARNING PROCEDURES AND THE ABILITY TO CLONE AND PROGRAM AUTEL MX-SENSORS

1 YEAR WARRANTY / 1 YEAR FREE SOFTWARE UPDATES



Contact Us:
1-877-AZTool1 Phone
 (1-877-298-6651) *Hablamos Español*

**WE SELL
 HEAVY DUTY TOOLS
 AND EQUIPMENT**

Look for These Brands



See Page 20

Autel Diagnostic Tools

AutoLink® OBDII/CAN Code Reader with Color Screen

SKU 222492 **49⁹⁹** REG. \$59.99
 AULAL319

SAVE \$10

Reads Live Data

- Bright Color Coded LEDs and Built-In Speaker
- Retrieves Generic, Manufacturer Specific, and Pending Codes
- Determines the Cause of the Malfunction Indicator Light
- Turns Off Malfunction Indicator Light, Clears Codes and Resets Monitors
- Displays DTC Definitions on the TFT Color Screen
- Views Freeze Frame Data
- Displays Monitor and I/M Readiness Status



Offer Good Through June 30, 2017 - While Supplies Last

Diagnoses All 1996 and Newer OBDII Compliant Vehicles

AutoLink® OBDII/EODB Scan Tool

SKU 222488 **99⁹⁹**
 AULAL419

- Features Patented 1 Click I/M Readiness Key
- Troubleshooter Code Tips Guide Technicians
- Prints Data Via PC
- Bright Color Coded LEDs and Built-In Speaker
- Retrieves Generic, Manufacturer Specific, and Pending Codes
- Determines the Cause of the Malfunction Indicator Light
- Turns Off Malfunction Indicator Light, Clears Codes and Resets Monitors
- Displays DTC Definitions on the TFT Color Screen
- Retrieves VIN, CIN, and CVN Information
- Internet Updateable and Upgradeable



AutoLink® Enhanced OBDII Scan Tool

SKU 222483 **124⁹⁹**
 AULAL519

- Enhanced OBDII Mode 6
- Features Patented 1 Click I/M Readiness Key
- Troubleshooter Code Tips Guide Technicians
- Prints Data Via PC
- Bright Color Coded LEDs and Built-In Speaker
- Retrieves Generic, Manufacturer Specific, and Pending Codes
- Determines the Cause and Resets the Malfunction Indicator Light
- Displays DTC Definitions on the TFT Color Screen
- Retrieves VIN, CIN, and CVN Information



AutoLink® OBDII and Electrical Test Tool

SKU 222487 **149⁹⁹**
 AULAL439

- AVO-Meter Reads Voltage and Resistance
- Capable of Diagnosing 12V Charging and Starting Systems
- Features Patented 1 Click I/M Readiness Key
- Prints Data Via PC
- Bright Color Coded LEDs and Built-In Speaker
- Retrieves Generic, Manufacturer Specific, and Pending Codes
- Determines the Cause and Resets the Malfunction Indicator Light
- Retrieves VIN, CIN, and CVN Information
- Internet Updateable and Upgradeable



AutoLink® Enhanced OBDII and Electrical Test Tool

SKU 222509 **159⁹⁹**
 AULAL539

- Reads Live PCM, O2 Sensor Test, and Freeze Frame Data
- Visually Graphs Data (1996 and Newer)
- AVO-Meter Reads Voltage and Resistance
- Capable of Diagnosing 12V Charging and Starting Systems
- Features Patented 1 Click I/M Readiness Key
- Prints Data Via PC
- Bright Color Coded LEDs and Built-In Speaker
- Retrieves Generic, Manufacturer Specific, and Pending Codes
- Determines the Cause and Resets the Malfunction Indicator Light
- Retrieves VIN, CIN, and CVN Information
- Internet Updateable and Upgradeable



AutoLink® OBDII, CAN, ABS, and SRS Scan Tool

SKU 227784 **199⁹⁹**
 AULAL619

- Analyzes ABS/SRS System Codes
- Reads, Stores, and Plays Back Live PCM Datastream and Sensor Data
- Visually Graphs Data
- Prints Data Via PC
- Retrieves Generic, Manufacturer Specific, and Pending Codes
- Diagnoses and Resets the Malfunction Indicator Light and ABS/SRS Warning Lights
- Retrieves VIN, CIN, and CVN Information
- TF Memory Card for Data Backup and Software Update



MaxiCheck® Pro Diagnostics Scan Tool for EPB, ABS, SRS, SAS, and TPMS

SKU 222473 **439⁹⁹**
 AULMAXICHECKPRO

- Crystal Clear TFT Color Screen
- USB Internet Updateable and Upgradeable
- Opens and Closes Electronic Brake Calipers
- Reads and Clears EPB/SBC Trouble Codes
- Turns Off the ECU and Brake Warning Lights
- Diagnoses EPB/SBC Caliper Functionality
- Resets the Oil Service Light, Service Mileage, and Service Intervals
- Resets Steering Angle Sensors (SAS)
- ABS and SRS Coverage for 50+ Vehicle Makes - U.S. Domestic, Asian and European
- Reads, Records and Plays Back OBDII Live Data Graphing



8.5mm MaxiVideo Inspection Camera

SKU 079977 **119⁹⁹**
 AULMV108

- 8.5 mm (0.22") Diameter Image Head
- Flexible Imager Head and Cable Reach to 3.3'
- Adjustable, White LED Illuminates Inspection Area
- Waterproof Head and Cable to 10'
- USB Compatible
- Includes Magnet, Mirror, Hook Attachments



5.5mm MaxiVideo Inspection Camera

SKU 079943 **139⁹⁹**
 AULMV105

- 5.5 mm (0.22") Diameter Image Head



1 Year Update for MaxiSYS® Mini MS905

SKU 848003 **689⁹⁹**
 AULMS905-1YRUP

1 Year Update for MS908

SKU 079901 **729⁹⁹**
 AULMS908-1YR

1 Year Update for MS908P

SKU 079925 **1,199⁹⁹**
 AULMS908P-1YR



Scan Tools



Code Buddy PRO OBDII Code Scanner

SKU 802332 **79⁹⁹**
 ES1903

- Reads Live Data Stream
- Works on All 1996 and Later OBDII Compliant US, European and Asian Vehicles
- Clears Codes, Turns Off MIL and Resets Monitors
- Built-In OBDII Fault Code Lookup Library



iOBDII Code Reader

SKU 462982 **99⁹⁹**
 CDOIOBD2

- Works for Both iPhone and Android Phones and Communicates via Bluetooth®
- Read and Clear Codes
- Read and Record Live Data Stream
- Read Freeze Frame Data, Vehicle Information
- O² Sensor Testing
- Mode 6 Testing
- Evaporative Emission System Leak Detection
- Customizable Dashboard
- Includes Many Features Not Available or Cost Extra on Other Bluetooth OBDII Adapters

Wirelessly Connects to Either iPhone® or Android™ Smart Phones and Tablets via Bluetooth®



*Phone Not Included

CanDo Battery Reset Tool

SKU 572412 **149⁹⁹**
 CDOCDBATTBMC

- Perform Battery Resets on: BMW/Mini, VW/Audi, Jaguar, Land Rover, Ford and More

Some New Vehicles Require a Scan Tool to Reset the Battery Life in the Vehicle's Computer When Replacing the Battery. Failure to Do So Can Cause Over-Charging, Shorten the Battery Life and/or Enable Limp-Home Mode and Even a No-Start Situation.

The CanDo Battery Reset Tool is Reliable, Affordable and Easy to Use.



DID YOU KNOW?

AutoZone® offers ALLDATA® diagnostic software.

Contact Your AutoZone Commercial Sales Manager for Pricing

Brake, Oil and Service Light Reset + Tool

SKU 793568 **245⁰⁰**
 33627302

- Used to Reset Oil Service Light, Service Mileage, Service Intervals, Vehicle Inspection, Engine Oil, Front and Rear Brake, Brake Fluid, Dust Filter and Spark Plugs on Most Major Asian, American and European Vehicles
- Easy, Step-by-Step On-Screen Instructions
- Automatic or Manual Reset Option
- Includes USB Cable and OBDII Connectors
- Comes in a Blow Mold Case



Full Color Heavy Duty Truck Code Scanner with Caterpillar Coverage and OBDII

SKU 344832 **449⁹⁹**
 CDOHDCODEII

- Includes CAT Power Equipment, CAT Construction and CAT Industrial, International, Hino, Isuzu and Hybrid HD Trucks Plus OBDII Vehicles
- Access Engine, Transmission and Brakes
- Read/Clear Codes
- View/Graph Live Data

Extensive Class 4-8 HD, Medium and Light Duty Truck and Caterpillar Coverage



DIAGNOSTICS

DLA+ 2.0 Adapter Kit

SKU OUTSIDE BUY/EPO
NRS122061

699⁹⁹

- Includes: DLA+ 2.0 Adapter
- Vehicle Cables (9-Pin and 6-Pin Cables for 3 CAN Support)
- Cables for Medium-Duty Applications: Ford, GM, Sprinter
- USB Computer Cable
- Adapter Kit Carrying Case

Available via
Outside Buy/EPO,
Call 1-877-298-6651 for
ordering instructions.



Trailer Diagnostic Adapter with Power Cable

SKU OUTSIDE BUY/EPO
NRS122511

699⁹⁹

- Required to Test, Diagnose, and Initiate Repair on a Heavy-Duty Trailer ABS
- Allows Connection Directly to Trailer Using Secondary Power Source
- Includes: Noregon Trailer Diagnostic Adapter
- 7-Pin J560 T-Connector Cable
- 15' USB Computer Cable
- Adapter Carrying Case

Available via
Outside Buy/EPO,
Call 1-877-298-6651 for
ordering instructions.



JPRO® Professional Diagnostic Software and Adapter Kit with Next Step™

SKU OUTSIDE BUY/EPO
NRS232125-NS

3,249⁹⁹

- JPRO Professional Diagnostic Software (Annual Subscription)
- Next Step Service Information
- DLA+ 2.0 Adapter
- Type-2 Vehicle Cables (6-Pin, 9-Pin)
- Type-B OBDII Cables (Ford, GM, Sprinter, Mack and Volvo)

Connects Heavy
Duty Vehicles to
a PC via USB Port
for Diagnostics,
Reprogramming or
Parameter Adjustment

Available via
Outside Buy/EPO,
Call 1-877-298-6651 for
ordering instructions.



JPRO® Professional Diagnostic Toolbox + Next Step™

SKU OUTSIDE BUY/EPO
NRS263025-NS

4,899⁹⁹

- JPRO Professional Diagnostic Software (Annual Subscription)
- Next Step Service Information
- Panasonic® Toughbook® CF-53
- DLA+ 2.0 Adapter
- Type-2 Vehicle Cables (6-Pin & 9-Pin)
- Type-B OBDII Cables (Ford, GM, Sprinter, Mack and Volvo)
- USB Cable

Available via
Outside Buy/EPO,
Call 1-877-298-6651 for
ordering instructions.



INNOVA PRO

CarScan Code Reader™

sku: 514004
INN30203

54⁹⁹

CarScan Diagnostic Tool™

sku: 509778
INN31003

149⁹⁹

CarScan + OBD1

sku: 504203
INN31403

299⁹⁹

ABS/SRS + OBD2® Scan Tool

sku: 504259
INN31603

159⁹⁹

CarScan + OBD1 & SRS/ABS

sku: 504457
INN31703

264⁹⁹



Now Offering
BONUS
ABS SRS
Asian and European
Upgrades to the
31603 & 31703

\$199 Value

Offer Good Through June 30, 2017 - While Supplies Last

Features and Functions

	30203	31003	31403	31603	31703
1996 - Present (OBD2 Compliant) - Domestic, Asian and European	■	■	■	■	■
CAN and 2010+ Model Diesel and Hybrid Compliance	■	■	■	■	■
Patented All-in-One Display Shows 20+ Values on One Screen	■	■	■	■	■
Vehicle Health Monitor LED's - Confirm Safe Emissions Test	■	■	■	■	■
Emissions Readiness Advisor - Complete OBD Trip + Drive Cycles	■	■	■	■	■
VIN# Decoder - Detailed Vehicle Identification for Quick Diagnostics	■	■	■	■	■
Retrieve Manufacturer Specific, Global and Pending Codes	■	■	■	■	■
Erase Button Turns Off "Check Engine" Light	■	■	■	■	■
Customer Service - Mon-Sat, 6am- 6pm, PST - English/Spanish	■	■	■	■	■
Vehicle Information - VIN # - Mode 9	■	■	■	■	■
Multilingual - On Screen Definitions in English/Spanish	■	■	■	■	■
Battery Backup for Off Vehicle Data Review	■	■	■	■	■
Displays Freeze Frame Data	■	■	■	■	■
OBD2 Live-Data Stream Display	■	■	■	■	■
RepairSolutions® with VIN Specific Fixes and Procedures - Optional	■	■	■	■	■
Internet Updateable and Upgradeable	■	■	■	■	■
Enhanced Engine and Transmission Codes	■	■	■	■	■
OBD2 - All 10 Modes	■	■	■	■	■
Record, Graph and Play Back OBD2 Live Data on Tool	■	■	■	■	■
ABS/SRS Most 1996-08 GM, Ford, Chrysler, Toyota, Honda DTC's			Optional	■	■
OBD1 - Ford, GM, Chrysler, Toyota, Honda DTC's			■	Optional	■
Shop Management Software - Print and Manage Vehicle Diagnostic Reports			■	■	■
ABS Asian and European			■	■	■
SRS Asian and European			■	■	■

TechPRO®

To make the challenging job of diagnosing and servicing today's computer-controlled engines easier and more efficient, we've developed the world's SMARTest diagnostic tool: the MAHLE TechPRO Diagnostic Scan Tool. The most advanced technology available for professional technicians, this versatile, PC- or tablet-enabled tool will help you analyze, diagnose and repair today's sophisticated vehicles faster and more accurately than ever before. No more waiting for automakers to send monthly or annual updates!

Automotive Diagnostic System (Includes VCI1000 and 1-Year Subscription)

SKU 080045
MSS402800100

1,599⁹⁹

VCI1000 SYSTEM Plus 8" Tablet with Preloaded Software

SKU 080072
MSS4028000400

1,999⁹⁹

VCI1000 SYSTEM Plus 10" Tablet with Preloaded Software

SKU 080027
MSS4028000600

2,299⁹⁹

MAHLE
Driven by performance

TechPRO®



Inspection Cameras

Borescope with 2.4" Color LCD Screen

SKU 544746
24383

129⁹⁹ REG. \$149.99

- Resolution: 640 x 480
- Adjustable LEDs illuminate the inspection area
- 9 mm Probe
- 1 Meter Flexible Shaft
- Includes: Magnet, Mirror and Hook; All in a Blow Mold Case

Offer Good Through June 30, 2017 - While Supplies Last



OEM TOOLS

SAVE
\$20

2.7" LCD Inspection Camera

SKU 813284
W50046

159⁹⁹

- Full Function Camera with Video Playback/Record and 180° Image Rotation
- Submersible 11/32" (9 mm) Diameter Camera with 640 x 480 Resolution
- 4 White LEDs with 6 Output Levels
- 40" (1 M) Flexible Neck
- 32 MB Built-In Memory, Micro SD Card Slot and TV/Video Output Jack



PT
Performance Tool

2.4" LCD Inspection Camera

SKU 802203
AZ5004

109⁹⁹

- 2.4" Color LCD Monitor with 320 x 240 VGA Resolution and 180° Image Rotation and Mirroring
- Submersible 11/32" (9 mm) Diameter Camera with 640 x 480 Resolution
- 4 White LEDs with 6 Output Levels
- 40" (1 M) Flexible Neck
- TV/Video Output Jack



STORE STOCK
Duralast

MaxiVideo® MV208-8.5 Digital Videoscope

SKU 222475
AULMV208-8.5

139⁹⁹

- 2.4" Hi-Res Color LCD Display (320 x 240)
- Easy-to-Use, Multi-Language Interface
- Wide Camera Angle with 640 x 480 Resolution
- Probe Diameter of 8.5 mm



AUTEL
AUTOMOTIVE INTELLIGENCE

MaxiVideo® MV208-5.5 Digital Videoscope

SKU 255816
AULMV208-5.5

159⁹⁹

- 2.4" Hi-Res Color LCD Display (320x240)
- Easy-to-Use, Multi-Language Interface
- Wide Camera Angle with 640 x 480 Resolution
- Probe Diameter of 5.5 mm



AUTEL
AUTOMOTIVE INTELLIGENCE

MaxiVideo® MV400-5.5 Digital Videoscope

SKU 222477
AULMV400-5.5

199⁹⁹

- 3.5" Hi-Res Color LCD Display (320 x 240)
- Removable SD Card for Images and Video
- Easy-to-Use, Multi-Language Interface
- Wide Camera Angle with 640 x 480 Resolution
- Probe Diameter of 5.5 mm



AUTEL
AUTOMOTIVE INTELLIGENCE



Contact Us:
1-877-AZTool1 Phone
 (1-877-298-6651) *Hablamos Español*

Smoke Leak Detectors

SmokePro® Tech-Mate Plus™
 SKU 543388
 RED95-0007A **749⁹⁹**

- (1) Smoke Pro Tech-Mate Plus
- (1) OEM-Approved Smoke Agent
- (1) Halogen Inspection Light
- (1) EVAP Service Port Tool
- (1) EVAP Schrader Valve Removal Tool
- (1) Cap Plug Kit
- (1) Exhaust Cone Adapter
- (1) Plastic Accessory Case
- Online Training Videos Provided



SmokePro® Master Tech Pack™
 SKU 250694
 RED95-0019B **1,199⁹⁹**

- Speed Up Diagnostics, Improve Accuracy in Repairs, Heighten Customer Satisfaction and Increase Profits
- Minimum Leak Detection: 0.010"
- Operating Modes: Air-Only Cycle - Smoke Cycle
- Includes: (1) Smoke Pro Total Tech, (1) Hook, (1) Hex Key, (3) OEM-Approved Smoke Agent, (1) EVAP Service Tool Kit, (1) Halogen Inspection Light, (1) Cap Plug Kit, (2) Standard Cone Adapter, (1) Plastic Storage Case, (1) Universal Filler Neck Connector, (2) Sealing Disks, (1) Smoke Output Hose



Smoke Diagnostic Machine
 SKU 544732
 24534 **649⁹⁹** REG. \$699.99

- Helps Technicians Diagnose Trouble Codes on Domestic and Import Cars and Light-Trucks
- Tests for Oil Leaks, Wind Leaks, EGR Leaks and More
- Finds Leaks Fast
- Includes Variable Flow Control and Integrated Regulator That Detect Leaks in the System with Smoke
- Works for Turbo Systems, Engine Block, Fuel System and Exhaust Systems
- 12 Volt with Automatic Off Switch
- Works with Standard Mineral Oil



SAVE \$50

Offer Good Through June 30, 2017 - While Supplies Last

Smoke Producing Fluid (8 Oz.)

SKU 802333
 RED96-0039 **19⁹⁹**

- Contains No Dye or Other Contaminants
- Works in Most EVAP Smoke Machines



Intake Inflatable Block Off Bladder for Use with All Smoke Machines

SKU 598247
 24536 **99⁹⁹**

- Can Be Used with Any Brand of Smoke Machine or Diagnostic Leak Detector
- Conforms to Any Shape Intake / Exhaust: Square, Round, Oval or Rectangular
- Can Be Used with Any Brand of Smoke Machine or Diagnostic Leak Detector
- Works with Most Automobiles and Light, Medium and Heavy-Duty Truck Valves



EasyEVAP™ Universal Filler Neck Connector

SKU 343405
 RED95-0030 **159⁹⁹**

- Compatible with Any Smoke Machine and Removes Cleanly from the Gas Cap
- Essential Tool for Late Model Cars with Fuel Tank Rollover Valves



Fuel and Engine

Exhaust Back Pressure Tester/Gauge

SKU 347232
 27263 **59⁹⁹** REG. \$69.99

- Oxygen Sensor Adapter is M12 and M18 Thread
- 6" Hose Allows User to Test from Driver's Seat
- Test for Restricted Exhaust Systems
- Comes in a Blow Mold Case



SAVE \$10

Offer Good Through June 30, 2017 - While Supplies Last

Oil Pressure Gauge Set

SKU 347229
 27262 **79⁹⁹**

- For Use on Diesel and Gasoline Engines
- Includes Standard and Metric Adapters Found on Most Cars and Trucks
- 2-1/2" Easy-to-Read Gauge with Protective Boot
- Comes in a Blow Mold Case



Cylinder Leak Down Test Kit

SKU 347237
 27267 **159⁹⁹**

- Includes: Precision Regulator with a Combination M14/M18 Adapter; 26" Hose M10, M14 and M18 Solid Long Reach Adapters; and Extra O-Rings
- Displays Leakage as a Percentage
- Comes in a Blow Mold Case

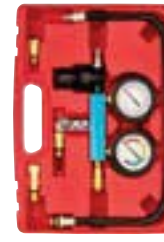

Fuel Pressure Test Kit

SKU 347235
 27265 **109⁹⁹** REG. \$159.99

- Designed Around Quick Connect Adapters
- Includes 3-1/2" Heavy Duty Gauge with Protective Boot, Large and Small Schrader Adapters, MG-1.00 Banjo Adapter, Double End Tee for 5/16" and 3/8" and Single End Connector for 1/4", 5/16" and 3/8"
- Range: 0 - 150 PSI
- Comes in a Blow Mold Case



SAVE \$50

Offer Good Through June 30, 2017 - While Supplies Last

Fuel Injection Cleaner Kit

SKU 517582
 MITMV5567 **419⁹⁹**

- Complete Fuel Injector Cleaning Kit Combining the Cleaner with Connection Hose (MV5565) and Connection Adapter Kit (MVA565)
- Can Be Upgraded to an Air Induction Cleaner by Adding MVA550 Decarb Nozzle
- Quickly and Cleanly Removes and Prevents Fuel Injector Deposits, and Loosens and Dissolves Carbon on Intake Manifold and Valves
- Enhances Engine Performance, Improves Fuel Economy, Reduces Maintenance and Improves Emission
- Uses Standard Shop Air to Deliver Cleaning Solution Directly Into the Fuel Stream or Spray it Into the Air Induction System (MVA550 Required for Induction System Cleaning)



Fuel Pressure Test Kit

SKU 988887
 MITMV5546 **449⁹⁹**

- Contains (37) Adapters for Pressure Testing Most US, Asian and European Manufactured Vehicles
- High Quality, Heavy Duty Gauge with 0 - 120 PSI (0 - 8 Bar) Scale, Protective Rubber Boot and Push Button Pressure Relief Valve
- Uses SAE Certified, Fuel-Rated Quick Connects for Reliability, Ease of Use and Interchangeability
- Easily Upgrades to a Fuel Pressure and Flow Tester with the Addition of Flow Meter Upgrade Kit MVA5553



Fuel System Tester

SKU 988886
 MITMV5545 **634⁹⁹**

- Measures Fuel System Pressure and Flow to Accurately Pinpoint Fuel System Failures
- Saves Hours of Troubleshooting Time by Diagnosing a Bad Fuel Pump and Other Related Drive Ability Problems in Seconds
- Patented System Simulates Extreme Driving Conditions in the Shop to Provide the Most Accurate Diagnosis
- Capable of Testing Both Return and Returnless Fuel Systems Including Electronic Control
- Provides Clear Visualization of Fuel to Detect Impurities and Air Bubbles



Diagnose and Pinpoint Common Fuel System Failures Including: Failing Fuel Pump, Faulty Pressure Regulator, Blocked Filter(s), Pinched Fuel Line, Contaminated Fuel and Fuel Tank Vortex.

Compression Testers

Professional Compression Test Kit

SKU 972276
 MITMV5530 **84⁹⁹**

- Adapters Include: 10, 12, 14 and 18 mm
- Extended Hoses for Hard-to-Reach Cylinders
- Large 2-3/4" Easy-to-Read Gauge
- Quick Disconnect Fittings

Everything You Need to Perform Cylinder Compression Tests on Motorcycles, Marine and Small Engines, and an Air-Hold Adapter for Performing Valve Seal Repairs



Master Compression Test Kit

SKU 347236
 27266 **149⁹⁹**

- Includes: 2-1/2" 0 - 300 PSI Gauge with 10" Hose, Quick Connect and Protective Boot, Plus 1-1/2" 0 - 200 PSI Gauge for Small Engines
- (2) Separate M14 Hoses, (Short Thread and Long Thread) M18 Hose, M10, M12 and M18 Solid Adapter
- Extra O-Rings and Valve Cores Included
- Comes in a Blow Mold Case



Digital Gas Engine Compression Test Kit

SKU 383182
 MITMV5532 **154⁹⁹**

- Stores Maximum Compression Value for Up to 12 Cylinders
- 3 Minute Auto Shut-Off
- Sealed, Grease and Oil-Resistant Gauge Face Prevents Contamination of Electronics
- Displays Values in PSI, Bar and kPa



Digital Diesel Compression Test Kit

SKU 988885
 MITMV5535 **274⁹⁹**

- Features an Electronic Tester That Memorizes Peak Values for Each Cylinder
- Injector Adapter: Dodge 24V 5.9L Cummins (1999-2003); Dodge 5.9L Cummins ISB and ISBE; Case/ Cummins Series "B" 2.9L, 3.9L, 5.9L (Through 1998)
- Glow Plug Adapters: GM 4.3L, 5.7L (1978-1985); Navistar 6.9L, 7.3L (Through 1994); GM 6.2L, 6.5L V8; Ford/Navistar 7.3L Power Stroke (1994-2003); Volkswagen 1.9L TDI
- Right-Angle Adapter



Diesel Glow Plug Adapter

SKU 420348
 MITMVA5611 **59⁹⁹**

- Applications include: GM Duramax 6600, Isuzu 6.6L
- Glow Plug Adapter - M10 x 1.0



Ford 6 Liter Adapter

SKU 972279
 MITMVA5610 **29⁹⁹**

- Glow Plug Adapter M14 x 1.25
- International VT365
- Ford Power Stroke, 6.0 Liter Engine



DIAGNOSTICS

Labscope

Dual Channel Labscope

SKU 094926
UEIADL7103 **1,399⁹⁹**

- Digital Storage Oscilloscope
- Graphing Multimeter OBDII Code Reader
- Sample Rate 25 Meg per Second
- 51 Preset Waveforms That Include Sensor, Actuator, Electrical and Ignition Patterns
- DC to 5Mhz Bandwidth
- Secondary Ignition Displays the Waveform and Includes Spark Voltage, RPM, Burn Time and Burn Voltage
- Parade Pattern on Secondary Ignition "Parade" Mode
- Built-In "Help" Includes Test Procedure
- Includes USB Software to Capture Screen Images



Glow Plug Reader

Glow Plug Reader

SKU 531174
CDOGPR **219⁹⁹**

- Uses a Resistance Test with Diagnostic Algorithms to Provide an Accurate Diagnostic Result
- No Voltage Applied, Preventing Damage to Expensive Components
- Tests All Plugs Up to 24V On or Off the Car
- Results with Actual Condition Displayed on Backlit Digital Display
- Built-In LED Flashlight for Testing in Low Light Conditions



Probes

Electrical Back Probe Kit

SKU 511020
THX490 **34⁹⁹**

- Kit Contains 20 Pin-Type Back Probes
- Smaller Pins for Tough-to-Test Areas
- Color Coded for Easier Testing



Extended Heavy Duty Back Probe Kit

SKU 511028
THX490X **39⁹⁹**

- Contains 8 Extended Electrical Back Probes
- Use to Access Electrical Circuits from the Back Side of the Connector
- Color Coded in 4 Variations for Easier Testing



Heavy Duty Electrical Back Probe Kit

SKU 511021
THX490-M **39⁹⁹**

- Have Longer Pin for Tough-to-Reach Circuits
- Kit Contains: (10) Straight Pins, (5) 90 Degree Pins, (5) 45 Degree Pins
- Color Coded for Easier Testing



Electrical Diagnostic Test Kits

Power Probe III with Case and Accessories

SKU 262523
PWPPP319FTC **169⁹⁹**

- Relay and Component Tester
- Voltmeter and Continuity Tester
- Audio Tone
- Carbon Fiber Design Housing
- 20' Jumper Lead
- Works on 12-24V Sources



ECT3000 Short/Open Electrical Circuit Tester

SKU 598789
PWPPPECT3000 **199⁹⁹**

- Transmitter Will Quickly Determine an Open or Short Circuit When Connected to an Isolated Circuit
- Receiver is Designed to Detect the Signal Emitted from the Transmitter Through the Vehicle's Wiring, Notifying the User of Distance and Direction with Adjustable Height Sensitivity
- 10 Minute Auto Shut-off
- Integrated Flashlight in Receiver



Power Probe IV

SKU 802331
PWPPP401AS **229⁹⁹**

- Supplies Power and Ground for Functional Component Testing
- Digital Volt and Ohmmeter for Circuit Testing
- Large Color LCD Screen with Easy to Navigate User Menu
- AC-RMS, AC Peak to Peak, Frequency and Pulse Width for Signal Testing
- Fuel Injector Tester for Easy Circuit Diagnosis
- PCM/ECM Driver Supplies Safe Voltage for Testing Circuits



Master Electrical Test Kit

SKU 262524
PWPPPKIT03 **369⁹⁹**

- Includes: Power Probe III, ECT2000 and Gold Series Lead Set
- Contains Gold Series 4 mm Leads and Connectors
- Continuity, Relay and Component Tester
- Works on 12-24V Sources
- Easy-to-Read Backlit Voltmeter Reads Voltage in 1/10th Volt



Relay Circuit Tester

SKU 383450
27211 **139⁹⁹**

- Includes: Tester, (5) Popular Relay Leads, (1) Universal Relay Lead
- Use to Test Relay Circuits in Late Model Vehicles
- Can Also Be Used to Perform Easy Combination Tests, Fuel Pressure Tests and Jump Relay for A/C Fill
- Comes in a Blow Mold Case



Multi-Function Power/Ground Meter

SKU 300126
24366 **79⁹⁹** REG. \$149.99

- Quickly Diagnose Circuits and Test Components
- Apply Battery Voltage or Ground with a Simple Thumb Rocker Switch
- Performs Standard Multimeter Functions: Volt, Continuity and Polarity
- Includes: Meter, 20' Extension Lead, Probe Extension, Battery Clips, Cigarette Lighter Adapter, Auxiliary Ground Lead



SAVE \$70

MEASURE SPARK KV, INJECTOR FREQUENCY AND PULSE

Comes in a Blow Mold Case



Offer Good Through June 30, 2017 - While Supplies Last

Multimeters

Parasitic Drain Tester

SKU 011608
LIS64970 **24⁹⁹**

- Replaceable In-Line Fuses
- Allows Tester and Meter to Remain Connected
- Stacking Banana Connectors



Auto-Ranging Digital Multimeter

SKU 851885
ESI480A **54⁹⁹**

- 43 Test Ranges, Auto-Ranging
- 10 Test Functions
- Auto Power-Off, Data Hold
- Dual Fuse Protection
- 10 Meg/Ohm Input Impedance



Deluxe Automotive Digital Multimeter with Carrying Case

SKU 301604
ESI585K **119⁹⁹**

- Used for Diagnosing Electrical, Computer and Engine Problems
- 45 Test Ranges, 14 Test Functions, and Dual Fuse Protection
- RPM for DIS and Standard Ignitions
- RPM Pick-Up and Temperature Probe Included
- Dual Fuse Protection with Built-In Tilt Stand
- Dual Display with Analog Bar Graph and Digital Readings



Current Probe/Multimeter

SKU 489181
ESI685 **199⁹⁹**

- 35 Test Ranges with Continuity Beep
- 10 Test Functions with Overload Protection
- Heavy Duty Insulation Piercing Clips
- Automatically Powers Off
- Clamp Opening of 7/8"
- Carrying Case and 9 Volt Battery Included



Timing Lights

Professional Timing Light

SKU 108154
INN5568 **149⁹⁹**

- Four Function Digital Readout and Easy-to-Read Backlit LCD
- Tachometer: 249 to 9,990 RPM
- Advance Degrees (2 and 4 Cycle): 0° to 90°
- Dwell: 0° to 180° 2-12 Cylinders
- Voltage: 10 to 16 Volts DC
- Switches from 2 Cycle to 4 Cycle
- Heavy Duty ABS/Polycarbonate Shockproof Housing, Molded Boots, Built-In Hand Guard for Protection
- Detachable 6' Leads with Metal Inductive Pickup
- Patented Skip Circuitry Test Up to 9,990 RPM



Reprogrammer

CarDAQ-M®

SKU 222849
DRWCARDAQ-M **1,899⁹⁹**

- High Performance J2534-1 Product for Reprogramming All Makes
- Technicians Can Use CarDAQ-M for Security Key Systems/ Programming on Ford, GM and Toyota Vehicles
- Kit Includes a J2534-1 and J2534-2 Module, OBDII Cable, USB Cable, CD and User's Manual
- Ability to Add Extra CAN Channels, K-Line Channels, and Wireless Connectivity



Truly Universal Device, Educational Materials and Technical Support Included

CarDAQ-Plus® J2534 Flash Reprogramming Kit

SKU 362551
DRWCARDAQPLUS **1,679⁹⁹**

- Provides Both Ethernet and USB Connectivity to a PC
- Built-In Operating System for Running Internal Programs
- Protocol Support for Modern Vehicles
- 6 Analog Inputs
- Upgradeable Through Firmware Updates and Expansion Slots
- ECU Programming (ECM, PCM, TCM, BCM, Etc.)
- Generic and OEM-Level Diagnostics
- Key Programming
- VIN Read/Write
- SKIM Clear/Reset
- Immobilizer Adaptation
- Data Monitoring



MongoosePro® Vehicle Interfaces

Chrysler
SKU 362554
DRWMGSCI **499⁹⁹**

Ford
SKU 362553
DRWMGFORD **499⁹⁹**

GM
SKU 362555
DRWMGGM **499⁹⁹**

Toyota
SKU 362550
DRWMGMFC **499⁹⁹**



- Designed to Be a Complete J2534 Tool for a Specific Car Manufacturer
- OEM Approved
- Supports Full Factory Diagnostics and Reprogramming
- Free Telephone and Email Support
- Optional Bluetooth® Version



Contact Us:
1-877-AZTool1 Phone
 (1-877-298-6651) *Hablamos Español*

X-431 PRO \$1895.99

SKU 427081
 301190189

FULL SYSTEM DIAGNOSIS IS THROUGH A NEW MORE POWERFUL CLASS-1 BLUETOOTH 4.0 CONNECTOR OFFERING A WIRED EXPERIENCE WITH A WIRELESS DEVICE

- Featuring the latest Lenovo Tablet and MKT 4 core processor running an open Android™ operating system (5.1.1)
- OE-level access to Asian, European and Domestic applications for module coding, resets, relearns & bi-directional capabilities. 12 graphs of live data per page
- Code Search: Auto searches Google with DTC and related info
- Install third party apps and software. Ultra fast Wi-Fi updates!
- Auto-ID all available vehicle systems and modules
- Class-1 Bluetooth 4.0 connector for a wired experience in a wireless device
- High resolution camera with still and video capabilities (5MP R 2MP F)
- 10" High resolution (1280 x 800) IPS capacitive 10 point touch screen
- Remote diagnostics with optional GOLO telematics connector
- 4290 mAh lithium-ion battery
- One year software subscription included
- OBD I & cables and connectors in a large hard plastic case

NEW & SUPER FAST



X-431 PRO 3 \$2499.99

SKU 427078
 301190171

FULL SYSTEM DIAGNOSIS IS THROUGH A NEW MORE POWERFUL CLASS-1 BLUETOOTH 4.0 CONNECTOR OFFERING A WIRED EXPERIENCE WITH A WIRELESS DEVICE

- Performs Oil service light resets, Electronic Parking Brake (EPB) release, and Steering Angle Sensor (SAS) resets and Battery Reset
- Enhanced Manufacturer Specific DTCs for Domestic, Asian and European Coverage
- Reads and Records enhanced Data Streams for ABS, SRS, Transmission and Engine
- Auto Vehicle ID, Auto Module Search & Fast Protocol ID
- Reads and clears codes on Engine, Transmission (A/T), ABS, and Airbag (SRS) systems – on all makes and all models (16 Pin)
- Support for all 10 test modes of OBD II with Enhanced OBD II Mode 6
- Retrieves generic and manufacturer specific codes current, permanent and pending
- View freeze frame data and I/M Readiness monitor status
- Graph, record, and replay data in full color
- Menu with DTC definitions in English, Spanish & French
- Free Internet updates (USB 2.0)
- 4.0" TFT color display

NEW & SUPER FAST



CRP 123P \$319.99

SKU 119870
 301050231

**VIEW AND GRAPH LIVE DATA FOR ENGINE
 VIEW LIVE DATA FOR ABS, SRS, AND TRANS. SYSTEMS**

- Retrieves Manufacturer Specific Enhanced Data for Domestic, Asian and European vehicles
- Reads and Records Data Streams for ABS, SRS, Transmission and Engine
- Auto ID Vehicles, Auto Module Search & Fast Protocol ID
- Reads and clears codes on Engine, Transmission (A/T), ABS, and Airbag (SRS) systems – on all makes and all models (16 Pin)
- Support for all 10 test modes of OBD II with Enhanced OBD II Mode 6
- Retrieves generic and manufacturer specific codes – Current, Permanent & Pending
- View freeze frame data and I/M Readiness monitor status
- Graph, record, and replay data in full color
- Menu with DTC definitions in English, Spanish & French
- Free Internet updates (USB 2.0)
- 4.0" TFT color display



CRP 129P \$524.99

SKU 119868
 301050232

ELECTRONIC PARKING BRAKE (EPB) RELEASE, STEERING ANGLE SENSOR (SAS) RESETS AND OIL SERVICE LIGHT RESETS

- Performs Oil service light resets, Electronic Parking Brake (EPB) release, and Steering Angle Sensor (SAS) resets and Battery Reset
- Enhanced Manufacturer Specific DTCs for Domestic, Asian and European Coverage
- Reads and Records enhanced Data Streams for ABS, SRS, Transmission and Engine
- Auto Vehicle ID, Auto Module Search & Fast Protocol ID
- Reads and clears codes on Engine, Transmission (A/T), ABS, and Airbag (SRS) systems – on all makes and all models (16 Pin)
- Support for all 10 test modes of OBD II with Enhanced OBD II Mode 6
- Retrieves generic and manufacturer specific codes current, permanent and pending
- View freeze frame data and I/M Readiness monitor status
- Graph, record, and replay data in full color
- Menu with DTC definitions in English, Spanish & French



Millennium 70 \$149.99

SKU 592033
 301050343

THE MILLENNIUM 70 IS THE NEXT GENERATION CODE READER WITH LIVE DATA FOR ENGINE, ABS & SRS

- 4.0" TFT Color Screen
- Full Coverage – Domestic, Asian, European (Gas, Diesel and Hybrid Vehicles 1996 and newer OBD II)
- Reads and Clears OBD II Engine Codes
- Reads and Records Data Stream for Engine
- Reads and Clears ABS & SRS Enhanced Manufacturer Specific Codes and Data
- Live Data Stream for ABS, SRS and OBD II Engine
- Multilingual Support in English, Spanish & French
- 4 Color Graphs – OBD II Engine

NEW



Millennium 40 \$59.99

SKU 592023
 301050340

THE MILLENNIUM 40 IS THE NEXT GENERATION CODE READER WITH LIVE DATA

- 2.4" TFT color display
- Full Coverage – Domestic, Asian, European (Gas, Diesel and Hybrid Vehicles 1996 and newer OBD II)
- Reads and Clears OBD II Engine Codes
- Reads Live Data Stream for Engine
- Graphs Live Data in Color
- Auto ID Vehicles for Fast Protocol ID
- Free Internet updates
- Retrieves Generic and Manufacturer Specific Codes – Current, Pending & Permanent
- View Freeze Frame data and I/M Readiness Monitor Status
- Multilingual Support in English, Spanish & French

NEW



Millennium 90 \$259.99

SKU 592024
 301050345

THE MILLENNIUM 90 IS THE NEXT GENERATION CODE READER WITH LIVE DATA FOR ENGINE, ABS, SRS AND SPECIAL FUNCTIONS

- 4.0" TFT Color Screen
- Full Coverage – Domestic, Asian, European (Gas, Diesel and Hybrid Vehicles 1996 and newer OBD II)
- Reads and Clears OBD II Engine Codes
- Multilingual Support in English, Spanish & French
- Live Data Stream for ABS, SRS and OBD II Engine
- Reads and Clears ABS & SRS Enhanced Manufacturer Specific Codes and Data
- Reads and Records Data Stream for Engine
- Resets Oil Lights, EPB, BMS, DPF, SAS, and ABS Brake Bleed
- 4 Color Graphs – OBD II Engine

NEW



CRP 229 \$799.99

SKU 738108
 301050160

ANDROID SCAN TOOL TABLET WITH 5 INCH HIGH RESOLUTION LCD TOUCH SCREEN

- Android Based and Wi-Fi Enabled for Web Browsing
- Graph Multiple PID's of Live Data
- Access All Vehicle Systems for Reading and Clearing Codes and Live Data
- Performs the Following Functions: Oil Light Resets, Electronic Parking Brake (Retract, Reset), Steering Angle Reset, Battery Registration
- OBDII 16 Pin Connector, MBZ 38 Pin and BMW 20 Pin Connector Included
- English, Spanish and French
- Padded Storage Case Included



CR-HD PLUS \$399.99

SKU 554470
 301050174

LCD DISPLAY, PROVIDES J1587, J1939, J1708 AND OBDII DATA!

NOW with HD & LD Gas and Diesel Coverage

- Covers Class 4 (14,001 Lbs.) Through Class 8 (33,000 Lbs. and Over) Heavy Duty Trucks
- Covers Light & Medium Duty Gas and Diesel Vehicles
- Includes 6-Pin, 9 Pin Deutsch and 16-Pin OBDII Connectors
- Coverage for Engine Transmission, Brakes and More
- Read and Clear Active and Inactive Fault Codes
- Monitor All Data and View Live Data Streams
- Padded Storage Case
- Free Internet Updates



CREADER V+ \$69.99

SKU 554465
 3011050144

CODE READER WITH COLOR SCREEN & LIVE DATA GRAPHING

- Color Screen
- View and Graph TWO PID's of Live Data
- Features O2 Sensor and Evap System Tests
- Coverage for Modes 1 Thru 10
- Permanent Codes
- Pending Codes
- Freeze Frame Data
- Free Internet Updates
- English, Spanish and French



CREADER VII \$179.99

SKU 737756
 301050156

CODE READER WITH RESET CAPABILITIES

- Reset Oil and Service Reminder Lights on Vehicles 1996 and Newer
- View and Graph FOUR PID's of Live Data
- Coverage for the Latest Modes 1 Thru 10
- Freeze Frame Data
- Read and Clear DTCs
- Special Tests: I/M Readiness, MIL Status, O2 Sensor, Evap System, Vehicle Info, Code Look-Up and On-Board Monitor Test
- English, Spanish and French





HEAVY DUTY PUNCH

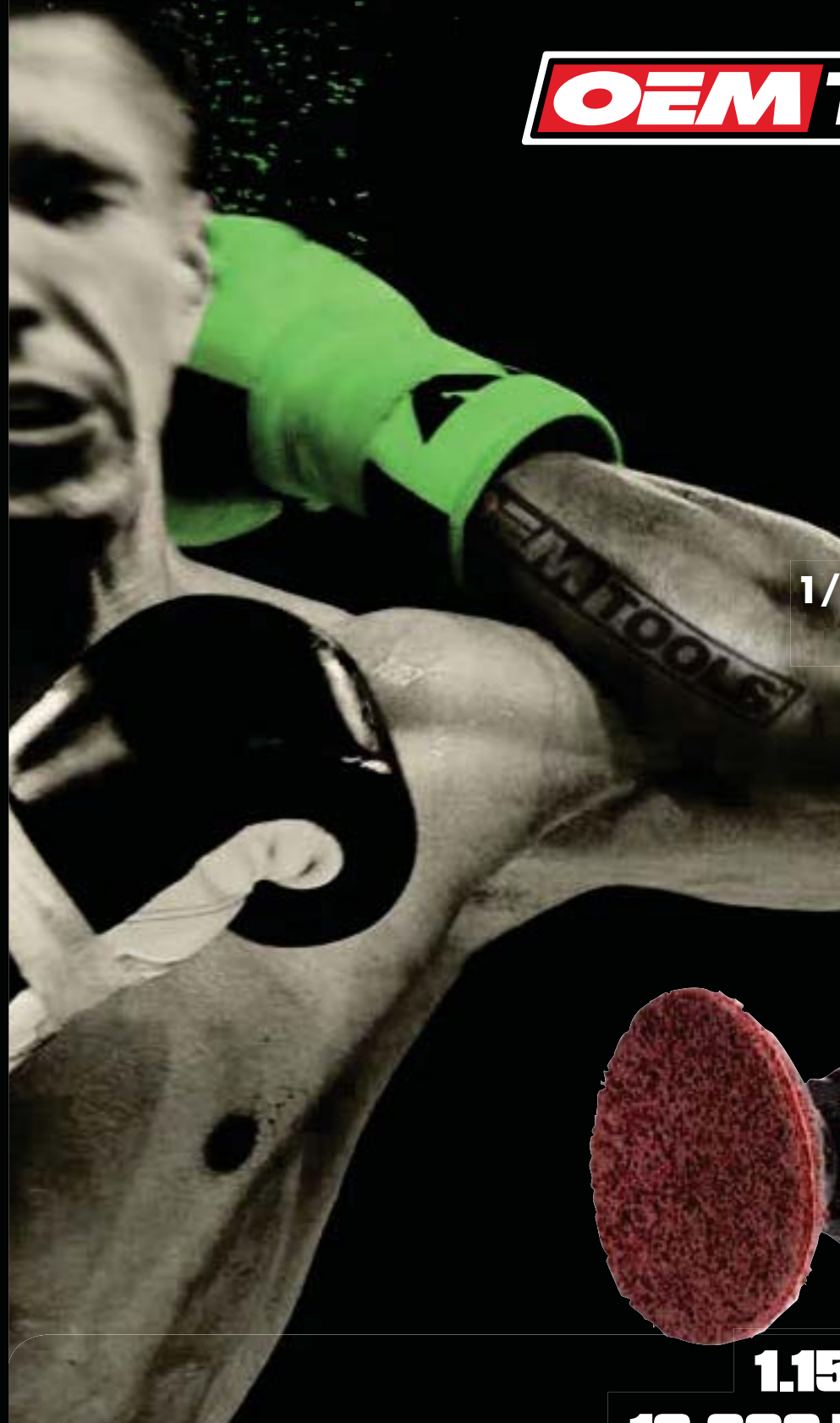

2.98 Lbs.
10,000 RPM

**1/2" Composite Stubby
 Air Impact Wrench**

SKU 087596 **169⁹⁹** REG. \$199.99
 24418

- Air Consumption: 4.0 CFM @ 90 PSI
- Air Inlet: 1/4" NPT
- Max Torque: 900 Ft./Lbs.
- Includes (7) 1/2" Impact Sockets in a Soft Foam Storage Tray

**SAVE
 \$30**



1.15 Lbs.
12,000 RPM

**Composite Mini
 Surface Prep Kit**

SKU 087620 **124⁹⁹** REG. \$149.99
 24417

- Air Consumption: 2.1 CFM @ 90 PSI
- Air Inlet: 1/4" NPT
- Includes: 2" and 3" Surface Prep and Sander Discs

**SAVE
 \$25**



OEMTOOLS® really packs a **PUNCH!** If you want tools with impact, check out our full line of Air Tools – including the Heavy Duty 1/2" Drive Air Impact Wrench and the Heavy Duty Mini Air Surface Prep Kit. Unleash the **PUNCH** you need to finish the job with OEMTOOLS®.

Products come with a Limited Lifetime Warranty

Offers Good Through June 30, 2017 - While Supplies Last

QUALITY - INNOVATION - VALUE

AIR COMPRESSORS



QUALITY - INNOVATION - VALUE

INDUSTRIAL GRADE COMPRESSORS

All Compressors Include:

- **Bonus Start-Up Kit**
- **Full Two Year Warranty**
- **Nationwide Service Network**
- **ASME Tank and Safety Valves**
- **High-Flow Belt Guard**



10 HP 120 Gallon 230V Air Compressor

SKU 592204
26104 **2,699⁹⁹**

- **Magnetic Starter Mounted and Wired**
- 3-Phase
- 35 CFM @ 100 PSI
- 175 PSI Max Pressure
- 2-Stage



5 HP 80 Gallon 230V Compressor

- **Magnetic Starter Mounted and Wired**
- **Heavy-Duty Low RPM Cast Iron Pump**
- 18 CFM at 100 PSI
- 175 PSI Max Pressure
- 2-Stage

Single-Phase

SKU 592257
26100 **1,699⁹⁹**

3-Phase

SKU 592202
26101

7.5 HP 80 Gallon 230V Compressor

- 23 CFM @ 100 PSI

Single-Phase

SKU 592252
26102 **2,099⁹⁹**

3-Phase

SKU 592239
26103



GAS POWERED

13 HP 30 Gallon Honda Gas Powered

SKU 592266
26105 **2,399⁹⁹**

- **Heavy-Duty Low RPM Cast Iron Pump**
- 23 CFM @ 100 PSI
- 175 PSI Max Pressure
- Electric and Recoil Start

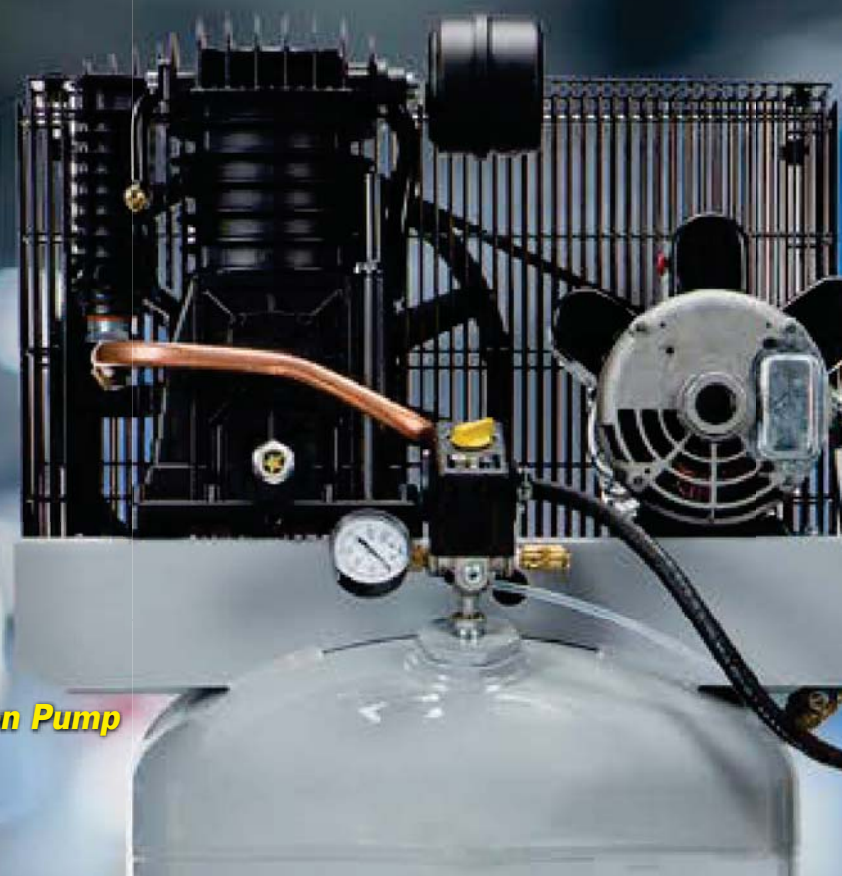

**Unbeatable
Value**



5 HP 60 Gallon 230V Air Compressor

SKU 592262
26106 **1,099⁹⁹**

- 5 HP
- 1 Phase
- 15.3 CFM @ 100 PSI
- 165 PSI Max Pressure
- 2-Stage

AIR COMPRESSORS

30 Gallon 2 Stage Compressors

13 HP Horizontal with Honda Engine

SKU 110435
IRT2475F13GH **2,749⁹⁹**

- Gas Powered Honda Engine
- CFM: 25 @ 175 PSI
- Cast Iron Pump

DELIVERY INCLUDED

Ready To Ship
IN STOCK



Lift Gate Service
SKU 262532
IRTLIFTGATE **80⁰⁰**

Start-Up Kit

SKU 970499
IRT32312936 **134⁹⁹**

- Includes: (2) Air Filter Elements, (2) Quarts 4 Cycle Engine Oil, (4) Liters of All Season Synthetic Lube
- Use of Kit Extends Compressor Pump Warranty to 2 Years

13 HP Horizontal with Honda Engine

SKU 110306
OEMTUK13030HGE **2,099⁹⁹**

- Gas Powered Honda Engine
- CFM: 22 @ 175 PSI
- Cast Iron Pump

PLUS:

- Synthetic Oil

BEST VALUE



OEM Tank Color May Vary Depending on Stock

Lift Gate Service
SKU 295540
OEMLIFTGATE **80⁰⁰**

DELIVERY INCLUDED

Ready To Ship
IN STOCK

13 HP Horizontal with Honda Engine

SKU 344741
CPTRCP1330G **2,549⁹⁹**

- 175 Max PSI
- CFM: 25.3 @ 100 PSI
- Premium Cast Iron and Aluminum Hybrid Pump
- 12V Electric and Recoil Starter Standard
- EZ Pull Type Tank Drain
- Oil Monitor
- Cold Start Valve
- Full 2 Year Warranty

Chicago Pneumatic
HONDA



Lift Gate Service
SKU 361260
CPTLIFTGATE **75⁰⁰**

DELIVERY INCLUDED

60 Gallon 2 Stage Compressors

5 HP Vertical Air Compressor

SKU 210433
IRT2340L5 **1,499⁹⁹**

- CFM: 14.7 @ 175 PSI
- Volts: 230 Single Phase
- Cast Iron Pump
- Factory Mounted and Wired Motor Starter

DELIVERY INCLUDED

Ready To Ship
IN STOCK



Lift Gate Service
SKU 262532
IRTLIFTGATE **80⁰⁰**

Start-Up Kit

SKU 970496
IRT32305880 **134⁹⁹**

- (4) Quarts Synthetic Lube and (2) Air Filters
- Use of Kit Extends Compressor Pump Warranty to 2 Years

5 HP Vertical Air Compressor with Magnetic Starter

SKU 110299
OEMTE5060VM **1,099⁹⁹**

- CFM: 15 @ 150 PSI
- Volts: 230 Single Phase
- Cast Iron Pump
- Factory Mounted and Wired Motor Starter
- Easy Access Drains

PLUS:

- Vibration Damper Pads
- Synthetic Oil

BEST VALUE



OEM Tank Color May Vary Depending on Stock

Lift Gate Service
SKU 295540
OEMLIFTGATE **80⁰⁰**

DELIVERY INCLUDED

Ready To Ship
IN STOCK

5 HP Reciprocating Air Compressor

SKU 344627
CPTRCP561VNS **1,099⁹⁹**

- CFM 15.3 @ 100 PSI
- Volts: 208 - 230 Single Phase
- 165 Max PSI
- Premium Cast Iron and Aluminum Hybrid Pump
- Magnetic Starter: Not Required
- Full 2 Year Warranty

Chicago Pneumatic



Lift Gate Service
SKU 361260
CPTLIFTGATE **75⁰⁰**

DELIVERY INCLUDED

80 Gallon 2 Stage Compressors

5 HP Vertical Air Compressor

SKU 095102
IRT2475N5V **2,349⁹⁹**

- CFM: 16.8 @ 175 PSI
- Volts: 230 Single Phase
- Cast Iron Pump
- Factory Mounted and Wired Motor Starter

DELIVERY INCLUDED

Ready To Ship
IN STOCK



5 HP Premium Vertical Air Compressor

SKU 040598
IRT2475N5-P **2,569⁹⁹**

- Features of the Non-Premium Model Plus Air-Cooled Aftercooler
- Electronic Automatic Tank Drain
- Low Oil Level Protection Switch

Ready To Ship
IN STOCK

7.5 HP Vertical Air Compressor

SKU 210434
IRT2475N7.5 **2,499⁹⁹**

- CFM: 24 @ 175 PSI
- Volts: 230 Single Phase
- Cast Iron Pump
- Factory Mounted and Wired Motor Starter

Ready To Ship
IN STOCK



7.5 HP Premium Vertical Air Compressor

SKU 040597
IRT2475N7.5P **2,649⁹⁹**

- Features of the Non-Premium Model Plus Air-Cooled Aftercooler
- Electronic Automatic Tank Drain
- Low Oil Level Protection Switch

Start-Up Kit

SKU 970496
IRT32305880 **134⁹⁹**

- (4) Quarts Synthetic Lube and (2) Air Filters
- Use of Kit Extends Compressor Pump Warranty to 2 Years

Lift Gate Service
SKU 262532
IRTLIFTGATE **80⁰⁰**

5 HP Vertical Air Compressor

SKU 110300
OEMTN5080VM **1,599⁹⁹**

- CFM: 16.5 @ 175 PSI
- Volts: 230 Single Phase
- Cast Iron Pump
- Factory Mounted and Wired Motor Starter
- Easy Access Drains

PLUS:

- Vibration Damper Pads
- Low Oil Shut-Off
- Synthetic Oil

BEST VALUE



OEM Tank Color May Vary Depending on Stock

Lift Gate Service
SKU 295540
OEMLIFTGATE **80⁰⁰**

DELIVERY INCLUDED

Ready To Ship
IN STOCK

5 HP Vertical Air Compressor

SKU 012631
CPTRCP-381VS **1,749⁹⁹**

- CFM: 18.5 @ 100 PSI
- Volts: 208 - 230 Single Phase
- 175 Max PSI
- Premium Cast Iron and Aluminum Hybrid Pump
- Mag Starter Included
- Solid Cast Iron Cylinders
- High Performance Inter-Cooler and Aftercooler
- Comes Ready to Run, No Start-Up Kit Required

Chicago Pneumatic



Lift Gate Service
SKU 361260
CPTLIFTGATE **75⁰⁰**

5 HP Premium Vertical Air Compressor

SKU 344629
CPTRCP581V **2,249⁹⁹**

- Premium Model Includes: Low Oil Level Switch, Auto Tank Drain, Triple Pass Pump Mounted Aftercooler

7.5 HP Vertical Air Compressor

SKU 012624
CPTRCP-7581VS **2,099⁹⁹**

- CFM: 25.3 @ 100 PSI
- Volts: 208 - 230 Single Phase
- 175 Max PSI
- Premium Cast Iron and Aluminum Hybrid Pump
- Mag Starter Included
- Solid Cast Iron Cylinders
- High Performance Inter-Cooler and Aftercooler
- Comes Ready to Run, No Start-Up Kit Required



7.5 HP Two Stage Premium Model

SKU 344631
CPTRCP-7581V **2,349⁹⁹**

- Premium Model Includes: Low Oil Level Switch, Auto Tank Drain, Triple Pass Pump Mounted Aftercooler

120 Gallon 2 Stage Compressors

10 HP Horizontal Air Compressor

SKU 210437
IRT2545E10V **2,899⁹⁹**

- CFM: 35 @ 175 PSI
- Volts: 230 Three Phase
- Cast Iron Pump
- Factory Mounted and Wired Motor Starter

DELIVERY INCLUDED

Lift Gate Service
SKU 262532
IRTLIFTGATE **80⁰⁰**

10 HP Premium Horizontal Air Compressor

SKU 040549
IRT2545E10-P **3,949⁹⁹**

- Features of the Non-Premium Model Plus Air-Cooled Aftercooler
- Electronic Automatic Tank Drain
- Low Oil Level Protection Switch

Ready To Ship
IN STOCK



Start-Up Kit

SKU 970497
IRT32305898 **164⁹⁹**

- (4) Quarts Synthetic Lube and (2) Air Filters
- Use of Kit Extends Compressor Pump Warranty to 2 Years

10 HP Horizontal Air Compressor Three Phase

SKU 110305
OEMTUK100120M3 **2,599⁹⁹**

- CFM: 32.5 @ 175 PSI
- Volts: 230 Three Phase
- Cast Iron Pump
- Factory Mounted and Wired Motor Starter

OEM TOOLS

PLUS:

- Low Oil Shut-Off
- Synthetic Oil
- Auto Drain

10 HP Horizontal Air Compressor Single Phase

SKU 110303
OEMTUK100120M1 **2,999⁹⁹**

Lift Gate Service
SKU 295540
OEMLIFTGATE **80⁰⁰**

Ready To Ship
IN STOCK

DELIVERY INCLUDED



OEM Tank Color May Vary Depending on Stock

10 HP Horizontal Air Compressor

SKU 012626
CPTC10123HS **2,749⁹⁹**

- CFM: 35 @ 100 PSI
- Volts: 208 - 230 Three Phase
- 175 Max PSI
- Premium 800 RPM Cast Iron Pump
- Mag Starter Included
- Concentric Disc Valves
- Cast Iron Inter-Cooler and Aftercooler
- Full 2 Year Warranty

Chicago Pneumatic



10 HP Vertical Air Compressor

SKU 012634
CPTC10123VS **3,049⁹⁹**

Lift Gate Service
SKU 361260
CPTLIFTGATE **75⁰⁰**



Free Delivery!
in 48 Continental United States

Specifications Subject to Change without Notice or Liability. Customers Responsible for Off-Loading Equipment Upon Arrival.

Leasing Terms Available!
Ask Your AutoZone® Commercial Sales Manager.



Contact Us:
1-877-AZTool1 Phone
 (1-877-298-6651) *Hablamos Español*

How to Size Your Air Compressor

Determine Compressor Type:

- Single Tech Shop or Low Volume Usage: Single-Stage (90-125 PSI)
- Two or More Tech Shops or High Volume Usage: 2 Stage (125-175 PSI)

Determine Air Consumption. Conduct a Shop Audit on Air Requirements or Use These Benchmarks:

- 5 CFM per Person in General Repair Shop
- 8 CFM per Person in Heavy Duty Truck Shop
- 12 CFM per Person in Paint and Body Shop

Make Adjustments to Above Total CFM Requirements to Compensate for Compressor Duty Cycle:

- Multiply by 1.5 for Single Stage
- Multiply by 1.25 for 2 Stage
- Add 10% to Total for Air Leaks and Future Growth in Business

Choose a Compressor That Best Fits the Required CFM per PSI Rating

COMMON AIR TOOL CFM CONSUMPTION

AIR TOOL	CFM
Air Hammer	4.0
Body Polisher	2.0
Body Orbital Sander	5.0
Die Grinder	5.0
Drill, 1/16" to 3/8"	4.0
Grease Gun	3.0
Hydraulic Floor Jack	6.0

AIR TOOL	CFM
Impact Wrench, 3/8"	2.0
Impact Wrench, 1/2"	3.5
Impact Wrench, 3/4"	7.5
Impact Wrench, 1"	10
Medium Duty Sander	40.0
Spring Oiler	4.0
Touch-Up Paint Spray Gun	3.5

Gas Compressors

5.5 HP, 30 Gallon Horizontal with Honda Engine

SKU 110298
 OEMPUK5530G **999⁹⁹**

- Gas Powered Honda Engine
- CFM: 12 @ 90 PSI
- ASME Certified

CARB Compliant



OEM TOOLS
HONDA

Ready To Ship
IN STOCK

Lift Gate Service
 SKU 295540
 OEMLIFTGATE **80⁰⁰**

8 HP, 30 Gallon Horizontal with Honda Engine

SKU 979920
 OEMTUE8030HGE **1,799⁹⁹**

- Electric Start
- CFM: 16 @ 175 PSI
- Cast Iron Pump
- Synthetic Oil

CARB Compliant



Single Stage Compressors

Single Stage, 6 HP* 60 Gallon Vertical Compressor

SKU 110297
 OEMPK7060VS **999⁹⁹**

- 3 Cylinder Cast Iron Pump
- 19.5 CFM @ 90 PSI
- Max. PSI: 150
- 230 Volt/Single Phase
- *3 HP/6 HP Peak

Ready To Ship
IN STOCK

Lift Gate Service
 SKU 295540
 OEMLIFTGATE **80⁰⁰**



PLUS:

- Vibration Damper Pads, Synthetic Oil, Easy Tank Drain

OEM Tank Color May Vary Depending on Stock

Single Stage, 5 HP* 20 Gallon Vertical Compressor

SKU 110315
 PUMPK5020VP **529⁹⁹**

- CFM: 7.1 @ 40 PSI
- CFM: 5.5 @ 90 PSI
- 120/240 Volt / Single Phase
- *2 HP/5 HP Peak



Single Stage 6 HP* 60 Gallon Vertical Compressor

SKU 436011
 PUMPK6060V **599⁹⁹**

- 2 Cylinder Cast Iron Pump
- 12 CFM @ 90 PSI
- Max PSI: 150
- 230 Volt Single Phase
- *3 HP/6 HP Peak



Compressor Oil SAE30 (1 Qt)
 SKU 301791
 PUM074-SAE30 **19⁹⁹**

Compressor Synthetic Oil (1 Qt)
 SKU 301795
 PUM074-SYN30 **29⁹⁹**

Regulators/Filters/Drains

Digital Air Regulator

SKU 978113
 25862 **29⁹⁹**

- Ensures Accurate and Consistent Air Pressure for Spray Guns and Other Air Operating Tools



Regulator with Gauge (1/4")

SKU 543086
 ARRR262G **24⁹⁹**

- Adjustment Range is 5 -125 PSIG
- Rated for 25 SCFM



In-Line Air Tool Filter (1/4")

SKU 543067
 ARR9132 **14⁹⁹**

- Protect Your Air Tools
- Max Pressure: 500 PSI
- Length: 1-9/16"



Disposable In-Line Desiccant Filter Dryer (1/4")

SKU 543077
 ARRDFD-10 **19⁹⁹**

- Maximum Flow Capacity: 15 CFM
- Maximum Pressure: 125 PSI
- See-Through Housing Shows Desiccant Color Change, Indicates That the Dryer Needs to Be Replaced



Particulate Filter (1/2")

SKU 543079
 ARRF354 **34⁹⁹**

- 40 Micron
- 100 CFM
- 150 PSI



Description	SKU	Part #	Price
Particulate Filter (3/8")	543078	ARRF353	34.99

Air Regulator with Gauge (1/2")

SKU 543091
 ARRR354G **44⁹⁹**

- Adjustment Range is 5 -125 PSIG
- Rated for 100 SCFM



Description	SKU	Part #	Price
Regulator with Gauge (3/8")	543088	ARRR353G	49.99

Automatic Lubricator (1/2")

SKU 543085
 ARRL354 **59⁹⁹**

- Lubricator May Be Filled without Shutting Down Air Line
- 3 Position Adjustment Knob



Description	SKU	Part #	Price
Automatic Lubricator (3/8")	543083	ARRL353	59.99

Electronic Drain (1/2")

SKU 543065
 ARR5804 **69⁹⁹**

- Automatically Drains Compressor Tanks, Receiver Tanks or Filters
- 110 Volt
- 6' Power Cord



Coalescing Filter Oil Removing Filter (1/2")

SKU 543081
 ARRF554AW **69⁹⁹**

- .03 Micron Filter Element
- 37 CFM
- Manual Drain



Description	SKU	Part #	Price
Coalescing Oil Removing Filter (3/8")	543080	ARRF553AW	69.99

Integral Filter/Regulator with Gauge (1/2")

SKU 543071
 ARRB754G **69⁹⁹**

- Operating Pressure Range 5 -125 PSI
- 40 Micron Element
- 3 Position Non-Rising Adjustment Knob



Description	SKU	Part #	Price
Integral Filter/Regulator w/ Gauge (1/4")	543069	ARRB752G	69.99
Integral Filter/Regulator w/ Gauge (3/8")	543070	ARRB753G	69.99

Filter Regulator Lubricator with Gauge Modular Combo (1/2")

SKU 543075
 ARRC33354 **199⁹⁹**

- Cleans, Dries and Lubricates Air Supply
- Operating Pressure Range 5 - 125 PSI
- 40 Micron Element
- 142 CFM



Description	SKU	Part #	Price
Filter Regulator Lubricator w/ Gauge Modular Combo (1/4")	543072	ARRC33352	199.99
Filter Regulator Lubricator w/ Gauge Modular Combo (3/8")	543073	ARRC33353	199.99

5 Stage Desiccant Filter/Dryer

SKU 543076
 ARRC7612XL **419⁹⁹**

- Includes Gauge, Shut-Off Valve and One Gallon of Desiccant
- Lowers the Dew Point to -30° F



Description	SKU	Part #	Price
Replacement Desiccant Silica Gel, 1 Quart	543068	ARR34189	14.99

Compressor/Generator/Welder

Compressor/Generator/Welder

SKU 410033
 MTMAGWSR143M **4,674⁹⁹**

- Quality Cast Iron Two Stage Compressor
- Electric Start Option Included
- Battery and Cables Not Included
- Generator Output: 4,500 Watts Continuous
- Welder: 150A @ 100% Duty Cycle (50 - 170A Working Range)
- CFM: 15.7 @ 175 PSI (Equipped with 150 PSI Maximum Rated Regulator)



CARB Compliant

Free Delivery!
 in 48 Continental United States

Specifications Subject to Change without Notice or Liability.
 Prices Do Not Include Vehicles, Installation or Optional Equipment as Shown.

Customers Responsible for Off-Loading Equipment Upon Arrival.
 Ask Your Sales Rep for Details.

Leasing Terms Available.*
 Ask Your AutoZone® Commercial Sales Manager.

AIR TOOLS

3/8" Impact Wrenches

OEM TOOLS

Mighty Compact 3/8" Drive Impact Wrench

SKU 802213
24411 **119⁹⁹** REG. \$149.99

- Lightweight and Compact, Only Weighs 3.5 Lbs.
- Fits in One Hand (5-1/4" in Length)
- Air Consumption: 4.7 CFM
- Free Speed: 11,000 RPM
- Working Torque: 280 Ft./Lbs.
- Maximum Torque: 320 Ft./Lbs. Reverse
- Clutch Type: Twin Hammer

SAVE \$30

Offer Good Through June 30, 2017
While Supplies Last



3/8" Impact Wrench

IR Ingersoll Rand

SKU 970486
IRTIR212 **199⁹⁹**

- Most Powerful 3/8" Pistol Grip Impact
- Torque: 180 Ft./Lbs.
- Single Hammer Design



3/8" Titanium Impact Wrench

IR Ingersoll Rand

SKU 198065
IRT2115TIMAX **349⁹⁹**

- Torque: 300 Ft./Lbs.
- Feather Touch Trigger and Patented Push Button Forward/Reverse



3/8" Impact Wrenches

OEM TOOLS

OEM TOOLS

Mighty Compact 1/2" Impact Wrench

SKU 626146
24403 **119⁹⁹** REG. \$149.99

- Max. Torque: 450 Ft./Lbs. Reverse
- 3 Torque Adjustments
- Small but Powerful
- Lightweight: 3.5 Lbs.

SAVE \$30

Air Consumption
4.7 CFM

Offer Good Through June 30, 2017
While Supplies Last



1/2" Composite Impact Wrench

SKU 900832
25775 **149⁹⁹**

- Max Torque: 500 Ft./Lbs.
- Soft-grip Handle
- Air Consumption: 3.9 CFM
- Weight: 4.2 Lbs.

Air Consumption
3.9 CFM



Heavy Duty 1/2" Composite Stubby Impact Wrench

OEM TOOLS

SKU 087596
24418 **169⁹⁹** REG. \$199.99

- 1/2" Square Composite Air Impact Delivering 900 Lbs. of Torque
- Air Consumption: 4.0 CFM
- Includes (7) 1/2" Short Impact Sockets Sizes 13 mm-19 mm
- Custom Cut EVA Foam for Storage Tray

SAVE \$30

Offer Good Through June 30, 2017
While Supplies Last



1/2" Composite Impact Wrench

OEM TOOLS

SKU 347258
24400 **199⁹⁹** REG. \$299.99

- Max. Torque: 900 Ft./Lbs.
- Air Consumption: 5.1 CFM
- Air Inlet Thread: 3/8"
- Weight: 4.58 Lbs.
- Sound Level: 96.2 dBA

Air Consumption
5.1 CFM

SAVE \$100

Offer Good Through June 30, 2017
While Supplies Last



1/2" Drive Composite Impact Wrench

M7

SKU 592243
KNGNC-4255Q **219⁹⁹**

- 1200 Ft./Lbs. Max Reverse Torque
- 85 dBA Noise Level Bests OSHA Standards
- Ultra Lightweight at 3.74 Pounds
- Twin Hammer Mechanism

NEW



1/2" Impact Wrench

OEM TOOLS

SKU 884521
25821 **59⁹⁹**

- Torque: 400 Ft./Lbs.
- 6,500 RPM Forward



1/2" Impact Wrench

OEM TOOLS

SKU 900831
25774 **89⁹⁹**

- Torque: 400 Ft./Lbs.
- 5.6 CFM Air Consumption



1/2" Impact Wrench

OEM TOOLS

SKU 466599
25769 **89⁹⁹**

- Torque: 425 Ft./Lbs.
- 4 CFM Air Consumption



1/2" Impact Wrench Classic

IR Ingersoll Rand

SKU 495316
IRT231C **144⁹⁹**

- Torque: 600 Ft./Lbs.
- Pressure-Fed Lubrication
- Adjustable Power Regulator
- 1/2" Square Drive

Original Twin Hammer Impact



1/2" Drive Impact Wrench

M7

SKU 592249
KNGNC-4232Q **189⁹⁹**

- Mighty Small, Mighty Powerful Air Impact Wrench
- 700 Ft./Lbs. Max Reverse Torque
- 85 dBA Noise Level Bests OSHA Standards
- Ultra Lightweight at Less Than 3 Pounds
- Twin Hammer Mechanism

NEW



1/2" Impact Wrench

IR Ingersoll Rand

SKU 970487
IRT231HA **199⁹⁹**

- Pressure-Fed Lubrication System
- Handle Exhaust Directs Air Away from User
- Industry Standard for 3 Decades
- Sound Pressure: 94 - 105 dBA

590 Ft./Lbs. of Torque



1/2" Super Air Impact Wrench with 2" Extended Anvil

IR Ingersoll Rand

SKU 604744
IRT231HA2 **229⁹⁹**

- In-Handle Exhaust Directs Air Away from User
- 590 Ft./Lbs. Maximum Torque
- Pressure-Fed Lubrication System

Best Selling Tire Impact



1/2" Quiet Impact Wrench

IR Ingersoll Rand

SKU 738489
IRT2135QXPA **289⁹⁹**

- Torque: 780 Ft./Lbs.
- Light, Quiet and Powerful Impact
- Twin Hammer Mechanism
- Weighs Only 4 Lbs.

Super Quiet



1/2" Titanium Impact Wrench

IR Ingersoll Rand

SKU 695134
IRT2235TIMAX **329⁹⁹**

- 1,350 Ft./Lbs. of Torque
- 930 Ft./Lbs. of Reverse Torque
- Twin Hammer Impact Mechanism
- Lightweight

1,350 Ft./Lbs. of Nut Busting Torque



1/2" Thundergun Street Legal™ Impact Wrench

IR Ingersoll Rand

SKU 495318
IRT232TGLS **319⁹⁹**

- Torque: 625 Ft./Lbs.
- 10,000 RPM for Lightning Fast Removal is Best-in-Class

10,000 RPM



3/4" Impact Wrenches

OEM TOOLS

3/4" Heavy Duty Impact Wrench

SKU 466617
25810 **279⁹⁹**

- Torque: 1,300 Ft./Lbs.
- 6.6 CFM Air Consumption
- 4,400 RPM Free Speed



3/4" Drive Composite Impact Wrench

M7

SKU 592352
KNGNC-6255Q **279⁹⁹**

- One of the Lightest and Most Powerful 3/4" Drive Guns
- 1400 Ft./Lbs. of Max Reverse Torque
- 85 dBA Noise Level Bests OSHA Standards
- Ultra-Light 4.2 Pounds
- Twin Hammer Mechanism

NEW



3/4" Drive Quiet Air Impact Wrench

M7

SKU 592242
KNGNC-6236Q **289⁹⁹**

- Power of a 3/4" Drive in a 1/2" Body
- 1200 Ft./Lbs. Max Reverse Torque
- 83 dBA Noise Level Bests OSHA Standards
- Weighs 5.9 Pounds
- Twin Hammer Mechanism

NEW



1" Impact Wrenches

OEM TOOLS

1" Super Duty Impact Wrench with Extended Anvil

SKU 466618
25811 **379⁹⁹**

- Torque: 1,600 Ft./Lbs.
- 3,700 RPM Free Speed

Integrated Protective Cover



M7 Mighty Seven NC-8237 1" Drive Air Impact Wrench

M7

SKU 592207
KNGNC-8237 **599⁹⁹**

- Super Light and Quiet for a 1" Gun
- 1800 Ft./Lbs. of Max Reverse Torque
- 92 dBA Noise Level
- 12.8 Pound Weight
- Twin Hammer Mechanism

NEW



1" Impact Wrench with Extended Anvil

IR Ingersoll Rand

SKU 970474
IRTIR285B6 **669⁹⁹**

- 1,770 Ft./Lbs. of Reverse Torque
- 6" Anvil for Better Truck Wheel Nut Accessibility
- Hi-Efficiency Motor





Contact Us:
1-877-AZTool1 Phone
 (1-877-298-6651) *Hablamos Español*

Air Hammers

OEM TOOLS

Heavy Duty Air Hammer

SKU 900833 25776 **79⁹⁹**

- 3,500 BPM
- Recommended Air Pressure: 90 PSI
- Air Consumption: 6.3 CFM
- Air Inlet Thread Size: 1/4" NPT

Accessories Included



Reversible Drills

OEM TOOLS

3/8" Reversible Air Drill

SKU 466595 25765 **89⁹⁹**

- 90 PSI
- 4 CFM Air Consumption
- 2,200 RPM Free Speed
- 35 In./Lbs. Max Torque
- Sound Level: 96 dBA
- Weight: 2-1/2 Lbs.



Cut-Off Tools

OEM TOOLS

Heavy Duty Reciprocating Air Saw

SKU 802225 24409 **89⁹⁹**

- Recommended Air Pressure: 90 PSI
- Air Consumption: 1.7 CFM
- Enhanced Blade Guard Design and Trigger Safety Lock
- 9,000 Strokes per Minute



Air Reciprocating Saw

IR Ingersoll Rand

SKU 970481 IRTIR429 **119⁹⁹**

- Designed for Cutting Intricate Shapes
- Cuts Flat and Curved Surfaces
- Comes with (6) High Speed Steel Cutting Blades



1/4" Air Ratchets

OEM TOOLS

1/4" Industrial Air Ratchet

SKU 466593 25763 **49⁹⁹**

- Delivers 18 Ft./Lbs. of Torque and 240 RPM Free Speed



1/4" Stubby

SKU 970472 IRT105D2 **129⁹⁹**

- Delivers 25 Ft./Lbs. of Torque and 250 RPM Free Speed



1/4" Drive Super Duty Air Impact Ratchet

SKU 850508 24415 **159⁹⁹** REG. \$179.99

- Max Torque: 50 Ft./Lbs.
- Free Speed: 700 RPM
- CFM: 3.1 @ 90 PSI
- Length: 6.5"
- Sealed Head Ratchet Housing Prolongs Tool Life
- Compact and Lightweight
- Most Power to Weight Ratio
- Rear Air Exhaust: 360° Adjustable



SAVE \$20

700 RPM

Impact Mechanism Adds Power and Prevents Kickback
 Offer Good Through June 30, 2017 While Supplies Last

Die Grinders

OEM TOOLS

1/4" Mini Die Grinder

SKU 466591 25761 **44⁹⁹**

- Air Consumption: 4.0 CFM
- Free Speed: 26,000 RPM
- Recommended Air Pressure: 90 PSI
- Air Inlet Thread Size: 1/4" NPT
- Recommended Hose Size: 3/8"



1/4" Mini Air Die Grinder

SKU 802211 24405 **47⁹⁹**

- Air Consumption: 3.4 CFM
- Free Speed: 25,000 RPM
- Recommended Air Pressure: 90 PSI
- Air Inlet Thread Size: 1/4" NPT



Composite Body

1/4" Mini Die Grinder

SKU 802212 24406 **49⁹⁹**

- Air Consumption: 3.4 CFM
- Free Speed: 22,000 RPM
- Recommended Air Pressure: 90 PSI
- Air Inlet Thread Size: 1/4" NPT



Composite Body

1/4" Mini Air Die Grinder

SKU 751631 24404 **49⁹⁹**

- Requires Only 2.4 CFM @ 90 PSI for Optimum Performance
- Free Speed: 25,000 RPM
- Ultra Compact Size Fits Into Spaces Regular Die Grinders Cannot
- Lightweight: 0.7 Lbs.
- Collet Size: 1/4"



Composite Body

1/4" Mini Angle Air Die Grinder

SKU 802214 24407 **59⁹⁹** REG. \$64.99

- Air Consumption: 2.8 CFM
- Free Speed: 18,000 RPM
- Recommended Air Pressure: 90 PSI
- Air Inlet Thread Size: 1/4" NPT
- Angle: 90 Degrees



Composite Body

SAVE \$5

Offers Good Through June 30, 2017 - While Supplies Last

1/4" Extended Air Die Grinder

SKU 802216 24408 **59⁹⁹** REG. \$64.99

- Air Consumption: 2.5 CFM
- Free Speed: 23,000 RPM
- Recommended Air Pressure: 90 PSI
- Air Inlet Thread Size: 1/4" NPT



Composite Body

SAVE \$5

3/8" Air Ratchets

OEM TOOLS

3/8" Pro Air Ratchet

SKU 210212 25819 **49⁹⁹**

- Max Torque: 60 Ft./Lbs.
- Free Speed: 160 RPM
- Recommended Air Pressure: 90 PSI



3/8" Air Ratchet

SKU 970485 IRTIR107XPA **129⁹⁹**

- Max Torque: 54 Ft./Lbs.
- Advanced Head Design
- 360° Adjustable Exhaust



3/8" Drive Reactionless Air Ratchet

SKU 347259 24401 **179⁹⁹**

- Maximum Torque: 75 Ft./Lbs.
- Free Speed: 450 RPM
- Air Inlet: 1/4" NPT
- Air Consumption: 2.5 CFM
- Ratchet Pawl: Single
- Exhaust: Rear

Impact Mechanism Adds Power and Prevents Kickback



3/8" Drive Mini Super-Duty Air Impact Ratchet

SKU 850055 24416 **159⁹⁹** REG. \$179.99

- Max Torque: 50 Ft./Lbs.
- Free Speed: 700 RPM
- CFM: 3.1 @ 90 PSI



SAVE \$20

700 RPM

Offer Good Through June 30, 2017 - While Supplies Last

3/8" Super-Duty Air Ratchet

SKU 495290 IRT109XPA **199⁹⁹**

- Torque: 76 Ft./Lbs.
- Variable Speed Button Trigger
- 360° Adjustable Exhaust



Air Sanders and Polishers

OEM TOOLS

5" High Speed Air Sander

SKU 688297 80-365 **39⁹⁹**

- Free Speed: 18,000 RPM
- Designed for Light Sanding, Feathering, Edging and Rust Removal



High Speed Air Sander*

SKU 466594 25764 **39⁹⁹**

- Air Consumption: 4.5 CFM
- Free Speed: 15,000 RPM
- Recommended Air Pressure: 90 PSI
- Sound Level: 88 dBA
- Weight: 2-1/2 Lbs.



*While Supplies Last

Dual Action Air Sander

SKU 011577 33625830 **49⁹⁹**

- Air Consumption: 4.0 CFM
- Free Speed: 10,000 RPM
- Pad Size: 6"
- Recommended Air Pressure: 90 PSI
- Recommended Hose Size: 3/8"
- Weight: 3.87 Lbs.

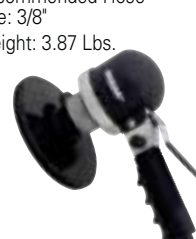

6" Dual Action Sander

SKU 970475 IRTIR311A **79⁹⁹**

- Dual Action Pad Motion Reduces Swirl
- Built-In Silencer for Quiet Operation



2" Surface Prep Tool

SKU 094650 25778 **49⁹⁹**

- RPM: 20,000
- CFM: 3
- 4 Position Air Volume Control
- Quick Change "Twist Lock" Mandrel



All Twist Lock Accessories Work with This Sander

Heavy Duty Mini Surface Prep Kit

SKU 087620 24417 **124⁹⁹** REG. \$149.99

- Includes: (3) 2" and (3) 3" Heavy Duty Mini Air Surface Prep Sander
- (1) 2" Backer Pad & (1) 3" Backer Pad
- (2) 2" and (2) 3" Medium Grit Surface Prep Discs
- (2) 2" and (2) 3" Coarse Surface Prep Discs
- (2) 2" and (2) 3" Sander Discs
- Air Nipple
- Wrench



SAVE \$25

Offer Good Through June 30, 2017 While Supplies Last

Straight Line Sander

SKU 970479 IRTIR315 **149⁹⁹**

- Twin Piston Design for Smooth Operation
- 3,000 Strokes per Minute
- Quick-Action Paper Clamps



Starter Pack Surface Prep Kit

SKU 812338 24944 **29⁹⁹**

- Removes Paint, Rust and Corrosion from Metal, Plastic, Wood and Other Surfaces When Used with OEMTOOLS® 24417 Surface Prep Kit and Other Popular Surface Prep Tools and Die Grinders Fitted with Type R Style Holders
- Includes: (3) 2" and (2) 3" Medium Grit Surface Prep Discs, (5) 2" and (3) 3" Coarse Surface Prep Discs, (3) 2" and (2) 3" Sander Discs



DID YOU KNOW?

AutoZone® has a battery tester Earn Back program.

Contact Your AutoZone Commercial Sales Manager for Details

AIR TOOL ACCESSORIES

TOOL of the MONTH **MAY**
SEE INSERT FOR DETAILS

42 Piece 3/8" Impact Socket Set in EVA Foam Tray **OEM TOOLS**
SKU 087600 23983 **124⁹⁹**



Includes EVA Tray for Convenient Storage

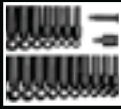

3/8" Drive Deep Drive and Shallow 6-Point SAE and Metric Sockets



Extension Bar and Universal



- (8) 3/8" Drive 6-Point SAE Sockets, Sizes 5/16"-3/4"
- (12) 3/8" Drive 6-Point Metric Sockets, Sizes 8 mm-19 mm
- (8) 3/8" Drive Deep 6-Point SAE Sockets, Sizes 5/16"-3/4"
- (12) 3/8" Drive Deep 6-Point Metric Sockets, Sizes 8 mm-19 mm
- 3/8" Drive 3" Extension Bar
- 3/8" Drive Universal Joint

Impact Sockets



12 Piece, 3/8" Drive Shallow Impact Socket Sets

SKU 391191 25589 (SAE) **26⁹⁹** SKU 391190 25587 (Metric) **21⁹⁹**

- Shallow 6 Point High Quality Impact Sockets
- SAE: 5/16", 3/8", 7/16", 1/2", 9/16", 5/8", 11/16", 3/4", 13/16", 7/8", 15/16" and 1"
- Metric: 8, 9, 10, 11, 12, 13, 14, 15, 16, 17, 18 and 19 mm



12 Piece, 3/8" Drive Deep Impact Socket Sets

SKU 442193 25590 (SAE) **46⁹⁹** SKU 464314 25588 (Metric) **38⁹⁹**

- Deep 6 Point High Quality Impact Sockets
- SAE: 5/16", 3/8", 7/16", 1/2", 9/16", 5/8", 11/16", 3/4", 13/16", 7/8", 15/16" and 1"
- Metric: 8, 9, 10, 11, 12, 13, 14, 15, 16, 17, 18 and 19 mm

33 mm, 1" Drive Budd Wheel Socket

SKU 466569 25528 **24⁹⁹**



35 mm, 1" Drive Budd Wheel Socket

SKU 466566 25525 **25⁹⁹**



1-1/2" Hex x 13/16" Square Deep 1" Drive Budd Wheel Socket

SKU 466570 25529 **29⁹⁹**



- For Budd Wheel 1-1/2" Hex with 13/16" Inside Square

Cut-Off Accessories

Mandrel for 1/4" and 3/8" Screws (2 Pack)

SKU 094907 SHA32 **19⁹⁹**



3" x 1/16" Cut-Off Wheels (25 Pack)

SKU 347215 25839B **24⁹⁹**

- Spindle 3/8"
- 25,000 RPM
- 3" x 1/16" x 3/8"



Cut-Off Wheels (25 Pack)

SKU 094906 SHA25-25 **44⁹⁹**

- 3" x 1/16" x 3/8"



Couplers/Plugs

HI-Flo V-Style 1/4" MNPT Steel Plug, 10 Pack SKU 480772 MILS7601-5 **24⁹⁹**

HI-Flo V-Style 3/8" MNPT Steel Plug, 10 Pack SKU 480775 MILS7621-5 **29⁹⁹**

HI-Flo A,M,V-Style 1/4" FNPT Coupler, 2 Pack SKU 480783 MILS764-2 **24⁹⁹**

HI-Flo A,M,V-Style 3/8" FNPT Coupler, 2 Pack SKU 480784 MILS766-2 **24⁹⁹**

Improves Performance of High Air Consumption Air Tools.

1/2" Female Coupler G-Style, Each SKU 481703 MILS1815 **22⁹⁹**

1/2" Male Coupler G-Style, Each SKU 481696 MILS1816 **22⁹⁹**

1/2" Male Plug G-Style, 5 Pack SKU 480770 MILS1817-5 **29⁹⁹**

1/2" Female Plug G-Style, 5 Pack SKU 480771 MILS1818-5 **34⁹⁹**

1/4" Air Swivel Connectors

SKU 099162 24242 **19⁹⁹**

- 360° Swivel Action at 2 Points for Maximum Maneuverability
- 1/4" NPT
- Maximum Air Pressure: 150 PSI



1/4" Universal, No Scratch, Composite Body Quick Coupler **OEM TOOLS**

SKU 099186 24241 **15⁹⁹**

- Lightweight, Durable Nylon Composite Body
- 1/2" x 18 NPT; Female

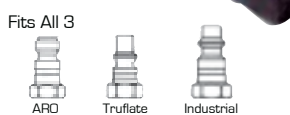

1/4" Universal Composite Body Quick Coupler (5 Pack) **OEM TOOLS**

SKU 297201 24241PK **39⁹⁹**

- Lightweight, Durable Nylon Composite Body
- Quick One-Handed Connection Will Save You Time
- 1/2" x 18 NPT; Female
- One Size Fits Most



Surface Prep

SHOP SUPPLY of the MONTH **APRIL**
SEE INSERT FOR DETAILS

OEM TOOLS

2" Surface Prep Discs (25 Pack) Twist-Lock Style

SKU 125687 24941 **29⁹⁹** 1.20 each

- 2" Coarse Grit / 25 Pack

SKU 125690 24940 **29⁹⁹** 1.20 each

- 2" Medium Grit / 25 Pack

3" Surface Prep Discs (25 Pack) Twist-Lock Style

SKU 125691 24942 **41⁹⁹** 1.68 each

- 3" Coarse Grit / 25 Pack

SKU 125692 24943 **41⁹⁹** 1.68 each

- 3" Medium Grit / 25 Pack



2" Purple Strip Disc with Rollock, 5 Pack

SKU 298097 SHA16206 **19⁹⁹**

- Long-Life Silicon Carbide for Paint and Coating Removal
- Pack of 5 Discs



2" Surface Disc Assortment Twist-Lock Style

SKU 094920 SHA620TBA **39⁹⁹**

- Includes: (12) Coarse, (10) Medium, (3) Fine and (1) 2" Holder



Twist-Lock Disc Holders

SKU 094911 SHA323T2 **24⁹⁹**

- 2" Holder / 2 Pack

Thermostat Gasket Residue Remover

SKU 291346 LIS22500 **25⁹⁹**

- Floating Guide Shaft to Steer Abrasive Pad Around the Gasket Surface
- Use with a Die Grinder to Quickly Clean Off the Gasket Surface



SKU 094916 SHA333T2 **29⁹⁹**

- 3" Holder / 2 Pack

SKU 094912 SHA323TB **24⁹⁹**

- 2" and 3" Holder Set

2" Zirconia Mini Grinding Discs Twist-Lock Style

SKU 094908 SHA3220ZGT **39⁹⁹**

- 2" / 24 Grit / 25 Pack

SKU 094915 SHA3250ZGT **39⁹⁹**

- 2" / 50 Grit / 25 Pack

SKU 094909 SHA3230ZGT **39⁹⁹**

- 2" / 36 Grit / 25 Pack



Impact Adapters

Duralast

5 Piece Impact Grade Adapter Set

SKU 914056 70-383 **22⁹⁹** STORE STOCK

- Made of Chrome Moly Steel for Strength
- Storage Rail
- Includes Sizes: 1/4" to 3/8", 3/8" to 1/2", 1/2" to 3/4", 3/8" to 1/4" and 1/2" to 3/8"



5 Piece Adapter and Universal Joint Set (3/8" and 1/2" Drive)

SKU 965864 24226 **29⁹⁹**

- Made of Chrome Moly Steel for Strength
- Includes: 3/8" Drive Universal Joint, 3/8" Drive (F) x 1/2" (M) Adapter, 1/2" Drive Universal Joint, 1/2" Drive (F) x 3/8" (M) Adapter and 1/2" Drive (F) x 3/4" (M) Adapter



Impact Star

OEM TOOLS

10 Piece External Star Socket Set

SKU 191054 25954 **19⁹⁹**

- Includes: 3/8" - 1/2" Drive Star: E5, E6, E7, E8, E10, E12, E14, E16, E18 and E20
- Features Chrome Moly Steel Components for Strength and Durability
- Comes on a Convenient Storage Clip



Impact Extensions

OEM TOOLS

1/2" to 3/8" Drive Reducing Extension Adapters

SKU 110292 25240 **59⁹⁹**

- 3 Piece Set Includes Sizes: 12", 24" and 36"
- This Specialty Extension Set Lets You Use Your 1/2" Drive Tools with 3/8" Sockets
- Get Into Tight Spots Like Those Around a Transmission Bell Housing



1/2" Impact Grade Extension Set

SKU 914182 70-391 **19⁹⁹**

- Includes Sizes: 6" and 10"
- Chrome Moly Steel for Strength
- Black Oxide Finish to Resist Rust
- Ball Socket Retention

Duralast



AIR HOSES AND REELS

VIPERFLEX®

- Heavy Duty Polymer Hose Material Redefines Flexibility - Stays Flexible Under All Weather Conditions (-40° to 150° F)
- Holds No Memory - Kink Resistant Under Pressure
- 300 PSI Working Pressure.
- Bend Restriction for Reducing Wear and Tear and Extending Life of Hose
- Solid Brass MNPT Ends



SKU 347225 | 24425

SKU 347224 | 24424

Whip Hoses

1/4" NPT End Fittings

ViperFlex® 3/8" x 4' Swivel Whip Hose

SKU 347219 **15⁹⁹**
24420

3/8" NPT End Fittings

ViperFlex® 1/2" x 4' Swivel Whip Hose

SKU 347221 **17⁹⁹**
24421

3/8" Hoses

1/4" NPT End Fittings

ViperFlex® 3/8" x 25' Air Hose

SKU 347222 **19⁹⁹**
24422

ViperFlex® 3/8" x 50' Air Hose

SKU 347223 **25⁹⁹**
24423

ViperFlex® 3/8" x 100' Air Hose

SKU 347225 **49⁹⁹**
24425

1/2" Hoses

1/2" NPT End Fittings

ViperFlex® 1/2" x 25' Air Hose

SKU 347226 **24⁹⁹**
24426

ViperFlex® 1/2" x 50' Air Hose

SKU 347227 **39⁹⁹**
24427

ViperFlex® 1/2" x 100' Air Hose

SKU 347228 **74⁹⁹**
24428

Air Blow Gun

OEM TOOLS

5 Piece Interchangeable Tip Air Blow Gun

SKU 338823 **24⁹⁹**
24439

- Includes 4 Interchangeable Tips: 100 mm (4"), 140 mm (5.5"), 320 mm (12.5") and a Turbo Wide Angle Nozzle
- Quick Change Coupling Makes it Easy to Change Tips
- Wide Angle Nozzle for High Volume
- Variable Trigger to Control Volume and Tip Pressure
- 1/4" NPT Air Inlet



Inflators

OEM TOOLS

Air Chuck with Comfort Grip Handle

SKU 802200 **17⁹⁹**
24414

- Durable, OEM Screwdriver Style Handle for Comfort and a Positive Grip
- Sealed-Ball Air Chuck is Extended 1" from Handle to Allow Access to Tight Areas



Dual Foot Air Chuck with Comfort Grip Handle

SKU 802201 **19⁹⁹**
24413

- Comfortable Screwdriver Style Handle
- 30° Reverse Angle Chuck Can Be Used on Outside Tires
- Tilt Lock Feature Locks Onto the Valve



Dual-Head Chuck Tire Inflator Gauge

SKU 094652 **24⁹⁹**
25864

- 6" Chrome-Plated Dual-Head Chuck with Full 360° Swivel Action and 15" Air Hose
- Capacity: 10 to 120 Lbs.
- Gauge Reads in 2 Lbs. Increments

OEM TOOLS



Digital Tire Inflator

SKU 802198 **49⁹⁹**
24412 REG. \$59.99

- Easy-to-Read Backlit LCD Display
- Four Units of Measure (PSI, Bar, kPa, kgf)
- Measuring Range: 0 - 175 PSI (0 - 12 Bar)
- Accuracy: +/-1.2 PSI Up to 58 PSI, +/-2.3 Between 58 PSI and 145 PSI Inclusive, +/-3.6 PSI Greater Than 145 PSI
- High Air Flow Saves the Technician Time

OEM TOOLS



Tire Inflator

SKU 301772 **59⁹⁹**
24380

- Clear and Easy-to-Read 80 mm 180 PSI Gauge
- 3-in-1 Function: Inflate, Deflate and Measure Tire Pressure
- Increased Accuracy to Improve Tire Performance and Prevent TPMS Comebacks

OEM TOOLS



Inflator Gauge, Dual-Head Straight Foot for Inner Duals

SKU 301603 **59⁹⁹**
MILS516

- 15" Hose
- 10 - 120 PSI Dual Foot Straight Chuck Ideal for Dual Wheel Equipped Vehicles
- Heavy Duty Construction Provides for Long Life Even Under Extreme Use and Conditions
- Gauge and Valve Cartridges are Replaceable
- Equipped with Magnifying Lens for Full View of Scale

MILTON MANUFACTURING, INC.

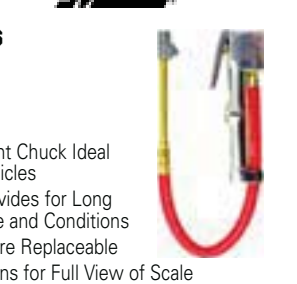

Hoses and Hose Reels

GOOD YEAR
ENHANCED PRODUCTS

3/8" x 25' Red Rubber Air Hose, 1/4" NPT Male Ends

SKU 978117 **29⁹⁹**
24905

- Working Pressure: 250 PSI

3/8" x 50' Red Rubber Air Hose, 1/4" NPT Male Ends

SKU 978112 **34⁹⁹**
24906

- Working Pressure: 250 PSI

1/2" x 50' Red Rubber Air Hose, 1/2" NPT Male Ends

SKU 978116 **59⁹⁹**
24908

- Working Pressure: 250 PSI



ViperFlex® 3/8" x 50' Retractable Hose Reel

SKU 347224 **99⁹⁹**
24424

- Hose Reel Made with Impact Resistant Plastic and Heavy Duty Spring Action
- Retractable Hose Reel Lock Allows You to Lock the Hose in Any Position
- New Spring Action Design Tested Up to 5,000 Times
- 1/4" Solid Brass NPT Inlet

Polymer Hose
Never Kinks!

VIPERFLEX®



3/8" x 50' Air Hose Reel

SKU 900815 **99⁹⁹**
25979

- Smooth Automatic Retracting Spring Coil
- 50 Ft. Hose
- 3/8" NPT Fittings
- Max. Pressure: 250 PSI

OEM TOOLS



3/8" x 50' Value Series Air Hose Reel

SKU 972284 **179⁹⁹**
LIN83753

1/2" x 50' Value Series Air Hose Reel

SKU 972285 **199⁹⁹**
LIN83754

- Retractable Delivery Hose
- Durable Heavy Gauge Steel Construction
- Slotted Mounting Base for Easy Installation

LINCOLN



50' Hose Reel

SKU 343407 **199⁹⁹**
DAN116911

- 50' of 3/8" of Rubber Hose
- Working Pressure: 250 PSI
- Max CFM: 25
- 4 Way Non-Snag Rollers

Dannmar
EQUIPMENT



Piping Systems

RapidAir Compressed Air Piping System 1/2" Master Kit

SKU 360485 **139⁹⁹**
RAP90500

- Designed to Easily Install Beneath Walls of New Construction or on Wall Surfaces of Existing Workshops
- Allows Compressed Air Lines Exactly Where You Want Them, Just Like Electrical Outlets
- Includes: (2) Air Outlet Kits, (1) Compressor Manifold Kit, 100' Nylon Tubing and Tubing Cutter



100 Ft. RapidAir Tubing Kit
SKU 360549 **49⁹⁹**
RAP20100

1/2" RapidAir Outlet Kit
SKU 360542 **32⁹⁹**
RAP90100

Compressor Manifold Kit
SKU 360548 **34⁹⁹**
RAP90200

MaxLine Compressed Air Piping System 3/4" Master Kit

SKU 360593 **249⁹⁹**
RAPM7500

- Heavier Duty Components for Longer Air Runs in Larger Buildings
- (3) Air Outlets, (1) 3/4" NPT Straight Fitting, (2) Tees, (20) Clips
- 100' of 3/4" HDPE Tubing

300 Ft. 3/4" MaxLine Tubing Kit
SKU 360650 **369⁹⁹**
RAPM6031

100 Ft. 3/4" MaxLine Tubing Kit
SKU 360649 **139⁹⁹**
RAPM6030

3/4" MaxLine Outlet Kit
SKU 360629 **29⁹⁹**
RAPM7510

Aluminum Core: Holds
Any Bent Shape!

3/4" Union Fitting
SKU 360656 **19⁹⁹**
RAPM8022



AIR TOOLS AND ACCESSORIES

NEW ITEMS

Digital Tire Inflator

SKU 543041 19357 **89⁹⁹**

STORE STOCK

- Easy to read backlit LCD display
- 90 Second auto-off function
- Four units of measure: p.s.i., bar, kPa, & kgF
- 20° swivel hose
- Inflation range: 0-174 psi
- Inlet thread: 1/4" Female BSP



360 Degree Swivel Connector

SKU 543140 19444 **6⁹⁹**

STORE STOCK

- Swivels 360° in both directions
- Reduces stress at hose connection points
- Works with 1/4" NPT fittings & quick connect adapters



3-Way Quick Connect Female Coupler

SKU 543306 19461 **5⁹⁹**

STORE STOCK

- Quick connect design allows for quick assembly and release of air tools
- AMT 3-Way Style accepts the 3 most popular 1/4" nipple styles:
 - A Style: ARO 210 style
 - M Style: Milton or Industrial Style
 - T Style: Tru-Flate/Parker Automotive Style



5pc High Flow Quick Connect Coupler & Plug Set

SKU 543355 19460 **12⁹⁹**

STORE STOCK

- H/F High Flow couplers and plugs are machined with larger inside diameters, doubling the amount of air flow to your tool
- Great for applications requiring high volumes of air: abrasive blast cabinets, HVLP spray guns, cut-off tools, die grinders, & other high CFM air tools



2-Way Swivel Splitter

SKU 543231 19445 **17⁹⁹**

STORE STOCK

- Fits A, M, and T style fittings
- Splits (1) 1/4" air line into (2) 1/4" outputs
- Allows connection of (2) tools to a single outlet
- 360° Swivel feature reduces kinks in hose



VAPER Air Tools

Siphon Feed Spray Gun

SKU 976511 19418 **54⁹⁹**

STORE STOCK

- Fully Adjustable Spray Pattern
- 1.8 mm Needle and Nozzle Set for Heavier Materials
- Non Bleeder Type, Siphon Feed
- Spun Aluminum 1 Liter Canister



1.4 mm Gravity Feed HVLP Spray Gun

SKU 976510 19014 **54⁹⁹**

STORE STOCK

- Lightweight Plastic Paint Cup
- Stainless Steel Needle and Nozzle Set Resists Corrosions and Wear from Abrasive Materials
- Air Valve for Precise Air Flow Adjustment
- Includes Pressure Regulator and Cleaning Kit



Dual Setup Spray Gun Kit

SKU 976507 19800 **99⁹⁹**

STORE STOCK

- 1.4 mm Set for Lighter Materials
- 1.7 mm Set for Heavier Materials
- Locking Pressure Regulator with Gauge
- Operating Pressure: 15 - 45 PSI



1/2" Drive Air Impact Wrench

SKU 976504 19748 **54⁹⁹**

STORE STOCK

- Ideal for Removing/Installing Nuts and Bolts, Tire Changing, General Assembly and Other Workshop Applications
- Die Cast Aluminum Body with Rubber Scuff Guards
- Built-in Air Regulator Varies Speed and Power
- 230 Ft/Lbs. Maximum Torque



Air Die Grinder

SKU 977046 19747 **24⁹⁹**

STORE STOCK

- Ideal for Light Duty Metal Fabrication, Grinding, Porting and Polishing Applications
- Durable, Lightweight Composite Housing Design Helps Reduce Vibration
- Lever Lock Throttle for Safety
- 1/4" Collet



3" Air Cut-Off Tool

SKU 976505 19746 **39⁹⁹**

STORE STOCK

- Ideal for Cutting Sheet Metals, Fiberglass, Bolts, Muffler Clamps, Etc
- 18,000 RPM No Load Speed
- Includes 3" Abrasive Wheel
- Includes Arbor Wrench and Allen Wrench



3/8" Drive Air Ratchet

SKU 976509 19749 **49⁹⁹**

STORE STOCK

- Durable, Lightweight Composite Housing
- Forward/Reverse Lever Conveniently Located for Quick Direction Changes
- Front Exhaust Blows Debris Away from Work Area
- 45 Ft/Lbs. Max Torque



Air Hammer

SKU 976508 19750 **24⁹⁹**

STORE STOCK

- Ideal for General Cutting, Chipping and Scraping
- Hardened Steel Barrel and Piston
- Die Cast Aluminum Body with Rubber Scuff Guards
- Includes (1) Spring Retainer and (4) Most Popular Chisels



4 Piece Air Chisel Set

SKU 977873 19355 **5⁹⁹**

STORE STOCK

- Assortment of the Most Popular Chisels
- 4-3/4" Overall Length
- Bushing Splitter, Weld Buster, Ripping Chisel and Tapered Punch



3" x 1/16" Cut-Off Wheel

SKU 977872 19336 **3⁹⁹**

STORE STOCK

- Spindle 3/8"
- 25,000 RPM



5 Piece Grinding Wheel Set

SKU 977880 19352 **2⁹⁹**

STORE STOCK

- 25,000 RPM Rated



1/4" x 25' Recoil Hose

SKU 977897 19368 **12⁹⁹**

STORE STOCK

- 1/4" NPT (M)
- Swivel Ends

50' PVC Air Hose

SKU 977899 19371 **22⁹⁹**

STORE STOCK

- Premium Grade Hose with Bend Restrictors at Each End for Prolonged Life
- Working Pressure: 300 PSI
- Burst Pressure: 1,200 PSI
- Resists Gasoline, Oil and Other Automotive Liquids



50' Rubber Air Hose

SKU 359693 19382 **34⁹⁹**

STORE STOCK

- Working Pressure: 300 PSI
- Burst Pressure: 1,200 PSI
- 3/8" Brass Fittings
- Vinyl Kink Restrictors



(2) 3/8" Hose Splicers

SKU 977888 19345 **2⁹⁹**

STORE STOCK



(2) 3/8" Hose Ends

SKU 980359 19346 **2⁹⁹**

STORE STOCK

- 1/4" NPT



Piston Style Blow Gun

SKU 977886 19360 **6⁹⁹**

STORE STOCK

- Air Inlet 1/4" NPT
- Fiberglass Reinforced Nylon Body for Strength
- OSHA Compliant Tip



Blow Gun with Removable Venturi Tip

SKU 807628 19402 **12⁹⁹**

STORE STOCK

- Venturi Tip Allows for 4X the Air Flow
- Lightweight and Durable
- 1/4" NPT
- Working Pressure: 90 - 120 PSI



Blow Gun with Rubber Tip

SKU 976307 19435 **6⁹⁹**

STORE STOCK

- 1/4" (6.3 mm) NPT (F)



17 Piece Accessory Kit

SKU 977877 19338 **17⁹⁹**

STORE STOCK

- 1/4" NPT (F)
- Kit Includes: Safety Lever Blow Gun, Blow Gun Inflators, Pressure Gauge, Dual Tire Chuck, Coupler, (2) Male Connectors, Female Connector, (2) Female Couplers and (4) Male Couplers



Air Adjusting Valve with Gauge

SKU 978090 19359 **7⁹⁹**

STORE STOCK

- 0 to 140 PSI
- 1/4" NPT
- Male and Female Fittings



Air Adjusting Valve with Gauge

SKU 977895 19303 **17⁹⁹**

STORE STOCK

- 1/4" NPT



Spot Sprayer

SKU 333347 19419 **34⁹⁹**

STORE STOCK

- Designed to Spray Fluids Such As Alcohol, Solvents and Cleaners
- 80 - 150 PSI Operating Pressure
- Refillable Metal Construction
- Eliminates Harmful Propellants
- 32 Oz. Capacity



2 Piece Disposable Filters

SKU 977871 19302 **7⁹⁹**

STORE STOCK

- Helps Reduce Painting Defects
- Removes Moisture, Oil Vapor and Rust Particles that Pass Through Conventional Filters



Thread Seal Tape

SKU 807362 19320 **1⁹⁹**

STORE STOCK

- Use On Air Line Connections to Prevent Leaks
- 1/2" x 260"



Dual Foot Inflator and Gauge

SKU 977878 19341 **17⁹⁹**

STORE STOCK

- 1/4" NPT (F)



Quick Connect Set

SKU 977885 19330 **4⁹⁹**

STORE STOCK

- 1/4" NPT Female
- 1/4" NPT Male
- Interchangeable with Milton - "M" Style and Amflo - Type



Swivel Plug

SKU 480787 19327 **4⁹⁹**

STORE STOCK

- 1/4" (6.3mm) NPT (M)
- 30° Swivel Action Reduces Fatigue By Increasing Mobility at the Tool
- Swivel Feature for Easy Access in Confined Spaces





Contact Us:
1-877-AZTool1 Phone
 (1-877-298-6651) *Hablamos Español*

NEW Tools of the Trade



ALLDATA TECH-ASSIST[™]

ALLDATA MOBILE[®]

Industry-leading OEM repair information – right at your fingertips

ALLDATA MOBILE

No more back and forth between the vehicle and the computer station. Get all the OEM repair data you need with a subscription to ALLDATA Repair[®] and Mobile. With our mobile app you can read/clear P-Codes, view live sensors, pre-check emissions, and more with an OBDII connector and tablet.

Ask about our tablet bundles!



App built specifically for tablet devices

Easy to read information grid

Access vehicle DTCs

Sensor data check

TECH-ASSIST



ALLDATA Tech-Assist is staffed by a highly-skilled diagnostic team of ASE Certified Master Technicians. Whatever you need – from creating alternative diagnostic strategies to providing step-by-step repair assistance – we can deliver! It's like having a Master Technician in your shop that isn't on your payroll.

©2017 ALLDATA LLC. All rights reserved. ALLDATA, ALLDATA Repair, ALLDATA Mobile and ALLDATA Tech-Assist are registered trademarks of ALLDATA LLC. AutoZone and AutoZone & Design are registered trademarks of AutoZone Parts, Inc. ASE Certified is a trademark of the National Institute for Automotive Service Excellence (ASE). All other marks are the property of their respective holders.

For More Information
(888) 726-3211

ALLDATA[®]
 An AutoZone[®] Company

LIGHTING

TOOL of the MONTH **JUNE**
SEE INSERT FOR DETAILS

NEW

OEM TOOLS®

400 Lumens
3-in-1 Multi-Use Rechargeable
Diagnostic Work Light

SKU 591153
24609 **109⁹⁹**

- 5 Hr. Run Time on High
- Length: 13.4" Smoke Detection Light

Three Lights In One



LCD Displays Battery Charge

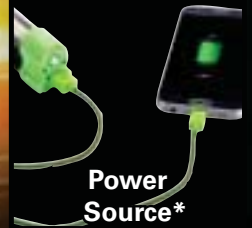

Power Source*



UV Detection Light



Bright White Light



*Charges Cell Phones, Tablets and Hand Held Devices

1000 Lumens
Rechargeable
Multi-Use Work Light
SKU 850228
24604 **199⁹⁹**
• 9 Hr. Run Time on High
• Length: 23.6"

600 Lumens
Rechargeable
Multi-Use Work Light
SKU 822266
25997 **69⁹⁹**
• 6 Hr. Run Time on High
• Length: 13.4"

200 Lumens
Rechargeable
Multi-Use Work Light
SKU 105545
24603 **39⁹⁹**
• 3 Hr. Run Time on High
• Length: 6"

330 Lumens
Rechargeable
Multi-Use Work Light
SKU 105560
24605 **49⁹⁹**
• 4 Hr. Run Time on High
• Length: 8.5"

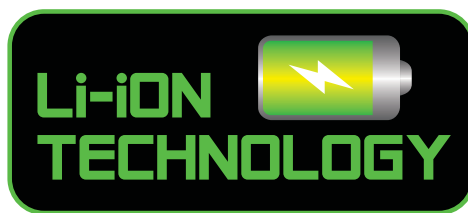

FEATURES

- Magnetic Back Attaches to Any Ferrous Metal Surface to Hold the Light in Place
- Li-Ion Technology Holds Charge for a Longer Run Time
- Comes with Universal Micro USB Cable to Charge Anywhere
- 5 Light Modes to Maximize Run Time: High/Medium/Low/Strobe/S.O.S.
- Bright and Efficient LED Bulbs to Give Higher Run Time with Greater Output
- Lightweight and Compact Size for Easy Transportation
- Charging Indicator Lights: Red (Charging), Green (Fully Charged) and Yellow (20% Battery Remaining)

OEM TOOLS®

REVOLUTIONARY LUMINATION

MULTIPLE USES



Underhood



Home



Garage/Shop



Roadside Emergency

LIGHT ACCESSORY KIT

SKU 435496
24608 **19⁹⁹**

INCLUDES:



- Rubber End Casings**
- Non-Marring End Casings
 - Use with Magnetic Adhesive Pads on Non-Ferrous Surfaces
 - 2 Pack



- Hanging & Pivoting Hooks**
- Pivots 180°
 - 2 Pack



- Magnetic Adhesive Pads**
- Ideal for Non-Ferrous Metal Surface



- Hanging Strap**
- Nylon Strap
 - Adjustable Lengths



Contact Us:
1-877-AZTool1 Phone
 (1-877-298-6651) *Hablamos Español*

Rechargeable Flashlights

Rechargeable Pen Light with Focus

SKU **592181** **49⁹⁹**
 32830 (Black)

- Rotating Focus System and Magnetic Base
- 2 Modes: Low (50 Lumens) and High (100 Lumens)
- Battery Runtime: 5 Hours (Low), 2.5 Hours (High)
- Anodized Aluminum Body is Impact Resistant to 1 Meter
- Charging Indicator Lights: Charging (Red) and Fully Charged (Green)
- 80 Meter Beam Distance
- Weight: 3.2 Oz.
- Dimensions: 5.875" x 0.75"



NEW

GreatLite

(Blue) SKU **592177** 32831 (Red) SKU **592179** 32833
 (Green) SKU **592178** 32832 (Silver) SKU **592182** 32834

E36 Cree Rechargeable Flashlight Kit

SKU **568461** **59⁹⁹**
 EXPE36-E02

- Dimensions: 5.4" (L) x 0.9" (D) x 1.1" (Head)
- Beam Distance: 300m
- Impact Resistance: 1.5m
- Water Resistant: IPX-6
- Comes with (1) 18650 Battery and Charger



800 LUMENS **MAX RUN TIME 2hrs**

GreatLite
 Our Brightest Light!

E36 Cree Rechargeable Flashlight Only

SKU **568460** **54⁹⁹**
 EXPE36 (Comes with (2) CR123A Batteries. Rechargeable Batteries and Charger Sold Separately)

E87 Rechargeable Flashlight

SKU **568466** **59⁹⁹**
 EXPE87-E02

- Dimensions: 5.4" (L) x 1.0" (D) x 1.4" (Head)
- Beam Distance: 200m
- Impact Resistance: 1.5m
- Waterproof: IPX-8
- Comes with (1) 18650 Battery and Charger



500 LUMENS **MAX RUN TIME 2hrs**

GreatLite

Adjusts to 5 Light Modes: 500LM, 190LM, 35LM, STROBE and S.O.S.

E81 Cree LED Tactical Flashlight Kit

SKU **462479** **74⁹⁹** **SAVE \$5**
 EXPE81-E02 REG. \$79.99

- Dimensions: 6.30" (L) x 1.06" (D) x 1.96" (Head)
- Beam Distance: 200m
- Impact Resistance: 1.5m
- Waterproof: IPX-8
- Comes with (1) 18650 Battery and Charger



500 LUMENS **MAX RUN TIME 3hrs**

GreatLite

E81 Cree LED Tactical Flashlight Only

SKU **347207** **59⁹⁹**
 EXPE81 (Comes with (2) CR123A Batteries. Rechargeable Batteries and Charger Sold Separately)

Offer Good Through June 30, 2017 - While Supplies Last

E67 Cree LED Tactical Flashlight Kit

SKU **462478** **59⁹⁹**
 EXPE67-E02

- Dimensions: 5.51" (L) x 1.04" (D) x 1.37" (Head)
- Beam Distance: 200m
- Impact Resistance: 1.5m
- Waterproof: IPX-8
- Comes with (1) 18650 Battery and Charger



400 LUMENS **MAX RUN TIME 3hrs**

GreatLite

E67 Cree LED Tactical Flashlight Only

SKU **347205** **47⁹⁹**
 EXPE67 (Comes with (2) CR123A Batteries. Rechargeable Batteries and Charger Sold Separately)

E54 Cree LED Tactical Flashlight Kit

SKU **462477** **89⁹⁹** **SAVE \$10**
 EXPE54-E01 REG. \$99.99

- Dimensions: 19.9" (L) x 1.04" (D) x 1.37" (Head)
- Beam Distance: 300m
- Impact Resistance: 1.5m
- Waterproof: IPX-8
- Comes with (2) 18650 Batteries and Charger



700 LUMENS **MAX RUN TIME 3hrs**

GreatLite

Offer Good Through June 30, 2017 - While Supplies Last

Strion® Rechargeable LED Flashlight with AC/DC Charger

SKU **295851** **179⁹⁹**
 STL74301 Black

- Rechargeable, Ultra-Compact and Powerful, the Strion LED Offers Three Variable Intensity Modes, Strobe Mode and the Latest in Power LED Technology
- C4® LED Technology for Extreme Brightness
- Impervious to Shock, 50,000 Hour Lifetime
- Light Output: High: 260 Lumens; Medium: 130 Lumens; Low: 65 Lumens



Stinger® Rechargeable LED Flashlight with AC/DC PiggyBack Charger

SKU **291368** **209⁹⁹**
 STL75732 Black

- Combination of Rechargeability and C4® LED Technology That Produces the Lowest Operating Cost of Any Flashlight Made!
- Ultra-Bright, Far-Reaching Beam Offers Multiple Light Modes, Including Strobe
- 3 Watt Super High Flux LED, Impervious to Shock with a 20,000 Hour Lifetime
- Run Time: High Beam: Up to 1.75 Continuous Hours; Medium Beam: Up to 3.5 Continuous Hours; Low Beam or Strobe: Up to 6.75 Continuous Hours
- Light Output: High: 350 Lumens; Medium: 175 Lumens; Low: 85 Lumens



Rechargeable Batteries

3.7 Volt 18650 Rechargeable Battery

SKU **347210** **19⁹⁹**
 EXPE03

3.7 Volt Li-Ion Battery

SKU **535222** **19⁹⁹**
 EXPE04

Charging Unit for (1) 18650 Battery

SKU **347209** **29⁹⁹**
 EXPE02

- Comes with (1) 18650 Battery

Charging Unit for (2) 18650 Batteries

SKU **347208** **59⁹⁹**
 EXPE01

- Comes with (2) 18650 Batteries

GreatLite

Headlamps

E51 Cree LED Multi-Function Headlight

SKU **347231** **21⁹⁹** **HANDS FREE ON/OFF**
 EXPE51

- Dimensions: 2.36" (L) x 2.0" (D) x 1.57" (H)
- Beam Distance: 35m
- Impact Resistance: 1.5m
- Water Resistant: IPX-6
- Comes with (3) AAA Duracell® Batteries
- (1) White Light CREE XP-LED Bulb and (2) Red LED Bulbs



160 LUMENS **MAX RUN TIME 3hrs**

GreatLite

E86 Headlight and Flashlight

SKU **568465** **29⁹⁹**
 EXPE86

- Dimensions: 3.3" (L) x 0.7" (D) x 0.9" (Head)
- Beam Distance: 15m
- Impact Resistance: 1.5m
- Water Resistant: IPX-6
- Comes with (1) AA Duracell® Battery
- Includes Headband, (2) Headlight Cradles: Black and Glow-in-the-Dark



100 LUMENS **MAX RUN TIME 1hr**

GreatLite

Enduro® LED Headlamp

SKU **291379** **27⁹⁹**
 STL61400

- Impact Resistant ABS Case and Polycarbonate Lens
- (1) Super High Flux LED, 100,000 Hour Life
- Run Time: Low Beam (10%) Up to 12 Hours, High Beam (100%) Up to 6 Hours at Regulated Intensity
- Light Output: High 14.5 Lumens; Low 6 Lumens
- Includes Clip, Strap and Alkaline Batteries



HL5 LED Headlamp

SKU **762478** **19⁹⁹**
 TT7041CP

- Lumens: 175
- Beam distance: 183 feet
- Run Time: 3+ Hours
- Bulb type: LED
- Battery size: 3 x AAA



Tire Kicker Light

16.25" Tire Kicker and High Performance Bat Light (Black)

SKU **432100** **24⁹⁹** **SAVE \$5**
 32818 (Black) REG. \$29.99

- Dimensions: 16.25" (L) x 1.25" (D)
- Beam Distance: 150m
- Impact Resistance: 1.5m
- Water Resistant: IPX-4
- Comes with (4) AA Batteries
- CREE XP-G Bulb



200 LUMENS **MAX RUN TIME 72hrs**

GreatLite

SKU **467250** 32819 (Red)
 SKU **467251** 32820 (Grey)

GreatLite

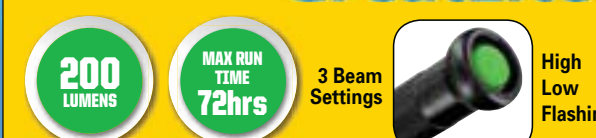

Offers Good Through June 30, 2017 - While Supplies Last

LIGHTING

Standard LED Flashlights

Periscope LED Flashlight

SKU 526504
25458 **14⁹⁹**

- Beam Distance: 2m
- Impact Resistance: 1.5m
- Water Resistant: IPX-3
- Comes with (2) AA Batteries



60 LUMENS
MAX RUN TIME 6hrs

OEM TOOLS

100 Lumen Cree-R5 Flashlight

SKU 544811
24460 **17⁹⁹**

- Beam Distance: 80m
- Water Resistant: IP44
- Comes with (1) AA Battery
- (3) Light Modes: 100% for 100 Lumens, 50% for 50 Lumens, Flash Mode
- CREE-R5 (XPG) Bulb



100 LUMENS
MAX RUN TIME 1hr

OEM TOOLS

220 Lumen Cree-R5 Flashlight

SKU 544813
24461 **19⁹⁹**

- Beam Distance: 100m
- Water Resistant: IP44
- Comes with (2) AA Batteries
- (3) Light Modes: 100% for 220 Lumens, 50% for 110 Lumens, Flash Mode
- CREE-R5 (XPG) Bulb



220 LUMENS
MAX RUN TIME 1.5hrs

OEM TOOLS

E61 Every Day Flashlight

SKU 347202
EXPE61 **19⁹⁹**

- Dimensions: 3" x 1/2" (Head Diameter)
- Beam Distance: 15m
- Impact Resistance: 1.5m
- Water Resistant: IPX-4
- Comes with (1) AAA Battery



80 LUMENS
MAX RUN TIME 1hrs

GreatLite

CREE LED Pen Light

SKU 592184
32835 (Black) **19⁹⁹**

- Comes with (2) AAA Panasonic® Batteries and Tactical Clip
- 3 Modes: Low (50 Lumens), High (150 Lumens) and Strobe
- Battery Runtime: 6 Hours (Low), 3 Hours (High)
- 80 Meter Beam Distance
- Anodized Aluminum Body is Impact and Water Resistant
- Dimensions: 5.7" (L) x 0.6" (D)
- Weight: 1.6 Oz.



150 LUMENS
MAX RUN TIME 3hrs

GreatLite

G26 LED Flashlight

SKU 762486
19680 **19⁹⁹**

- Lumens: 120
- Beam distance: 104 feet
- Run Time: 3+ Hours
- Bulb Type: LED
- Battery Size: 2 x AA



120 LUMENS
MAX RUN TIME 3hrs

COAST

Your "EVERY DAY CARRY" Light

E33 Cree LED Professional Focus Flashlight

SKU 568458
EXPE33 **29⁹⁹**

- Dimensions: 4.4" (L) x 0.7" (D) x 1.0" (Head)
- Beam Distance: 30m
- Impact Resistance: 1.5m
- Water Resistant: IPX-4
- Comes with (1) AA Duracell® Battery



80 LUMENS
MAX RUN TIME 1.5hrs

GreatLite

E82 Cree LED Professional Pocket Flashlight

SKU 568462
EXPE82 **34⁹⁹**

- Dimensions: 4.2" (L) x 0.9" (D) x 0.9" (Head)
- Beam Distance: 30m
- Impact Resistance: 1.5m
- Waterproof: IPX-8
- Comes with (1) AA Duracell® Battery



100 LUMENS
MAX RUN TIME 1.2hrs

GreatLite

E31 Cree LED Professional Focus Flashlight

SKU 568456
EXPE31 **34⁹⁹**

- Dimensions: 5.28" (L) x 1.1" (D) x 1.5" (Head)
- Beam Distance: 200m
- Impact Resistance: 1.5m
- Water Resistant: IPX-4
- Comes with (3) AAA Duracell® Batteries



230 LUMENS
MAX RUN TIME 4hrs

GreatLite

E32 Cree LED Professional Focus Flashlight

SKU 568457
EXPE32 **34⁹⁹**

- Dimensions: 6.36" (L) x 0.73" (D) x 1.04" (Head)
- Beam Distance: 30m
- Impact Resistance: 1.5m
- Water Resistant: IPX-4
- Comes with (2) AA Duracell® Batteries



120 LUMENS
MAX RUN TIME 2hrs

GreatLite

E83 Cree LED Professional Pocket Flashlight

SKU 568463
EXPE83 **39⁹⁹**

- Dimensions: 6.0" (L) x 0.9" (D) x 0.9" (Head)
- Beam Distance: 30m
- Impact Resistance: 1.5m
- Waterproof: IPX-8
- Comes with (2) AA Duracell® Batteries



200 LUMENS
MAX RUN TIME 1.5hrs

GreatLite

E84 Cree LED Professional Stubby Pocket Flashlight

SKU 568464
EXPE84 **39⁹⁹**

- Dimensions: 3.5" (L) x 0.9" (D) x 0.9" (Head)
- Beam Distance: 30m
- Impact Resistance: 1.5m
- Waterproof: IPX-8
- Comes with (1) CR123A Battery



200 LUMENS
MAX RUN TIME 15hrs

GreatLite

E65 Cree LED Tactical Flashlight

SKU 347203
EXPE65 **49⁹⁹**

- Dimensions: 6.85" (L) x 1.36" (D) x 1.71" (Head)
- Beam Distance: 300m
- Impact Resistance: 1.5m
- Waterproof: IPX-8
- Comes with (2) C Duracell® Batteries



400 LUMENS
MAX RUN TIME 2hrs

GreatLite

E30 Cree LED Professional Focus Flashlight

SKU 568454
EXPE30 **49⁹⁹**

- Dimensions: 8.88" (L) x 1.22" (D) x 1.72" (Head)
- Beam Distance: 300m
- Impact Resistance: 1.5m
- Water Resistant: IPX-4
- Comes with (3) C Duracell® Batteries



580 LUMENS
MAX RUN TIME 10hrs

GreatLite

E66 Cree LED Flashlight

SKU 347204
EXPE66 **64⁹⁹**

- Dimensions: 10.2" (L) x 1.7" (D) x 2.2" (Head)
- Beam Distance: 300m
- Impact Resistance: 1.5m
- Water Resistant: IPX-4
- Comes with (2) D Duracell® Batteries



500 LUMENS
MAX RUN TIME 3hrs

GreatLite



Contact Us:
1-877-AZTool1 Phone
 (1-877-298-6651) *Hablamos Español*

Work Lights

3W CREE Rechargeable Li-Ion Pocket Light

SKU 819643 **24⁹⁹**
 25980 REG. \$29.99

- 5 SMD LED Super Bright Work Light – 200 Lumens
- CREE 3W LED Spot Light – 100 Lumens
- 3.7V 1000 mAh 14650 Li-Ion Battery
- Powerful Magnetic Pocket Clip

SAVE \$5

200 LUMENS

MAX RUN TIME 4hrs

Offer Good Through June 30, 2017 While Supplies Last



Inspection Lights

One Flashlight Body with 2 Interchangeable Heads

Pro 500 Lumen Rechargeable Flashlight with 450 Lumen Ultra Slim Inspection Light

SKU 798710 **79⁹⁹**
 32827

- Dimensions: Flashlight 6.5 In. (L) x 1.3 In. (D) x 1.1 In. (H) Inspection Light 7.9 In. (L) x 0.9 In. (D) x 1.2 In. (H)
- Beam Distance: Flashlight 170m, Inspection 30m
- Impact Resistance: 1m
- 5 Light Modes: 100%, 50%, 25%, Strobe and S.O.S.
- Includes USB Charging Cord with UL Adapter and (1) 18650 Rechargeable Battery



USB Rechargeable

500 LUMENS FLASHLIGHT

450 LUMENS INSPECTION

MAX RUN TIME 3.5hrs



Attachable 360° Hook for 32827 Light

SKU OUTSIDE BUY/EPO **9⁹⁹**
 32829



Rotates 360°

Mechanic's 500 Lumen Rechargeable Flashlight and 450 Lumen Ultra Slim Wand with UV Inspection

SKU 344835 **89⁹⁹**
 24607

- Recharge Anywhere with Micro USB Charger
- Five Light Modes: 100%, 50%, 25%, Strobe and S.O.S.
- Comes with Attachable 360° Hook. Shine Your Light in Any Direction You Need.
- Flashlight Head Can Be Removed and Replaced with the Slim Inspection Light (as Shown)



Includes Hook & Rechargeable Battery

500 LUMENS FLASHLIGHT

450 LUMENS INSPECTION

MAX RUN TIME 3.5hrs



A Perfect Light for the Mechanic.

Rotates 360°

UV Lights

USB Rechargeable

7 LED Rechargeable Work Light

SKU 819644 **49⁹⁹**
 25982

- 3W COB LED, Super Bright White Lights: 210 Lumens
- 7 LED Torch Light
- 3.7V 2200 mAh Li-Ion Battery
- Runtime: 3 Hrs. (Work Light), 20 Hrs. (Torch Light)
- Cordless, Rechargeable
- Powerful Magnets on the Back and Swivel Base
- Over-Charge and Discharge Protection
- Recharge Using USB Cable (Included)



Swivels, Hang, or Stick

210 LUMENS

MAX RUN TIME 3hrs



130 Lumen LED Work and Flashlight

SKU 544810 **29⁹⁹**
 24602

- Beam Distance: 85m
- Impact Resistance: 1.5m
- Water Resistant: IP45
- Comes with (3) AA Batteries



130 LUMENS WORKLIGHT

MAX RUN TIME 2.5hrs

60 LUMENS FLASHLIGHT



140 Lumen Pop Open LED Work and Flashlight

SKU 544808 **34⁹⁹**
 24601

- Beam Distance: 85m
- Impact Resistance: 1.5m
- Water Resistant: IP45
- Comes with (4) AAA Batteries



140 LUMENS WORKLIGHT

MAX RUN TIME 3.5hrs

55 LUMENS FLASHLIGHT



DID YOU KNOW?

AutoZone® carries over 30 part numbers of Power Sports Batteries. These fit motorcycles, ATVs/UTVs, snowmobiles and personal watercraft.

Contact Your AutoZone Commercial Sales Manager for Pricing

36 LED Rechargeable Work Lamp

SKU 210205 **36⁹⁹**
 33006

- 4.8 Volt Rechargeable Battery, Recharges in 2 - 3 Hours
- Includes AC / DC Charging Adapters
- Powerful Magnet on Back
- Hanging Hook for Hands-Free Operation



66 LUMENS

MAX RUN TIME 2.5hrs



Handheld Fluorescent Lights

- Heavy Duty End Caps with Shatterproof Casing
- 360° Rotating Hook
- 15' Cord



13 Watt SKU 914625 | 25983 **39⁹⁹**

26 Watt SKU 915801 | 25984 **49⁹⁹**



500 Watt Single Head Tripod Halogen Work Light

SKU 291350 **39⁹⁹**
 32771

- 500 Watt Halogen
- 10,000 Lumens
- 1,000 Hr. Runtime



24 LED Rechargeable Work Light

SKU 526512 **59⁹⁹**
 32775

- 24 Super Bright LED Lights
- Beam Distance: 30m
- Water Resistant: IP4
- Includes: AC/DC 120 Volt Adapter with USB Port and 12V DC Car Charger
- Li-Ion Battery



700 LUMENS

MAX RUN TIME 4hrs



Heavy Duty Reel with T-Tap

SKU 133483 **199⁹⁹**
 25994

- Clear Tri-Tap Illuminates When Receiving Power
- Fully Enclosed Safety Switch, Full Overload Protection
- Hardware Included for Wall or Ceiling Mounting
- Adjustable Ball-Check Stop
- 50' Cord
- 12 Amp Rating



While Supplies Last



Bounce Lite® 13 Watt Work Light with 25' Cord

SKU 186474 **64⁹⁹**
 CEN12006

- 25' 18/2 HD Power Cord
- Bounces Instead of Breaking - Features Patented Bounce-Bulb Technology
- Heavier Housing and End Caps for Improved Durability
- Fully Enclosed Safety Switch
- Superior Cord Life



Bounce Lite® 13 Watt Work Light with 50' Cord

SKU 186475 **109⁹⁹**
 CEN12007

- 50' 18/2 HD Power Cord

Bounce Lite® Reel and Light

SKU 186477 **189⁹⁹**
 CEN12010

- Patented Bounce-Bulb Shock Technology Protects Bulb When Light is Dropped
- 40' Oil and Water Resistant 18/2 Gauge SJTOW 110 Volt Power Cord
- Heavy Duty Swivel Hook and Fully Enclosed Safety Switch



SKU 186476 **139⁹⁹**
 CEN12009

- 25' Oil and Water Resistant 18/2 Gauge SJTOW 110 Volt Power Cord

Bounce Lite® Bulbs

SKU 186480 **22⁹⁹**
 CEN1100617

- Replacement Bulbs for CEN12009 and CEN12010



25 Watt Underhood Lite® and LitePerch®

SKU 186479 **199⁹⁹**
 CEN13003

- Hands-Free Lighting of Entire Engine Compartment
- Works on All Passenger Cars and Light Trucks
- 25' 18/2 Heavy Duty Power Cord
- LitePerch Opens: 4' to 6.6'



3 Pack Underhood Light® Bulbs

SKU 186481 **79⁹⁹**
 CEN1056026



BATTERY SERVICE

JUMP STARTERS
AND PERSONAL
POWER BANKS

PPS-X
WITH
SMART JUMP CABLES

Li/18000 mAh

OEM TOOLS

PPS-X Li-Ion Jump Starter and Power Bank with "Smart Jump Cables"

SKU 568481 | 24455

139⁹⁹
REG. \$199.99

SAVE
\$60

For Heavy Duty Use

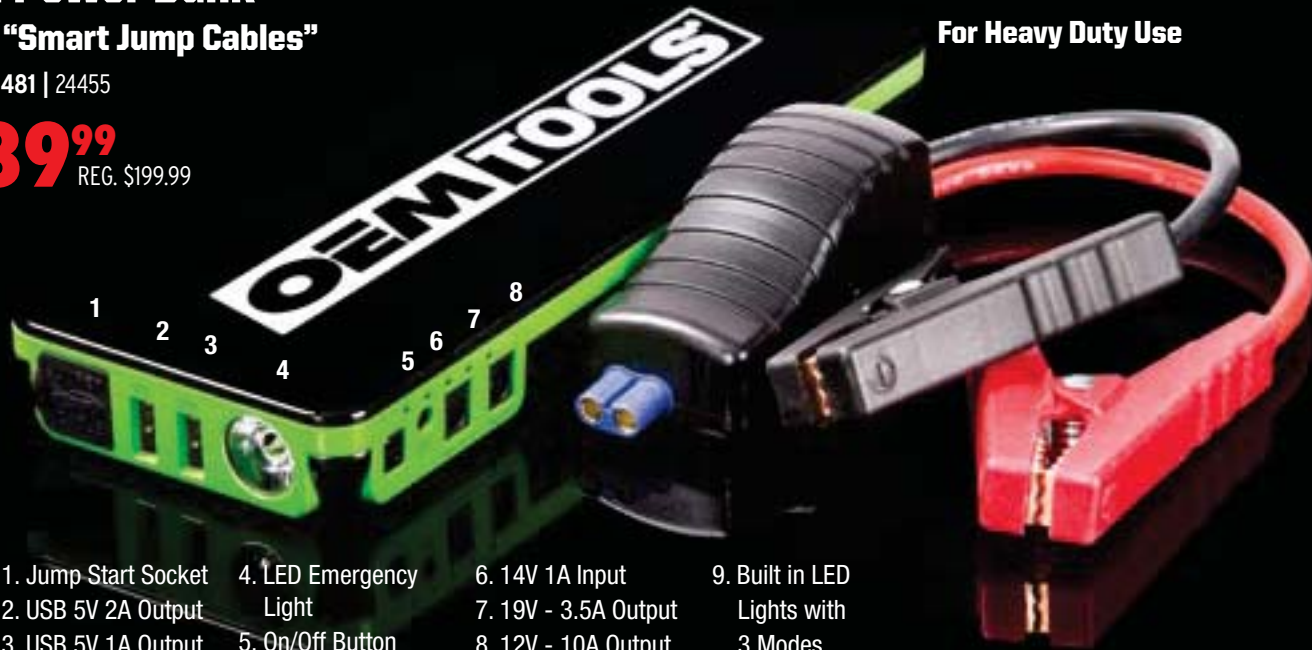

Charge Your Phone, Tablet or Laptop



Holds Charge Up to 12 Months without Recharging



Intelligent Cables That Verify Proper Connection, Making Jump Starting Easy and Safe



Jump Start a V8 Engine

- | | | | |
|----------------------|------------------------|----------------------|-------------------------------------|
| 1. Jump Start Socket | 4. LED Emergency Light | 6. 14V 1A Input | 9. Built in LED Lights with 3 Modes |
| 2. USB 5V 2A Output | | 7. 19V - 3.5A Output | |
| 3. USB 5V 1A Output | 5. On/Off Button | 8. 12V - 10A Output | |

Offer Good Through June 30, 2017 - While Supplies Last

PPS-1 Li-Ion Power Bank and Car Jump Starter with "Smart Jump Cables"

SKU 568483 24379 **89⁹⁹**
REG. \$99.99

- Built-In LED Lights with 3 Modes

SAVE
\$10

OEM TOOLS

Li/8000 mAh

Travel Safely and Be Ready for Any Emergency! Jump Starts a Car Up to 20 Times and Charges Smartphones and Tablets



Offer Good Through June 30, 2017 - While Supplies Last

Multi-Use Li-Ion Jump Starter and Power Bank

SKU 533208 24370

139⁹⁹

- Built-In LED Lights with 3 Modes

OEM TOOLS

Li/12000 mAh

Perfect for the Technician

Jump Starts a V6 Up to 20 Times, 95% Lighter Than Lead Acid Jump Starters



Replacement "Smart Jump Cables" for PPS-1

SKU 568482 24456 **22⁹⁹**

- Intelligent Cables That Verify Proper Connection, Making Jump Starting Easy and Safe. Use with OEMTOOLS PPS-1 Personal Power Source #24379.



OEM TOOLS

Intelligent Cables That Verify Proper Connection, Making Jump Starting Easy and Safe

Replacement "Smart Jump Cables" for Personal Power System PPS-X

SKU 568470 24457 **24⁹⁹**

- Intelligent Cables That Verify Proper Connection, Making Jump Starting Easy and Safe. Use with OEMTOOLS PPS-X Personal Power Source #24455.



OEM TOOLS

OBD-II Memory Saver

SKU 555447 24453 **39⁹⁹**

- Plugs Directly Into the Vehicle's OBD-II Port
- Includes: Power Plug to OBD-II Connector Adaptor Lead
- Replaceable Fuse to Protect Sensitive Vehicle Components from Damage
- Works with OEMTOOLS PPS-1 Personal Power Source #24379, 24370 and 24454



PPS-Maritime Jump Starter and Power Bank with Waterproof Storage Case

SKU 568480 24454 **149⁹⁹**

- Same as OEMTOOLS 24370 with a Waterproof Case

OEM TOOLS

Sturdy, Water-Tight Case Perfect for Marine and Outdoor Use

Li/12000 mAh



DID YOU KNOW?

AutoZone® carries vehicle make specific body fastener kits.

Contact Your AutoZone Commercial Sales Manager for Details



Contact Us:
1-877-AZTool1 Phone
 (1-877-298-6651) *Hablamos Español*

Battery Testers

Digital Battery Analyzer

SKU 819073
 24359 **54⁹⁹** REG. \$64.99

- Tests Battery, Starting and Charging Systems
- Clear and Easy to Understand Results to Indicate System's Condition
- Battery CCAs: 200-1200
- Voltage: 7-15VDC
- Testing Standards: SAE, DIN, EN, IEC, CA

SAVE \$10



Offer Good Through
 June 30, 2017
 While Supplies Last

Professional Battery Tester

SKU 544740
 24369 **79⁹⁹** REG. \$99.99

- Easy to Understand Menu-Driven Testing for Battery, Starting and Charging Systems
- Battery CCAs: 240 - 2,000
- Includes Fast Test Mode

SAVE \$20



Offer Good Through
 June 30, 2017
 While Supplies Last

Battery Tester HH 6/12V 135A

SKU 496662
 ASC6026 **99⁹⁹**

- Tests Both 6/12 Volt Batteries
- Tests Alternators and Starters
- 300 Amp Vinyl Coated Clamps
- 1-Year Warranty



ASSOCIATED

110 Amp Battery Tester

SKU 434261
 ASC6031 **219⁹⁹**

- Semi-Automatic Battery, Starter, Alternator Tester
- Performs State of Health for Conventional and Maintenance Free Batteries
- Built in Side Terminal Adapters
- Made in USA with 1-Year Warranty



ASSOCIATED

Digital Electrical System Analyzer Tester

SKU 343372
 ASC12-1012 **299⁹⁹**

- Lightweight Hand-Held Conductance Digital Battery Tester with USB Port Tests Battery, Starter and Alternator on 12V Systems



ASSOCIATED

Battery Conductance Tester

SKU 291330
 MIDPBT100 **199⁹⁹**

- Tests Both the Starter and the Charging System
- Tests 12V Automotive Batteries from 200 - 850 CCAs
- Durable Design for the Workshop or in the Field



MIDTRONICS Advancing Battery Management

Advanced Diagnostic Battery Conductance/ Electrical System Tester

SKU 291329
 MIDPBT300 **369⁹⁹**

- Tests 12V Automotive Batteries from 100 - 1,400 CCAs
- Voltmeter Mode for Testing Both Starter and Charging Systems
- Accurate Battery Test Decisions in Seconds



MIDTRONICS Advancing Battery Management

Digital System Analyzer Tester w/ Printer

SKU 343373
 ASC12-1015 **429⁹⁹**

- Volt Meter 5-91 Volts
- Stores Last Test Series
- 10 Line LCD Display
- Battery, Starter and Alternator Tests
- Carrying Case Included



ASSOCIATED

12V Battery and Electrical System Tester with Built-In Printer

SKU 291331
 MIDMDXP300 **699⁹⁹**

- Tests 12V Batteries from 100 to 1400 CCA, Including AGM and Gel
- Integrated Printer Allows Immediate Printing of Test Results



MIDTRONICS Advancing Battery Management

6 and 12V Battery and Electrical System Tester for HD/Fleet with Integrated Printer

SKU 291334
 MIDMDX700PHD **1,399⁹⁹**

- Applications: 6V and 12V Batteries and 12V and 24V Charging Systems
- Battery Types: Flooded, AGM, AGM Spiral and Gel
- Vehicle Applications: Group 31, Automotive, Motorcycle, Marine Cranking, Lawn and Garden and Commercial 4D/8D Batteries



MIDTRONICS Advancing Battery Management

Battery Chargers

Fast Charger Cranking Assist

SKU 344795
 ASCUS20 **399⁹⁹**

- 40 Amp Continuous Rating at 6/12 Volts
- Manufacturer's Boost Rating 330 Amps
- 90 Minute Timer with Hold
- Fan Cooling Mechanism Prevents Overheating



Professional Fast Charger Cranking Assist

SKU 496661
 ASC6012 **599⁹⁹**

- 6/12 Volt, 70/60 Amp Output
- 250 Amp Crank Assist
- Fan Cooling Mechanism Prevents Overheating



6/12/24-Volt Heavy Duty Fast Charger

SKU 444366
 ASC6006 **799⁹⁹**

- 12 Volt, 70 Amp Output
- 250 Amp Crank Assist
- UL Rated Safe in Any Weather, Indoor / Outdoor Approved
- Made in USA, 5-year Limited Warranty



60 Amp/270 Amp Intellamatic Boost Wheel Battery Charger and Power Supply

SKU 344790
 ASCESS6008 **999⁹⁹**

- DC Output 60 Amps /70 amps in Power Supply Mode
- DC Leads 6 1/2' 6.5 AWG
- Clamp Rating 400A
- Limited Warranty Three Years
- Shipping Dimensions 23"x19"x16"
- Weight 49 LBS
- AC Cord / Voltage 6' 16-3 / 120VAC 60 Hz
- Battery Types 12 Volt Flooded, AGM, and Gel Cell Batteries - Including Spiral Cell, Orbital, or Optima Batteries



ASSOCIATED
 Made in USA
 Safe in Any Weather

12Volt, 45A Intellamatic Pro Wheel Charger

SKU 343370
 ASCESS6007B **799⁹⁹**

- Charges All Types of 12V Batteries
- Dead Battery Override Control
- All Weather Safe
- Made In USA



6/12-Volt Commercial Charger

SKU 496657
 ASC6001A **864⁹⁹**

- 6/12 Volt, 100 /75 Amp Output
- 375 Amp Crank Assist
- UL Rated Safe In Any Weather
- Made in USA
- 5-year Limited Warranty



6/12/18/24-Volt Commercial Charger

SKU 221248
 ASC6002B **919⁹⁹**

- 6/12/24 Volt, 100/80/50/40 Amp Output
- 400 Amp Crank Assist
- UL Rated Safe in Any Weather, Indoor / Outdoor Approved
- Made in USA, 5-Year Limited Warranty



Smart Chargers

It is important to use Smart Chargers when charging AGM Batteries. Standard Battery Chargers will not fully charge AGM Batteries and can shorten their life.

6/12V, 12/2/50A Fully Automatic Smart Charger

SKU 850633
 ASC3055A **149⁹⁹**

- LED Display Indicates Charge Current, % Charged
- Charges AGM/GEL/SLA and Deep Cycle Battery Types
- 50 Amp Engine Start Feature for 12V Application



ASSOCIATED

6/12V, 12/2/75A Fully Automatic Smart Charger

SKU 850632
 ASC3075A **159⁹⁹**

- Charges AGM/GEL/SLA and Deep Cycle Battery Types
- 75 Amp Engine Start Feature for 12V Application
- Automatic Bad Battery Detection



6/12V, 15/2/100A Fully Automatic Smart Charger

SKU 850634
 ASC3100A **169⁹⁹**

- Charges AGM/GEL/SLA and Deep Cycle Battery Types
- 100 Amp Engine Start Feature for 12V Application
- Automatic Bad Battery Detection



Jump Starters

Kwikstart® 12 Volt Portable Power and Jump Start

SKU 850637
 ASC6256 **199⁹⁹**

- Peak Amp Output: 1700 Amps
- USB Port
- (2) 12 Volt DC Accessory Outlets to Power and/or Recharge DC Electronics
- 32" Heavy Duty Cables



CCA: 360

KS400 KwikStart® Jump Starter

SKU 850635
 ASCK400G **289⁹⁹**

- Exclusive Heavy Duty 22Ah Sealed AGM Battery Provides Powerful "Best-In-Class" Performance
- Replaceable Field Serviceable Cables and Battery
- Built-In Digital Voltmeter, 12V Power Port and USB Power Port



CCA: 360

DID YOU KNOW?

AutoZone® has the starting battery for 2002 - 2014 Toyota Prius.

Contact Your AutoZone Commercial Sales Manager for Details

BATTERY SERVICE

Battery Testers

Digital Tester

SKU 240416
BT175 **69⁹⁹**

- For testing 12 volt batteries, up to 1200 cold cranking amps, battery state of charge, battery cranking ability, charging system output, starter motor draw
- Accurate, easy-to-read LED screen.
- Four LED indicators



Digital Tester

SKU 747180
BTF-250 **139⁹⁹**

- 12 Volt Digital Battery Tester
- Checks both battery and charging system
- Bright digital display - indicates both voltage and test results
- Unique 5-step design - indicates OK, OK & Recharge, Recharge Battery, Recharge & Retest, Bad Cell
- Error LED indicates Reverse hook-up
- Super-Grip battery clamps



ProSeries Tester w/ Printer

SKU 112548
PST-900X **499⁹⁹**

- 3 Tests in 1
- Tests 6V & 12V Batteries
- Tests 12V & 24V Charging Systems
- Works with Standard & AGM Batteries
- Easy to Operate
- Battery | Starting | Charging



Wheel Chargers

Oversized heavy-duty switches, precision timer-controlled operation, large face clear-view amp and volt meters, tubular steel-plated handles with rubber grips, handles are commercial grade, welding grade, high volume cooling fan and heavy-duty steel cabinets with wide-track wheels.



DSR PROSERIES
POWERED BY SCHUMACHER

Model	Auto or Manual Charging	Charging Voltages	Charging Rates	Engine Start Rating	Price
PSW-2550 SKU 837564	Manual	6V, 12V	50/10 Amps	125/250 Amps (6/12V)	249⁹⁹
PSW-3060 SKU 837565	Manual	6V, 12V	60/30/4 Amps	200/300 Amps (6/12V)	429⁹⁹
PSW-70300A SKU 058087	Automatic & Manual Modes	12V	70/20/4 Amps	300 Amps (12V Only)	349⁹⁹
PSW-61224 SKU 837566	Manual	6V, 12V, 24V	60/35/1.5 Amps	150/250/150 Amps (6/12/24V)	379⁹⁹

Heavy Duty Chargers

DSR INDUSTRIAL
POWERED BY SCHUMACHER



4-Battery Charging Station

SKU 069531
INC-406A **249⁹⁹**

- Charge up to 4 Batteries at a time
- Works on 6V & 12V Batteries
- Includes 4 sets of 72" Leads
- Fully Automatic Operation
- 6A output per bank
- Separate LED battery status indicator for each bank



8-Battery Charging Station

SKU 069532
INC-812A **649⁹⁹**

- Charges Standard & AGM 12V Batteries
- Digital Display Shows Charging status
- Includes 8 sets of 72" leads
- Fully Automatic Operation
- 12/2A output per bank
- 8 completely independent charging banks

DSR products are designed with commercial-grade heavy-duty construction and have patented, state-of-the-art charging, testing and safety technologies, built-in for ease of use and functionality

Jump Starters/Portable Power

DSR PROSERIES
POWERED BY SCHUMACHER



Model	Peak Amps	Charging Voltages	CA	High Output Batteries	Price
PSJ-1812 SKU 747157	1800	12V	280	1	149⁹⁹
PSJ-2212 SKU 069586	2200	12V	330	1	199⁹⁹
PSJ-3612 SKU 362531	3600	12V	470	2	349⁹⁹
PSJ-4424 SKU 069587	4400	12V, 24V	500	2	499⁹⁹

Great starting power for cars, sport-utility vehicles, pick-up or light trucks, RVs, and farm and ranch equipment. Units include heavy-duty cases, clamps and cable construction. Built to work with high-output AGM batteries and internal smart chargers. Select models feature an On/Off switch for added safety and an integrated voltmeter for battery/system testing.

Lithium Power

JUMP STARTER + FUEL PACK + BACK-UP POWER

SKU 674858
SL1 **149⁹⁹**

- Scrolling Digital Display
Easy-to-read, animated display gives you step by step instructions to properly jump start your battery
- Ultralight Design
- Jump Starter - Great for power sports, motorcycles and 4-6 cylinder cars.
- 2A USB Port charges all USB devices
- Charge 12V DC devices when traveling. Protect your vehicle settings while switching out your battery. (Memory Saver not included.)
- Lithium Iron Phosphate Battery provides longer life, 5x more cycle life and 4x-5x more cranks than lead-acid battery jumpers.
- Safe Lithium Ion Protection. Spark-free. Built-in safety protection design to prevent overcurrent, short-circuit, overload, overvoltage and overcharge.



JUMP STARTER

SKU 348162
SL65 **109⁹⁹**

LCD Display with On/Off Button
Easy-to-read, display shows battery capacity and input/output

- Compact Design/Travel Bag
This durable case has a soft-touch finish, portable compact design that will conveniently fit in your travel bag, backpack or glove box
- Jump Starter - Quickly starts vehicles in emergencies. Great for power sports, motorcycles and 4-6 cylinder cars.
- 2.1A/1A USB Ports for 2X faster charging.
- Charge all USB devices, including smartphones, mp3 players and tablets.
- Smart Cable provides protection against: reverse polarity, short circuit, low voltage, high temperature and reverse charging.
- Built-In LED Light (3-Modes)



Batteryless Jumpstarters

DSR PROBOOSTER
POWERED BY SCHUMACHER

These Batteryless Jumpstarters are HD professional grade. The light-weight and Compact Design is user friendly, both for the professional and occasional customer. UltraCaps can be used up to 10,000 times without performance loss offering greater value and longer service. UltraCaps need only 2 mins or less for a complete charge.



Batteryless Jumpstarter

SKU 592157
DSR108 **229⁹⁹**

- 450 CCA
- 100 sec quick charge
- 10,000+ Starts / 10 Year Shelf Life
- Jumpstart Gasoline and Diesel Engines
- Built-in Voltmeter
- Short Circuit Protection
- Reverse Polarity Protection



Batteryless Jumpstarter

SKU 592158
DSR109 **289⁹⁹**

- 800 CCA
- 120 sec quick charge
- 10,000+ Starts / 10 Year Shelf Life
- Jumpstart Gasoline and Diesel Engines
- Built-in Voltmeter
- Short Circuit Protection
- Reverse Polarity Protection



Contact Us:
1-877-AZTool1 Phone
 (1-877-298-6651) *Hablamos Español*

WHEN YOU NEED TO GET INTO A
 TIGHT PLACE WITH SOME MUSCLE
TORQUE IT WITH

**INNOVATION AND
 ERGONOMICS
 IN A TIGHT PACKAGE**

- Twin Hammer Mechanism
- One Handed Operation
- Forward and Reverse

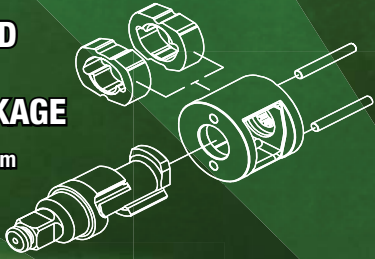

450 Ft./Lbs.
 Reverse Torque



320 Ft./Lbs.
 Reverse Torque

FRONT-BACK LENGTH
5 1/4"

LIGHT WEIGHT
3.5
 LBS.

FREE SPEED
11000
 RPM

**MIGHTY COMPACT
 1/2" IMPACT WRENCH**

SKU 626146 24403

119⁹⁹

REG. \$149.99

**SAVE
 \$30**

119⁹⁹

REG. \$149.99

**SAVE
 \$30**

**MIGHTY COMPACT
 3/8" IMPACT WRENCH**

SKU 802213 24411

SEE DETAILS, PAGE 72 >>>

Offer Good Through June 30, 2017 - While Supplies Last

Booster Cable
 2 Gauge 20' 600P Clamp
 SKU **741369** **149⁹⁹**
 00186

- Made in USA
- Cables are made of 2 gauge 100% copper conductors
- Color-coded, tangle-free dual cable construction
- Specifically designed for maximum flexibility and easy handling



Booster Cable
 4 Gauge 20' 500G Clamp
 SKU **741367** **99⁹⁹**
 00159

- Made in USA
- Cables are made of 4 gauge 100% copper conductors
- Color-coded, tangle-free dual cable construction
- Specifically designed for maximum flexibility and easy handling
- Patented clamp and jaw designed for 3 jump starting applications: top post, side terminal, and remote battery access terminal



Plug In Booster Cable
 2 Gauge 30' 600E Clamp
 SKU **747186** **199⁹⁹**
 04665

- Made in USA
- Cables are made of 100% copper conductors
- Color-coded, tangle-free dual cable construction
- Consists of 5' battery connector cable with plug connector and 25' cable with clamps



Plug In Booster Cable
 4 Gauge 20' 500G Clamp
 SKU **747189** **139⁹⁹**
 03667

- Made in USA
- Cables are made of 100% copper conductors
- Color-coded, tangle-free dual cable construction
- Consists of 5' battery connector cable with plug connector and 15' cable with clamps
- Patented clamp and jaw designed for 3 jump starting applications: top post, side terminal, and remote battery access terminal



Commercial Battery Cable Splice -
 2/0 Gauge With Overmold
 SKU **741392** **36⁹⁹**
 04963

- Replaces worn out battery cable terminal end
- Extends battery cable length
- Fits up to 3/8" stud
- Fits positive and negative studs
- Includes hex wrench
- Dual set screws for secure connection



Commercial Battery Cable Splice -
 2/0 Gauge With Tin Plated Lug
 SKU **741385** **27⁹⁹**
 04958

- Replaces worn out battery cable terminal end
- Extends battery cable length
- Fits up to 3/8" stud
- Fits positive and negative studs
- Includes hex wrench
- Dual set screws for secure connection



Commercial Battery Cable Splice -
 2/0 Gauge With Brass Top Post Terminal
 SKU **741370** **27⁹⁹**
 04957

- Replaces worn out battery cable terminal end
- Extends battery cable length
- Fits positive and negative posts
- Includes hex wrench
- Dual set screws for secure connection



Power Sports Booster Cable
 10 Gauge 10' 50A Clamp
 SKU **460709** **14⁹⁹**
 00146

- Used For Small Engine/Motorcycle/ATV/ Watercraft Service
- Tough PVC insulation
- Tangle-free dual cable construction
- Storage bag included



Group 31 Multi-Battery
 Overmolded
 Cable Assembly

- Made with 2/0 PVC starter cable
- Attached protective caps to seal connection
- Fits up to 3/8" stud



2-Battery, Red, 7"
 SKU **741376** **24⁹⁹**
 04362

2-Battery, Blk, 7"
 SKU **741382** **24⁹⁹**
 04363

3-Battery, Red, 14"
 SKU **741368** **38⁹⁹**
 04364

3-Battery, Blk, 14"
 SKU **741387** **38⁹⁹**
 04365

4-Battery, Red, 21"
 SKU **741393** **54⁹⁹**
 04662

4-Battery, Blk, 21"
 SKU **741388** **54⁹⁹**
 04663

Group 31
 Closed Top Nuts,
 Bag of 25
 SKU **741381** **59⁹⁹**
 05419

- 3/8" - 16 unc thread and 9/16" hex head
- Stainless steel sintered material
- Fits Group 31 overmolded cable assemblies



Protective
 Stud Caps,
 Black, Bag of 10
 SKU **741379** **12⁹⁹**
 04892

- Fits 3/8" Stud
- Helps protect against corrosion
- Fits Group 31 overmolded cable assemblies



Power Sports
 Charging Post,
 Bag of 25
 SKU **741380** **39⁹⁹**
 00385

- Facilitates charging and testing of power sports batteries
- Posts have M6 threaded stud to screw into power sports battery terminals
- Fast finger tight installation



Protective
 Stud Caps,
 Red, Bag of 10
 SKU **741378** **12⁹⁹**
 04893

- Fits 3/8" Stud
- Helps protect against corrosion
- Fits Group 31 Overmolded Cable Assemblies



ENGINE SERVICE TOOLS

Freeze Plug Kit

Master Freeze Plug Tool Kit

SKU 965837
27208 **99⁹⁹**

- Designed to Remove and Install Freeze Plugs Used in Liquid-Cooled Gas and Diesel Engines



OEM TOOLS

Throttle Depressors

Brake - Accelerator Pedal Depressor

SKU 802194
24232 **29⁹⁹**

- Easy to Adjust
- Extends to 24"
- Suitable for Many Diagnostic Applications



OEM TOOLS

Throttle Pedal Depressor

SKU 222525
LIS48700 **31⁹⁹**

- Holds Throttle at a Constant RPM
- Length: 40"



Belt Tools

Stretch Belt Mate Kit

SKU 544729
24388 **12⁹⁹**

- Easily Installs All Stretch Fit Belts

[Scan for Instructions on How to Use Stretch Belt Mate Kit](#)



OEM TOOLS



Serpentine Belt Tool

SKU 013620
24687 **19⁹⁹**

- Provides Leverage and Clearance to Release the Spring Pressure and Remove the Tensioner Pulley
- Includes 4 Shallow Sockets, Sizes: 13, 15, 16 and 18 mm; and 1/2" and 3/8" Square Drive Adapters



OEM TOOLS

STORE STOCK

Stretch Belt Installation Tool

SKU 227301
24363 **21⁹⁹**

- Works on Both Large and Small Pulleys
- Clamping Jaw Allows User to Position Serpentine Belt without the Belt Slipping Out of the Tool

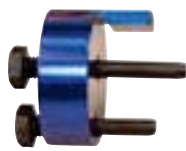

OEM TOOLS

Stretch Belt Remover and Installer

SKU 255866
LIS59370 **22⁹⁹**

- Unique Magnetic Faces Hold the Tool in Place on the Pulley
- Compact, One-Piece Tool Can Be Used on the Front or Back Side of the Pulley



Serpentine Belt Tool

SKU 695121
33627115 **30⁹⁹**

- Provides Required Leverage and Clearance to Release Spring Pressure and Remove Tensioner Pulley



OEM TOOLS

Block Testers

Block Tester

SKU 695104
33627145 **25⁹⁹**

- Locate Internal Combustion Leaks Quickly and Easily
- When Fluid Turns from Blue to Yellow a Combustion Leak is Present



OEM TOOLS

Block Tester Test Fluid (8 Oz.)

SKU 391381
25739 **8⁹⁹**

- Use with Block Tester #33627145



OEM TOOLS

Engine Cylinder Hones

Adjustable Engine Cylinder Hone Deglazer

SKU 532002
25041 **31⁹⁹**

- Range: 2" to 7" (51 mm to 128 mm)
- Spring Tension Adjusting Nut for Positive Cutting Action at All Speeds
- Supplied with 4" Medium Grit Stones

Replacement Stone Sets

- | | | |
|--|--|---|
| SKU 141540
2541C
11⁹⁹
STORE STOCK
• 3 Coarse Grit (#220) | SKU 532036
2541M
11⁹⁹
STORE STOCK
• 3 Medium Grit (#220) | SKU 532044
2541F
9⁹⁹
STORE STOCK
• 3 Fine Grit (#400) |
|--|--|---|



OEM TOOLS



BRM

Flex-Hone™ BC

10 mm (.394") SKU 341249 BRMBC10M18 24⁹⁹	6.4 mm (.250") SKU 343384 BRMBC64M24 24⁹⁹
---	--



BRM

Flex-Hone™ GB

3-1/2" (89 mm) SKU 341239 BRMGB31212 47⁹⁹	3-1/4" (83 mm) SKU 341232 BRMGB31412 47⁹⁹
--	--

3-3/4" (95 mm) SKU 341317 BRMGB33412 53⁹⁹	4-1/8" (105 mm) SKU 341325 BRMGB41812 57⁹⁹	4-5/8" (118 mm) SKU 341332 BRMGB45812 63⁹⁹
--	---	---

CALL FOR ADDITIONAL SIZES

Torque Adapter

Offer Good Through June 30, 2017 - While Supplies Last

OEM TOOLS

Torque Adapter, Diesel Head Bolt, Ford 6.0L Power Stroke® Engines

SKU 298191
24208 **24⁹⁹** REG. \$34.99

SAVE \$10



- Eliminates the Need to Remove the Truck/Van Cab from the Chassis to Access the Rear Head Bolts
- Eliminates the Need to Remove the Evaporator Housing, Saving 2 Hours of Time and the Additional Cost of Refrigerant Added During A/C Recharging
- Prevents Damage to the Rear Heat Shield
- Use with OEM 27309 3/4" Drive Torque Wrench and OEM 22398 18mm Socket

DID YOU KNOW?

AutoZone® carries a full line of Fel-Pro gaskets.

Contact Your AutoZone Commercial Sales Manager for Details

Fan Clutch Tools

OEM TOOLS

Universal Pulley and Fan Clutch Holder

SKU 547013
27281 **69⁹⁹**

- Fits Many Different Fan Clutches, Cam and Crank Pulleys with Slots or Holes
- Pin Sizes: 6 - 10 mm, 8 - 11 mm, 10 - 12 mm, 11 - 16 mm
- Adjustable Diameter: 1-1/2" - 8-5/8"



Universal Fan Wrench Set

SKU 080554
LIS43600 **73⁹⁹**

- Use on the Most Popular Applications
- Hooked Wrench Design Holds 2 Nuts or Bolts, Allowing the Technician to Tighten/Loosen the Other 2
- Double-Sided Spanner Style Holding Wrench Will Hold Pressed on Pulleys on Many GM, Jeep and Dodge Vehicles

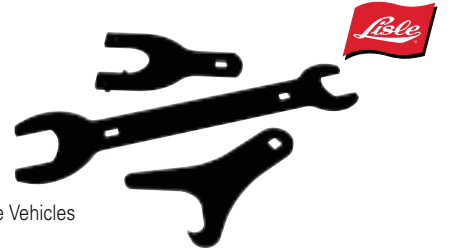

Fan Clutch Wrench Set

SKU 110280
27186 **79⁹⁹**

- Combines OEM #27108 and OEM #27141 into a Master Set
- Ideal for Removing Fan Clutches from Water Pumps
- Set Includes: 36, 40, 48, 54, 57, 68, 72, 76 and 83 mm Wrench Sizes

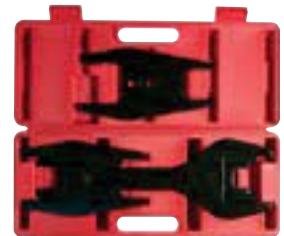

OEM TOOLS

Pneumatic Fan Clutch Wrench Set

SKU 291409
LIS43300 **182⁹⁹**

- Quickly Removes and Installs Fan Clutch When Repairing the Water Pump or Fan Clutch
- Set Includes Wrench Sizes: 32, 36, 40 mm; 7/8", 1-7/8" and 2"



Fan Clutch Service Set for Mercedes-Benz and BMW

SKU 512958
27224 **199⁹⁹**

- Removes Lock Nuts on Thermo Viscous Fans Found on Mercedes-Benz, BMW and Many Ford Models
- Includes: (1) Mercedes-Benz Fan Clutch Wrench - 36mm, 40mm and 65 mm Opening (1) BMW Fan Clutch Wrench - 32 mm Opening (1) BMW Fan Clutch Holding Wrench - 38 mm and 44.5 mm and 1 Mercedes-Benz Fan Clutch Holding Tool



OEM TOOLS

Clutch Tools

Flywheel Turner

SKU 505066
LIS23800 **34⁹⁹**

- For Turning and Holding Flexplates and Flywheels
- Easily Turn Engine from Underneath the Vehicle



Duramax Flywheel Lock

SKU 301613
LIS22100 **49⁹⁹**

- Locks Flywheel in Place When Removing Harmonic Balancer on 6.6L Duramax with Allison Transmissions
- Saves Time By Locking the Flywheel at the Transmission Instead of Having to Remove the Starter for Water Pump Replacement





Contact Us:
1-877-AZTool1 Phone
 (1-877-298-6651) *Hablamos Español*

OEM TOOLS®

Ford Cam Phaser Noise Repair Kit 4.6/5.4 3V

Adding This Kit to a 4.6/5.4L 3V Car, Truck, or SUV Will Help Ensure That Your Cam Phasers Don't Suffer Premature Failure

This Kit is a True, Long Term Repair for Ford Cam Phaser Noise.

SKU 079897
24206 **649⁹⁹** REG. \$699.99 **SAVE \$50**

- Included Timing Chain Wedge Tool Increases Ease of Installation
- Included Simple to Use Vehicle Computer Programmer with OBD-II Cable to Disable Cam Phaser Function
- One Kit Corrects Both Cam Phasers
- Cam Phaser is NOT INCLUDED

Offer Good Through June 30, 2017 - While Supplies Last

Ford Timing Chain Locking Wedge Tool (4.6/5.4 3V Engines)

SKU 012647
24207 **19⁹⁹**

- For 2005-14 5.4L and 4.6L 3V
- OE Type Tool
- Allows for Easy Cam Changes without Removing the Timing Cover



24206 SHOWN

NEW

Max Energy Tuning Optimizes Spark and Air/Fuel Ratio from Just Off Idle to Wide-Open Throttle. Maximum Horsepower and Torque Gains Are Provided to Work Perfectly with the Cam Phaser Kit.

Ford Cam Phaser Noise Kit 4.6/5.4 3V with Tuning

SKU 597001
24209 **799⁹⁹**

- Includes Performance Tuning Optimized for this Kit to Produce Max Horsepower and Torque
- This Kit Also Includes Tuning Options for Airflow, TPMS, Top Speed Limit, Speed of Calibration, Rev Limiter, Shift Firmness, Shift Point, Cooling Fan On/Off Temp
- Note: Not all Features are Available in All Applications the Year, Make, & Model Of the Vehicle Will Determine the Feature Set for That Application.
- Cam Phaser is NOT INCLUDED

Valve Train Tools

Valve Spring Compressor

SKU 231210
25220 **19⁹⁹**

- Designed for Use on Most Trucks and Cars with Overhead Valves



Push Rod Remover

SKU 459100
LIS48300 **24⁹⁹**

- Redesigned for Newer 3.5L and 3.6L GM Engines - Also Works on GM V6 2.8L, 3.1L and 3.4L
- Quickly Removes Push Rods to Replace the Intake Gaskets without Removing Rocker Arms



Timing Gear Holder

SKU 544797
24387 **39⁹⁹**

- Holds the Timing Gear in Place During Removal and Installation and Prevents it from Moving While the Retaining Bolt is Removed
- Allows the Cam Gear to Rotate to Align Valve Timing Marks
- Single Lever Locking Design is Easy-to-Use



Valve Keeper Remover and Installer Kit

SKU 011658
LIS36050 **69⁹⁹**

- For Use with Valve Stems from 4.5 to 7.5mm and 5/16" to 3/8"
- Magnet in Tool Body Captures Keepers
- Works on Toyota 4 Cylinder and Chrysler New World Engine Applications



Makes valve component disassembly and reassembly fast and easy

Ford Valve Spring Compressor

SKU 626111
24434 **54⁹⁹** REG. \$69.99

- Applications: 1991-2004 Ford Vehicles with 4.6L, 2V, V8 Engines; 4.6 4V, 5.4 V8 and 6.8 V10
- Works with Engine Removed or Installed, Cylinder Head On or Off
- Not for Triton 5.4 3V

SAVE \$15



Parallel Lift Spring Compressor

SKU 516515
27075 **69⁹⁹**

- Strong But Light Frame - Weighs Only 6 Lbs.
- Works with Most Valve-in Head and L-Head Engines as Well as Truck and Tractor Engines
- Spring Capacity: 1" - 2"
- Throat Depth: 10"
- Includes Straight and Offset Jaws



Piston Tools

Piston Ring Compressor

SKU 013641
24682 **14⁹⁹**

- 1-1/2" Deep, Low-Friction Wrinkle Band
- Fits 3" to 5" Pistons



STORE STOCK

Ridge Reamer

SKU 532325
25051 **24⁹⁹** REG. \$31.99

- Capacity: 3" to 5" (76 mm to 127 mm)
- For Use on Conventional and Slant-Block Engines

SAVE \$7



Offer Good Through June 30, 2017 - While Supplies Last

DID YOU KNOW?

AutoZone® has availability on Moog HUB Bearings.

Contact Your AutoZone Commercial Sales Manager for Details

Cam/Crankshaft Tools

Ford 2.0L, 2.3L, 2.5L Cam Tool Kit

SKU 626108
24448 **24⁹⁹**

- Applications: 2.0L DOHC Engines Found in 1994-2003 Ford and Mercury, 2004-2012 2.5L DOHC, 2.3L DOHC 4V and 2.0L DOHC Engines in Ford, Mercury and Mazda, and 2.0L DOHC Engines in 1993-1994 Ford Probe



Honda Crankshaft Pulley Holding Tool

SKU 217379
27176 **29⁹⁹** REG. \$39.99 **SAVE \$10**

- Holds Crankshaft Dampeners When Tightening/Loosening Crankshaft Bolts on Honda and Acura Engines 1990 to Present



Offer Good Through June 30, 2017 - While Supplies Last

17 mm Crank Bolt Socket

SKU 818785
CAL981 **29⁹⁹**

19 mm Crank Bolt Socket

SKU 818784
CAL982 **29⁹⁹**

21 mm Crank Bolt Socket

SKU 818782
CAL983 **29⁹⁹**

- Remove Stubborn Crankshaft Pulley Bolts
- Increase Working Torque Up to 50%
- Works with Any Standard 1/2" Impact

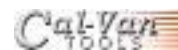

No Special Tool Required

DOHC Cam Lock Holder

SKU 291419
LIS36880 **39⁹⁹**

- This Versatile Tool Easily Locks and Holds Both Camshaft Sprockets Firmly in Place
- Preserves the Engine Timing During Belt or Chain Replacement

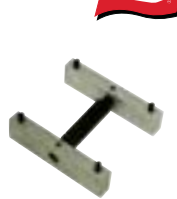

Universal Cam Adjuster

SKU 22524
LIS38220 **39⁹⁹**

- Adjusts to Fit Different Size Cam Sprockets
- Holds Cam Sprocket in Place When Removing Cam Bolt
- Works on All Single and Dual Overhead Cam Sprockets with Holes



2 Piece Cam Clamp™ Set

SKU 238159
24360 **24⁹⁹**

- Specifically Designed to Retain Sprocket Wheels While Maintaining Proper Timing During Belt Service
- Simple to Use
- Installs in Seconds



5 Piece Master Cam Clamp Kit

SKU 383452
27210 **69⁹⁹** REG. \$79.99 **SAVE \$10**

- Covers Most Single, Twin Cam and Quad Cam Engines
- Locks Camshaft to Hold Valve Timing During Timing Belt Replacement

Offer Good Through June 30, 2017 - While Supplies Last



Camshaft and Crankshaft Seal Tool Kit

SKU 544799
24386 **99⁹⁹**

- Easily Removes and Installs Camshaft and Crankshaft Seals
- Compact Puller with Unique Extracting Hooks Engage Seal for Quick Removal
- Interchangeable Sleeves and Mandrels Allow Easy Installation of New Seal
- Suits Seals from 21.5 mm - 64 mm
- Sleeves and Mandrels Made from High Strength Fiber Glass Reinforced Polymer



QR Code



Scan for Instructions on How to Use This Universal Seal Tool Kit

Crankshaft and Camshaft Seal Kit

SKU 512952
27222 **129⁹⁹** REG. \$149.99 **SAVE \$20**

- Install and Remove Oil Seals Between 27mm and 58mm in Diameter

SAVE \$20

Offer Good Through June 30, 2017 While Supplies Last



Universal Camshaft Bearing Tool

SKU 191677
27143 **229⁹⁹**

- Removes or Inserts Camshaft Bearings in Nearly All Engines
- Easy on Bearings
- Range: 1.125" to 2.69"
- Set Includes: Driving Shaft, Driving Shaft Extension, Expander Unit, (5) Split Driving Plugs, (2) Driving Collars and Centering Cone



CHASSIS/SUSPENSION

Tie Rod Tools

OEM TOOLS



Master Inner Tie Rod Tool Set

SKU 344979 27178 **99⁹⁹**

Works on Both Small Cars and SUVs

- Tube Handle Has an Inner Diameter of 2.125" to Service Small Cars, Pick Ups and Large SUVs
- Includes 12 Crowfoot Style Adapters, Sizes: 29mm, 1-3/16", 1-1/4", 32.5mm, 1-5/16", 33.6mm, 1-3/8", 1-7/16", 1-1/2", 38.4mm, 40mm and 42mm
- Comes in a Blow Mold Case

Inner Tie Rod Tool

SKU 094645 25296 **19⁹⁹**

STORE STOCK

- Used to Easily Turn Tie Rods
- Use with an Extension, Tighten Nuts on U-Bolt as Needed
- Tool Can Remove Inner Tie Rod without Removing the Outer Tie Rod



Inner Tie Rod Tool Kit

SKU 217377 27185 **49⁹⁹** REG. \$59.99

SAVE \$10

- Removes and Installs Tie Rod End on Rack and Pinion Steering
- Includes: 1-3/16", 1-5/16" and 1-7/16"



Offer Good Through June 30, 2017 - While Supplies Last

Tie Rod End Remover

SKU 695086 33627175 **40⁹⁹**

- Used on Imports and Many Front Wheel Drive Vehicles and Rack and Pinion Steering
- Pressure Screw Tip Swivels for Damage Free Results and Will Not Damage Tie Rod End Dust Boots



Inner Tie Rod Tool

SKU 291414 LIS45750 **89⁹⁹**

- Utilizes Six Sizes: 1-3/16", 1-1/4", 1-5/16", 1-7/16", 1-1/2" and 33.6 mm
- Long Socket Slips Over Tie Rod End and Connects to the Crowfoot
- Includes 1-1/2" Crowfoot for Use on Chevrolet Colorado and GMC Canyon

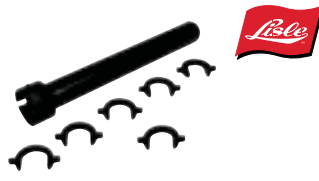

Master Inner Tie Rod Tool

SKU 080557 LIS46800 **148⁹⁹**

- Works on Inner Tie Rods with Inaccessible Wrench Flats
- Includes 9 Crowfoot Style Adapters to Work on Various Applications
- Long Socket Slips Over the Tie Rod End and the Crowfoot Engages on the Socket for Easy Removal and Installation



Hub Bearing

OEM TOOLS

23 Piece Hub Bearing Remover and Installer Kit

SKU 094804 27205 **199⁹⁹**

- Removes and Installs Wheel Bearings with Steering Knuckle and Strut Assembly Still on the Vehicle, Eliminates Need for Alignment



Master Wheel Hub and Bearing Remover and Installer Kit

SKU 298230 27213 **399⁹⁹** REG. \$449.99

- For Removal and Installation of Front Wheel Hub and Bearings on Asian, Domestic and German Vehicles Along with Rear Wheel Hubs and Bearings on European Vehicles
- Works on Front, Rear and All-Wheel Drive Vehicles
- Self Centering Design is Incredibly Durable and Easy to Use
- Broader Application with Fewer Components Than Many Other Tools



SAVE \$50

Offer Good Through June 30, 2017 While Supplies Last

Seal Tools

OEM TOOLS

Seal Puller

SKU 048199 25014 **12⁹⁹**

STORE STOCK

- Two Tips Fit All Seal Sizes

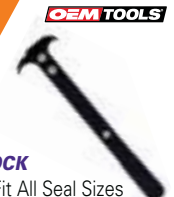

Bearing Race and Seal Driver Set

SKU 695119 33627119 **60⁹⁹**

- Used to Install Most Standard Wheel Bearing Races and Seals



Pinion Shaft Seal Driver

SKU 080559 LIS56950 **89⁹⁹**

- Used for Driving Pinion and Other Seals Into Place
- Hollow Adapter Allows Driver to Slide Over Shaft to Drive Seal



Transmission/Transaxle Plugs

SKU 298196 24490 **19⁹⁹**

- Includes Five Plugs to Seal Both Transmissions and Transaxles on Most Import and Domestic Vehicles
- Stepped Design for Retention and Positive Sealing
- Includes Side Gear Centering Pin for Ford Transaxles



Universal Seal Installer Kit

SKU 818737 25082 **34⁹⁹** REG. \$39.99

- Knurled Handles
- Includes: 3" Driver, 2.5" Driver, Short Handle, Long Handle, Spider Insert, 5/16" x 1" Cap Screw, Large Spider, Small Spider and Washer
- Long Handle Provides Good Flexibility When Installing Pinion Seals
- Comes in a Sturdy Blow Mold Case

SAVE \$5



Offer Good Through June 30, 2017 While Supplies Last

Spring Compressors

Universal Strut Remover

SKU 141509 25423 **29⁹⁹**

- Removes the Top Nut on Many MacPherson Struts
- Deep Socket is Used to Remove Nut
- Includes: 3/4" Adapter, 6.5 mm Hex, "Double D" and 7.5 mm Hex and "Double D" Sockets
- Comes with T-50 Star, 10 mm Internal Hex and "Double D" Sockets



MacPherson Strut Spring Compressor

SKU 070135 25550 **34⁹⁹**

STORE STOCK

- Used to Compress Strut Spring During Cartridge Replacement
- Forged Hook
- Heat-Treated Forcing Screw
- Safety Latches



Coil Spring Compressor

SKU 695608 33627035 **50⁹⁹**

- Used to Compress the Coil Spring in the Installation of Coil Spring Spacers
- Comes in a Sturdy Blow Mold Case



Strut/Coil Spring Compressor Kit

SKU 094802 27203 **74⁹⁹** REG. \$79.99

SAVE \$5

- Used to Compress Most Sizes of MacPherson Springs and Coil Springs
- 10 Piece Kit
- Heat-Treated for Toughness
- Comes in a Blow Mold Case



Offer Good Through June 30, 2017 - While Supplies Last

Model 7600 Strut Spring Compressor

SKU 547959 BRA7600 **899⁹⁹**

- Handles the Toughest Applications
- Min/Max. Spring Diameters: 3.5" / 11.5"
- Made in the USA



Cart for BRA7600

SKU 547960 BRA00-0137 **389⁹⁹**

Bench Mount for BRA7600

SKU 547962 BRA00-0125 **54⁹⁹**

StrutTamer™ II Extreme with Stand

SKU 471100 OTC6637-ST **899⁹⁹**

- Meets the New ASME PASE Standards for Spring Compressors
- Capable of Safely Compressing the Largest Strut Springs
- New Forged Locking Jaws Include Larger Pads and Offset to Clamp Onto and Compress Springs Even Tighter Than Before
- Unique Trunnion Locking Mechanism to Eliminate Arm Movement for Stable Compression



Suspension

OEM TOOLS

GM Upper Control Arm Knock Out Tool

SKU 420336 24210 **19⁹⁹**

- Services 1989-2001 Chevrolet and GMC 1/2, 3/4 and 1 Ton, 2 and 4 Wheel Drive Trucks and 1990-2002 All Wheel Drive Chevrolet Astro and GMC Safari Vans



Universal Steering Knuckle Spreader Tool

SKU 512957 27234 **89⁹⁹**

- Used to Spread Lower Ball Joint, Preventing Costly Damage to Knuckle



Camber Adjustment Tool

SKU 360484 DOWTC614 **254⁹⁹**

- Makes Camber Adjustment a "One-Man Job"
- Inflatable Air Bladder Fits Between Tire and Strut for Easy and Controlled Adjustment of Camber Settings
- Camber Can Be Set with Wheels on Ground
- Eliminates the Need for Special Camber Bolts



CV Axle Nut Sockets

OEM TOOLS

6 Point Axle Nut Socket Set

SKU 900822 27188 **84⁹⁹**

- Includes Sizes: 27, 29, 30, 32, 34, 35, 36, 38 and 39 mm
- Chrome Moly Sockets are Impact Rated
- Black Oxide Finish to Resist Rust
- Comes in a Blow Mold Case



1/2" Drive Axle Nut Sockets

30 mm SKU 079988 | 25203 **14⁹⁹**
 32 mm SKU 552315 | 25204 **14⁹⁹**
 33 mm SKU 864643 | 25152 **14⁹⁹**
 34 mm SKU 010252 | 25205 **14⁹⁹**
 35 mm SKU 864642 | 25153 **18⁹⁹**
 36 mm SKU 079772 | 25206 **19⁹⁹**

- Removes and Installs the Front Drive Hub/Axle Nuts on 4-Wheel Drive and Many Front Wheel Drive Automobiles
- For Use with a 1/2" Drive Ratchet
- 1/2" Drive Chamfered Square Drive



12 Point Axle Nut Socket Set

SKU 751696 24480 **89⁹⁹**

- Includes Sizes: 29, 30, 32, 34, 35, 36, 38 and 39 mm
- Chrome Vanadium Sockets are Impact Rated
- Black Oxide Finish to Resist Rust
- Comes in a Blow Mold Case



12 PT Axle Nut Socket 1/2" Drive

20⁹⁹
 29 mm SKU 821446 | 33627322
 30 mm SKU 191051 | 25157
 31 mm SKU 821448 | 33627324
 32 mm SKU 821449 | 33627325
 33 mm SKU 821451 | 33627326
 34 mm SKU 821453 | 33627327
 35 mm SKU 821455 | 33627328
 36 mm SKU 821456 | 33627329
 38 mm SKU 821457 | 33627330
 39 mm SKU 821452 | 33627331

Shock Tools

OEM TOOLS

Volvo Shock Retaining Nut Strut Removal Socket Tool

SKU 300125 24365 **24⁹⁹**

- Includes Holding Socket with "Double D" Axle Center Socket
- Fits Several Volvo Models 1999-2010



Universal Shock Absorber Tool

SKU 036202 25038 **16⁹⁹**

- For Removing and Installing Shock Nuts
- Fits Many Shock Stems



Unloading Tool

OEM TOOLS

GM Torsion Bar Unloading Tool

SKU 099289 27235 **99⁹⁹**

- Built for GM's K-3500 Series Trucks with the Heavy Duty Chassis
- Also Works on 1988-2003 GMC and Chevrolet 1/2, 3/4 and 1 Ton Pick-Ups; S-10 Blazers, S-15 Jimmys, 4WD Pick-Ups with 4.3L V-6 Engines and 1991 to 2001 Oldsmobile Bravada



Pitman Arm Pullers

OEM TOOLS

Pitman Arm and Ball Joint Front End Service Kit

SKU 900820 27181 **99⁹⁹**

- Services Pitman Arm, Tie Rod and Ball Joints
- Includes: Pitman Arm/Tie Rod End Puller, Ball Joint Separator, Pitman Arm Puller, Ball Joint/Tie Rod End Remover
- Comes in a Sturdy Blow Mold Case





Contact Us:
1-877-AZTool1 Phone
 (1-877-298-6651) *Hablamos Español*

Pickle Fork

OEM TOOLS

Tie Rod End Puller

SKU 004463 25201 **11⁹⁹**

STORE STOCK

- Tapered Fork Wedged Ends with 21/32" Opening
- Overall Length: 11-7/8"



Ball Joint Separator

SKU 004464 25202 **11⁹⁹**

STORE STOCK

- Tapered Fork Wedged Ends with 15/16" Opening



3 Piece Pickle Fork Set

SKU 802196 27080 **27⁹⁹** REG. \$34.99

- Can Be Used for Tie Rod End, Pitman Arm and Ball Joint Removal

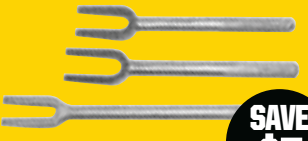

Offer Good Through June 30, 2017 While Supplies Last

SAVE \$7

5 Piece Pickle Fork Set

SKU 466511 25261 **35⁹⁹**

- Set Includes: Tie Rod Spreader with 11/16" Wedge Opening, Ball Joint Separator with 15/16" Jaw Opening, Pitman Arm Wedge with 1-1/8" Opening, 8" Handle



Stepped Pickle Fork Set

SKU 291410 LIS41400 **59⁹⁹**

- 6 Tools in One
- Includes: 11/16", 15/16", 1-1/8"
- Forks and 2 Handles



5 Piece Tie Rod and Ball Joint Set

SKU 094799 27201 **69⁹⁹**

- Used to Remove Tie Rods and Ball Joints
- Includes: 11" x 1-1/8", 11-5/8" x 1-7/16", 11-3/4" x 1-5/8", 16" x 11/16" and 16" x 15/16"



Spindle Nut

OEM TOOLS

1/2" Drive Socket Bearing Locknut

SKU 231203 25243 **14⁹⁹**

STORE STOCK

- Fits Adjusting Nuts Found on 1995-96 Ford F150 Trucks and Full-Sized Broncos with Automatic Locking Hubs



4WD 4 Lug Spindle Socket

SKU 552265 25072 **19⁹⁹**

STORE STOCK

4WD 6 Lug Spindle Socket

SKU 695598 33627046 **20⁹⁹**



1/2" Drive Wheel Bearing Locknut Socket Kit

SKU 295858 WLMW89314 **49⁹⁹**

- Specially Designed to Easily Remove or Install 6-Point Wheel Bearing Locknuts
- Contains: 2-3/8", 2-1/2" and 55 mm Locknut Sockets; and 2-3/8", 2-1/2", 2-9/16", and 2-3/4" Rounded Locknut Sockets



While Supplies Last

Spindle Locknut Wrench Kit

SKU 695087 33627174 **110⁹⁹**

- Ideal for 4 Wheel Drive Axle Retainers
- Use with Many 1/2 Ton Vehicles with Dana 44 Series Axles and with Many 3/4 Ton Vehicles with Dana 70 Series Axles.



GM Axle Hub Nut Socket

SKU 298219 25967 **24⁹⁹** REG. \$29.99

- Applications: GMT900 Silverado, Sierra HDCS, 2-Wheel and 4-Wheel Drive Cheyenne, Silverado, Escalade, Sierra and Avalanche Trucks with 10.5" or 11.5" Ring Gear
- Has 9 Pins to Fit GM New Style Retaining Nuts
- Unapproved Methods Can Damage the Bearing, or Result in Shorter Service Life



SAVE \$5

Offer Good Through June 30, 2017 - While Supplies Last

Toyota 4-Pin Hub Locknut Socket

SKU 298224 25969 **19⁹⁹**

- Services High-Torque Locknuts on Toyota 4WD Vehicles Having Free-Wheel (Lock Out) Hubs
- 1995-Newer Tacoma; 1996-Newer T100 and 4Runner
- Improved Design with Solid Pins for Increased Durability



Toyota 8-Pin Front Hub Locknut Socket

SKU 298205 25962 **39⁹⁹**

- Allows for Easy Removal and Installation of Front Hub Lock Nut without Damage to the Nut
- Applications 2007 - 2014 Toyota 4Runner 2WD, 2008 - 2014 Toyota Sequoia, 2007 - 2014 Toyota Tundra
- 3/4" Drive



Dodge Hub Locknut Socket

SKU 344964 25968 **19⁹⁹** REG. \$24.99

- Fits 1994 and Newer Dodge 1/2-Ton Pickup Trucks with Dana 44 Front Axle and Dana 60 Axle with a Vacuum Disconnect
- Designed to Accommodate the 1-11/16" (43mm) Wheel Bearing Retaining Nut Which is Recessed Into the Hub



SAVE \$5

Offer Good Through June 30, 2017 - While Supplies Last

Ball Joint

OEM TOOLS

3/4" Drive Ball Joint Impact Socket 2-9/16"

SKU 462494 24215 **24⁹⁹**

- Used on Chrysler/Dodge Mid Size Cars, Light-Trucks and Vans
- Fits 2-9/16" Ball Joints
- 3/4" Drive



Ball Joint Separator

SKU 793569 33627308 **29⁹⁹**

- Used for Separating the Ball Joint from the Spindle Support Arm on Domestic and Import FWD Vehicles
- Adjustable for Different Size Ball Joints
- Max. Opening Range: 1-1/8" and 2-1/8"
- Steel Construction with Black Oxide Pins
- Comes in a Sturdy Blow Mold Case



2 Wheel Drive Ball Joint Adapter Set

SKU 695092 27089 **85⁹⁹**

- Ford Van 2WD, Upper and Lower
- Ball Joint Adapter Set for #27023 and #33627023
- Rust Resistant Finish on All Parts



4 Wheel Drive Ball Joint Adapter Set

SKU 695093 33627165 **85⁹⁹**

- Designed for Use On 1967 - Current 4WD Vehicles with Dana 44 Axles
- Upper and Lower Ball Joint Adapter Set for 27023, 27089



Ford Ball Joint Adapter Set

SKU 695095 33627163 **89⁹⁹**

- 1996-2004 Ford Taurus and Mercury Sable
- Ball Joint Adapter Set for 27023 or 27089
- Rust Resistant Finish on All Parts



Hydraulic Ball Joint Separator

SKU 596905 GGT850 **99⁹⁹** NEW

- Quick, Easy Ball Joint Separation
- 8 Ton Hydraulic Ram
- Jaw Opening Capacity: 56mm (2.25")
- Jaw Width: 22mm (0.86")
- No More Hammering Suspension Arms



Honda Ball Joint Adapter Set

SKU 695094 33627164 **119⁹⁹**

- 1980-2000 Honda Accord, Civic, DelSol, CRX and Prelude



Ball/U-Joint Press Set

SKU 695617 33627023 **119⁹⁹**

- Removes and Replaces Ball Joints on Many Vehicles
- C-Clamp Frame Press May Also Be Used to Remove and Replace U-Joints



Master Ball Joint Installer/Remover Adapter Set

SKU 793562 33627310 **135⁹⁹**

- Expands the Capabilities of OEM #27023 Ball Joint Press
- For Working on Many GM, Ford and Chrysler 2WD and 4WD Pick-Ups, Vans and SUVs
- Includes: 8 Receiving Tubes, 2 Installing Tubes, 2 Receiving Cups, 1 Plug and 1 Remover/Installer
- Comes in a Sturdy Blow Mold Case



Ball/U-Joint Press with 4WD Adapter Set

SKU 695584 33627089 **139⁹⁹**

- 1967 to Current 1/2 to 3/4 Ton 4WD
- Dana 44 Series Front Axle Adapter Sets Available: 27163, 27164, 27165 and 27166



Axle Tools

OEM TOOLS

FWD Axle Puller Adapter

SKU 695592 33627058 **20⁹⁹**

- Used to Pull CV Drive Axles from the Transmission of Front Wheel Drive Cars
- Note: Use with OEM Slide Hammer 27033



Front Wheel Drive Hub Puller

SKU 695606 33627037 **25⁹⁹**

- Fits Most Domestic and Import Vehicles with Independent Front Wheel Suspension
- Yoke and Bolt are Threaded 5/8" x 18



Axle Puller

SKU 695612 33627032 **25⁹⁹**

- Use with OEM Slide Hammer (#27033 and #33627033) to Pull Flange Type Axle on Most Domestic Cars and Trucks with 4-1/2" or 5-1/2" Bolt Circles



4WD Spindle Puller Attachment

SKU 695583 33627104 **35⁹⁹**

- Use with OEM Slide Hammer #27033 and #33627033
- Fits Most Spindles 1-1/2", 1-5/8" and 2" on 4WD Vehicles



Bushing Tool

OEM TOOLS

Manual Bushing Installation and Removal Tool Set

SKU 298214 27212 **229⁹⁹** REG. \$249.99

- Comprehensive Kit for Fast and Effective Removal/Installation of Wheel Bearings/Suspension Bushings and Seals
- Allows the Technician to Service a Wide Range of Bushings without Removing Components from the Vehicle
- Comes with 20 Sleeves for 100's of Combinations
- External Sleeve Diameter: 44, 46, 48, 50, 52, 54, 56, 58, 60, 62, 64, 66, 68, 70, 72, 74, 76, 78, 80, 82mm

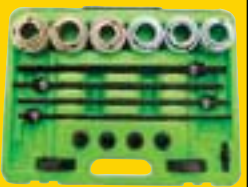

Offer Good Through June 30, 2017 - While Supplies Last

Axle Popper™ II

SKU 010119 STK71415 **39⁹⁹**

- Tapered on Both Ends
- Fits in Air Hammer
- Increased Base Size for Additional Strength
- Safer Than a Pry Bar



5 Lbs. Slide Puller

SKU 695611 33627033 **45⁹⁹**

- Threaded 5/8" x 18
- Works with OEM Attachments as Well as Other Manufacturers' Attachments with the Same Thread



Rear Axle Bearing Remover Set

SKU 695117 33627129 **55⁹⁹**

- Used to Pull Semi-Floating Rear Axle Bearings
- Use with OEM #27033 and #33627033 Slide Hammer



Rear Axle Bearing Remover Set

SKU 821450 33627305 **70⁹⁹**

- Strike the Axle Popper Wedge or Use it as a Pry Bar to Remove the Half Shaft
- Shim Included to Fill the Gap on Some Vehicles



Axle Spindle Threading Set

SKU 514007 27233 **79⁹⁹**

- Set Includes: M20 x 1.25, M20 x 1.50, M22 x 1.00, M22 x 1.50, M24 x 1.50, M24 x 2.00, 13/16" x 20 UNEF, 3/4" x 20 UNEF and 27 mm Extension Bar



Rear Axle Puller Set

SKU 094801 27202 **99⁹⁹**

- Use for Flange-Type Rear Axle and Bearing Removal on Most Late Model Passenger Cars and Light-Trucks



Impact Socket

OEM TOOLS

1/2" (12 mm) Ford Drive Line Impact Socket

SKU 420319 24212 **19⁹⁹**

- Applications Include Many Ford Drive Line Bolts
- 12 mm, 12 Point



SERVICE TOOLS

Harmonic Balancer

Harmonic Balancer Puller Retrofit Kit for GM

SKU 695100 33627296 **14⁹⁹**

- Use with OEM 33627019, 27019 and 25053 Harmonic Balancer Pullers and Many Other Popular Balancer Pullers
- The 3 Bolts Fit Through the Slotted Holes in the Balancer and Screw Into the Threads of the Balancer on GM 3300 and 3800 V6 Engines
- Shoulders on the Bolts Prevent Damage to the Crank Sensor That Can Occur When Using Standard Bolts
- Includes Spacer to Prevent Damage to Crankshaft and Threads



Harmonic Balancer/Steering Wheel Puller

SKU 532440 25053 **17⁹⁹**

- Removes Balancers, Steering Wheels, Pulleys and/or Gears with Tapped Holes
- Floating Swivel Helps Prevent Damage to Shaft End
- 4 Slots in Yoke, Use for 2 or 3 Hole Applications with 3/8"-24, 5/16"-18 and 3/8"-16 Bolt Sizes

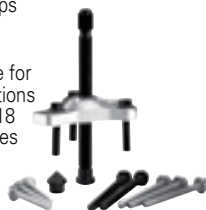

Harmonic Balancer Puller

SKU 695619 33627019 **20⁹⁹**

- Set Includes: Yoke, Pressure Screw, and Pulling Screws
- Floating Swivel Prevents Damage to Shaft Ends
- Comes in a Sturdy Blow Mold Storage Case
- Yoke Features 4 Slots
- Heat-Treated for Strength and Durability



19 mm Harmonic Balancer Socket for Honda

SKU 011632 LIS77080 **29⁹⁹**

- More Than 3X Standard Socket Mass
- For Use with 19 mm Applications
- Made with Heat-Treated Alloy Steel



Alternator

Alternator Decoupler Pulley Tool Kit

SKU 300124 27261 **24⁹⁹**

- Set Works on Both Overriding Alternator Decoupler (OAD) and One-Way Clutch (OWC) Pulleys
- Tools May Be Used While the Alternator is On or Off the Vehicle
- Comes in a Blow Mold Case



Alternator Decoupler Tool Set

SKU 255865 LIS57650 **34⁹⁹**

- Five Piece Kit for Removing and Installing Many Alternator Decoupler Pulleys on the Most Popular Vehicles in North America
- Comes in a Blow Mold Case



Harmonic Balancer Puller Kit

SKU 818738 25090 **49⁹⁹**

- Includes: Puller Body, 3 Jaw Puller, (3) Jaw Retaining Pins, (3) Wave Washers, Pressure Screw
- Insert Rods: 4", 5-13/32", 6-1/2" and 7-13/32"
- Used on Many GM, Mitsubishi and Chrysler Engines



Unique Jaw and Returning Springs for Easy Positioning of the Puller

Long Reach Harmonic Balancer Pulley Installer

SKU 544785 24442 **54⁹⁹** REG. \$59.99

- Install Crank Pulley on Many Late Model Ford, GM, Dodge and Chrysler Vehicles with V8 and V6 Engines
- Includes: M16x2.0 - GM; M14x1.5 - Dodge, Chrysler, Jeep; M12x1.75 - Dodge, Chrysler, Jeep; M11x1.5 - Ford; Nut / Bearing Assembly



SAVE \$5

Offer Good Through June 30, 2017 - While Supplies Last

Harmonic Balancer Remover

SKU 596957 GGT180 **149⁹⁹**

- Time Saving Harmonic Balancer Puller
- Clip-in Compact Design (No Bolts Required)
- Suitable for: GM, 5.3L, 5.7LS1, 6.0LS2, 6.2LS3, 7.0L
- Also fits: Chrysler/Dodge/Jeep 3.5L & 3.6L V6s and 4.7L, 5.7L, & 6.1L V8s
- Radiator Removal Not Required



Specialty Pullers

Steering Wheel Puller Leg Kit

SKU 793567 33627312 **10⁹⁹**

- Steel Construction for Durability
- Includes (2) J Hook Puller Legs and Spacer for Expanded Coverage
- Use with OEM 27017, 33627019, 27182 and Other Popular Pullers



Steering Pivot Pin Remover

SKU 265106 25135 **14⁹⁹**

- Works on 1969 to Current GM, Chrysler and Ford Vehicles with Saginaw Steering Columns



Timing Gear and Pulley Set

SKU 695623 33627009 **16⁹⁹**

- Services Crankshaft Pulleys and Timing Gears on Gasoline and Diesel Powered Engines



Power Steering Pulley Puller/Installer Kit

SKU 141495 25298 **32⁹⁹**

- Fits Pulleys with Hub Diameters Measuring 1-1/8", 1-1/4", 1-5/16" and 1-3/8"



Steering Wheel and Lock Plate Puller Kit

SKU 900821 27182 **39⁹⁹** REG. \$49.99

- Use to Pull Steering Wheels on Many Major Makes of Automobiles
- Includes Yoke, Pressure Screw and Five Sets of Pulling Screws with Washers and Swivel



SAVE \$10

Offer Good Through June 30, 2017 - While Supplies Last

VW®/Audi® Diesel Injector Puller Kit

SKU 548566 27282 **59⁹⁹**

- Remove Diesel Injectors from 1996 to Current VW and Audi Vehicles
- Applications: VW, Audi TDI Engine



Alternator Decoupler Pulley Service Kit

SKU 695085 33627275 **64⁹⁹**

- Allows Alternator Shaft to Be Held While the Pulley Retainer is Removed
- Includes a Special Set of Spline and Star Socket Bits for Removal of Bosch Type Alternator Free-Wheel Drive Pulleys



Slide Hammer Pullers

9 Way Slide Hammer Puller Set

SKU 900825 27191 **99⁹⁹**

- Pulls Flange-Type Rear Axles and Most Front Wheel Drive Hubs
- Internal and External Jaws Provide a Variety of Combinations to Pull Bearings, Gears and Seals
- Two- and Three-Way Cross Blocks
- Includes a Grip Wrench Adapter and a Dent Puller Attachment
- Designed for Use with Other 5/8" - 18 Thread Slide Hammer Attachments



Blind Hole Puller Set

SKU 695118 33627128 **160⁹⁹**

- Pull Blind Hole Bearings, Bushings and Sleeves with Inside Diameters 3/8" - 1-3/8"



Pullers

2 Jaw 5 Ton Gear Puller

SKU 141513 25914 **29⁹⁹**

- Reversible
- Maximum Reach: 3-1/4"
- Maximum Spread: 6"



2/3 Jaw 5 Ton Gear Puller

SKU 231202 25919 **39⁹⁹**

- Reversible
- Maximum Reach: 5-1/2"
- Maximum Spread: 7"



2/3 Jaw 2 Ton Gear Puller

SKU 070134 25901 **34⁹⁹**

- Maximum Reach: 3-1/2"
- Maximum Spread: 4-3/4"
- Center Forcing Screw: 3/8" - 24" x 4-7/8"



Bearing and Pulley Puller Set

SKU 900824 27190 **89⁹⁹**

- Use on Pitman Arms, Timing Gears, Carrier Side Bearings, Crankshaft Pulleys and More



Makes Up to Eighteen Different Pullers!

Power Steering

Universal Air Bleed Adapter

SKU 751699 MITMVA660 **24⁹⁹**

- Helps Remove Trapped Air in the Power Steering System
- Rubber, Cone-Shaped Design
- Seals Pump Necks Ranging from 5/8" Up to 1-5/8" (16 to 41 mm) Internal Diameter
- Works with a Hand Vacuum Pump



Air Bleed Adapter for Ford

SKU 751704 MITMVA662 **29⁹⁹**

- Helps Remove Trapped Air in the Power Steering System
- Seals Ford Power Steering Pump Necks Having an Internal Diameter of 1-1/4" or 2" (32 or 50 mm)
- Works with a Hand Vacuum Pump



90 Degree Air Bleed Adapter

SKU 751710 MITMVA665 **24⁹⁹**



Air Bleed Adapter for GM

SKU 751698 MITMVA661 **29⁹⁹**

- Helps Remove Trapped Air in the Power Steering System
- Designed for Sealing GM Power Steering Pumps with a Two-Tab Cap Design
- Works with a Hand Vacuum Pump



Power Steering Bleeder Kit

SKU 434716 27311 **29⁹⁹**

- Eliminate Trapped Air in Power Steering and Brake Systems Following Repairs or Fluid Changes
- Includes 2 EPDM Tapered Rubber Adapters to Fit Most Power Steering Pumps and Reservoirs, Reservoir Bottle to Protect Hand Vacuum Pumps and 3 Sizes of Brake Bleeder Adapters
- Works with a Hand Vacuum Pump
- Includes Blow Mold Case



Power Steering Vacuum Pump

SKU 463254 THX212 **159⁹⁹**

- Bleeds Trapped Air from Power Steering System
- Tapered Adapter Allows Use on Most Makes and Models





Contact Us:
1-877-AZTool1 Phone
 (1-877-298-6651) *Hablamos Español*

Measuring Tools

Feeler Gauge
 SKU 001927
 25025 **6⁹⁹**

- STORE STOCK**
 • 26 Blades with Laser Etched In/mm



OEM TOOLS

6" Digital Caliper
 SKU 013642
 24680 **12⁹⁹**

- STORE STOCK**
 • Easy-to-Read LED Display
 • Zeroing Feature



OEM TOOLS

X-Tread® Digital Tire Gauge

SKU 186495
 FOW74225500 **22⁹⁹**

- For Tire Tread Thickness Measurement
 • Reads in Inch, Metric and Fractions



Fowler

Magnetic Angle Finder
 SKU 042343
 CEN6494A **22⁹⁹**

- Magnetic Base
 • 1/2 Degree Graduations



Central TOOLS, Inc.
QUALITY AND INNOVATION SINCE 1968

Disc Brake Rotor Micrometer

SKU 607071
 25367 **49⁹⁹**

- STORE STOCK**
 • .001" Accuracy, .0005" Reading
 • Large LCD Display with SAE or Metric Reading
 • Manual Power Off/On



OEM TOOLS

Dial Indicator Set

SKU 186500
 FOW72522101 **69⁹⁹**

- Includes 1" Indicator, Magnetic Base, Plus Rods, Swivel Clamp and Case
 • 2-1/4" Dial, .001" Increments



Fowler

RotoCal® with Twin Conical Anvils

SKU 186492
 FOW74150004 **74⁹⁹**

- Range 0 to 5.5"
 • Reads in Inch, Metric and Fractions
 • 3.5" Jaw Depth for Large Rotors



Fowler

Mini MAG Protractor

SKU 186501
 FOW744224501 **79⁹⁹**

- Embedded Magnets with 35 Lbs. Pull
 • Uses Standard 9V Battery
 • 360 Degree Measuring Range
 • Accuracy ±0.2 Degrees



Fowler

Rotor/Drum Measuring Kit

SKU 186504
 CEN3K301 **79⁹⁹**

- Attaches to Any Caliper on the Lower Jaws
 • Outward Facing Anvils to Inspect Drums
 • Inward Pointing Anvils to Measure Rotors
 • 8" to 13" Range
 • 0 to 6" Digital Caliper Included



Central TOOLS, Inc.
QUALITY AND INNOVATION SINCE 1968

Disc Brake/Ball Joint Gauge

SKU 186496
 FOW72520757 **99⁹⁹**

- Checks Ball Joint Wear and Disc Rotor Run-Out
 • Checks Gear Backlash and Valve Guide Wear
 • 0 to 1" Travel and .001" Graduations



Fowler

Straight Edge 24" x 1/4"

SKU 404660
 CEN6429 **119⁹⁹**

- Measure Head, Block and Flywheel Straightness
 • Precision Ground to ±.001"



Central TOOLS, Inc.
QUALITY AND INNOVATION SINCE 1968

3 Piece Micrometer Set

SKU 186503
 CEN3MI13 **139⁹⁹**

- 0 to 3" Range
 • 3m101: 0 - 1";
 • 3m102: 1 to 2";
 • 3m103: 2 to 3"
 • Set Includes Calibration Tools



Central TOOLS, Inc.
QUALITY AND INNOVATION SINCE 1968

Torque Adaptors

3/8" Drive Digital Torque Adapter
 SKU 362559
 25684 **44⁹⁹**

- REG. \$49.99
 • Range 27 - 135 Nm (238.9-1,194.8 In./Lbs.)

Turn Any Ratchet or Breaker Bar Into a Digital Torque Wrench!
 Offer Good Through June 30, 2017 - While Supplies Last



SAVE \$5

OEM TOOLS

1/2" Drive Digital Torque Adapter

SKU 900805
 25682 **59⁹⁹**

- Range 40 - 200 Nm (29.5-147.5 Ft./Lbs.)
 • Buzzes When Target Torque is Reached



Torque Wrenches

3/8" Drive Torque Wrench 25-250 In./Lbs. Range
 SKU 133657
 25685 **39⁹⁹**

- REG. 49.99
 • 45 Tooth Round Head Ratchet
 • Audible Click When Desired Torque is Reached
 • Both Clockwise and Counterclockwise Operation

3/8" Drive Torque Wrench 10-100 Ft./Lbs. Range
 SKU 133658
 25686 **49⁹⁹**

REG. 49.99
 • 45 Tooth Round Head Ratchet
 • Audible Click When Desired Torque is Reached
 • Both Clockwise and Counterclockwise Operation



Offer Good Through June 30, 2017 While Supplies Last



3/4" Drive Professional Micrometer Torque Wrench, 80-400 Ft./Lbs. Range

SKU 850046
 33627309 **349⁹⁹**

- Range: 86-400 Ft./Lbs.
 • Torques in Both Directions
 • Positive Lock with Spring-Loaded Pull Down Lock Ring
 • Torques in Both Directions

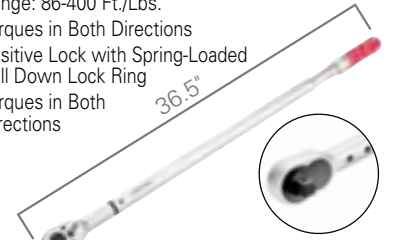

Great for 2004-2008 Ford F150 Brake Rotor and Hub Assembly Replacement

1/2" Drive Professional Micrometer Adjustable Torque Wrench

SKU 133659
 25687 **69⁹⁹**

- REG. 79.99
 • Heavy Duty 24 Tooth Pear Shaped Ratchet Head
 • Audible Click When Desired Torque is Reached
 • Both Clockwise and Counterclockwise Operation



Offer Good Through June 30, 2017 - While Supplies Last

3/4" Drive Professional Micrometer Torque Wrench 100-600 Ft./Lbs. Range

SKU 217376
 25688 **349⁹⁹**

- Right Hand Direction

Micrometer Click Style



Torque Multipliers

3/4" Drive Torque Multiplier

SKU 191056
 25683 **249⁹⁹**

- REG. 299.99
 • Converts Low Torque (Max. 650 Ft./Lbs.) to High Torque (2,200 Ft./Lbs. / 3,000 Nm) With Planetary Gear Set for Heavy Duty Tightening and Loosening
 • Input Drive: 3/4", Output Drive 1"
 • Comes with a 3/4" Drive 2 Way Quick Release Ratchet

Offer Good Through June 30, 2017 While Supplies Last



SAVE \$50

Torque Screwdriver

1/4" Drive Torque Screwdriver

SKU 695088
 33627172 **79⁹⁹**

- Range: 10 - 50 In./Lbs.
 • Great for Low Torque Applications
 • Easy-to-Read Window Scale



OEM TOOLS

25-250 Ft./Lbs. Range

Sensor Sockets

Oil Pressure Switch Socket

SKU 141490
 25254 **11⁹⁹**

- STORE STOCK**
 • Fits Most 1" and 1-1/16" Switches
 • Accepts Oil Pressure Sending Units Up to 2-5/8" Long



3/8" Drive Oxygen Sensor Socket

SKU 047738
 25001 **12⁹⁹**

- STORE STOCK**
 • For Use with 3/8" Drive Ratchet or 1" Wrench
 • Removes and Installs Oxygen Sensors on All Domestic and Imported Computerized Engine Controlled Vehicles
 • Cutaway Slot Provided in the Side for Sensor Wire Clearance
 • Durable Alloy Steel Construction



Water Sensor Wrench Fits Aftermarket Sensors

SKU 459101
 LIS34910 **16⁹⁹**

- Removes and Installs the Aftermarket Water Sensor Located on the Fuel Filter on 2001 - 2011 6.6L Duramax Diesel Engines



Water Sensor Wrench

SKU 459099
 LIS34900 **16⁹⁹**

- Removes and Installs the Water Sensor Located on the Fuel Filter on 2012 and Newer 6.6L Duramax Diesel Engines



Oxygen Sensor Socket Set

SKU 695125
 33627110 **25⁹⁹**

- Universal Slotted Socket to Service Hex Vacuum Switches and Oxygen Sensors
 • 3/8" and 1/2" Drive, 22 mm / 7/8"



Oxygen Sensor Wrench

SKU 947305
 33625246 **29⁹⁹**

- STORE STOCK**
 • Use with Oxygen Sensors on Ford 4.6 and 5.4 Engines
 • 7/8" / 22 mm Used in SUVs and Light Trucks



IPR Socket

SKU 080593
 LIS68210 **29⁹⁹**

- Used to Remove and Replace the Injector Pressure Regulator (IPR) on Ford 6.0L and Other Diesel Engines
 • Designed to Bottom Out on the Hex So it Does Not Put Torque on the Connector in Case it Can Be Reused



7 Piece Sensor Socket Set

SKU 900823
 27189 **59⁹⁹**

- For Removal and Installation of Hard to Reach Oxygen Sensors, Oil Pressure Switches, Oil Pressure Sending Units and Thermal Sensor Switches



OEM TOOLS

SERVICE TOOLS

Exhaust Tools

Exhaust Manifold Spreader Set

SKU 504028
25253TWO **22⁹⁹**

- Used for Reinstalling the Manifold on Small-Block Chevrolets
- Simple Way to Expand Warped Manifold to Align Bolt Holes
- Helps Prevent Cross-Threading of Manifold Bolts
- Works Best When Used in Pairs or Install Before Removing Manifold to Prevent Misalignment



OEM TOOLS

Tailpipe Cutter

SKU 695599
33627045 **50⁹⁹**

- Use to Cut Tailpipe
- Range 3/4" to 3-1/4" (19 - 83 mm)



OEM TOOLS

Pipe Stretcher Kit

SKU 080137
LIS17350 **274⁹⁹**

- Expands All Types of Exhaust Pipe, Including Stainless Steel, from 1-5/8" to 4-1/4" in Size
- Use with Impact Wrench to Quickly Stretch Pipes



1-1/2" x 2-7/16" Tailpipe Expander

SKU 695615
33627027 **25⁹⁹**

2-1/8" x 3-7/16" Tailpipe Expander

SKU 695614
33627028 **35⁹⁹**

- Expands Tail Pipes So Mufflers and Tail Pipes Can Be Fitted to the Exhaust System



OEM TOOLS

Thread Repair



2 Piece External Thread Repair Set 5/32" - 1-1/2"

SKU 343361
NES1000* **199⁹⁹**

- Includes the NES1A and NES2
- Restores Inch or Metric, Right or Left Handed Fastener Threads

*NES Set Comes with Extra Blades



External Thread Repair 5/32" - 1/2"

SKU 343360
NES6040 **39⁹⁹**

- Restores Inch or Metric, Right or Left Handed Fastener Threads



External Thread Repair 5/32" - 11/16"

SKU 343365
NES1A **74⁹⁹**

- Also Repairs Damaged Threads on Pipes Up to 7/16"



External Thread Repair 11/16" - 1-1/2"

SKU 343366
NES2 **104⁹⁹**

- Restores Inch or Metric, Right or Left Handed Fastener Threads



Internal Thread Repair

5/16" - 7/16"
SKU 343367
NES21 **84⁹⁹**

1/2" - 5/8"
SKU 343369
NES22 **84⁹⁹**



Scan the QR Code for More Info on NES Thread Repair Products

Thread Chasers

Spark Plug Hole Thread Chaser

SKU 070109
25124 **6⁹⁹**

STORE STOCK

- Double End for 14 mm and 18 mm
- For Use with 13/16" Deep Sockets
- Cleans Spark Plug Threads of Dirt and Carbon Build-Up



Limited Access Spark Plug Chaser

SKU 607068
25155 **12⁹⁹**

STORE STOCK

- Narrow Profile and Long Length Allows Access to Spark Plug Holes in Confined Spaces
- Use with a 3/8" Ratchet or Extension
- Size: M14 x 1.25



Oxygen Sensor Thread Chaser

SKU 607067
25255 **13⁹⁹**

STORE STOCK

- Use with 3/8" Hex Socket or 3/8" Square Drive
- Size: M18 x 1.5



OEM TOOLS

Tubing

Mini Tubing Cutter

SKU 532507
25058 **8⁹⁹**

STORE STOCK

- Capacity: 1/8" to 7/8"
- Cutter is Capable of Turning on a 1-7/8" Radius
- Lightweight for Easy Handling



Tubing Cutter

SKU 141489
25299 **7⁹⁹**

STORE STOCK

- Cuts Tubes Capacity: 1/8" to 1-1/8"
- Die Cast Frame with Reamer
- Alloy Steel Cutting Wheel
- Large, Easy Grip Knob with 1/8" to 1-1/8" Two Facing Flare Groove Rollers



Multi-Purpose Tubing Bender

SKU 390889
25179 **14⁹⁹**

STORE STOCK

- Works on 1/4", 5/16" and 3/8" (4, 6, and 8 mm) O.D. Copper, Aluminum and Stainless Steel Tubing
- Used to Make Left, Right and Offset Bends Up to 90 Degrees



OEM TOOLS

Double Flaring Tool

SKU 864647
25358 **21⁹⁹**

STORE STOCK

- Includes Five Adapters: 3/16", 1/4", 5/16", 3/8" and 1/2" (4.8 mm Through 12.7 mm)



In-Line Flaring Tool Kit

SKU 238197
24364 **24⁹⁹**

STORE STOCK

- Use on Thin Walled Steel and Copper Tubing
- Low Profile Design Allows for Use On or Off the Vehicle
- 3/16" and 4.75 mm Tubing
- Double Clamp and Hex Screw Keeps Tubing Locked Tightly in Position



Create a Perfect Flare Every Time!

Double Flaring Tool

SKU 695622
33627015 **30⁹⁹**

- Produces Single and Double Flares in Soft Steel



Bubble Flaring Tool Kit

SKU 592261
27214 **39⁹⁹**

NEW

- Designed for Metric Soft Steel Brake Lines Where an "ISO" Or Bubble Style Flare is Required
- Flaring Bar and All the Adapters Needed For ISO Bubble Flaring
- Includes Four Dies 4.75, 6, 8, and 10 mm



Fuel

Fuel Pump Module Spanner Wrench

SKU 110278
25156 **19⁹⁹** REG. \$24.99

- Removes and Installs the Fuel Pump Retaining Ring

SAVE \$5



Offer Good Through June 30, 2017 While Supplies Last

Fuel Tank Lock Ring Tool

SKU 751721
24398 **59⁹⁹**

- For 2004 - Newer Ford F150 Trucks; 2004 or Newer Chrysler/Dodge Mini-Vans, PT Cruiser, Dakota, Durango; 2004-Newer Chevy 1/2 Ton and 3/4 Ton Trucks
- Works with 1/2" Drive Ratchet or Breaker Bar



OEM TOOLS

Spark Plug Installation

Heavy Duty Spark Plug Boot Pliers

SKU 390900
25542 **9⁹⁹**

STORE STOCK

- Designed to Remove Hard-to-Reach Spark Plug Boots
- Has 45 Degree Offset Jaws for Easy Gripping of Wires and Boots
- Vinyl Coated Grips for Comfort
- Do Not Use When the Engine is Running

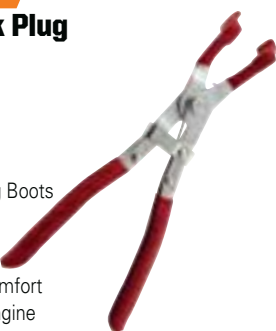

3/8" Drive 9/16" Spark Plug Socket

SKU 265110
25259 **22⁹⁹**

- 10" Long with Thin Wall Design to Reach Into the Cylinder Head
- Fits 2004-Newer Ford F-150 Pick-Up Trucks with 5.4L 3-Valve Triton V-8 Engines
- Chamfered Ends
- Chrome Plated to Resist Rust



OEM TOOLS

SCHRADE



- Assisted Open, Finger Hole
- 2.5" 4034 Stainless Steel Blade
- 3.4" Black Aluminum Handle

SKU 452993
SCHSA3DB **47⁹⁹**

* Products advertised may be considered illegal and may not be lawful to sell, purchase or own in specific areas.



M.A.G.I.C. KNIFE

- Assisted Open, 40% Serrated
- 3.4" 4034 Stainless Steel Blade
- 4.3" Aluminum Handle

SKU 452998
SWMP6S **63⁹⁹**

* Products advertised may be considered illegal and may not be lawful to sell, purchase or own in specific areas.

DID YOU KNOW?

AutoZone® has instrument clusters available.

Contact Your AutoZone Commercial Sales Manager for Details

THREAD REPAIR



Contact Us:
1-877-AZTool1 Phone
 (1-877-298-6651) *Hablamos Español*

Spark Plug Thread Repair

14 mm Tapered Spark Plug Thread Repair Kit

SKU 141511
25647 **29⁹⁹**



STORE STOCK

- Can Be Used to Repair Both Taper Seat and Gasket Type Spark Plug Assemblies
- Three Insert Lengths are Available to Accommodate Most Spark Plug Reaches
- Positive Mechanical Locking Feature Means the Insert Will Never Come Out
- The Piloted Reamer Tap Means No Drilling is Necessary and Perfect Alignment of the Tapped Hole

14 mm Tapered Spark Plug Inserts

SKU 141512
25648 **11⁹⁹**



STORE STOCK

- 6 Pieces in Three Lengths: M14 - 1.25
- Drill Size: 14.25 mm; 9/16"

M14 - 1.25 Spark Plug Thread Repair System

SKU 557108
25643 **29⁹⁹**

STORE STOCK

- Replaces Threads for 14 mm Spark Plug
- Kit Includes: 3 Thread Inserts, Thread Installer Tool and Thread Tap
- Size: M14 - 1.25
- Not for Tapered Spark Plugs



M12 - 1.25 Spark Plug Thread Repair Kit

SKU 789141
25640 **44⁹⁹**

- Kit Includes: 3 Thread Inserts, Thread Installer Tool and Thread Tap

- Designed for Rethreading in All Materials Such as Alloys, Steels, Plastics, Magnesium, etc.
- Specified for Military, Aviation and Other Critical Usage
- Inserts are Made from High Quality 18-8 Stainless Steel Wire with a Diamond Shaped Cross Section Wound to the Shape of a Spring Thread
- Not for Tapered Spark Plugs



Drain Plug Repair

Drain Plug Repair Kit

SKU 818569
CAL38400 **79⁹⁹**

- Designed to Repair Aluminum Oil Pans with Damaged Drain Plug Threads, Size M12 x 1.75 Commonly Found in GM, Ford and Mazda Vehicles

- Drain Plug Repair Kit Contains a Drill, Counter Bore, Tap, Driver, Guide and (5) 12 mm Inserts
- Repairs Stripped Drain Plugs without Leakage and Allows Users to Use Original Plug Instead of a Replacement

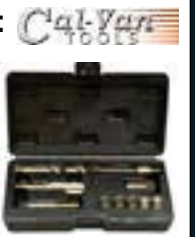

5 Pack Drain Plug Inserts

SKU 850539
CAL384-5 **19⁹⁹**



Thread Repair

3 Piece Internal/External Thread Repair Set

SKU 343362
NES1015 **249⁹⁹**

- Includes the NES1A, NES21 and NES22 Restores 1/2" or Metric, Right or Left Handed Fastener Threads

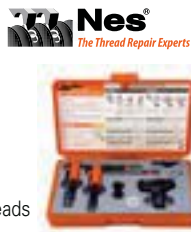

Oxygen Sensor Thread Repair Kit

SKU 010134
FIX38189-1 **99⁹⁹**

- No Need to Replace Exhaust Manifold
- Pilot Nose Tap Provided
- Easy and Quick to Use, Repairs in Minutes

FIX-A-THRED



Metric Head Bolt Thread Repair Kit

SKU 010131
FIX35119S **149⁹⁹**

- Applications - Cadillac, Honda, Toyota and Other Imports
- Extended Reach for Deep Threads
- Longer Length (33 mm) Inserts for Maximum Thread Engagement

FIX-A-THRED



Metric Thread Repair Kits

*STORE STOCK

SKU	Part No.	Size	Price	SKU	Part No.	Size	Price
516472*	25626	M6 - 1	29.99	516473*	25627	M6 - 1	6.99
516474*	25628	M8 - 1.25	29.99	516475*	25629	M8 - 1.25	7.99
516477*	25632	M10 - 1.5	29.99	516478*	25633	M10 - 1.5	7.99



Replacement Inserts

*STORE STOCK



SAE Thread Repair Kits

*STORE STOCK

SKU	Part No.	Size	Price	SKU	Part No.	Size	Price
557009*	25602	UNC 1/4" - 20	22.99	557116*	25603	UNC 1/4" - 20	6.99
557017*	25604	UNC 5/16" - 18	22.99	557124*	25605	UNC 5/16" - 18	6.99
557090*	25606	UNC 3/8" - 18	22.99	557132*	25607	UNC 3/8" - 16	7.99
516464*	25608	UNC 7/16" - 14	29.99	516465*	25609	UNC 7/16" - 14	7.99
516467*	25610	UNC 1/2" - 13	29.99	516468*	25611	UNC 1/2" - 13	9.99

Replacement Inserts

*STORE STOCK

OEM TOOLS

Drill Bits and Extractor Sets

6 Piece Spiral Flute Screw Extractor Set

SKU 099277
24374 **14⁹⁹**

- Extractors: Ex-1, Ex-2, Ex-3, Ex-4, Ex-5 and Ex-6
- M2 Steel
- Comes in a Vinyl Pouch



10 Piece Bolt Extractor Set

SKU 231204
25467 **19⁹⁹**

STORE STOCK

- (5) Mechanic's Length R.H. Cobalt Drill Bits
- Set Includes Extractors Size: #1, #2, #3, #4, #5 and Bits: 5/64", 7/64", 5/32", 1/4" and 19/64"



10 Piece Multi-Spline Screw Extractor Set

SKU 099281
24375 **39⁹⁹**

- Contains Sizes from 1/8" - 13/32" in 1/32" Increments
- Can Be Used with Hand Sockets and Wrenches
- Constructed of High Carbon Steel for Strength Under Stressful Conditions
- Aggressive Left Hand Spiral Design Provides Extra Gripping Power



10 Piece Spiral Extractor and Drill Bit Combo Pack

SKU 099229
24373 **29⁹⁹** REG. \$39.99

- Extractors: Ex-1, Ex-2, Ex-3, Ex-4 and Ex-5
- Left Hand 135 Degree Split Point Cobalt
- Drill Bit Sizes: 5/64", 7/64", 5/32", 1/4" and 19/64"
- Aggressive Left Hand Spiral Design for Extra Gripping Power
- Pilot Point Starts on Contact and Eliminates Bit Walking



SAVE \$10

Offer Good Through June 30, 2017 - While Supplies Last

25 Piece Screw Extractor/Drill and Guide Set

SKU 099215
24376 **39⁹⁹**

- Can Be Used on Thread Sizes 5 mm to 16 mm
- Comes in a Blow Mold Case
- Turns Broken Fastener Out and Permits Highest Torque without Expansion

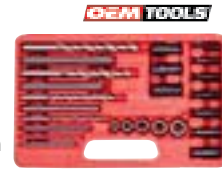

3 Piece Double Edge Bolt and Screw Extractor Set

SKU 042367
KNP9R4719033 **29⁹⁹**

- Contains Sizes 1-3 in a Plastic Tube
- Tip Has Built-In Center Punch
- No Additional Tool Required



5 Piece Double Edge Bolt and Screw Extractor Set

SKU 042353
KNP9R4719043 **59⁹⁹**

- Contains Sizes 1-5 in a Plastic Tube
- Tip Has Built-In Center Punch
- No Additional Tool Required



35 Piece Master Screw Extractor/Drill Bit Set

SKU 099258
24377 **149⁹⁹**

- Full Range of Spiral and Multi-Spline Extractors for Removing the Toughest Bolts and Screws from 3/32" to 15/16"
- OEM 135° Split Point Left Hand Cobalt Drill Bits, Start Easy and Drill the Toughest Metals



Spark Plug Thread Repair for Ford Triton

Ford Spark Plug Porcelain Extractor Set

SKU 104290
24202 **29⁹⁹**

- Use to Extract the Broken Porcelain from Broken Spark Plugs in 2003 to Current Ford Triton Engines
- In Some Cases the Porcelain Will Break Off in the Sleeve and Will Need to Be Extracted in Order for the 24201 to Function Effectively
- Unlike Other Tools That Tell You to Push the Porcelain Through the Sleeve (Ford Says Specifically Not to Do This) This Tool Adheres to the Porcelain Using a Special Adhesive and Then Allows a User to Extract the Broken Porcelain from the Sleeve



Loctite 60800 5 mL Replacement Adhesive

SKU 248475
24204 **15⁹⁹**



Replacement Pins

SKU 248476
24205 **16⁹⁹**



Ford Spark Plug Extractor Set

SKU 104286
24201 **84⁹⁹**

- Works to Extract Frozen and Broken Off Spark Plug Sleeves in 2004 to Present Ford Triton Engines
- Specially Machined Guide Works with Extra Long Tap and Extractor to Make Sure the Job is Done Right



Ford Triton Plug-Saver® Kit

SKU 094873
FIX98140T **149⁹⁹**

- Designed to Specifically Repair the Spark Plug Ports in 4.6, 5.4 and 6.8 Ford Triton Engines
- Repairs Worn, Damaged Threads
- Self Cutting Tap
- Includes Tap, Tool and Eight Inserts in a Sturdy Case



Broken Spark Plug Remover Ford Triton 3 Valve

SKU 489173
LIS65600 **99⁹⁹**

- Includes a Unique Porcelain Pusher Tool and a Tapered Left Hand Thread Remover for Removing the Broken Spark Plug without Leaving the Porcelain in the Engine Cylinder



FIX-A-THRED

Inserts (Pack of 8)
SKU 110263
FIX98149P **27⁹⁹**

Ford Cylinder Head Repair Set

SKU 104283
24200 **259⁹⁹**

- Repair Ford Triton Modular Engines (1996 - 2003) with Spark Plug Thread Erosion
- Current Repair Takes About 10 Labor Hours, This Tool Cuts Time to 30 Minutes to an Hour
- Works on Ford 4.6, 5.4, 6.8 V10 Engines
- Individual Inserts Available as Part Number 24203; The Patented Replacement Insert is a Permanent Fix That Does Not Have to Be Replaced with Every Tune-Up
- Patented Guide Makes Drilling and Tapping in a Straight Line Easy
- Set Includes: Instruction Sheet, DVD, (6) Inserts, Reamer Tap, Drill Bit, Expanding Tool and Air Blower Accessory Assembly

Comes with Instructional Video



Ford Triton 14 mm x 1.25 Repair Insert

SKU 104287
24203 **34⁹⁹ each**

- Alloy Steel Insert - Not Aluminum
- Seals Perfectly and Prevents Any Loss of Compression
- Taper on the Inside of the Insert That Seats the Spark Plug



Ford Triton M16 x 1.5 3 Valve Insert

SKU 396658
CAL393-100 **22⁹⁹ each**

- Note: THIS IS NOT the Replacement Insert for the Triton 2 Valve Kit



Ford Triton 3 Valve Set

SKU 343388
CAL39300 **299⁹⁹**

- Application: 2004-2008 Ford 4.6 and 5.4 3 Valve Engines That Have Spark Plugs That are M16 x 1.5
- Includes (8) Inserts



SPECIALTY TOOLS

Circuit Tester

Computer Safe Circuit Tester

SKU 222515 **22⁹⁹**
LIS24550

- Indicates Polarity
- Draws Less Than 21 mA at 12 Volts DC
- Operating Range: 3 - 28 Volts



Digital Display Circuit Tester

SKU 568468 **49⁹⁹**
24451

- Detect Voltage, Power, Ground and Circuit Condition
- Display Provides Precise Voltage
- Voltage: 5-30V DC
- Computer Safe - Do Not Use on Airbags



Voltage Display

Radio Remover

Radio Remover

SKU 222508 **16⁹⁹**
LIS11770

- Disengages Radio Retaining Clips on Fords and Imports for Removal

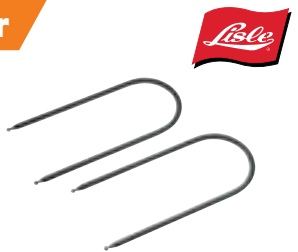

Remote Starters

Remote Starter Switch

SKU 265124 **19⁹⁹**
25330

- Heavy Clips with Insulated Sleeves Attach to Ground and Starter Solenoid Switch
- Thumb Activated Switch
- 6' Heavy Insulated Wire for Long Tool Life



Terminal Tools

Wire Terminal Tools

SKU 191676 **19⁹⁹**
25228 (Green)

SKU 255953 **19⁹⁹**
25229 (Red)

- Fits Most GM and Domestic Motors, Computer Connectors and Terminals
- Designed to Remove Wires from Terminals without Damaging Either
- Prongs Depress the "Barbs" on Conventional Terminals

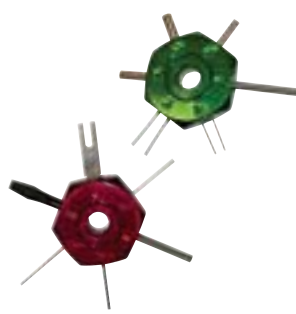

Deutsch Terminal Tool

SKU 222527 **32⁹⁹**
LIS59600

- Works on OEM Electrical Connectors Used on Trucks and Equipment: Caterpillar, Kenworth, Peterbilt, Freightliner, Mack and More

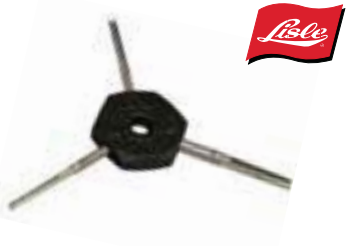

19 Piece Master Terminal Tool Kit

SKU 447159 **109⁹⁹**
27169

- Latest Tools for Coolant Sensors, Wiring Harnesses and Terminal Blocks on Most Modern Vehicles
- Eliminates Potential Damage to Wires or Terminal Blocks
- Application Chart Included Inside Storage Case

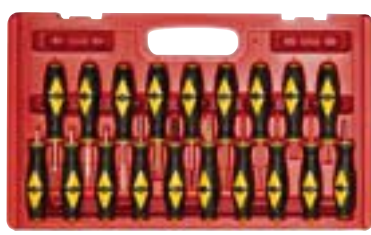

Relay Tools

Relay Puller Pliers

SKU 291342 **23⁹⁹**
LIS46950

- For Removing Electrical Relays on Most Domestic and Import Vehicles
- Allows Relay to Pop Free from Socket with Less Chance of Damaging the Relay



Relay Test Jumper Set II

SKU 291341 **74⁹⁹**
LIS60610

- Set Includes Four Jumpers to Fit Many Popular Relays on Honda, Nissan, Toyota, Newer Ford and GM Mini Micro Relays as Well as International Trucks
- Set Comes in Blow Mold Case for Storage



Relay Test Jumper Set

SKU 291333 **74⁹⁹**
LIS56810

- Set Includes Four Jumpers to Fit the Most Popular Size Relays on Domestic and Import Vehicles
- Jumpers Have Tabs for Clamping and Flat Pads to Place Test Leads On
- Set Comes in Blow Mold Case for Storage



Relay Circuit Tester

SKU 383450 **139⁹⁹**
27211

- Cut Relay Related Diagnosis Time by 75 Percent
- Identify at the Push of a Button if a Wire, a Part, or a Relay is Defective
- Test an Entire Circuit from the Battery to the Component
- Bypass Relays to Do Compression Test, Fuel Pressure Test, A/C Fill, etc.
- Kit Includes: Tester, 5 Popular Relay Leads and 1 Universal Relay Lead
- Comes in a Sturdy Blow Mold Case



Wire Strippers

Wire Cutter/Stripper Combo

SKU 191685 **16⁹⁹**
25192 (Small)

- Used for Soft Copper, Electrical Wires
- Self-Adjusts to Wire Sizes: 14 AWG to 26 AWG
- Grab, Hold and Strip Wire in One Quick Motion
- Jaws are Made of Surgical Steel



Compact 8-14 Gauge Wire Stripper

SKU 751657 **19⁹⁹**
24452

- Strips 20-12 Gauge Insulated and Non-Insulated Wire
- Length: 7"
- Use for Wire Cutting and Stripping, as Pliers for Grabbing and Twisting or for Crimping of Insulated and Non-Insulated Connectors
- Industrial Finish with Red Textured Grips

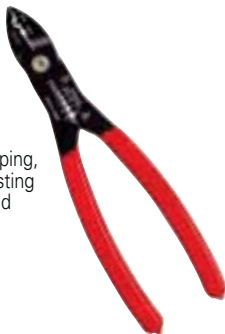

Compact 8-14 Gauge Wire Stripper

SKU 011620 **24⁹⁹**
LIS68280

- Cuts and Strips Insulation from 8 to 14 Gauge Wires
- Crimps 8 to 14 Gauge Terminals
- Wire Gauge Key Markings



Compact 14-24 Gauge Wire Stripper

SKU 011610 **24⁹⁹**
LIS68250

- Cuts and Strips Insulation from 14 to 24 Gauge Wires
- Crimps 14 to 24 Gauge Terminals
- Wire Gauge Key Markings

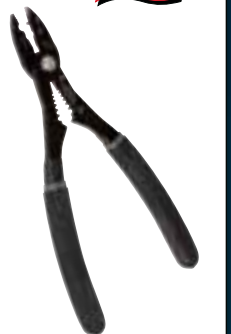

Ignition Tester

In-Line Ignition Spark Tester

SKU 900800 **8⁹⁹**
25227

STORE STOCK

- Quickly Troubleshoot Ignition System
- "Hands-Free" Device Connects In-Line Between Spark Plug and Plug Wire
- Shows a Duplicate View of the Ignition Spark
- Technician Can Visually Check Condition of Ignition System at Each Cylinder



DID YOU KNOW?

AutoZone® has over 60,000 specific replacement part numbers for import vehicles through IMC®

Contact Your AutoZone Commercial Sales Manager for Details

Fuse Buddy™

3-in-1 Tester

SKU 374602 **89⁹⁹**
ESI310

3 Interchangeable Test Functions:

1. 30 Amp MINI Circuit Amperage Testing
2. 30 Amp ATC Circuit Amperage Testing
3. 30 Amp All Purpose Amperage Testing



Fuse Buddy Current Loop Mini
Fuse Buddy Tester Mini 30 Amp
Fuse Buddy Tester ATC 30 Amp



SKU 374610
SKU 374613
SKU 374603



ESI307M
ESI305M
ESI306B

24⁹⁹
29⁹⁹
29⁹⁹



Contact Us:
1-877-AZTool1 Phone
 (1-877-298-6651) *Hablamos Español*

Lockout Tools



BigEasy™ Loop

SKU 964492 **17⁹⁹**
 STK32903

- Clips to Any BigEasy to Allow Grabbing of Door Handles and Locks, it Even Glows in the Dark
- Provide Easy Leverage to Pull Door Handles and Window Cranks During the Door Unlocking Process
- Handy Accessory Tool Easily Snaps on the End of the BigEasy Tool Avoiding Need to Purchase Additional, More Costly Specialty Tools



BigEasy™ Carrying Case

SKU 227873 **29⁹⁹**
 STK32935

- Made of Soft, Yet Firm Material to Protect Your BigEasy Kit
- Custom Pockets for the BigEasy, Non-Marring Wedge, Lock Knob Lifter and Easy Wedge
- Makes it Convenient to Stow Your BigEasy Kit in Your Truck



BigEasy™ Easy Wedge (Inflatable)

SKU 964493 **34⁹⁹**
 STK32922

- Inflatable Controlled Opening of Car Door for Insertion of the BigEasy



BigEasy™ Lockout Tools Kit

SKU 964491 **39⁹⁹**
 STK32900

- High Visibility Pink Powder Coating and Improved Non-Marring Wedge
- Lock Knob Lifter for Cars with Flat Lock Knobs at the Top of the Door
- Paint Protector Reduces Friction Between the Car Door and the BigEasy



BigEasy™ Glo with Easy Wedge Lockout Kit

SKU 964494 **74⁹⁹**
 STK32955

- Glow-in-the-Dark Yellow Allows You to See the Tool at Night or Through Tinted Windows
- Easy Wedge Offers Controlled Opening of the Car Door for Inserting the BigEasy Glo



Shop Tools



Angle Tip Lock Ring Pliers

SKU 191055 **16⁹⁹**
 25354

- Jaws are Scored on the Outside for Secure Gripping
- Spring Loaded Jaws
- Spread: 3/4"
- Length: 8-1/4"



Snap Ring Pliers

SKU 011600 **24⁹⁹**
 LIS46200

- Reversible Action for Both Internal and External Snap Rings
- Includes 4 Pairs of Tips
- 45 and 90 Degree Conical Tips

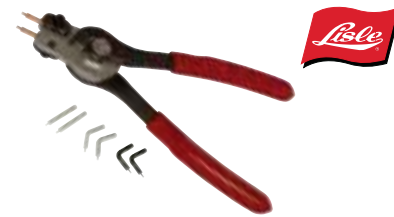

4 Piece 15" Jumbo Pick Set

SKU 094658 **24⁹⁹** Reg. \$29.99
 25940

- Includes: Straight, 90°, Offset and Hook Pick
- Chrome Vanadium Steel for Strength and Durability
- Black Oxide Finish to Resist Rusting
- Cushion Grip Handles



SAVE \$5

Offer Good Through June 30, 2017 - While Supplies Last

10 Piece Snap Ring Plier Set

SKU 900819 **61⁹⁹**
 27180

- For Both Internal and External Rings
- Set Includes: 5-1/2" Bent Pliers with .038" Tip; 6" Straight Pliers with .038" Tip; 5-1/2" Bent Pliers with .047" Tip; 6" Straight Pliers with .047" Tip; 7-1/2" Bent Pliers with .070" Tip; 8" Straight Pliers with .070" Tip; 8-1/2" Bent Pliers with .090" Tip; 9" Straight Pliers with .090" Tip
- Also Includes Two Stainless Steel Handle Picks



Power • Precision • Style

<h4>8 Pc. ZEON Socket Sets</h4> <p>SKU 15891/941322A - MM SKU 15897/941323A - SAE 14⁹⁹ each</p> <ul style="list-style-type: none"> - Patented design sockets grip tighter as they turn - Works on standard & up to 85% rounded fasteners 	<h4>Ratcheting Caliper Piston Tool</h4> <p>SKU 52485 44⁹⁹ 647861</p> <ul style="list-style-type: none"> - Size range: 1-1/2" to 2-5/8" - Works on most single & multi piston calipers - Includes magnetic 7" long extended adapter plates for large multi piston calipers on heavy duty vehicles 	<h4>2 Pc. Stretch Belt Tool</h4> <p>SKU 15927 9⁹⁹ 647886</p> <ul style="list-style-type: none"> - Installs and removes stretch belts - Easily installs all stretch fit belts - Allows for removal, inspections & reuse of stretch fit belts 	<h4>8" Combo Snap Ring Pliers</h4> <p>SKU 15929 19⁹⁹ 941456</p> <ul style="list-style-type: none"> - Quick switches in seconds - Switches from EXTERNAL to INTERNAL - Tips secure with hex key 	<h4>Magnetic Drain Plug Remover</h4> <p>SKU 15928 17⁹⁹ 942072</p> <ul style="list-style-type: none"> - Adapters store in handle - Doubles as flex bit driver - Includes 1/4" drive bit coupler 	<h4>3/8" Dr. Swivel Head Ratchet</h4> <p>SKU 15889 19⁹⁹ 649941</p> <ul style="list-style-type: none"> - 72 tooth mechanism - Compact swivel head design can work in different angles and tight spaces
---	--	---	--	--	--

Rivet Tools

SAVE \$5



Industrial Riveter

SKU 291353 **44⁹⁹** REG. \$49.99
 25921

- For Use with Steel and Aluminum Rivets
- Noses: 1/8" (3.2 mm), 5/32" (4.0 mm), 3/16" (4.8 mm), 1/4" (6.4 mm)
- 18" Overall Size with Long Handle Provides More Leverage



Offer Good Through June 30, 2017 - While Supplies Last

Deluxe Riveter Kit

SKU 094877 **39⁹⁹**
 MAR39001KIT

The Choice of Professionals

- Kit Includes: HP-2 Riveter. Sets Up to 3/16" Diameter Rivets, (200) Rivets and Molded Case
- 39003 Same as 39001 But Contains (200) Assorted Klik-Fast Stainless Steel Rivets



SKU 094879 **39⁹⁹**
 MAR39003KIT
 Stainless Steel

KLICK-LOK Plastic Rivet Setter

SKU 222531 **59⁹⁹**
 MAR48005

- Includes a Universal Nose Piece That Sets All Plastic Rivets



Big Daddy® Hand Riveter

SKU 094886 **139⁹⁹**
 MAR39031

The Big Daddy is the Most Versatile and Powerful Hand Riveter. Sets Large Diameter Blind Rivets.

- Double Gear Reduction System Easily Sets from 1/8" to 1/4" Diameter Klik-Fast Rivets in All Alloys Including 1/4" Klik-Split® Rivets
- Comes with 5/32", 3/16" and 1/4" Nose Pieces Stored in the Body



Air Over Hydraulic Powered Rivet Tool

SKU 222750 **449⁹⁹**
 MARAK-175

- Sets 1/8" - 1/4" Steel Rivets with Up to 3,500 Lbs. of Pull Capacity
- Unique Jaw System Accommodates 1/8" - 1/4" Rivet Sizes by Simply Changing the Nose Assembly (No Tools Required)



SPECIALTY TOOLS

Windshield Tools

Window Molding Clip Remover

- SKU 265130 25338 **14⁹⁹**
- Use to Release Body Molding Clips
 - The Double-Sided Design Works on a Variety of Clip Configurations
 - Made with Heat-Treated Carbon Steel for Strength



Windshield Wiper Arm Puller

- SKU 191681 25319 **15⁹⁹**
- Easily Removes Wiper Arms on Most Domestic and Foreign Vehicles



Double Head Suction Cups

- SKU 291351 24246 **16⁹⁹**
- Twin Head Suction Cups Help Remove Windshields
 - ABS Rubber Cups Grab Hold to Glass
 - Flexible Handle Bends to Windshield



Universal Wiper Arm Puller

- SKU 265136 25339 **29⁹⁹**
- Prevents Damage to Wiper Arm
 - Cross-Piece Special for Wiper Featuring a Nozzle



18" Professional Windshield Knife

- SKU 480782 CAL53100 **24⁹⁹**
- Length: 18"
 - Constructed of Heavy Duty Steel and Aluminum with a Padded Ergonomic Handle



Disconnect Tools

Fuel Line Disconnect Tool

- SKU 246367 25043 **7⁹⁹**
- STORE STOCK**
- Fits Any 5/16" or 3/8" Fuel Line Found on GM, Ford and Chrysler Vehicles



A/C and Fuel Line Disconnect Tool Set

- SKU 246366 25042 **7⁹⁹**
- STORE STOCK**
- Range: A (3/4"), B (5/8"), C (1/2") and D (3/8")



A/C and Fuel Line Quick Connect Tools

- SKU 002356 25052 **9⁹⁹**
- STORE STOCK**
- Easily Disconnects Air Conditioning Lines and Quick Connect Fuel Lines



Ford Clutch Disconnect Tool

- SKU 695116 33627130 **11⁹⁹**
- Works on 1988 to Present Ford Vehicles and Light-Trucks with Hydraulic Clutches



Quick Connect Tools

- SKU 363869 25184 **12⁹⁹**
- STORE STOCK**
- Sizes: 3/8", 1/2", 5/8" and 3/4"
 - Enables Quick and Easy Disconnect of Air Conditioning Couplings



Over-Tank Fuel Pump Disconnect Set

- SKU 695115 33627131 **16⁹⁹**
- Provides Easy Access to Hard to Reach Fuel Line Quick Connectors Found Under the ABS Unit on '92 and Newer GM "W" Body Cars
 - Red Tool Fits 5/16" Return Lines; Blue Tool Fits 3/8" Fuel Inlet Lines
 - Also Works on 1988 and Newer Ford F-Series Pickups to Disconnect the Fuel Lines from the Fuel Sending Unit

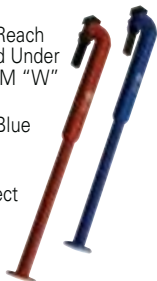

4 Piece Disconnect Set

- SKU 864648 25150 **19⁹⁹**
- STORE STOCK**
- Sizes: 1/4", 5/16", 3/8" and 1/2"



6 Piece Disconnect Set

- SKU 013603 24681 **19⁹⁹**
- STORE STOCK**
- Separates Fittings on Fuel Lines, Fuel Filters, and Fuel Tank Return Lines
 - Oil Cooler Line Disconnect Tool Separates Automatic Transmission Oil Cooler Lines on Ford Taurus and Escort with AXPD and ATX Transmissions
 - Unique Offset Design Allows for Access in Confined or Obstructed Areas
 - Sizes: 5/16", 3/8", 1/2", 5/8", 3/4", and 7/8"



Heater Hose Disconnect Tool

- SKU 695607 33627106 **19⁹⁹**
- Removes Heater Hoses with 1/4" or 5/8" Quick Disconnect Couplings on '86 to Current Ford Aerostar Vans and '01s to Current Full Size Ford Vans
 - Works on Rear Heater Hose Couplings on '87 to Current Chrysler and Plymouth



3 Piece 1/2" Oil Line Disconnect Set

- SKU 094653 25187 **26⁹⁹**
- Used to Remove and Replace Oil and Transmission Cooler Lines on GM, Ford, Nissan and Toyota



15 Piece Master Disconnect Set

- SKU 900807 27195 **34⁹⁹** REG. \$39.99
- Includes Fuel and Transmission Line Disconnect Set, Oil Cooler Line Remover, Air Conditioning and Fuel Line Disconnect Tool

SAVE \$5

Offer Good Through June 30, 2017 While Supplies Last



22 Piece Disconnect Master Set

- SKU 900817 27177 **79⁹⁹**
- Includes Quick Connects Set, Air Conditioning and Fuel Line Disconnect Tools



Master Disconnect Set

- SKU 821445 33627318 **90⁰⁰**
- Easily Disconnects A/C Lines, Fuel Lines and Transmission Cooler Lines
 - Includes: Hydraulic Clutch Line Disconnect for GM, 5/16" and 3/8" Fuel Line Retaining Clips for GM, Air Conditioning/Fuel Line Disconnects: 5/16", 3/8", 1/2", 5/8", 3/4", and 7/8"
 - Scissor Disconnects: 5/16", 3/8" and 1/2", 3/8"
 - Ford: Fuel Line, Oil Cooler Line and Clutch Coupling Remover
 - Coupler Disconnects



4 Piece Disconnect Set

- SKU 948999 25183 **24⁹⁹**
- STORE STOCK**
- Includes: 1/2", 5/8", 3/4" and 7/8"



Fuel Module Disconnect

- SKU 291418 LIS37500 **14⁹⁹**
- Fits Both 3/8" and 5/16" Connectors and Applications
 - Tool Can Be Clipped Together for Convenient Storage



AC/Fuel Line Tool Set

- SKU 222520 LIS37000 **17⁹⁹**
- Set Includes (6) Sizes: 5/16", 3/8", 1/2", 5/8", 3/4" and 7/8"



Angled Disconnect Set

- SKU 291416 LIS39400 **22⁹⁹**
- Disconnects Spring Lock Couplings on Ford and Chrysler A/C Lines
 - Works on Fuel Lines and Other Quick Disconnect Couplings on Domestic and Import Vehicles
 - (6) Sizes: 5/16", 3/8", 1/2", 5/8", 3/4" and 7/8"



Fuel and AC Disconnect Pliers

- SKU 343391 LIS37300 **27⁹⁹**
- Unique Design Provides Extra Leverage When Disconnecting Quick Connect Coupling Air Conditioning and Fuel Lines



Fuel/Transmission Line Disconnect Tool Set

- SKU 526503 WLMW89330 **19⁹⁹**
- Fuel Line Disconnect Tools in Sizes: 1/4", 5/16", and 3/8" Inches
 - Oil Cooler Line Disconnect Tool
 - Fuel Line Coupling Tool
 - Ford and Mercury Oil Cooler Line Disconnect Tool
 - Ford and GM Quick Disconnect Tool



While Supplies Last

Master Disconnect Set

- SKU 452636 WLMW89331 **24⁹⁹** REG. \$39.99
- Performance Master Disconnect Set Includes Disconnect Tools for Air Conditioning, Fuel, Heater, Transmission and Power Steering Lines
 - O.E. Tool Identification Number Included
 - Tools Color Coded for Easy Identification

SAVE \$15



Offer Good Through June 30, 2017 - While Supplies Last

Master Disconnect Tool Set

- SKU 291413 LIS39900 **59⁹⁹**
- Contains (8) Tools for A/C and Fuel Lines
 - Comes in a Blow Mold Case



Low Profile Jiffy-Tite® Disconnect

- SKU 011609 LIS22990 **69⁹⁹**
- Disengages Jiffy-Tite Quick-Connect Fittings
 - No Need to Remove Retaining Clips
 - Includes Four Sizes: 3/8", 1/2", 5/8"-30% and 5/8"-39%



Coolant Hose Removal Tool Set

- SKU 383214 CAL244TNZ **29⁹⁹**
- Used to Completely Fill the Void in the Connector to Release the Fastener
 - 40° Offset Designed for Jobs Up Against the Firewall or in Tight Spaces



Airsept Smart Splice Multi System Line Repair Tray

- SKU 687973 AIR76076 **524⁹⁹**
- Includes: 1 Each 5/16", 3/8", 1/2", 5/8", 3/4" Line Splice Straight SAE Repair Kits; 1 each 8 mm, 10 mm, 12 mm, 15 mm, 16 mm Line Splice Straight Metric Repair Kits; 1 each 5/16", 3/8", 1/2", 5/8" Line Splice 45° SAE Repair Kits; 1 each 5/16", 3/8", 1/2", 5/8" Line Splice 90° SAE Repair Kits
 - Covers All Standard Automotive Line OD Sizes



Airsept Smart Splice Ultimate Line Repair Kit

- SKU 687976 AIR76057 **1,769⁹⁹**
- Everything Needed to Repair A/C, Power Steering Return, Transmission, Trans Oil Cooler, Engine Oil, Engine Oil Cooler, Coolant and Heater Lines
 - OEM Approved Line Repair Solution Installs in Five Minutes, on the Vehicle, without Special Tools or Adhesives
 - Leak Free Up to 2,600 PSI





Contact Us:
1-877-AZTool1 Phone
 (1-877-298-6651) *Hablamos Español*



READY TO RIDE

Avoid the traditional hassles of Power Sports battery handling, preparation, and installation.

EASY

Factory Charged

SAFE

*Won't spill,
no adding acid*

FUN

Enjoy maximum power

*Patented heavy-duty
top and side connection
terminals*



POPULAR FITMENT GUIDE:

SKU #	Stock Number	Motorcycle	PWC	ATV	Snowmobile	Utility Vehicle
350076	ETX9	X		X		
350077	ETX12	X		X		X
350083	ETX14	X		X	X	X
350066	ETX14L	X				
350078	ETX15	X		X	X	X
350079	ETX15L	X	X	X	X	
350080	ETX16	X	X	X	X	
350081	ETX16L	X	X	X	X	X
350084	ETX18L	X		X	X	X
178908	ETX20L	X	X	X	X	X
273069	ETX30LA	X	X	X	X	X

**A full coverage line,
in stock and ready to go!**



Socket Sets

5 Piece Mortorq® Super Socket Set

SKU 750019 78-140 **49⁹⁹**

- Sizes: M0, M1, M2, M3, M4, Services New Fasteners Found on GM, Chrysler, BMW, Nissan, etc.



Duralast

STORE STOCK

Ratchets

Round Head Ratchets

- CR-V Steel • Knurled Grip

Duralast

3/4" Drive Round Head Ratchet

SKU 914050 72-130

36⁹⁹

STORE STOCK



3/8" Drive Stubby Ratchet

SKU 482540 73-872

22⁹⁹

STORE STOCK



3/8" Drive Comfort Handle Ratchet

SKU 482541 73-873

24⁹⁹

While Supplies Last

1/2" Drive Comfort Handle Ratchet

SKU 557430 72-127

24⁹⁹

STORE STOCK



3/8" Drive Super 72 Ratchet

SKU 454285 73-879

26⁹⁹

- Sealed Head Keeps Dust and Dirt Out
- 72 Teeth, Fine-Tooth Design Offers 5° Backlash
- Quick Release for Secure Holding of Sockets
- One Finger Reverse Switch

1/2" Drive Super 72 Ratchet

SKU 454286 72-131

29⁹⁹

1/4" Quick Release Ratchet

SKU 013649 71-420

17⁹⁹

1/2" Drive Breaker Bar 24"

SKU 560039 72-124

19⁹⁹

- Flexhead Drive • Socket Retainer



While Supplies Last

3/8" Ratchet with 1/4" Body

SKU 013644 73-868

19⁹⁹

- 72 Tooth Ratchet with 5 Degree Arc Lets You Work in Tight Spaces
- One Handed Forward and Reverse Action



Screwdriver Set

28 Piece Speed Driver Screwdriver Set

SKU 013649 70-000

29⁹⁹

STORE STOCK

- 6 Times Faster Than Standard Hand Screwdrivers
- The Double Drive Gear Mechanism Allows Continuous Rotation in Forward or Reverse without Ever Lifting Your Hand
- Comes with 28 Piece Bit Set with Multiple Sizes for Most Applications



Bit Sets

9 Piece XZN Triple Square Bit Set

SKU 013563 70-070

24⁹⁹

STORE STOCK

- These Hard to Find Bits are for Tightening and Loosening Head Bolts, Brake Caliper Bolts, Door Handles, Screws, Axle Bolts, and Other Applications Found on Many European Vehicles.
- Includes 1/4", 3/8" and 1/2" Drives
- 1/2" Drives are Tamper Proof



11 Piece 5-Lobe Tamper-Proof Star Plus Bit Set

SKU 013553 70-071

24⁹⁹

STORE STOCK

- These Hard to Find Bits are for Tightening and Loosening Electrical Sensors, Interior, Dash, Body and Trim Pieces Along with Other Applications Found on Many European Vehicles
- Includes 1/4", 3/8" and 1/2" Drives
- S2 Steel



Ratcheting Wrench Sets

7 Piece Slip Resistant Ratcheting Wrench Set

SKU 607062 (Metric) 70-023

51⁹⁹

STORE STOCK

- Metric: 8, 10, 12, 13, 14, 15 and 18 mm

SKU 607063 (SAE) 70-024

49⁹⁹

STORE STOCK

- SAE: 5/16", 3/8", 7/16", 1/2", 9/16", 5/8" and 3/4"

Ratcheting Wrenches are Precision Engineered with 5° Swing Arc Action to Get Into the Tightest Spots.



4 Piece Double Offset Ratcheting Wrench Set

SKU 561039 SAE 70-015

59⁹⁹

- SAE: 5/16" x 3/8", 7/16" x 1/2", 9/16" x 5/8" and 11/16" x 3/4"

*While Supplies Last



2 Piece Double Duty Wrench Set

SKU 951644 (Metric) 70-008

29⁹⁹

STORE STOCK

- Metric: 8, 10, 12, 13, 14, 17, 18 and 19 mm
- SAE: 5/16", 3/8", 7/16", 1/2", 9/16", 5/8", 11/16" and 3/4"

8 Wrenches for the Price of 2

SKU 951643 (SAE) 70-009

29⁹⁹

STORE STOCK



Screwdriver Set

20 Piece Screwdriver Set

SKU 363800 70-204

24⁹⁹

Set Includes:

- Slotted: 3/32" x 2", 1/8" x 2-1/2", 3/16" x 4", 1/4" x 4", 1/4" x 6", 1/4" x 1-1/2", Offset Screwdriver
- Phillips: #00 x 1-1/2", #0 x 2-1/2", #1 x 3", #2 x 4", #2 x 6", #2 x 1-1/2"; Star: #15, #20, #2 Square Plus 4 Piece Hook and Pick Set
- Acetate Handles

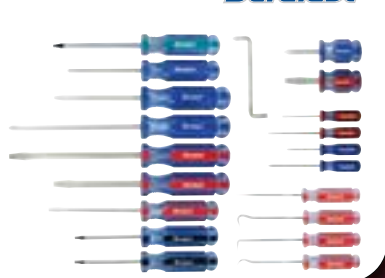

Duralast

Adapters

1/4" M x 3/8" F Adapter SKU 482536 73-814 **4⁹⁹**

3/8" M x 1/4" F Adapter SKU 557436 73-816 **4⁹⁹**

3/8" M x 1/2" F Adapter SKU 482534 73-812 **6⁹⁹**

1/2" M x 3/8" F Adapter SKU 482535 73-813 **4⁹⁹**

3/4" M x 1/2" F Adapter SKU 560449 73-413 **5⁹⁹**

All Open Stock Items Available in Store



Spark Plug Sockets

5/8" x 6" Magnetic Spark Plug Extension

SKU 454330 75-499

12⁹⁹

- Chrome Vanadium for Strength
- Fully Polished to Resist Rust
- 3/8" Drive
- Color Coded Blue - SAE

STORE STOCK



9/16" x 6" Magnetic Spark Plug Extension

SKU 454328 75-498

14⁹⁹

- Chrome Vanadium for Strength
- Fully Polished to Resist Rust
- 3/8" Drive
- Color Coded Blue - SAE

STORE STOCK



Flare Nut Wrenches

Flare Nut Wrench Set (SAE)

SKU 914117 70-026

15⁹⁹

STORE STOCK

- SAE: 3/8" x 7/16", 1/2" x 9/16" and 5/8" x 11/16"



Flare Nut Wrench Set (Metric)

SKU 914115 70-025

17⁹⁹

STORE STOCK

- Metric: 10 x 12 mm, 13 x 14 mm and 15 x 17 mm

Pliers



Slip Joint Pliers

6" Slip Joint SKU 482480 77-016 **6⁹⁹**

8" Slip Joint SKU 482481 77-018 **6⁹⁹**

6.5" Diagonal SKU 482485 77-206 **7⁹⁹**

7.5" Diagonal SKU 482486 77-207 **9⁹⁹**

8" Linesman SKU 482487 77-308 **17⁹⁹**

6.5" Long Nose SKU 482483 77-106 **7⁹⁹**

8" Long Nose SKU 482484 77-108 **8⁹⁹**

All Open Stock Items Available in Store

Sawtooth Jaw Parrot Nose Locking Pliers

SKU 013647 77-513 **19⁹⁹**

Groove Joint Pliers

6" Groove Joint SKU 482488 77-406 **8⁹⁹**

8" Groove Joint SKU 482490 77-408 **11⁹⁹**

10" Groove Joint SKU 482491 77-410 **13⁹⁹**

12" Groove Joint SKU 482492 77-412 **14⁹⁹**

16" Groove Joint SKU 914072 77-416 **27⁹⁹**

Long Nose and Curve Jaw Locking Pliers

4" Curve Jaw SKU 600989 77-504 **9⁹⁹**

5" Curve Jaw SKU 482494 77-505 **9⁹⁹**

6.5" Long Nose SKU 482495 77-506 **11⁹⁹**

7" Curve Jaw SKU 482496 77-507 **12⁹⁹**

9" Long Nose SKU 600990 77-509 **14⁹⁹**

10" Curve Jaw SKU 482498 77-510 **14⁹⁹**

19" Chain Locking SKU 600991 77-519 **21⁹⁹**

Wrenches

Wrenches are Forged with Longer Shanks for Extra Leverage.

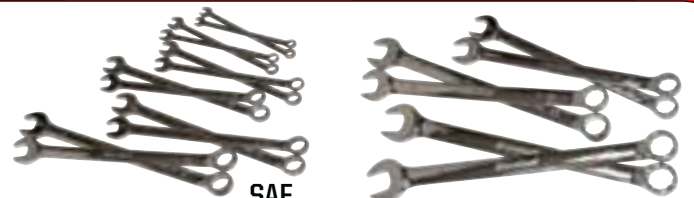

Metric

7 mm Combo Wrench SKU 482606 79-007 **6⁹⁹**

8 mm Combo Wrench SKU 482607 79-008 **6⁹⁹**

9 mm Combo Wrench SKU 482608 79-009 **7⁹⁹**

10 mm Combo Wrench SKU 482609 79-010 **7⁹⁹**

11 mm Combo Wrench SKU 482610 79-011 **7⁹⁹**

12 mm Combo Wrench SKU 482611 79-012 **7⁹⁹**

13 mm Combo Wrench SKU 482612 79-013 **7⁹⁹**

14 mm Combo Wrench SKU 482613 79-014 **8⁹⁹**

15 mm Combo Wrench SKU 482614 79-015 **8⁹⁹**

16 mm Combo Wrench SKU 482615 79-016 **8⁹⁹**

17 mm Combo Wrench SKU 482616 79-017 **8⁹⁹**

18 mm Combo Wrench SKU 482617 79-018 **9⁹⁹**

19 mm Combo Wrench SKU 482618 79-019 **9⁹⁹**

20 mm Combo Wrench SKU 482619 79-020 **10⁹⁹**

21 mm Combo Wrench SKU 482620 79-021 **10⁹⁹**

22 mm Combo Wrench SKU 482621 79-022 **10⁹⁹**

23 mm Combo Wrench SKU 482622 79-023 **12⁹⁹**

24 mm Combo Wrench SKU 482623 79-024 **12⁹⁹**

SAE

1/4" Combo Wrench SKU 482624 79-100 **6⁹⁹**

5/16" Combo Wrench SKU 482625 79-101 **6⁹⁹**

3/8" Combo Wrench SKU 482626 79-102 **6⁹⁹**

7/16" Combo Wrench SKU 482627 79-103 **6⁹⁹**

1/2" Combo Wrench SKU 482628 79-104 **6⁹⁹**

9/16" Combo Wrench SKU 482629 79-105 **6⁹⁹**

5/8" Combo Wrench SKU 482630 79-106 **6⁹⁹**

11/16" Combo Wrench SKU 482631 79-107 **8⁹⁹**

3/4" Combo Wrench SKU 482632 79-108 **8⁹⁹**

13/16" Combo Wrench SKU 482633 79-109 **9⁹⁹**

7/8" Combo Wrench SKU 482634 79-110 **9⁹⁹**

15/16" Combo Wrench SKU 482635 79-111 **11⁹⁹**

1" Combo Wrench SKU 482636 79-112 **13⁹⁹**

1-1/16" Combo Wrench SKU 482637 79-113 **14⁹⁹**

1-1/8" Combo Wrench SKU 482638 79-114 **15⁹⁹**

1-1/4" Combo Wrench

CONTOUR TOOL BOX

OEM TOOLS®



41" 10 Drawer Contour Chest and Cabinet Combo

899⁹⁹ REG. \$999.99

FEATURES

- 10 Drawers With Full Extension 100 Lbs. Capacity Slides for Easy Access
- Patented Raise and Release Drawer Latches to Secure Drawers
- EVA Drawer Liners Included
- 4 Sturdy 5" x 1.5" Tire Style Casters With Wheel Locks
- Gas Struts on Lids for Easy Opening
- One Stainless Steel Handle on Cabinet
- Double Drawer Slides on Larger Drawers
- Dimensions: 41" x 18" x 60.4" (W x D x H)



Race Blue With White Stripes
SKU OUTSIDE BUY/EPO | 24590



Orange With White Stripes
SKU OUTSIDE BUY/EPO | 24620



Green and Matte Black
SKU OUTSIDE BUY/EPO | 24623

Available via Outside Buy/EPO, Call 1-877-298-6651 for ordering instructions.

Lift Gate Service
SKU 295540
OEMLIFTGATE **80⁰⁰**

Offers Good Thru June 30, 2017 - While Supplies Last

HAND TOOLS

OEM TOOLS

JUMBO WRENCHES

JUMBO WRENCHES ARE MADE OF HIGH QUALITY DROP FORGED STEEL AND ARE PRECISION MACHINED TO PREVENT FASTENER DAMAGE.



Box End Offset 15 Degrees for Work in Tight Spaces



Works on Both 6 Point and 12 Point Fasteners

Continuous Curve Design Reduces Spreading, Slippage, and Fastener Damage



Sets Include Heavy Duty Vinyl Roll-Up Storage Bag

SAVE \$15

8 Piece Jumbo Wrench Set (Metric)

SKU 338852 22120

84⁹⁹

REG. \$99.99

Includes Sizes: 21 mm, 22 mm, 24 mm, 25 mm, 27 mm, 29 mm, 30 mm, 32 mm



SAVE \$10

6 Piece Jumbo Wrench Set (SAE)

SKU 338830 22100

69⁹⁹

REG. \$79.99

Includes Sizes: 1-1/16", 1-1/8", 1-1/4", 1-5/16", 1-3/8", 1-7/16"



SAVE \$10

5 Piece Jumbo XL Wrench Set (SAE)

SKU 338833 22101

79⁹⁹

REG. \$89.99

Includes Sizes: 1-1/2", 1-5/8", 1-3/4", 1-7/8", 2"



Individual Sizes Available via Outside Buy/EPO.

Call 1-877-298-6651 for ordering instructions.

Offers Good Through June 30, 2017 While Supplies Last

Combination Wrenches

Combination Wrench Set

- Off Corner Loading for Greater Torque with More Socket-to-Fastener Contact
- Marked on All Four Sides with Standard and Metric Sizes for Easy Identification
- Longer Shaft for Extra Leverage
- The Beam Isn't Too Skinny But Isn't Awkwardly Thick, It's Just About Perfect
- The Flat Profile is Comfortable in Hands
- Exceed ANSI Standards

- 12 Point End Design Which Allows 15° Backward Movement to Re-Engage Fastener
- Smooth Open End Won't Mark Fasteners or Make Sounds When Applying to the Fastener

9 Piece (SAE)

SKU 127906 22996 **99⁹⁹**

Set Includes: 5/16", 3/8", 7/16", 1/2", 9/16", 5/8", 11/16", 3/4", 13/16"

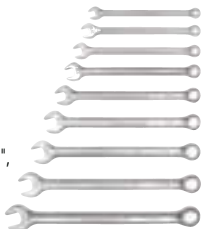

10 Piece (Metric)

SKU 127920 22995 **154⁹⁹**

Set Includes: 10, 11, 12, 13, 14, 15, 16, 17, 18, 19 mm

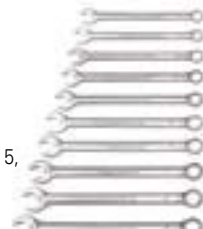

Hard Chrome™ Finish is Satiny, Sexy, and Won't Show Prints

Combo Wrenches Grab Like Mad!

Combo Wrench Set in EVA Foam Tray

- EVA Trays are Designed to Fit Securely in a Cabinet or Tool Box
- Custom Cut of the Tool is a Hi-Vis Green, Making it Visible if a Tool is Missing
- Made with Unique Alloy Steel That is Heat-Treated for Extra Strength and Longevity
- Features a Hard Chrome™ Finish Which Has a Smooth, Satin Finish That Won't Show Prints and Protects Against Rust
- Posi-Grip No-Slip® Design

14 Piece (SAE)

SKU 802222 23993 **149⁹⁹** REG. \$179.99

Set Includes: 1/4", 5/16", 3/8", 7/16", 1/2", 9/16", 5/8", 11/16", 3/4", 7/8", 15/16", 1", 1-1/16" and 1-1/8"

16 Piece (Metric)

SKU 802224 23994 **149⁹⁹** REG. \$179.99

Set Includes: 6, 7, 8, 9, 10, 11, 12, 13, 14, 15, 16, 17, 18, 19, 21 and 22 mm



SAVE \$30

Turning Power Open End Has a 15° Offset So You Can Flip It Quickly For a Better Grip

SAVE \$30

Offers Good Through June 30, 2017 While Supplies Last

Combination Wrench Set

- Posi-Grip No-Slip® Configuration to Achieve Maximum Torque without Damaging Fasteners
- Chrome Over Nickel Plating
- Full Polish Finish

9 Piece (SAE)

SKU 391168 25235 **39⁹⁹**

Set Includes: 3/8", 7/16", 1/2", 9/16", 5/8", 11/16", 3/4", 13/16" and 7/8"

OEM TOOLS



10 Piece (Metric)

SKU 391169 25236 **39⁹⁹**

Set Includes: 10, 11, 12, 13, 14, 15, 16, 17, 18, and 19 mm



Features Posi-Grip No-Slip® Configuration to Achieve Maximum Torque Without Damaging Fasteners

Ratcheting Wrenches

RingStop® Reversible Ratcheting Wrench Set in EVA Foam Tray

- Patented RingStop Design Makes One-Hand Use Easy
- Posi-Grip No-Slip® Design
- Jaw is 15° Offset
- Made with Chrome Vanadium Steel



RingStop Has a Patented Ring on the Box End to Stop the Spanner from Slipping Past the Fastener

Offers Good Through June 30, 2017 While Supplies Last

8 Piece Set (SAE)

SKU 803139 23989 **159⁹⁹** REG. \$199.99

Set Includes: 5/16", 3/8", 7/16", 1/2", 9/16", 5/8", 11/16" and 3/4"



SAVE \$40

BONUS VALUE: \$19.99

8 Piece Go Thru Socket Set (SAE) SKU 807946 | Part# 22979



12 Piece Set (Metric)

SKU 803140 23988 **184⁹⁹** REG. \$249.99

Set Includes: 8, 9, 10, 11, 12, 13, 14, 15, 16, 17, 18 and 19 mm



OEM TOOLS

SAVE \$65

BONUS VALUE: \$29.99

12 Piece Go Thru Socket Set (Metric) SKU 807945 | Part# 22978



8 Piece Go-Thru Socket Set (SAE)

SKU 807946 22979 **19⁹⁹**

Set Includes: 5/16", 3/8", 7/16", 1/2", 9/16", 5/8", 11/16" and 3/4"



12 Piece Go Thru Socket Set (Metric)

SKU 807945 22978 **29⁹⁹**

Set Includes: 8, 9, 10, 11, 12, 13, 14, 15, 16, 17, 18 and 19 mm



EVA Trays Feature a Custom Cut Contrast Soft Foam to Keep Your Tools Organized

Specialty Ratcheting Wrenches

OEM TOOLS

8" Ratcheting Adjustable Wrench

SKU 255655 22658 **24⁹⁹**

- Patented 8" Self-Ratcheting Function Allows for Fast Reversing
- Spring-Loaded Ratcheting Mechanism Releases Tension on One of the Jaws
- High Torque Exceeds ASME Breaking Test Standards
- Easy On/Off Switch Allows Wrench to Be Used with Self-Ratcheting Function or as Standard Wrench
- Ideal for Limited Space and Hard to Reach Areas
- Matte Chrome Finish Resists Rust



2 x 8 Ratcheting Wrench Set

SKU 802209 22062 **24⁹⁹** REG. \$29.99

- 72+ Teeth
- Patented Design
- SAE & Metric Sizes
- 16 Sizes in 2 Tools
- Small: 8 mm x 5/16", 10 mm x 3/8", 12 mm x 7/16" and 13 mm x 1/2"
- Large: 14 mm x 9/16", 16 mm x 5/8", 17 mm x 11/16" and 19 mm x 3/4"
- Hard Chrome™ Finish Has Satin Sheen, Won't Show Prints, and is Easy to Clean

Fits 16 Sizes in 2 Tools

SAVE \$5

Offer Good Through June 30, 2017 - While Supplies Last

Flare Nut Ratcheting Wrench Sets

SKU 432074 22060 **99⁹⁹**

3/8" x 7/16", 1/2" x 9/16", 5/8" x 11/16"

SKU 432076 22061 **99⁹⁹**

Set Includes: 10 x 12 mm, 13 x 14 mm, 15 x 17 mm



OEM TOOLS

Ratcheting System and Flexhead Tilts Up to 180 Degrees at Any Interval to Allow for Access into Tight Spaces

Specialty Wrenches

OEM TOOLS

15" Chain Wrench

SKU 452624 22659 **39⁹⁹**

- Excellent for Objects of Various Sizes
- Designed for Tight Spaces When Ordinary Wrenches Can't Fit
- Double-Action Allows Use in Either Direction
- Chrome Plated to Resist Rust
- Strong I-Beam Handle Construction

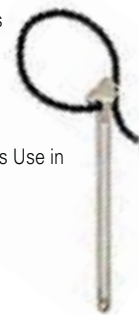

12 Piece Flexible Crowfoot Wrench Set

- Made with Chrome Vanadium Steel for Strength and Durability
- Flexible Head Folds Up to 200 Degrees
- Traditional Flare Nut Wrench and Crowfoot Function
- Ideal for All Hydraulic Fuel, Oil Brake and More

[SAE]

SKU 900810 25519 **49⁹⁹**

Set Includes: 1/4", 5/16", 3/8", 7/16", 1/2", 9/16", 5/8", 11/16", 13/16", 7/8" and 15/16"

[Metric]

SKU 900809 25518 **49⁹⁹**

Set Includes: 8, 9, 10, 11, 12, 13, 14, 15, 16, 17, 18 and 19 mm



90° Swedish Pipe Wrench

SKU 297681 801015 **74⁹⁹**

- Set Includes: 5-1/2" and 7-1/4"
- Jaws with Offset, Induction-Hardened Teeth Bite in Opposite Directions for a Tight Grip
- Ideal Tool for Tie Rods and Alignments
- I-Beam Handle Design for Strength



KNIPEX



Contact Us:
1-877-AZTool1 Phone
 (1-877-298-6651) *Hablamos Español*

Ratchets and Socket Sets

31 Piece 3/8" Drive Mechanic's Set in EVA Foam Tray

SKU 802210
 23998 **119⁹⁹** REG. \$149.99

- Magnetic Spark Plugs
- Featuring 36 Teeth Sealed Head 3/8" Ratchet
- Shallow Sockets, 6-Pt: 8, 9, 10, 11, 12, 13, 14, 15, 16, 17, 18 and 19 mm
- 3/8" Drive Deep Sockets, 6-Pt: 8, 9, 10, 11, 12, 13, 14, 15, 16, 17, 18 and 19 mm
- 3/8" Wobble Extensions: 3", 6" and 12"
- 3/8" Universal Joint
- 3/8" Spark Plugs: 5/8" and 9/16"

Offer Good Through June 30, 2017
 While Supplies Last

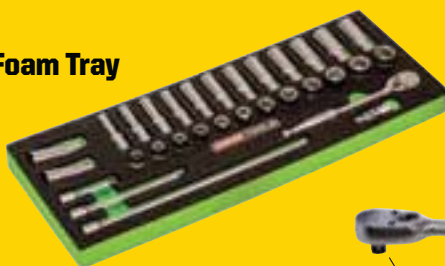

OEM TOOLS

SAVE \$30

Sealed Head Mechanism

Ratchet heads are sealed to keep dirt and debris out. Heads are fully re-buildable and repair parts are available.

26 Piece 1/2" Drive Ratchet and Socket Set

SKU 591154
 23995 **149⁹⁹**

- 26 Pc 1/2" Drive Ratchet and Socket Set
- The Most Popular Tools Used by Mechanics
- Includes: (21) 6 Pt. Metric and SAE Sockets; (1) 1/2" Drive Extension Bar 3"; (1) 1/2" Drive Extension Bar L6; (1) 1/2" Swivel U-Joint; (1) 1/2" Drive Regular Ratchet



OEM TOOLS

80 Piece 1/4" Ratchet and Socket Set in EVA Foam Tray

SKU 087605
 23982 **159⁹⁹**

- Features a 90 Tooth Ratchet with 4 Degree Arc to Get Into Tight Spaces
- (10) 1/4" Drive 6-Point SAE Sockets, Sizes 3/16"- 9/16"
- (12) 1/4" Drive 6-Point Metric Sockets, Sizes 5 mm-15 mm
- (10) 1/4" Deep Drive 6-Point SAE Sockets, Sizes 3/16"- 9/16"
- (12) 1/4" Deep Drive 6-Point Metric Sockets, Sizes 5 mm-15 mm
- Drive Extension Bar
- Drive Universal Joint
- 32 Piece Bit Set with 72-Tooth 1/4" Mini Ratchet
- Comes in Sturdy Blow Molded Case and Tools are Set in a Removable EVA Tray for Easy Identification and Organization



OEM TOOLS

TOOL OF THE MONTH
APRIL
 SEE INSERT FOR DETAILS

64 Piece 1/4" Drive Mechanic's Set in EVA Foam Tray

SKU 020788
 23997 **159⁹⁹** REG. \$199.99

- Shallow Sockets, 6 Pt: 4, 4.5, 5, 5.5, 6, 7, 8, 9, 10, 11, 12, 13, 14 and 15 mm
- 1/4" Drive Deep Sockets, 6 Pt: 4, 4.5, 5, 5.5, 6, 7, 8, 9, 10, 11, 12, 13, 14 and 15 mm
- 1/4" Drive Wobble Straight Extension
- 1/4" x 1/4" Extension
- Bit Extension Bars: 6" and 10"
- Ratchet Screwdriver
- 28 Bits: Square: 1, 2, 3; Slotted: 6-8, 8-10, 10-12, 1/4; Phillips: #1, #1, #2, #2, #2, #2, #3; Torx: T8, T10, T15, T20, T25, T27, T30; Torx Tamper: TT8, TT10, TT15, TT20, TT25, TT27, TT30
- 1/4" Drive Universal Joint
- 1/4" Drive Ratchet

Each Tool Size is Marked for Fast Identification

OEM TOOLS

SAVE \$40



EVA Trays
 Feature a Hard Top Carbon Fiber Style Finish That Makes for a Lifelong Lasting Tray

21 Piece 3/4" Drive Ratchet and Socket Set

SKU 237647
 SSH21 **199⁹⁹**

- Set Includes: 3/4" Drive Ratchet, Breaker Bar, 4" and 8" Extensions
- Standard SAE Sockets: 7/8", 15/16", 1", 1-1/16", 1-1/8", 1-3/16", 1-1/4", 1-5/16", 1-3/8", 1-7/16", 1-1/2", 1-5/8", 1-3/4", 1-13/16", 1-7/8" and 2"



GreatNeck

Ratchets

360° Swivel Ratchets

- 72 Teeth Driving System
- Flexible Rotating Ratchet Head
- Quick Release Button

3/8" Drive

SKU 095065
 28098 **24⁹⁹**
 (While Supplies Last)

1/2" Drive

SKU 095066
 38098 **29⁹⁹**

Swivels



GreatNeck

Socket Sets

10 Piece 1/4" Deep Socket Set in EVA Tray (SAE)

SKU 850056
 23985 **39⁹⁹** Reg. \$44.99

- Includes Sizes: 3/16", 7/32", 1/4", 9/32", 5/16", 11/32", 3/8", 7/16", 1/2" and 9/16"

SAVE \$5



Knurled Base for Firmer Grip

Chamfered Ends
 Chamfered ends on bits and sockets make fastener engagement quick and smooth

OEM TOOLS

12 Piece 1/4" Deep Socket Set in EVA Tray (Metric)

SKU 850510
 23986 **39⁹⁹** Reg. \$44.99

- Includes Sizes: 5, 5.5, 6, 7, 8, 9, 10, 11, 12, 13, 14 and 15 mm

SAVE \$5



Offers Good Through June 30, 2017 While Supplies Last

Screwdriver Sets

20 Piece Screwdriver Set

SKU 363800
 70-204 **24⁹⁹**

- Acetate Handle
- Set Includes: Slotted: 3/32" x 2", 1/8" x 2-1/2", 3/16" x 4", 1/4" x 4", 1/4" x 6", 1/4" x 1-1/2" and Offset Screwdriver; Phillips: #00 x 1-1/2", #0 x 2-1/2", #1 x 3", #2 x 4", #2 x 6", #2 x 1-1/2"; Star: #15 and #20; Square: #2; and 4 Piece Hook and Pick Set



Duralast

37 Piece Ratcheting Screwdriver Set

SKU 094661
 25943 **49⁹⁹**

- Comes in a Sturdy Blow Mold Case
- Includes: Ratcheting Screwdriver Handle
- 17 S2 Steel Bits: Phillips #1, #2, #3; Hex: 5/32", 3/16", 7/32", 5/16"; Slotted: 5/32", 3/16", 7/32", 1/4"; Star: T10, T20, T25, T27, T30, T40
- 1/4" Socket Adapter
- 15 1/4" Sockets: SAE 7/32", 1/4", 9/32", 5/16", 11/32", 3/8", 7/16", 15/32"; Metric 5, 6, 7, 8, 10, 12, 14 mm
- 6" Magnetic Bit Shaft



OEM TOOLS

22 Piece Stubby Ratcheting Screwdriver Set

SKU 094659
 25942 **29⁹⁹**

- 45 Tooth Ratcheting Mechanism for Smooth Ratcheting Stroke
- 3 Locking Positions
- Includes: Slotted: 4", 5", 5-1/2", 6-1/2"; Phillips: #1, #2, #3; Star: T10, T15, T20, T25, T27, T30, T40; Poz: POZ1, POZ2



OEM TOOLS

8 Piece Mechanic's Screwdriver Set in EVA Foam Tray

SKU 802208
 23999 **79⁹⁹**

- Slotted: 1/4" x 1-1/2", 3/16" x 3", 1/4" x 4", 5/16" x 6" and 3/8" x 8"
- Phillips: #2 x 1.5", #1 x 3" and #2 x 4"



Black Magnetic Tip

Hex Bolster
 Hex shaped bolster for when you need more turning power

Unique Ergonomic Handle
 3 sided handle feels good in your hands

Master Sets

OEM TOOLS

121 Piece Mechanic's Tool Set

SKU 850892
 23984 **299⁹⁹**

Multi-Drive Set
 1/4" and 3/8"

- Set Comes in a Heavy Duty Blow Mold Case to Keep Tools Organized
- Includes: Combo Wrenches; 1/4" and 3/8" Drive Sockets; Extension Bars and Ratchets; Long Nose, Diagonal, and Groove Joint Pliers, Reducing Adapters; Ratcheting Screwdriver with 6" Bit Driver Blade; 33 Piece Chrome Plated Bit Set; SAE and Metric Hex Key Sets and More.

Features: POSI-GRIP NO-SLIP® Socket Off Corner Loading for Greater Torque with More Socket-to-Fastener Contact

Ratcheting Screwdriver with 45 Tooth Ratcheting Mechanism and 3 Locking Positions for Smooth Strokes

SEALED RATCHETS to Keep Out Dirt and Debris
 HARD CHROME FINISH Smooth Satin Finish is Easy to Clean, Won't Show Prints and Keeps Rust Away

PRECISION MACHINED JAWS
 Precise Gripping and Maximum Strength

Extensions

10" Quick Extension

1/4" Drive
 SKU 965842
 18096 **14⁹⁹**

3/8" Drive

SKU 965843
 28096 **15⁹⁹**

Extra Long 3 Piece 3/8" Drive Extension Set

SKU 094813
 68034 **29⁹⁹**

- Includes: 18", 24" and 30" Extensions

1/4" Drive 11" Extension BBar

SKU 013586
 71-404 **7⁹⁹**

STORE STOCK

- High Quality, Heat-Treated Alloy Steel for Strength and Durability
- Full Polished Chrome Plating for Easy Clean Up and Corrosion Resistance
- Knurled for Finger Tip Control

Socket Adapters

3 Piece Low Profile Adapter Set

SKU 818570
 22535 **19⁹⁹**

- CR-V Steel for Strength
- Chrome Finish to Resist Rust
- Get into Tighter Spaces
- Includes Sizes: 1/4" F x 3/8" M, 3/8" F x 1/2" M and 1/2" F x 3/4" M

4 Piece Swivel Adapter Set

SKU 191043
 24270 **39⁹⁹**

- Includes Sizes: 1/4" M x 3/8" F, 3/8" M x 1/4" F, 1/2" M x 3/8" F, 3/8" M x 1/2" F
- Pinless Design Enhances Strength and Life

OEM TOOLS

Swivel Provides Constant Torque

HAND TOOLS

Dead Blow Hammers

Professional Grade Quality

- One Piece, Hot Cast Polyurethane Construction
- Safety Red
- Maximum Dead Blow Non-Bounce Action
- Textured, Non-Slip, Comfort Contoured Handle



Dead Blow Hammers

Dead Blow Ball Peen

Dead Blow Sledge Hammers

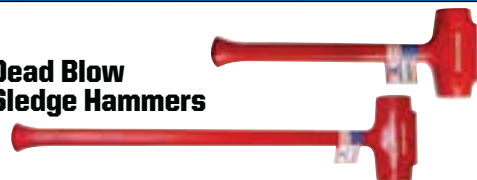

SKU	Part #	Retail Name	Weight	Face Diameter	Head Length	Overall Length	Price
420347	TCH26BP	Ball Peen - 26	26 Oz.	1"	4.1875"	12.75"	39⁹⁹
420349	TCH36BP	Ball Peen - 36	36 Oz.	1.25"	4.5"	13"	44⁹⁹
420351	TCH47BP	Ball Peen - 47	47 Oz.	1.75"	4.8125"	13.625"	49⁹⁹
420352	TCH50BP	Ball Peen - 50	50 Oz.	1.75"	4.8125"	16.5"	59⁹⁹
420353	TCH7	Soft Face Sledge - 7	5.5 Lbs.	2.75"	7"	20"	59⁹⁹
420354	TCH14	Soft Face Sledge - 14	12 Lbs.	3.25"	8"	36"	129⁹⁹
420343	TCH1	Soft Face Hammer - 1	21 Oz.	1.75"	3.75"	11.25"	19⁹⁹
420344	TCH2	Soft Face Hammer - 2	26 Oz.	2"	4.125"	12.75"	24⁹⁹
420345	TCH3	Soft Face Hammer - 3	45 Oz.	2.25"	4.625"	14.375"	29⁹⁹
420346	TCH4	Soft Face Hammer - 4	53 Oz.	2.75"	5.375"	15.25"	44⁹⁹

3 Piece Dead Blow Hammer Set

SKU 900804
25517 **19⁹⁹** Reg. \$26.99

- 1/2 Lb., 1 Lb. and 2 Lbs.
- Soft Rubber Handles for Non-Slip Grip
- Steel Shot Filled for More Force
- Non-Spark Material Used



SAVE \$7

Offer Good Through June 30, 2017 - While Supplies Last

Breaker Bars



1/2" Drive 18" Breaker Bar

SKU 914045
72-123 **12⁹⁹** STORE STOCK

- Ball Retainer
- Flex Drive



1/2" Drive 24" Breaker Bar

SKU 914046
72-121 **21⁹⁹** STORE STOCK

- 24" for Maximum Torque



3/4" Drive 39" Breaker Bar

SKU 989265
BB40 **49⁹⁹**

- 39" for Maximum Torque



Drive Bits

Compact Bit Driver Set

SKU 447158
25945 **16⁹⁹**

- Includes: Phillips, 1, 2, 3; Slotted 3/16", 1/4", 5/16"; T15, T20, T25 and T30 with Magnetic Extension
- Ergonomic Case Converts to Driver and Stores All Components



Stubby Star Drive Sets

- 3/4" Overall Length Designed for Limited Access Applications
- S2 Steel for Strength and Durability

SAVE \$5 each

13 Piece 1/4" Drive

SKU 447157
24293 **24⁹⁹** Reg. \$29.99

- Sizes: T7-T50

Tamper-Proof 13 Piece 1/4" Drive

SKU 447156
24294 **29⁹⁹** Reg. \$34.99

- Sizes: T7-T50

Offers Good Through June 30, 2017 - While Supplies Last



9 Piece Triple Square Bit Set

SKU 191052
25953 **31⁹⁹**

- Set Includes:
 - 1/4" Drive: M4, M5 and M6
 - 3/8" Drive: M8, M10 and M12
 - 1/2" Drive/Tamper-Proof: M14, M16 and M18
 - S2 Steel Bits with Chrome Vanadium Socket



10 Piece External Torx Socket Set

SKU 347214
22974 **39⁹⁹**

- Set Includes: 1/4" Drive: E4, E5, E6, E7
- 3/8" Drive: E8, E10, E11, E12, E14 and E16



9 Piece Hex Bit Set (Metric)

SKU 127903
22983 **37⁹⁹**

- Set Includes: (1/4" Dr.) 2, 2.5, 3, 4mm (3/8" Dr.) 5, 6, 7, 8, 10mm"



7 Piece Hex Bit Set (Metric)

SKU 127883
22981 **48⁹⁹**

- Set Includes: (3/8" Dr.) 6, 8, 10 mm, (1/2" Dr.) 12, 14, 17, 19 mm
- Made with S2 Steel Bits
- Knurling Position is Optimized for Best Finger Gripping Position
- Silver with Crosshatch Marking Indicates Metric Sizes
- Chamfered Ends Allow the Socket to Easily Slip Over the Bolt Head (Makes Fastener Engagement Quick and Smooth)



7 Piece Hex Bit Set (SAE)

SKU 127904
22982 **59⁹⁹**

- Set Includes: (3/8" Dr.) 5/16", 3/8", (1/2" Dr.) 7/16", 1/2", 9/16", 5/8", 3/4"
- Made with S2 Steel Bits
- Knurling Position is Optimized for Best Finger Gripping Position
- Blue with Straight Knurling Indicates SAE Sizes
- Chamfered Ends Allow the Socket to Easily Slip Over the Bolt Head (Makes Fastener Engagement Quick and Smooth)



12 Piece Hex Bit Set (SAE)

SKU 127905
22984 **37⁹⁹**

- Set Includes: (1/4" Dr.) 1/16", 5/64", 3/32", 7/64", 1/8" (3/8" Dr.) 9/64", 5/32", 3/16", 7/32", 1/4", 5/16", 3/8"
- Knurling Position is Optimized for Best Finger Gripping Position
- Go Ahead and Put On Serious Torque, it Won't Slip
- Blue with straight knurling indicates SAE sizes



S2

35 Piece Multi-Drive Star Socket Set in EVA Foam Tray

SKU 802217
23991 **44⁹⁹**

- 1/4" Drive Star: T10, T15, T20, T25, T27 and T30
- 1/4" Drive Tamper-Proof Star: T7, T8, T9, T10, T15, T20, T25 and T30
- 1/4" Drive Female Star: E4, E5, E6, E7 and E8
- 3/8" Drive Star: T40, T45, T47, T50 and T55
- 3/8" Drive Tamper-Proof Star: T40, T45, T50 and T55
- 3/8" Drive Female Star: E10, E12, E14 and E16
- 1/2" Drive Star: T60 and T70
- 1/2" Drive Female Star: E18



EVA Trays
Features a Hard Top Carbon Fiber Style Finish That Makes for a Life Long Lasting Tray.

44 Piece Multi-Drive Star Socket Set in EVA Foam Tray

SKU 802206
23992 **44⁹⁹** Reg. \$49.99

- 1/4" Bit Holder
- 1/4" Hex Drive Tamper-Proof Star Bits: T7, T8, T9, T10, T15, T20, T25, T27 and T30
- 1/4" Drive Star: T10, T15, T20, T25, T27 and T30
- 3/8" Drive Star: T40, T45, T47, T50, T55 and T60
- 3/8" Drive Metric Hex: 2, 2.5, 3, 4, 5, 6, 7, 8 and 10 mm
- 3/8" Drive SAE Hex: 1/8", 5/32", 3/16", 7/32", 1/4", 5/16" and 3/8"
- 3/8" Drive Phillips: #1, #2 and #3
- 3/8" Drive Slotted: 3/16", 1/4" and 5/16"



SAVE \$5

Offer Good Through June 30, 2017 While Supplies Last

Master Hex Bit Set

SKU 094663
25952 **49⁹⁹**

- 1/4" Drive: 1/8", 5/32", 3/16" and 7/32"
- 3/8" Drive: 1/4", 9/32", 5/16" and 11/32"
- 1/2" Drive: 3/8", 1/2", 9/16", 3/4" and 5/8"
- 1/4" Drive: 2.5, 3, 4 and 5 mm
- 3/8" Drive: 6, 7, 8 and 9 mm
- 1/2" Drive: 10, 12, 14, 17 and 19 mm
- Comes in a Blow Mold Case



S2

11 Piece Tamper-Proof Torx Plus Bit Socket Set

SKU 255725
22973 **59⁹⁹**

- Set Includes: (1/4" Drive) 8-TPT, 10-TPT, 15-TPT, 20-TPT and 25-TPT
- (3/8" Drive) 27-TPT, 30-TPT, 40-TPT, 45-TPT, 50-TPT and 55-TPT



Tamper-Resistant Star Security Bits

44 Piece Master Torx® and Hex Bit Set

SKU 311698
25950 **46⁹⁹**

- Hex: 2, 2.5, 3, 4, 5, 6, 7, 8, 10; 1/8", 5/32", 3/16", 7/32", 1/4", 5/16" and 3/8"
- Star: T10, T15, T20, T25, T27, T30, T40, T45, T47, T50, T55 and T60
- Phillips: #1, #2 and #3
- Slotted: 3/16", 1/4" and 5/16"
- Bits: T7H, T8H, T9H, T10H, T15H, T20H, T25H, T27H and T30H



35 Piece Master Torx® Bit Set

SKU 466622
25951 **49⁹⁹**

- Star: T8, T10, T15, T20, T25, T27, T30, T40, T45, T47, T50, T55 and T60
- Tamper-Proof Star: T7, T8, T9, T15, T20, T25, T30, T40, T45, T50 and T55
- Female Star: E4, E5, E6, E7, E8, E10, E12, E14, E16 and E18



26 Piece Master Hex Bit Set in EVA Foam Tray

SKU 802219
23990 **69⁹⁹** REG. \$79.99

- 1/4" Drive: 1/8", 5/32", 3/16" and 7/32"
- 3/8" Drive: 1/4", 9/32", 5/16" and 11/32"
- 1/2" Drive: 3/8", 1/2", 9/16", 3/4" and 5/8"
- 1/4" Drive: 2.5, 3, 4 and 5 mm
- 3/8" Drive: 6, 7, 8 and 9 mm
- 1/2" Drive: 10, 12, 14, 17 and 19 mm



Chamfered Ends
Chamfered ends on bits and sockets make fastener engagement quick and smooth

Strength
Made with S2 steel

Control
Knurling position is optimized for finger tip control

Quick ID
Deep markings won't wear off with extended use

Offer Good Through June 30, 2017 While Supplies Last



Contact Us:
1-877-AZTool1 Phone
 (1-877-298-6651) *Hablamos Español*

Pliers

Professional Snap Ring Plier Set

SKU 141502
25356 **16⁹⁹**

- 180°, 90° and 45° in One
- Tip Size: 0.8 mm, 1.2 mm, 1.4 mm, 2.0 mm



OEM TOOLS

3 Piece 16" Long Nose Plier Set

SKU 237648
L113S **19⁹⁹**

- Great for Confined Spaces When You Need an Extra Long Reach
- Set Includes: 45° Pliers, 90° Pliers and Straight Pliers



OEM TOOLS

10 Piece Snap Ring Plier Set

SKU 900819
27180 **61⁹⁹**

- For Both Internal and External Rings
- Set Includes: 5-1/2" Bent Pliers with .038" Tip; 6" Straight Pliers with .038" Tip; 5-1/2" Bent Pliers with .047" Tip; 6" Straight Pliers with .047" Tip; 7-1/2" Bent Pliers with .070" Tip; 8" Straight Pliers with .070" Tip; 8-1/2" Bent Pliers with .090" Tip; 9" Straight Pliers with .090" Tip
- Also Includes Two Stainless Steel Handle Picks



OEM TOOLS

Angle Tip Lock Ring Pliers

SKU 191055
25354 **16⁹⁹**

- Jaws are Scored on the Outside for Secure Gripping
- Spring Loaded Jaws
- Spread: 3/4"
- Length: 8-1/4"



OEM TOOLS

3 Piece, 11" Hose Gripper Plier Set

SKU 094811
L311L **19⁹⁹**

- Extra Long Handle Gets Into Tight Areas
- Includes Sizes: 5/16", 1/2" and 3/4"
- Ideal for Removing Cooling System, Fuel and Vacuum Lines
- Heat-Treated, Ergonomic Comfort Grip Handles



GreatNeck

8 3/4" Ear Clamp Pliers

• Suitable for Simple and Reliable Clamping of 1-Ear and 2-Ear Clamps



KNIPLEX

with Front Jaw

SKU 297701
KNP10981220 **24⁹⁹**

with Front Jaw and Side Jaw

SKU 298005
KNP10991220 **29⁹⁹**

3 Piece Cobra® Pliers Set

SKU 505075
KNP002006US1 **119⁹⁹**

- Comfort Grip, Two-Color Dual Component Handles
- Box-Joint Design is Highly Stable Because of a Double Guide

- Fast Adjustment Directly on the Work Piece
- Pinch Guard Prevents Operator's Fingers from Being Pinched
- Contains Special Hardened Teeth
- Grips Any Shaped Object - Round, Square, Hex or Flat



KNIPLEX

3 Piece Plier Wrench Set

SKU 297686
KNP002006US2 **164⁹⁹**

- Set includes: 7-1/4", 10", 12"
- Functions as Pliers and Wrench All-in-One-Tool
- Smooth Jaws Won't Damage Soft Finishes
- Secure Grip, 10x Your Strength
- Push-Button Adjustment Directly on the Workpiece



KNIPLEX

10" Cobra® Pump Pliers

SKU 297700
KNP8701250 **36⁹⁹**

- Push-button Adjustment Directly on the Workpiece
- Self-locking Means No Slipping off the Workpiece
- Gripping Surface with Special, Hardened Teeth (approximately 61 HRC)
- Grips Any Shaped Object: Round, Square, Hex or Flat
- Thin Head Fits Into Tight Places



KNIPLEX

10" Plier Wrench

SKU 297845
KNP86032500 **61⁹⁹**

- Functions of Pliers and a Wrench All in One Tool
- Smooth Jaws Won't Damage Soft Finishes



KNIPLEX

22" Cobra® Pump Pliers

SKU 297682
KNP8701560 **129⁹⁹**

- Push-Button Adjustment Directly on the Workpiece
- Self-Locking Means No Slipping Off the Workpiece
- Gripping Surface with Special, Hardened Teeth (Approximately 61 HRC)
- Grips Any Shaped Object: Round, Square, Hex or Flat
- 4-1/2" Gripping Capacity

Additional Sizes Available: 5", 6", 7 1/4", 10", 12", and 16"

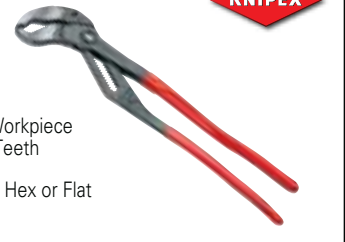

KNIPLEX

Soft Jaw Pipe and Connector Gripping Pliers

SKU 042414
KNP8111250 **74⁹⁹**

- For Siphon Tube Fittings and Connectors Up to 80 mm Diameter
- 25 Adjustment Positions
- Chrome Vanadium Electric Steel
- Exchangeable Plastic Jaws for Sensitive Surfaces



KNIPLEX



EVA Trays
Features a Hard Top Carbon Fiber Style Finish That Makes for a Life Long Lasting Tray.

7 Piece Locking Pliers Set in EVA Tray

SKU 012622
23987 **119⁹⁹**

- Sizes: 4", 5", 7", 10" Curved Jaw and 4", 6", 9" Long Nose



Hex Screw
Patented Square Drive and Hex Control



OEM TOOLS

Bolt Cutters

Bolt Cutters

- Forged S2 Steel Construction for Cutting Power
- Hardened Cutting Edge for Long Life
- Ergonomic Comfort Grip Handles

24" Bolt Cutters
SKU 025213
BC24 **19⁹⁹**

30" Bolt Cutters
SKU 965828
BC30 **24⁹⁹**



GreatNeck

8" Mini Bolt Cutter with Notch

SKU 042478
KNP7131200 **59⁹⁹**

- Cuts Hard Wire, Steel Rods, Fencing and Bolts
- Cutting Edge Hardness 64 HRC
- Recess in Blade for Easier Cutting
- 20-to-1 Compound Joint Ratio = 60% Less Effort is Required During Cutting



KNIPLEX

Cutters

10" High Leverage Diagonal Cutter

SKU 080088
KNP7401250 **49⁹⁹**

- High Leverage Require 21% Less Effort
- Forged Axle-Rivet Joint Ensures Smooth Operation
- Long and Precise Induction-Hardened Cutting Edges (Approximately 64 HRC) for Extra Long Life and Effortless Cutting of Hardened Wire



KNIPLEX

8" Battery Cable Cutter

SKU 080091
KNP9511200 **59⁹⁹**

- For Cutting Copper and Aluminum Cables
- Not Suitable for ACSR, Steel Wire and Hard Drawn Copper Conductors
- Dual Jaws Allow Thicker Cables to Be Stripped and Then Cut in a Two-Step Process



KNIPLEX

2 Piece Flush Cutter Set

SKU 297849
KNP9K008090US **69⁹⁹**

- Set Includes: 5 1/2" and 7 1/4"
- Provides a Fully Flush Cut When Cutting Tie-Wraps, Plastic and Soft Metals
- Spring Assisted Handles for Easier Repetitive Cutting



KNIPLEX

Pry Bars

5/8" x 36" Pry Bar

SKU 695126
24435 **39⁹⁹**

- Unique Ergonomically Designed 3-Sided Handle for Secure Grip and Comfort
- Handles Made with Hardened Resin That is Solvent Resistant and Easy-to-Clean
- Forged and Hardened 5/8" Square Stock for Incredible Strength



OEM TOOLS

Pick-Up Tools

Heavy Duty Telescopic Magnetic Pick-Up Tool

SKU 231205
25466 **7⁹⁹**

STORE STOCK

- Lifts Up to 3 Lbs.
- Telescoping Handle Range 6" to 33" with a Steel J-Hook



3-in-1 Pick-Up Tool Magnet, Claw and LED Light

SKU 110277
25293 **19⁹⁹**

- 24-1/2" Flexible Reach
- 4 Claw Grip for Easy Pick-Up
- Magnetic End with Extra Strong Hold
- Bright LED Lighted Base for Convenience

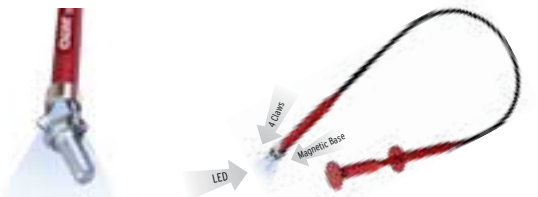

OEM TOOLS

3 Piece Pry Bar Set

SKU 626114
24433 **44⁹⁹**

- Pry Bar Sizes: 3/8" x 12", 7/16" x 18" and 7/16" x 24"
- Unique Ergonomically Designed 3 Sided Handle for Secure Grip and Comfort
- Handles are Solvent Resistant and Easy to Clean
- Comes in a Plastic Tray



OEM TOOLS

Picks

4 Piece 15" Jumbo Pick Set

SKU 094658
25940 **24⁹⁹** Reg. \$29.99

- Includes: Straight, 90°, Offset and Hook Pick
- Chrome Vanadium Steel for Strength and Durability
- Black Oxide Finish to Resist Rusting
- Cushion Grip Handles

Offer Good Through June 30, 2017 - While Supplies Last



OEM TOOLS

SAVE \$5

Punch and Chisel

11 Piece Punch and Chisel Set in EVA Foam Tray

SKU 802227
23996 **59⁹⁹**

- Tapered Punches: 3/32" x 8 mm x 5-1/4", 5/32" x 10 mm x 6", 3/16" x 12 mm x 6-1/4"
- 3 Piece Pin Punches: 3/32" x 8 mm x 4-1/4", 5/32" x 10 mm x 5", 3/16" x 10 mm x 5-1/4"
- Center Punches: 3/16" x 12 mm x 6"
- Cold Chisels: 3/8" x 8 mm x 5-1/2", 1/2" x 10 mm x 6", 5/8" x 12 mm x 6-1/2"
- 1 Gauge



OEM TOOLS

UNIFORMS

View Product Information www.1-stopworkwear.com
To Place an Order Call Your AutoZone Commercial Sales Manager
For Product Information Call 1-855-275-1403

TAKE ADVANTAGE OF THE DICKIES ADVANTAGE

Quality Since 1922, Durable, Comfortable & Great Value



Dickies Auto Tech Work Shirt

- Button Front Shirt; One Snap Closure at Neck
- Mitered Front Pockets with Pencil Division on Left Pocket
- Fade Resistant

(Small to 4XL) 65% Polyester/35% Cotton	Short Sleeve 1SSS535	Long Sleeve 1SL535
Item Only	17 ⁹⁹	19 ⁹⁹
Item + Shop Name	22 ⁹⁹	24 ⁹⁹
Item + Employee Name	24 ⁹⁹	26 ⁹⁹
Item + Shop + Employee Name	29 ⁹⁹	31 ⁹⁹



Dickies Shop Series Collection

Define Your Custom Look

- Shop Name - Embroider the Left Chest of Any Work Shirt. Designate the Item Number, Text and Text Color
- Employee Name - Personalize the Right Chest of Any Work Shirt
- Includes Up to 10 Characters Per Line, 2 Line Limit

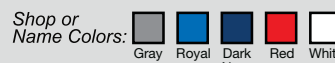

Dickies Color Block Auto Shirt

(S to 5XL)
65% Polyester/
35% Cotton

- Mitered Front Pockets with Pencil Division on Left Pocket
- Fade Resistant
- Industrial Laundry Friendly



(Small to 4XL) 65% polyester/35% cotton	Short Sleeve 1SSS524	Long Sleeve 1LS524
Item Only	29 ⁹⁹	31 ⁹⁹
Item + Shop Name	34 ⁹⁹	36 ⁹⁹
Item + Employee Name	36 ⁹⁹	38 ⁹⁹
Item + Shop + Employee Name	41 ⁹⁹	43 ⁹⁹

Dickies Short Sleeve Work Shirt

(S to 5X)
65% Polyester/
35% Cotton

- Generous Fit in Shoulders and Chest
- 5.25 Oz. Twill
- Resists Wrinkles
- Moisture Wicking for Comfortable Wear
- Square Tail Design Stays Tucked in



NEW



Item Only	29 ⁹⁵
Item + Shop Name	34 ⁹⁵
Item + Employee Name	36 ⁹⁵
Item + Shop + Employee Name	41 ⁹⁵

Dickies Performance Polo

(S to 5XL)
100% Polyester

- Easy Care Stain Release
- Moisture Wicking
- Side Vents
- Snag Resistant

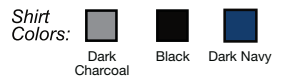

Item Only	26 ⁵⁰
Item + Shop Name	31 ⁵⁰
Item + Employee Name	33 ⁵⁰
Item + Shop + Employee Name	38 ⁵⁰

Dickies Color Block Performance Polo

(S to 5XL)
100% Polyester

- Easy Care Stain Release
- Moisture Wicking
- Side Vents
- Snag Resistant



Item Only	26 ⁵⁰
Item + Shop Name	31 ⁵⁰
Item + Employee Name	33 ⁵⁰
Item + Shop + Employee Name	38 ⁵⁰

Dickies Performance Shop Shirt

(S to 5XL)
65% Polyester/
35% Cotton

- Easy Care Stain Release
- Moisture Wicking
- Resists Wrinkles
- 4.6 Oz Flexwill
- Available in Long Sleeve



Item Only	33 ⁹⁹
Item + Shop Name	38 ⁹⁹
Item + Employee Name	40 ⁹⁹
Item + Shop + Employee Name	45 ⁹⁹

Dickies Performance Tee

(M to 5XL)
85% Polyester/
15% Cotton

- Dri Release, Resists Pulling & Wrinkles
- Resists Stains
- Jersey Knit with Wicking

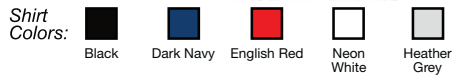

Item Only	25 ⁹⁹
Item + Shop Name	30 ⁹⁹
Item + Employee Name	32 ⁹⁹
Item + Shop + Employee Name	37 ⁹⁹

Dickies WorkTech Ventilated Performance Shirt

(M to 5XL)
65% Polyester/35% Cotton

- Easy Care Stain Release
- Moisture Wicking
- Flex Fabric for Comfort and Mobility
- 4.2 Oz Mechanical Stretch Poplin Side and Back Mesh Panels



Item Only	34 ⁹⁹
Item + Shop Name	39 ⁹⁹
Item + Employee Name	41 ⁹⁹
Item + Shop + Employee Name	46 ⁹⁹

WorkTech Ventilated Polo

(S to 5XL)
100% Polyester

- 6 Oz Micro Pique
- 4.7 Oz Performance Mesh
- Easy Care Stain Release
- Resists Wrinkles, Snags and Fading

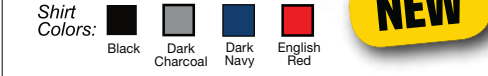

Item Only	29 ⁹⁵
Item + Shop Name	34 ⁹⁵
Item + Employee Name	36 ⁹⁵
Item + Shop + Employee Name	41 ⁹⁵

Dickies Shop Pant

65% Polyester/35% Cotton
Waist: 30-50 Even Sizes Only
Inseam: 28-36

DICKIES 20⁹⁹

- Relaxed Fit
- StayDark Technology
- Wrinkle/Stain Resistant

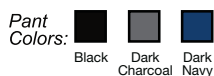

Dickies Blended Coverall

(Small to 4XL)
65% Polyester/35% Cotton

- Durable Poly/Cotton
- Easy Care Stain Release
- Two Large Back Pockets



Item Only	45 ⁴⁵
Item + Shop Name	50 ⁴⁵
Item + Employee Name	52 ⁴⁵
Item + Shop + Employee Name	57 ⁴⁵

Dickies Cargo Pant

65% Polyester/35% Cotton
Waist: 30-50 Even Sizes Only
Inseam: 28-36

1SPCARGO 28⁹⁹

- Relaxed Fit
- StayDark Technology
- Wrinkle/Stain Resistant

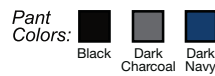

Dickies Performance Shop Pant

65% Polyester/ 35% Cotton
Waist: 30-50 Even Sizes Only
Inseam: 28-36

1SLP605 37⁹⁹

- Rubberized Scratch Resistant Tack Button Closure
- Easy Care Stain Release
- Cell Pocket
- Double Knee
- 7 1/4 Flex Twill



Dickies Cargo Short

65% Polyester/35% Cotton
Waist: 30-50
Even Size Only
Inseam: 11

1SPCSHORT 28⁹⁹

- Relaxed Fit
- StayDark Technology
- Wrinkle/Stain Resistant



All Hats Come With Shop Name That Includes Up to 10 Characters Per Line With 2 Line Limit. Minimum Purchase = 6

Shop Hats - Only \$5⁰⁰!

Black Hat 1SH03

Black Mesh 1SH01



Khaki Hat with Black or Navy Bill 1SH04



Camo Hat 1SH06 8⁵⁰

Checked Racing Hat with Mesh Back 1SH12 11⁷⁵

• Color: Magnet Grey



Specialty Hats - as Low as \$9⁹⁹!



AutoZone Custom Embroidered Hats

- Thread Color Choices: Black, Royal, Navy, Red, White, Orange, Tan, Grey
- Hats Include Up to 10 Characters Per Line, 2 Line Limit
- Minimum Order is Only 6 Pieces!

Item#	Description	Color	Price
WW415PC	Camo Hat with Camo Mesh Back	Mossy Oak	9 ⁹⁹
WWGL-845	Contrasting Sandwich, Buttons & Eyelet	Black/Red or Navy/White	9 ⁹⁹
WWFWT-130	Heavy Garment Washed, Mesh Back	Black/Dark Grey, Charcoal/White or Black/Tan	10 ⁹⁹
WWGWT-111	Unstructured Garment Washed Twill	Black, Charcoal or Navy	12 ⁹⁹
WWHIB-836	OC Hi Beam Mesh Back Hat with Built-In LED Lights	Navy or Black	19 ⁹⁹

PROMOTE YOUR SHOP!

Go to WWW.1-STOPWORKWEAR.COM for product details.

Item#	Description	Price
ISPROS27	Black Click Pen	.90
1SPRO8	Mini Tire Gauge Keychain	1.35
1SPRO7	Metal Key Tag	1.75
AZFLASH	LED Flashlight	4.50
WWBottle	Aluminum Water Bottle	4.50
1SPR11	Matrix Tumbler 18 oz.	7.25
1SPRB07	Cinch Bag with Zipper	13.99



SAFETY SUPPLIES

Safety

Camo LED Glasses

- Adjustable Ultra-Bright Built-In LED Lights
- High-Impact Polycarbonate Lenses
- 99.9% UV Protection
- Anti-Fog & Scratch Resistant Lens Coating
- LR44 Batteries Included
- Meets ANSI Z87.1 – 2015

Green
SKU 010115
SAS5421 **19⁹⁹**



GREEN CAMO



Tan
SKU 010113
SAS5422 **19⁹⁹**



TAN CAMO



NSX Turbo Safety Glasses (Box of 12)

- High Impact Clear Polycarbonate Lens
- 99.9% UV Protection
- Lightweight, Wrap Around Shade Lens

Clear Lens SKU 301767 | SAS5330PK **24⁹⁹**

Yellow Lens SKU 462984 | SAS5332PK **24⁹⁹**

Shade Lens SKU 462983 | SAS5331PK **24⁹⁹**



Nuisance Dust Mask (Box of 50)

SKU 526952
SAS2985 **16⁹⁹**

- One-Size-Fits-All Mask That Reduces Irritating Effects from Non-Toxic Particles



Bandit N95 Half Mask Respirator

SKU 972274
SAS866192 (M) **22⁹⁹**

SKU 972275
SAS866193 (L) **22⁹⁹**

- Form Fitting and Can Be Worn for Hours

While Supplies Last



10 Person First Aid Kit

SKU 000006
SAS6010 **22⁹⁹**

- Multi-Use First Aid Kit Designed for Use in the Workplace for Up to 10 Employees



Foam Ear Plugs (Box of 200)

SKU 526953
SAS6100 **34⁹⁹**

- Noise Reduction Rating: 30



Bottle Eye Wash Station*

SKU 094904
SAS5132 **49⁹⁹**

- Includes (2) 16 Oz. Eye Irrigate Solution Bottles

*Please Verify with OSHA or with a Certified Safety Professional That This Meets OSHA Requirements



16 Oz. Eye Wash Irrigate Refill

SKU 977588
SAS5130 **19⁹⁹**

- For Use with Eye Wash Station SAS5132

16 Gallon Emergency Eye Wash Station

SKU 094905
SAS5135 **199⁹⁹**

- Station Comes with Water Preservative
- One-Hand Operation Gravity-Fed 15 Minute Flow Time
- Change Water Every 90 Days



8 Oz. Eye Wash Preservative Refill

SKU 977586
SAS5136 **16⁹⁹**

- For Use with Eye Wash Station SAS5135
- Portable Water Preservative
- Add One Bottle for Each 15 Gallons of Water

Back Belts

Deluxe Back Support Belt

- Made of Lightweight, Cool, Washable Nylon
- Six Fully Enclosed Steel Springs Stay Flexible for Contoured Support
- Tapered Design Allows a Full Range of Body Motion While Maintaining Proper Support

19⁹⁹

Small

SKU 803153
SAS7161

Medium

SKU 803156
SAS7162

Large

SKU 803161
SAS7163

X-Large

SKU 803151
SAS7164

XX-Large

SKU 803152
SAS7165



Deluxe Hi-Vis Back Support

- Bright Orange and Yellow Design Allows for Extra Visibility
- Made of Lightweight, Cool, Washable Polyester
- Tapered Design Promotes Better Movement for Proper Back Support

24⁹⁹

Small

SKU 803154
SAS7261

Medium

SKU 803157
SAS7262

Large

SKU 803158
SAS7263

X-Large

SKU 803159
SAS7264

XX-Large

SKU 803160
SAS7265



SHOP SUPPLY of the MONTH **MAY** SEE INSERT FOR DETAILS

OEM TOOLS

QUALITY - INNOVATION - VALUE

NEW

3 Pack LED Safety Glasses

SKU 592265
26017PK3 **29⁹⁹**

- High-Impact Polycarbonate Lenses
- Soft Thermoplastic Rubber Arm Ends Provide Added Comfort
- 100% UV Protection
- ANSI Z87.1 Standards
- Hi-Visibility Green for Easy Finding
- Batteries Included
- Pack of 3



MW
MECHANIX WEAR



ORIGINAL COVERT
MG-55

SKU	PART#	DESCRIPTION	PRICE
360452*	MG-55-008	ORIGINAL COVERT GLOVE S	19⁹⁹
360454	MG-55-009	ORIGINAL COVERT GLOVE M	19⁹⁹
360455	MG-55-010	ORIGINAL COVERT GLOVE L	19⁹⁹
360456*	MG-55-011	ORIGINAL COVERT GLOVE XL	19⁹⁹
360457*	MG-55-012	ORIGINAL COVERT GLOVE XXL	19⁹⁹

* Special Order Only

STORE STOCK



ORIGINAL GRIP
MGG-05

SKU	PART#	DESCRIPTION	PRICE
933674*	MGG-05-008	ORIGINAL GRIP GLOVE S	22⁹⁹
933675	MGG-05-009	ORIGINAL GRIP GLOVE M	22⁹⁹
454400	MGG-05-010	ORIGINAL GRIP GLOVE L	22⁹⁹
454403*	MGG-05-011	ORIGINAL GRIP GLOVE XL	22⁹⁹
933676*	MGG-05-012	ORIGINAL GRIP GLOVE XXL	22⁹⁹

* Special Order Only

STORE STOCK



M-PACT
MPT-58

SKU	PART#	DESCRIPTION	PRICE
378916*	MPT-58-008	MPACT GLOVE BLK/GREY S	24⁹⁹
378900	MPT-58-009	MPACT GLOVE BLK/GREY M	24⁹⁹
378901	MPT-58-010	MPACT GLOVE BLK/GREY L	24⁹⁹
378902	MPT-58-011	MPACT GLOVE BLK/GREY XL	24⁹⁹
378910*	MPT-58-012	MPACT GLOVE BLK/GREY XXL	24⁹⁹

* Special Order Only

STORE STOCK

THE TOOL THAT FITS LIKE A GLOVE®

GLOVES



NOTHING'S TOUGHER THAN STEEL™



VENOM STEEL® INDUSTRIAL NITRILE GLOVES

From brakes to body work, tune-ups to transmissions, rip through the filthiest jobs, without ripping through your gloves.

70% THICKER*



19⁹⁹

100 CT BOX

MEDIUM: SKU 847122 VEN6142H
LARGE: SKU 847123 VEN6143H
X-LARGE: SKU 847125 VEN6144H

- Black, 6 mil thick
- Rip, tear & puncture-resistant premium black nitrile
- Fully textured for extra grip
- Powder-free

BEST VALUE 89⁹⁹

Now available in select stores



500 CT BOX

MEDIUM: SKU 847126 VEN6542
LARGE: SKU 847127 VEN6543
X-LARGE: SKU 847128 VEN6544

- Same high quality black nitrile as the 100 count box
- Great savings for auto shops and contractors

*Compared to Venom® Nitrile Gloves.



VENOM STEEL® INDUSTRIAL LATEX GLOVES

Premium, extra thick natural latex for heavy-duty protection with a great sense of touch.

70% THICKER**



19⁹⁹

100 CT BOX

MEDIUM: SKU 847130 VEN8122H
LARGE: SKU 847131 VEN8123H
X-LARGE: SKU 847124 VEN8124H

- Beige, 8 mil thick
- Ultimate flexibility & comfort
- Textured fingers for better grip
- Touch screen sensitive
- Powder-free

**Compared to Venom® Latex Gloves.



©2016 Medline Industries, Inc. All rights reserved. Venom and Venom Steel are registered trademarks and Nothing's Tougher Than Steel is a trademark of Medline Industries, Inc. MKT1679231

DID YOU KNOW?

There are over 120 million vehicles on the road with TPMS and that equates to almost 500 million sensors that will need to be replaced in the coming years.

Contact Your AutoZone® Commercial Sales Manager for Details

Disposable Gloves

Dura Flock® Gloves (50 Gloves Per Box)

SKU 429674 DFK-608-M (M) **19⁹⁹** each

SKU 429676 DFK-608-L (L) **19⁹⁹** each

SKU 429678 DFK-608-XL (XL) **19⁹⁹** each

Select store availability February 2017



MICROFLEX®

Utilizing a super-thin moisture absorbing flock lining, Dura Flock gloves keep hands dry and comfortable. Designed with 25% more thickness than standard disposable gloves, Dura Flock gloves offer increased protection for demanding jobs while reducing muscle fatigue through a comfortable fit.

- 25% thicker than standard disposable gloves
- Longer cuff for increased protection
- Fully textured surface for a great grip
- Overall Length: 10.6"
- 0.20 mil Finger, .21 mil Palm

Product Attributes: Dark Green Color • Nitrile • Non-Sterile • Ambidextrous • Fully Textured • Beaded Cuff • For Single Use Only • Non-Latex • For Non-Medical Use

Diamond Grip™ Gloves (100 Gloves Per Box)

SKU 497065 MF-300-M (M) **17⁹⁹** each

SKU 497064 MF-300-L (L) **17⁹⁹** each

SKU 497066 MF-300-XL (XL) **17⁹⁹** each



MICROFLEX®

The benchmark in strength and durability in latex gloves. Thicker than typical latex gloves, Diamond Grip gloves provide enhanced protection, especially in the fingertips where protection is critical.

- Unique Design Prevents Ripping and Tearing
- Enhanced, Textured Fingertips for Added Protection and Function
- Ideal for Rugged Tasks in Mid to Heavy-Duty Environments
- Overall Length: 9.8"
- 9.1 mil Finger, 6.3 mil Palm
- 21MPa Tensile Strength
- Low Protein Latex (<= 50 Micrograms/g)

Product Attributes: Natural Color • Latex • Non-Sterile • Ambidextrous • Textured Fingertips • Beaded Cuff • For Single Use Only

Ansell



Contact Us:
1-877-AZTool1 Phone
 (1-877-298-6651) *Hablamos Español*

Disposable Gloves

**Value-Touch Latex
 5 mil, Powder Gloves**

- 100 Gloves Per Box - 10 Boxes Per Case
- Strength from a Durable Glove
- Keep Sensitivity and Be Safe on the Job
- Powder-free Latex Exam Grade Gloves
- Beaded Cuffs
- Ambidextrous



1,000 Gloves

Case (10 Boxes, 100 Ea.), **\$12.99** Per Box

- SKU **265076** SAS6592CS (M) **129⁹⁹**
- SKU **265079** SAS6593CS (L) **129⁹⁹**
- SKU **265068** SAS6594CS (XL) **129⁹⁹**

**Professional Black Nitrile
 4.5 mil, Textured Grip**

- 100 Gloves Per Box - 10 Boxes Per Case
- Superior Puncture and Abrasive Resistant
- LatexFree
- Textured Grip
- Beaded Cuff
- Ambidextrous



1,000 Gloves

Case (10 Boxes, 100 Ea.), **\$12.99** Per Box

- SKU **504168** SAS66542CS (M) **129⁹⁹**
- SKU **504169** SAS66543CS (L) **129⁹⁹**
- SKU **504172** SAS66544CS (XL) **129⁹⁹**

**Nitrile Palm Knit Gloves
 (1 Dozen)**

- Liquid Dipped 100% Nitrile Palm Coat
- 16 Gauge Seamless Nylon Shell
- Knit Back Helps Keep Hand Cooler Longer



- SKU **250887** SAS6401909 (L) **39⁹⁹**
- SKU **250888** SAS6401910 (XL) **39⁹⁹**
- SKU **250890** SAS6401911 (XXL) **39⁹⁹**

Washable and Reusable

**Derma-Lite Nitrile
 5 mil, Powder Gloves**

- Extra Strong Puncture and Abrasive Resistant
- Latex-Free
- Beaded Cuff
- Ambidextrous, Textured Grip



300 Gloves

3 Boxes of 100 Each, **\$19.99** Per Box

- SKU **222821** SAS6607PK3 (M) **59⁹⁹**
- SKU **265037** SAS6608PK3 (L) **59⁹⁹**
- SKU **265054** SAS6609PK3 (XL) **59⁹⁹**

1,000 Gloves

Case (10 Boxes, 100 Ea.), **\$16.99** Per Box

- SKU **227872** SAS6607CS (M) **169⁹⁹**
- SKU **265038** SAS6608CS (L) **169⁹⁹**
- SKU **265045** SAS6609CS (XL) **169⁹⁹**
- SKU **265050** SAS6610CS (XXL) **169⁹⁹**

Gloves

Hot Sleeve

- SKU **291321** LIS18700 **19⁹⁹**

- Made of Kevlar® to Protect Arms from Burns
- Double Wall Construction for Added Heat Protection
- Works for Either Right or Left Arm
- Sleeve is Washable



**Kevlar® Burn Protection
 Arm Glove**

- SKU **222467** LIS21260 **25⁹⁹**

- Total Hand and Arm Burn Protection
- Kevlar Protects Hands and Arms from Hot Surfaces
- Enables Work on Hot Engines and Exhaust Systems without Waiting
- For Right and Left Hands
- Glove Portion is Coated with a Vinyl Tread for Greater Gripping Power



**Magnetic
 Glove Box Holder**

- SKU **291322** LIS20130 **29⁹⁹**

- Magnetic Glove Dispenser Conveniently Attaches to Your Toolbox or Any Ferrous Metal Surface
- Two Large Magnets Hold the Dispenser in Place
- Uses Three Springs Which Can Be Adjusted as Necessary to Hold the Various Box Sizes



Extra Strength Disposable Gloves*



- Powder-free exam grade nitrile
- Thickness: 6 mil
- Non-latex
- Outstanding strength, wear and dexterity
- Fully textured for enhanced gripping power
- 100 gloves per box

- SKU **435079** SAS66517 Medium **17⁹⁹**
STORE STOCK

- SKU **244622** SAS66518 Large **17⁹⁹**
STORE STOCK*

- SKU **244617** SAS66519 XLarge **17⁹⁹**
STORE STOCK*

* See store for availability



Dual-Sided Scale Grip Disposable Gloves



- Powder-free nitrile
- Thickness: 7 mil
- Dual-sided scale textured surface for superior grip
- High-visibility safety orange color
- Non-latex
- Exceptional chemical and puncture resistance
- Maximum comfort allows for extended wear
- 100 gloves per box

- SKU **823166** SAS66572 Medium **17⁹⁹**
STORE STOCK

- SKU **823167** SAS66573 Large **17⁹⁹**
STORE STOCK

- SKU **823168** SAS66574 XLarge **17⁹⁹**
STORE STOCK



www.sassafety.com



SHOP SUPPLIES

OEM TOOLS Quality • Innovation • Value



Drinks Stay Hot or Cold to the Last Sip



10 Oz. Stainless Steel Tumbler
SKU 096882 26010 **24⁹⁹**



20 Oz. Stainless Steel Tumbler
SKU 096878 26009 **24⁹⁹**



30 Oz. Stainless Steel Tumbler
SKU 096881 26008 **29⁹⁹**

- Made with Durable Kitchen-Grade 18/8 Stainless Steel
- Double-Wall Vacuum Insulation Maintains the Temperature of Your Drink
- "No Sweat" Design Keeps Fingers Dry and Comfortable
- Ideal for Office, Home, Garage, Anywhere
- Keeps Ice 2 Times Longer Than Plastic Tumblers
- BPA Free



3 Piece Tumbler Box Set
SKU 096887 26014 **59⁹⁹** REG. \$69.99

SAVE \$10

- Jackhammer: 30 Oz. Tumbler
- Hammer: 20 Oz. Tumbler
- Chuck: 10 Oz. Double-Wall Vacuum Insulation Keeps Drinks Cold or Hot to the Last Sip
- Made with Durable Kitchen-Grade 18/8 Stainless Steel
- BPA Free
- Includes Decorative Gift Box

Offers Good Through June 30, 2017 While Supplies Last

4 Piece Copper Lowball Box Set
SKU 527867 26015 **59⁹⁹** REG. \$69.99

SAVE \$10

NEW

- Includes (4) 10 Oz. Copper Colored Lowballs
- The Perfect Size for Your Morning Coffee or Evening Toddy
- This Lowball Fits Easily in Your Hand
- Comes with Replaceable Shatter-Proof Lid
- Made with Durable Kitchen-Grade 18/8 Stainless Steel
- Finished in a Copper Colored Coating
- No Sweat Design Keeps Fingers Dry and Comfortable
- Double-wall Vacuum Insulation Keeps Drinks Cold or Hot to the Last Sip
- Keeps Ice 2x Longer than Plastic Tumblers
- Comes in a Decorative Storage Box, Ready to Gift



Truck Step

Adjustable Tire Step
SKU 818571 24913 **24⁹⁹** REG. \$34.99

SAVE \$10

- Fits Both Front and Rear 9" to 13" Wide Tires
- Powder Coat Finish
- Designed for SUVs, Motor Homes and Light-Duty Trucks
- Heavily Textured Non-Slip Step for Safety
- Adjustable Rubber Bumpers Protect Your Wheels and Ensure the Step is Sturdy and Level
- Easy to Adjust
- Weight Capacity: 300 Lbs.



Offer Good Through June 30, 2017 While Supplies Last

Work Stand

Pro Step Adjustable Work Stand
SKU 222856 STK20350 **164⁹⁹**

- 500 Lbs. Capacity
- 32" x 16"
- Height Adjustable from 6-1/2" to 22-1/2"



Trays

10" x 11" Magnetic Tray
SKU 965835 25119 **24⁹⁹**

- OEM Magnetic Trays are Strong and Durable to Collect Small Parts, Fasteners and Tools
- Four Powerful Magnets with Protective Rubber Coating to Resist Scratching
- Ideal for Holding Small Parts and Tools
- Heavy Duty Stainless Steel



Magnetic Nut Cups, 2 Pack

SKU 592211 25115 **29⁹⁹**

NEW

- No More Crawling Around on the Ground Looking for a Fallen Fastener or Nut
- Magnetic Cups Hold Nuts, Bolts, Parts and Screws Securely Until You Need Them
- Strong Magnets Attach the Cups Securely to Flat Metal Surfaces
- Matching Magnetic Cups Come in a Pair and Are Shipped in a Handsome Display Box

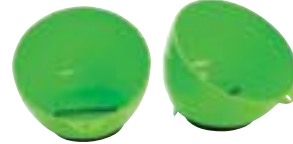

Fender Covers

Fender Cover
SKU 818712 24902 **19⁹⁹**

- Heavy Gauge Vinyl Wipes Clean
- Sewn-in Tool Ridge
- 27" x 34"
- Won't Mar or Scratch Surface



Soft Fleece Fender Cover

SKU 751711 24899 **24⁹⁹**

- Soft Fleece Fender Cover to Prevent Paint Damage and Strong Magnets to Hold Cover in Place
- Two Super Powerful Corner Magnets for Securing the Cover in Place
- Magnets are Removable to Wash the Cover
- Large 42 In. x 24 In. Size for Cars, Trucks, and SUVs



Fender Cover

SKU 965832 24900 **19⁹⁹** REG. \$22.99

- Heavy Gauge Vinyl Wipes Clean
- 27" x 34"



Offer Good Through June 30, 2017 - While Supplies Last

Non-Slip Fender Cover

SKU 447120 80-205 **24⁹⁹**

- Heavy Gauge Vinyl Wipes Clean
- 24" x 36"



Shop Supplies

Work Ticket Holder (25/Box)
SKU 698887 SNGFBP993302 **44⁹⁹**

- Durable Brass Grommet Increases Strength
- Accommodates Most Pre-Printed and Computer Generated Forms
- Dimensions: 14.5" x 10.5"



Paper Floor Mats

SKU 186484 SNGM002PW226 **49⁹⁹**

- Coated Paper "Footprint" Style
- Box of 500
- 17" x 22"

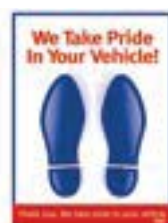

Value Coated Paper Floor Mats (500/Case)

SKU 262539 SNGM0758LX226 **51⁹⁹**

- 17" x 19" Plain Paper Mat
- Reusable
- Disposable
- Dispenses Off of Roll



White Plastic Key Tag Write On (1,000 Count)

SKU 262547 SNGMFBP993323 **22⁹⁹**

- Self Locking Plastic Key Tags Help Secure Keys
- Write On
- 1,000 Count



Plastic Floor Mats

SKU 186488 SNGMFGP994302 **59⁹⁹**

- Slip-N-Grip® Plastic Disposable Mat
- Box of 500
- Roll 16.5" x 21"



Adhesive Floor Mats (175/Roll)

SKU 262546 SNGMFBP993349 **99⁹⁹**

- Self Adhesive, 3 mil Protective Film Keeps Carpet Protected



Steering Wheel Cover (500/Box)

SKU 186485 SNGMFBP994333 **59⁹⁹**

(250/Box)
SKU 262538 SNGMFBP994336 **39⁹⁹**



Start-Up Kit (Dispenser and Product)
SKU 262544 SNGMFKP994376 **379⁹⁹**

- (250) Seat Covers, (500) Plastic Floor Mats, (500) Parts Bags, (250) Steering Wheel Covers, (100) Tire Bags and (250) Paper Floor Mats



Disposable Value Seat Cover (500/Roll)

SKU 186487 SNGMFGP994315 **69⁹⁹**

(250/Roll)
SKU 262537 SNGMFGP994314 **49⁹⁹**

Oil Change Labels

Thermal Oil Change Sticker Printer

SKU 526488 SNGFKGX00106 **699⁹⁹**

- Kit Includes: Printer, Keyboard, Power Cord/Adapter, (1) Ink Ribbon and (2) Rolls of 500 Generic Static Cling Labels

Static Cling Refill Kit

SKU 291380 SNGMFKG016501 **119⁹⁹**

- (2) Rolls of Labels
- (1) Replacement Ribbon





Contact Us:
1-877-AZTool1 Phone
 (1-877-298-6651) *Hablamos Español*

Shop Stools

Adjustable Hydraulic Shop Stools

SAVE \$10

Green
 SKU 751712
 24912

OEM TOOLS

Orange
 SKU 298183
 24914

- Adjustable Hydraulic Stool
- Raises from 28" to 32.5"
- Vinyl-Padded Swivel Seat for Comfortable Support
- Chrome Foot Rests Won't Wear Out



Adjustable Hydraulic Stool That Raises from 28" to 32.5"

Offers Good Through June 30, 2017 - While Supplies Last

Buy 2 and SAVE

Two Swivel Shop Stools

SKU 432326
 24910TWO

79⁹⁹

- Swivel Seat
- Double Foot Ring for Strength
- Seamless Pad
- 30.5" High x 14" Across



Buy 2 and SAVE

Two Adjustable Hydraulic Stools

SKU 362969
 24911TWO

159⁹⁹

- Swivel Seat
- Double Foot Ring for Strength
- Cushioned Pad
- Raise from 28" to 32-1/2"



One Swivel Shop Stool

SKU 512951
 24910

49⁹⁹



One Adjustable Hydraulic Stool

SKU 512945
 24911

99⁹⁹



Shop Seats and Creepers

Anti Fatigue Kneeling Pad

SKU 125753
 24971

24⁹⁹

NEW

- Helps Prevent Damage to Knees
- EVA Construction is Resistant to Oil and Other Petroleum Products
- Great for Kneeling in Severe Conditions Such as Steel, Concrete, Grating and Gravel
- Includes Tool or Parts Storage Cutout
- 18" x 8" x 1"



Racing Body Board EVA Foam Creeper

SKU 125754
 24972

39⁹⁹

NEW

- EVA Construction is Water, Chemical and Impact Resistant
- Includes Handle and Two Tool Compartment Cutouts
- Great for Both Garage and Outdoors
- Lightweight Construction is Portable and Easy to Stow
- 41" x 18" x 1"



Professional 41" 6 Wheel Creeper

SKU 125749
 24970

119⁹⁹

NEW

- 3D Streamline Design for Shoulder Clearance
- 6 Heavy Duty TPU Casters Roll Easy and Are Resistant to Oil, Grease and Abrasions
- Low Ground Clearance Allows For Greater Mobility and Clearance Under Vehicles
- 4 Tool Storage Trays on Each Side and Next to the Headrest



Tractor Seat Creeper

SKU 301771
 24953

SAVE \$10

89⁹⁹ REG. \$99.99

- Tractor Style Shop Seat
- (4) Durable Swivel Casters
- Parts Tray



Offer Good Through June 30, 2017 - While Supplies Last

Z Creeper

SKU 536761
 C-2036D

49⁹⁹

Pro-Lift Creeper Chair in One Motion

STORE STOCK

- Easily transforms from a creeper to shop seat
- Six caster design
- Vinyl padded seat and headrest
- Heavy duty 36" steel frame
- 300 lb. rated capacity
- Patented design



Tool Box / Creeper Seat Combination

SKU 250704
 OMG92450

84⁹⁹

- 450 Lbs. Rated Capacity
- Steel Frame Construction
- Extra Thick Seat Cushion
- 3 Drawer Locking Tool Box



44" Aluminum Creeper

SKU 237641
 71004

99⁹⁹

- Lightweight and Strong Aluminum
- Adjustable Headrest



Hardware Kits

34 Piece Hose Clamp Assortment

SKU 271201
 68137

13⁹⁹

- Includes Sizes: 5/8" - 1-1/4"



96 Piece Mini Fuse Kit

SKU 271169
 68148

13⁹⁹

- Includes: Mini Fuses 3A - 30A



96 Piece ATO Fuse Assortment

SKU 271172
 68149

13⁹⁹

- Includes: ATO Fuses 3A - 30A



200 Piece Spring Assortment

SKU 271195
 68140

15⁹⁹

- Includes 20 Popular Sizes from 7/32" x 11/16" to 5/16" x 1-1/4"



300 Piece E-Clip Assortment

SKU 271188
 68145

15⁹⁹

- Includes: 1/16" - 7/8"



80 Piece Vacuum Cap Assortment

SKU 271197
 68129

15⁹⁹

- Includes Sizes: 3/16" - 3/8"



555 Piece Cotter Pin Assortment

SKU 271180
 68120

18⁹⁹

- Includes 6 Popular Sizes from 1/16" x 1" to 5/32" x 2-1/2"



500 Piece Aluminum Rivet Assortment

SKU 271150
 68109

18⁹⁹

- Includes: 1/8" and 3/16" Rivets 1/4", 5/16" and 3/8" Long



24 Piece Maxi Fuse Assortment

SKU 271152
 68146

18⁹⁹

- Includes: Maxi Fuses 20A - 100A



158 Piece Wire Connector Assortment

SKU 271200
 68131

18⁹⁹

- Popular Sizes for Joining 2, 3 or 4 Wires #22 - #10



240 Piece SAE Bolt, Nut and Washer Kit

SKU 271179
 68106

18⁹⁹

- Includes 20 Popular Sizes and Lengths from #8 to 3/8"



240 Piece Metric Bolt, Nut and Washer Kit

SKU 271149
 68107

18⁹⁹

- Includes Popular Sizes and Lengths: M4 - M10



250 Piece Welding Stud Assortment

SKU 271198
 68130

18⁹⁹

- 250 Pieces, Size 3/40"
- Use with Stud Welder or Stud Gun
- Copper Coated Steel Construction



270 Piece A/C O-Ring Kit

SKU 271196
 68141

21⁹⁹

- Contains 270 O-Rings in a Variety of SAE Sizes
- Great O-Ring Set for Most Automotive and Refrigerant Applications



88 Piece Master Auto Fuse Assortment

SKU 271161
 68147

23⁹⁹

- Includes: Popular Sizes of Mini, ATO and Maxi Fuses 3A - 100A



110 Piece Metric Copper Washer Assortment

SKU 271176
 68117

28⁹⁹

- Includes Popular Sizes: M6 - M16



555 Piece Stainless Cotter Pin Assortment

SKU 271183
 68121

38⁹⁹

- Includes 6 Popular Sizes from 1/16" x 1" to 5/32" x 2-1/2"

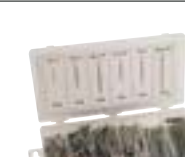

407 Piece Universal O-Ring Set (SAE)

SKU 546661
 68168

19⁹⁹

- (34) Popular Sizes
- Inside Diameters from 1/8" to 2"
- Complete with Secure Fit Latched Storage Case, Keeps Each Size Separate and Easy to Identify



419 Piece Universal O-Ring Set (Metric)

SKU 546659
 68167

19⁹⁹

- Pliable, Flexible Rubber Rings Seal Contact and Connection Points Like Mini Gaskets
- Inside Diameters from 3 mm to 50 mm



Heat-Shrink Tube Sets

106 Piece Waterproof Heat-Shrink Tube Set

SKU 420334
 68164

29⁹⁹

- Tubes Shrink to Fit Over Cable Splices and Can Be Used for Wire Harnessing, Covering, Marking and Bundling of Wires
- Adhesive Lined Inner Wall to Seal Out Moisture
- 3:1 Shrink Ratio
- Waterproof



REPAIR IT RIGHT

90 Piece Waterproof Heat-Shrink Terminal Set

SKU 462482
 68166

79⁹⁹

- (30) Ring Connectors
- (15) Butt Connectors
- (15) Tin Butt Connectors
- (15) Female Disconnects
- (15) Male Disconnects
- Re-Sealable Plastic Case



171 Piece Heat-Shrink Tube Set

SKU 420335
 68165

19⁹⁹

- Protection and Insulation of Components and Wires
- Protection Against Water and Moisture Ingress Preventing Corrosion
- Color Coordinated Sizes
- Quick and Simple to Shrink by Heat Gun



SHOP SUPPLIES

Recovery Tow Ropes

Kinetic Recovery Tow Ropes

- 45% Stronger and Lighter Than Wire Rope
- Does Not Curl, Kink or Pinch Itself
- Safer Than Wire Rope if the Line Breaks Due to Overloading
- 6" Eyes Have Protective Sleeve to Reduce Wear and Tear
- 2-to-3 Times Stronger Than Nylon Straps with Eyes
- Includes Protective Storage Bag



- 1/2" x 20'** SKU 751611 | MIB448501 • 7,300 Lbs. Capacity **59⁹⁹**
- 3/4" x 20'** SKU 751610 | MIB448511 • 16,000 Lbs. Capacity **99⁹⁹**
- 7/8" x 20'** SKU 751612 | MIB448521 • 24700 Lbs. Capacity **139⁹⁹**
- 7/8" x 30'** SKU 751619 | MIB448531 • 24700 Lbs. Capacity **174⁹⁹**
- 1-1/4" x 30'** SKU 751620 | MIB448541 • 44200 Lbs. Capacity **289⁹⁹**
- 1-1/2" x 30'** SKU 751613 | MIB448551 • 64,300 Lbs. Capacity **399⁹⁹**

REALTREE® 3 Pack of Magnetic Can Coolers

Xtra Camo, Flag Black, Par Pink
SKU 534394
RELCANCOOL-3 **29⁹⁹**

- Machine Washable
- Magnets Adhere to All Metal Surfaces
- Constructed of Stretchable Neoprene Rubber
- Vinyl with Insulated Foam
- Black Interior Foam
- Collapsible for Easy Storage

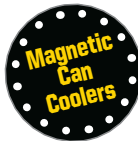

Cans Not Included

REALTREE® Window Films **49⁹⁹**

- See Through Design Allows for Unrestricted View Out Rear Window
- Adds Privacy and Helps Keep Truck Cool by Blocking UV Light
- Air Release Technology for Easy, Bubble-Free Installation
- Graphic Measures 20" x 66"

- Xtra Camo**
SKU 534398 | RELRTWF-XT-RL
- Max 5 Camo**
SKU 534395 | RELRTWF-MX5RL
- Whitetail - Xtra Camo**
SKU 534396 | RELRTWF-WT-XT
- Duck - Max 5 Camo**
SKU 534399 | RELRTWF-DKMX5



RELRTWF-XT-RL



RELRTWF-MX5RL



RELRTWF-WT-XT



RELRTWF-DKMX5

Trucks Not Included

USB Charger

Smart 6 Port 8A USB Wall Charger 24649 **24⁹⁹**

- Charges up to 2 Tablets and 4 Smartphones at One Time
- Compatible with all USB Enabled Smartphones, Tablets, Wireless Speakers and Headsets, Digital Cameras and More
- Smart Charging Function: Distributes the Safest Current at the Fastest Possible Speed to Your Devices
- 8 AMP Max Output

NEW

OEM TOOLS



- 6 USB Ports
- Smart Devices
- Smart Devices
- Apple Devices
- Apple Devices
- Android Devices
- Android Devices

REALTREE® Tailgate Graphics **74⁹⁹**

- Adhesive Vinyl Graphic
- Graphic Measures 26" x 66"
- Fits Most Full-Sized and Mid-Sized Trucks
- Air Release Technology for Easy, Bubble-Free Installation
- Matte Finish

- Xtra Camo**
SKU 534413 | RELRTTG-XT-RL
- Max 5 Camo**
SKU 534414 | RELRTTG-M5-RL
- Whitetail - Xtra Camo**
SKU 534415 | RELRTTG-WT-XT
- Duck - Max 5 Camo**
SKU 534401 | RELRTTG-DKMX5

OEM TOOLS



RELRTTG-XT-RL



RELRTTG-M5-RL



RELRTTG-WT-XT



RELRTTG-DKMX5

Trucks Not Included

FAILED LIFT SUPPORTS CAN BE DANGEROUS AND CAUSE INJURY



YOUR CUSTOMER'S LIFT SUPPORTS MAY NEED TO BE REPLACED

IT'S FAST... WON'T TIE UP THE BAY

IT'S EASY... ANYONE IN THE SHOP CAN DO IT

NO SPECIAL TOOLS REQUIRED

TRUSTWORTHY BRAND

» Direct fit style for proper function and long life «

» Affordable - saves a trip to the dealership «

» Customer Satisfaction «

MIGHTY LIFT!
GAS CHARGED LIFT SUPPORTS



Contact Us:
1-877-AZTool1 Phone
 (1-877-298-6651) *Hablamos Español*



Approved Outside Buy Vendor

Call to place your order:

855.277.3074 toll free • 561.689.2064 fax

YOUR TRUSTED BUSINESS PARTNER – TODAY, TOMORROW & BEYOND!

Spray Equipment

Mixing Cups and Lids

MC32
 1 quart cups **55⁹⁹**

- Strong, Durable, and Tough Polypropylene Cup is Crack Resistant
- Easy to read for proper mixing every time
- Solvent Resistant
- Made in the USA.
- 10% reduction option has been added to the four popular mixing scales



Case of 100

Disposable Cup System

- Better fluid flow for great color match
- Positive locking gun connection
- Refill without opening the cup
- Self-dispensing packaging
- Larger capacity cups



32 per box

Part No.	Description	Price
DPC-600	34 fl. oz cup/lid	\$78.50
DPC-601	24 fl. oz cup/lid	\$64.55
DPC-602	9 fl. oz cup/lid	\$52.45

Tekna ProLite Gun

703566
609⁹⁹

- TE10 & TE20 Air Caps
- 1.2, 1.3 & 1.4 Fluid Tips
- 900cc Cup



Tekna ProLite Gun

703567
559⁹⁹

- TE10 & TE20 Air Caps
- 1.2, 1.3 & 1.4 Fluid Tips
- Uncupped w/adaptor



- Optimized performance in climates varying from hot and humid to cold and dry
- Three air caps developed using advanced fluid dynamics technology for excellent atomization
- Packaged as a solution with multiple components allowing the painter to adapt to changing environments
- Excellent for solvent-based coatings and a must for waterborne
- Fully protected outside and inside for high corrosion resistance — gun coating has non-stick properties
- High transfer efficiency for material savings

3-Gun HVLP Paint and Touch Up Gun Set

T530
99⁹⁹

- One year OTC warranty
- Includes three Performance Series spray guns with aluminum cups: 1.0mm touch up, 1.4 mm topcoat, and 1.7 mm primer
- Also includes locking pressure regulator, fluid filter, gun cleaning kit and service tools
- Avg. air consumption: 7-9 CFM
- Air inlet threads: 1/4"



12 pc Spray Gun Cleaning Kit

T550
9⁹⁹

- Designed for use with both HVLP and Conventional systems
- Safe with all thinners & solvents
- Specially-formulated lubricant for spray guns

KIT INCLUDES:

- (1) Body Cleaning Brush with wooden handle
- (1) External Brush with metal handle
- (3) Fluid Tube Brushes with metal handles
- (1) Straight Line Wire
- (5) Picks
- (1) Jar of Lubricant



Paint Suit

49⁹⁹

- Innovative design to reduce heat build up, work in comfort
- Interwoven Carbon Fibre thread dissipates electrostatic charges, less re-works
- Lint Free densely woven polyester multi filament yarn
- Separate hood, allowing freedom of movement
- Vented back and under arms
- 2-way zipper
- Front Chest Pocket; Back pocket
- Elastic back
- Extremely lightweight
- Breathable
- Machine Washable



Part No.	Size	Color
PS105B	M	Black
PS110B	L	Black
PS115B	XL	Black
PS120B	2XL	Black
PS125B	3XL	Black
PS205W	M	White
PS210W	L	White
PS215W	XL	White
PS220W	2XL	White
PS225W	3XL	White



TEKNA ProLite 1.3 mm and 1.4 mm Fluid Tip Spray Gun

703517
559⁹⁹

- 1.3mm and 1.4mm fluid tips
- TE20/HV30 Air Cap



- Optimized performance in climates varying from hot and humid to cold and dry
- Three air caps developed using advanced fluid dynamics technology for excellent atomization
- Packaged as a solution with multiple components allowing the painter to adapt to changing environments
- Excellent for solvent-based coatings and a must for waterborne
- Fully protected outside and inside for high corrosion resistance — gun coating has non-stick properties
- High transfer efficiency for material savings

Gun Washer with Timer

G200
1,139⁹⁹

- Cleans 2-4 spray guns with automatic timer
- Large tank to work in, small foot print
- Made in the USA.
- Safety shut off



5 GL Solvent Recycler

URS500
3,449⁹⁹

- Tank Capacity: 5.0 US Gal (20 litres)
- Speed: 5.0 US Gal in about 4 hours
- Solvent Transfer: Manual
- Power Supply: 110/120V, 1500W, 13.3A
- Heater: 1500W
- Display: LEDs indicate power on, heat on and 6 temperature set points



Color Match Light 5000K-6500K

HH1
118⁹⁹

- Rapid recharge (AC adaptor and USB cable included)
- Diffuser lens (For larger illumination area)
- Carrying case with belt clip
- Charge light indicator
- Built-in clip hook
- Cordless



Portable Work Stand

Portable Work Stand (16 lb)

T430
45⁹⁹

- Lightweight work bench with capacity of 500lbs
- Steel tubing construction with 1/2" foam padded top
- Great for working on doors, fenders, hoods and bumpers
- 1 Year Limited Warranty
- Adjustable height of 33" to 40" tall
- Unassembled



Double-Sided Tape

Double-Sided Tape

- Applications
 - Bumper Trim
 - Body Side Moldings
 - Claddings
 - Wheel Flares
- Emblems
- Other Exterior Trim Parts



Part No.	Size	Price
3682	1/2" x 20 yds	\$29.99
3683	7/8" x 20 yds	\$43.99
3684	1/2" x 5 yds	\$10.99
3686	1/4" x 20 yds	\$17.99

Gold Abrasives

6" Gold PSA Discs

- Resistant to clogging and loading
- P-grade aluminum oxide offers an exceptional long lasting cut
- High strength resin bonding gives superior grain support producing an even, consistent scratch pattern



100 per box

Part No.	Grit	Price	Part No.	Grit	Price
6036	36	\$54.99	6180	180	\$30.99
6080	80	\$33.99	6220	220	\$30.99
6100	100	\$30.99	6320	320	\$30.99
6120	120	\$30.99	6400	400	\$30.99
6150	150	\$30.99			

Aluminum Repair

Aluspot Aluminum Repair Station

DF900DX
6,595⁹⁹

Everything that is needed to pull damaged aluminum panels is included with this system plus more. From repair to proper storage the Ford approved, DF-900DX allows any shop to start working on highly profitable aluminum repairs. The 5 steps for aluminum repair are covered: Expose the bare aluminum, apply heat, weld pins, pull the dent, and shaping the dent.





Do you want to help customers see better and drive safer?
 SYLVANIA Automotive Lighting has options for an improved driving experience

SYLVANIA zXe®

HID Attitude // Xenon Fueled

- The perfect balance of performance and style.
- Cobalt blue nano coating technology to deliver our **whitest halogen***
- Mirror Top alloy coating
- 100% street legal and DOT approved



SYLVANIA SilverStar® ULTRA

Farthest Downroad and Whiter Light*

- Whiter color*
- Most downroad*
- More clarity*
- For ULTRA night vision
- Does not increase glare



SYLVANIA SilverStar®

Farther Downroad and Whiter Light*

- Whiter color*
- More downroad*
- More clarity*
- Does not increase glare



SYLVANIA XtraVision®

Farther Downroad*

- More downroad*
- Does not increase glare



HID Portfolio

SYLVANIA XENARC and zXe® HID

- OEM quality, precision, and consistent performance that complies with SAE regulations
- SYLVANIA zXe® HID produces an intense white light
- Superior visibility with 3 times more light output than halogen lighting
- Trusted Quality from America's #1 Automotive Lighting Manufacturer

Family	BASIC	zXe®
D1R	✓	✓
D1S	✓	✓
D2R	✓	✓
D2S	✓	✓
D3R	✓	
D3S	✓	✓
D4R	✓	
D4S	✓	✓
D8S	✓	



Available Single and Twin Packs in Sylvania Capsules

PART	BASIC	XV	ST	ULT	ZXE
9006	SN/TW	SN/TW	SN/TW	SN/TW	TW
H11	SN/TW	SN/TW	SN/TW	SN/TW	TW
9007	SN/TW	SN/TW	SN/TW	SN/TW	TW
H7	SN/TW	SN/TW	SN/TW	SN/TW	TW
9003	SN/TW	SN/TW	SN/TW	SN/TW	TW
9005	SN	SN/TW	SN/TW	SN/TW	TW
H1-55W	SN	SN	SN	SN/TW	TW
H13	SN	SN/TW	SN/TW	SN/TW	TW
9004	SN/TW	SN/TW	SN/TW	SN/TW	TW
9145	SN		SN		TW
H3-55W	SN		SN		TW
9006XS	SN		SN		TW
880	SN		SN		TW
881	SN				TW
9005XS	SN		SN		TW
893	SN		SN		

Only Offered in BASIC Single: H11B, H9, 9012, H8, 899, 9140, H3-100W, 5202, 898, 896, 894, 886, 2504, 885, 889, 9011, 5201, 891, 9040, H16, H15

SN = Single TW = Twin

Miniature Replacement Bulbs

SYLVANIA LEDs

- Direct Replacement for incandescent bulbs
- 77 bulbs covering 94% applications

SYLVANIA ZEVO®

- ZEVO LIFETIME WARRANTY
- Superior quality
- Longer Life than incandescent bulbs
- Low power consumption



SYLVANIA LED

- Longer Life than incandescent bulbs
- Low power consumption



Traditional Incandescent

- Direct Replacement for OE miniature bulbs

SYLVANIA SilverStar®

- Whiter color*
- Improves contrast and clarity



SYLVANIA LongLife

- Longer Life than Basic bulbs
- 99% Vehicle application coverage



SYLVANIA

*Compared to only SYLVANIA BASIC

Hand Cleaner

Cleans the Toughest Dirt...

OEM TOOLS

World's Best Hand Cleaner

- All Natural, Concentrated, Solvent Free Cleansing Formula
- Unique Skin Conditioning System Leaves Hands Feeling Smoother, While Fibril Scrubbers Deep Clean Even the Toughest Dirt
- Cherry Fragrance Leaves Hands Smelling Great
- 100% Biodegradable

Starter Kit with BONUS Dispenser

SKU 972773 **34⁹⁹**
24292

- Kit Includes Wall-Mount Dispenser and 4,000 mL of Cherry Fragrance Cleaner

4000 mL Refill Bottle

SKU 972772 **34⁹⁹**
24291

Cherry Fragrance Leaves Hands Smelling Great



24291



24292

LED Safety Glasses

- Polycarbonate Frame and Lenses
- Light Output: 24 Lumens
- (4) CR1632 Batteries



Vindicator

SKU 555987 **19⁹⁹**
LSSG-279760

- Black Glossy Finish



ANSI Z87.1-2010 Rated



Predator

SKU 514090 **19⁹⁹**
LSSG-280377

- Camo Glossy Finish

Introducing EiKO® Commercial Lighting Program, now available at AutoZone®, offering:

- Full line supplier of quality products that meet or exceed all OE manufacturer requirements & specifications, including DOT, SAE and ANSI industry standards
- Original Equipment supplier to many of the large vehicle manufacturers
- Widest selection of lamps in the industry, with over 99.1% coverage of vehicles in operation since 1958

Original Equipment Halogen

- Durable lamps with reliable performance
- Quality light output for superior visibility • Meets or exceeds OE specifications



\$14.99
SKU 312628
PART# H11B

\$6.99
SKU 312601
PART# 9003

\$6.99
SKU 312615
PART# 9007

\$9.99
SKU 312625
PART# H755

\$9.99
SKU 312627
PART# H1155

\$6.99
SKU 312609
PART# 9006

High Intensity Discharge (HID)

- Better visibility and illumination • Lower power consumption • Greater durability



\$59.99
SKU 312630
PART# D2R

\$59.99
SKU 312631
PART# D2S

\$69.99
SKU 312634
PART# DIS

\$69.99
SKU 312633
PART# DIR

\$69.99
SKU 312632
PART# D4S

Miniatures

- Dashboard, interior lamp, signals, brake light offering • Patented 3000 series bulbs • LED offering available



\$5.99
SKU 312605
PART# 168

\$5.99
SKU 312579
PART# 194

\$5.99
SKU 312581
PART# 912

\$5.99
SKU 312582
PART# 921

\$6.99
SKU 312583
PART# 1156

\$6.99
SKU 312584
PART# 1157

\$24.99
SKU 312629
PART# 2504

\$9.99
SKU 312588
PART# 3057

\$9.99
SKU 312589
PART# 3157

\$11.99
SKU 312600
PART# 3157NA

\$11.99
SKU 312597
PART# 7443

Sealed Beams

- Popular fleet and off-road applications available • Widest selection of incandescent types • Quality construction



\$6.99
SKU 312635
PART# 4411

\$12.99
SKU 312610
PART# H7635

\$12.99
SKU 312638
PART# 4636

\$9.99
SKU 312636
PART# 4412A

Cabinet Program

\$129.99

- Conveniently stores and displays popular lamps
- See-through bins offer easy product selection
- Durable and long lasting
- Easily wall-mounted or placed on any flat surface
- 110 bulbs included

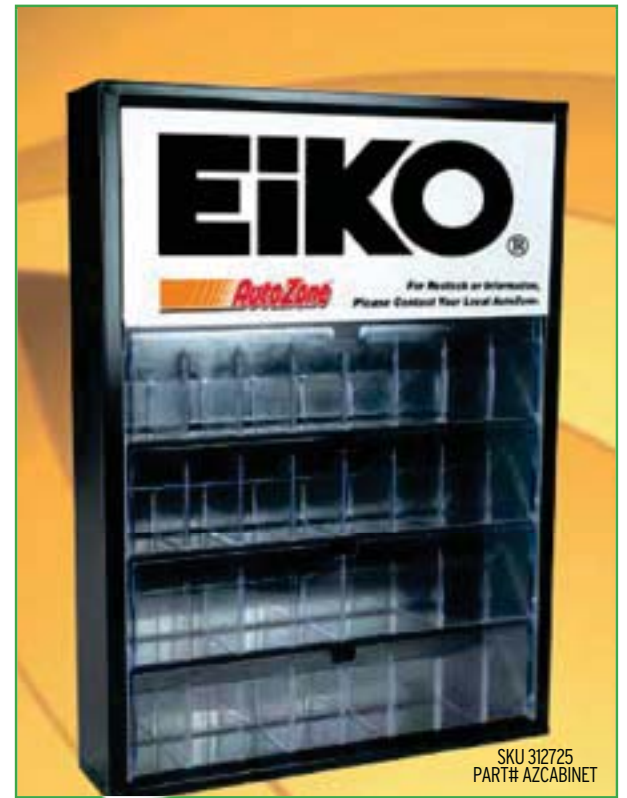

SKU 312725
PART# AZCABINET

Miniatures - 10 packs



SKU 312605
PART# 168

SKU 312579
PART# 194

SKU 312582
PART# 921

SKU 312583
PART# 1156

SKU 312584
PART# 1157

SKU 312586
PART# 2057

SKU 312587
PART# 2825

SKU 312588
PART# 3057

SKU 312589
PART# 3157

SKU 312597
PART# 7443

OE Halogens - 2 packs



SKU 312601
PART# 9003

SKU 312609
PART# 9006

SKU 312625
PART# H755

SKU 312627
PART# H1155

SKU 312615
PART# 9007



Got Questions?

Call AutoZone®
Tool & Equipment
Customer Service:

1-877-AZTool1 (phone)
(1-877-298-6651)
HABLAMOS ESPAÑOL

April, May and June 2017

Call Center Hours of Operation:
7:00AM to 5:00PM Central Standard Time

Shop Stools

Adjustable Hydraulic Shop Stools

Green
SKU 751712
24912

Orange
SKU 298183
24914



69⁹⁹
REG. \$79.99

SAVE \$10

- Adjustable Hydraulic Stool
- Raises from 28" to 32.5"
- Vinyl-Padded Swivel Seat for Comfortable Support
- Chrome Foot Rests Won't Wear Out

Offers Good Through June 30, 2017
While Supplies Last

SEE DETAILS, PAGE 115 >>>

Blower Fans

Portable Mechanic's Fan - 1200 CFM

SKU 850066
24878

89⁹⁹



- For Indoor or Outdoor Use
- 4 Position Feet
- Great for Use in Shops, Offices, Homes and Other Locations
- 3 Speed Switch
- (2) 11 Amp Grounded Receptacles with Over Current Protection

SEE DETAIL, PAGE 21 >>>

Shop Equipment

Digital Tire Inflator

SKU 802198
24412

49⁹⁹
REG. \$59.99



SAVE \$10

- Easy-to-Read Backlit LCD Display
- Four Units of Measure (PSI, Bar, KPa, kgf)
- Measuring Range: 0 - 12 Bar (0 - 175 PSI)

Offer Good Through June 30, 2017 - While Supplies Last

SEE DETAILS, PAGE 40 >>>

18" Floor Fan

SKU 592201
24881

69⁹⁹

NEW

OEM TOOLS



- Complete Metal Structure with Rotary Switch on Fan Guard
- V-Shaped Base with Pivoting Arms Allows the Fan to be Tilted
- Rear Handle for Easy Transportation
- 3 Black Aluminum Blades Produce 4500 CFM
- 3 Speed, 1.05 Amp Motor
- 5' UL Listed Power Cord
- 120V/60Hz

SHOP SUPPLY OF THE MONTH
JUNE
SEE INSERT FOR DETAILS

SEE DETAILS, PAGE 21 >>>

42 Piece 3/8" Impact Socket Set in EVA Foam Tray

SKU 087600
23983

124⁹⁹



Includes EVA Tray for Convenient Storage

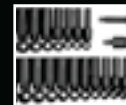

3/8" Drive and Deep Drive 6-Point SAE and Metric Sockets



Extension Bar and Universal Joint Bar

- (8) 3/8" Drive 6-Point SAE Sockets, Sizes 5/16"-3/4"
- (12) 3/8" Drive 6-Point Metric Sockets, Sizes 8 mm-19 mm
- (8) 3/8" Deep Drive 6-Point SAE Sockets, Sizes 5/16"-3/4"
- (12) 3/8" Deep Drive 6-Point Metric Sockets, Sizes 8 mm-19 mm
- Extension Bar
- Universal Joint Bar

TOOL OF THE MONTH

MAY
SEE INSERT FOR DETAILS

Fluid Handling

No-Spill Coolant Filling Funnel Kit

SKU 802197
87009

29⁹⁹



- 5 High Quality 1 Piece Adapters - No Assembly or Searching for Loose Parts
- Simply Select the Correct Adapter, Attach the Funnel and Fill
- Includes Extensions and Adapters for Hard-to-Reach Surge Tanks

SEE DETAILS, PAGE 66 >>>

Fluid Evacuator (1.4 Gallon)

SKU 544744
24389

74⁹⁹
REG. \$79.99

SAVE \$5

OEM TOOLS



- 1.4 Gallon (5.6 Quarts, 5.3 Liters) Reservoir with Hand Operated Pump
- 5 Ft. of Flex Hose and (2) Dipstick Hoses
- Use to Extract Most Fluid Types: Engine Oil, Transmission Fluid, Gear Oil, Coolant, Power Steering Fluid

Offer Good Through June 30, 2017 - While Supplies Last

SEE DETAILS, PAGE 65 >>>

Your Choice

Professional 3-in-1 Soldering Iron Kit

SKU 420338
24355

34⁹⁹
REG. \$39.99

SAVE \$5



Offer Good Through June 30, 2017
While Supplies Last

Professional 3-in-1 Butane Micro Torch Kit

SKU 420339
24356

34⁹⁹
REG. \$39.99

SAVE \$5



Offer Good Through June 30, 2017
While Supplies Last

SEE DETAILS, PAGE 27 >>>

Leak Detection

A/C Refrigerant Leak Detector

SKU 466307
24510

79⁹⁹
REG. \$99.99

SAVE \$20

OEM TOOLS



- Detects All Types of Halogenated Refrigerants
- Sensitive to 0.1 Oz/Yr.
- Single Color LED Display with 7 Level Leak Alarm
- Flexible Stainless Steel Probe to Reach to Almost Any Space
- Includes Spare Sensor Tip

Offer Good Through June 30, 2017 - While Supplies Last

SEE DETAILS, PAGE 32 >>>

Air Tools

Air Tire Buffer

SKU 802218
24410

79⁹⁹
REG. \$89.99

SAVE \$10



- Recommended Air Pressure: 90 PSI
- Air Consumption: 3.5 CFM
- Free Speed: 2,600 RPM
- Air Inlet Thread Size: 1/4" NPT
- Minimum Hose Size: 3/8"

Offer Good Through June 30, 2017 While Supplies Last

1/2" Composite Impact Wrench

SKU 347258
24400

199⁹⁹
REG. \$299.99

SAVE \$100

OEM TOOLS

Air Consumption
5.1 CFM



- Max. Torque: 900 Ft./Lbs.
- Air Consumption: 5.1 CFM
- Air Inlet Thread: 3/8"
- Weight: 4.58 Lbs.
- Sound Level: 96.2 dB(A)

Offer Good Through June 30, 2017 - While Supplies Last

SEE DETAILS, PAGES 41 and 78 >>>

SHOP SUPPLY OF THE MONTH

MAY
SEE INSERT FOR DETAILS

NEW

OEM TOOLS

Black & Green LED Safety Glasses, 3 Pack

SKU 592265
26017PK3

29⁹⁹

- High-Impact Polycarbonate Lenses
- Soft Thermoplastic Rubber Arm Ends Provide Added Comfort
- 100% UV Protection



Hand Tools

64 Piece 1/4" Drive Mechanic's Set in EVA Foam Tray

SKU 020788
23997

159⁹⁹
REG. \$199.99

SAVE \$40



EVA Trays
Feature a Hard Top Carbon Fiber Style Finish That Makes for a Lifelong Lasting Tray

Offer Good Through June 30, 2017
While Supplies Last

SEE DETAILS, PAGE 107 >>>

8 Piece Mechanic's Screwdriver Set in EVA Foam Tray

SKU 802208
23999

79⁹⁹

OEM TOOLS



- Slotted: 1/4" x 1-1/2", 3/16" x 3", 1/4" x 4", 5/16" x 6" and 3/8" x 8"
- Phillips: #2 x 1.5", #1 x 3" and #2 x 4"

Black Magnetic Tip

Hex Bolster
Hex shaped bolster for when you need more turning power

Unique Ergonomic Handle
3 sided handle feels good in your hands

SEE DETAIL, PAGE 107 >>>

TOOL OF THE MONTH

JUNE
SEE INSERT FOR DETAILS

OEM TOOLS

Multi-Use Rechargeable Diagnostic Work Light

SKU 591153
24609

109⁹⁹

NEW

- 3 Different Light Modes - White, Yellow (Smoke Detection), UV/Black (Leak Die Detection)
- 400 Lumens of Super Bright Light Lasts Over 5 Hours Using White Light



Lease to Own Equipment

Financing is provided by third parties who are not affiliates of AutoZone. All of the advertised loan programs, rates, terms and conditions are subject to change at any time without notice. An extra charge may be imposed at the end of the lease depending on the residual value of the leased goods.

©2017 AutoZone, Inc. All rights reserved. AutoZone, AutoZone & Design, Loan A Tool, Duralast, Duralast Gold and Duralast ProPower are registered marks of AutoZone IP LLC or one of its affiliates. All other marks are the property of their respective holders. iPhone® is a registered trademark of Apple Inc., Android® is a trademark of Google Inc., and Bluetooth® is a trademark of Bluetooth SIG, Inc. Items requiring freight shipping cannot be delivered outside of the continental United States. For shipping cost to Alaska or Hawaii, please contact Commercial Sales Manager. Ad prices cannot be combined with any other offer. Offers may vary by market. Offers valid while quantities last. Items may not be available at all locations at all times. We reserve the right to limit quantities and to correct pricing errors. Some new items might not be available at the time of print deadline. Prices valid only during sales catalog effective dates. All photographic, clerical, typographical and printing errors are subject to correction. Images shown may not be actual product but represent products or sets which include product. We reserve the right to substitute a like item or an item of greater value on any promotional offer in this publication. Store stock items may be purchased at any local AutoZone store or through your AutoZone Commercial Sales Manager.



Be Car Care Aware

AZG0217 | SKU 995945 \$2.99

