

ALIGNMENT, PAGES 13-15



DWA1000XL with 10,000 Lb. 2 Post Lift

SKU OUTSIDE BUY/EPO ALIGNCOMB015 **13,999⁹⁹**

We've combined the easy to use and economical CEMB DWA1000XLK CCD Alignment System with the reliable Forward I10 2-Post Lift for a space and money saving deal that can't be beat!

• Package Includes: CMBDWA1000XLK Alignment System and FORI10 10,000 Lb. Lift

Lift Gate Service 60⁰⁰
SKU 765535 CMBLIFTGATE

Looking for a Higher Capacity Lift? Take a Look at our Alignment (p.13) and Lifts (p.16) Sections for More!



Set-Up and Training Included!

Available via Outside Buy/EPO. Call 1-877-298-6651 for Ordering Instructions

Price does not include vehicles, installation or optional equipment as shown

TIRE SERVICE, PAGES 6-12



R140i and R138 Tire Service Combo

SKU OUTSIDE BUY/EPO ROTCOMB01 **4,999⁹⁹**

SAVE \$299

The Rotary tire service combo puts quality equipment in your shop, delivering popular features at an affordable price to fit your budget.

- High Quality Swing Arm Changer and 2D Balancer at an Economical Price
- Balancer Features Auto Start, Digital Display, and Hidden Weight Program
- Liftgate Service Included

WARRANTY: 2 Years Parts and 1 Year Labor

Set-Up and Training Included!



ROTR138

ROTR140i

ROTCOMB01 Rotary R140i Tire Changer and R138 Wheel Balancer		
ROTR140i	R140i Tire Changer	\$3,019.99
ROTR138	R138 Wheel Balancer	\$2,279.99
	Regular Price	\$5,299.98
ROTCOMB01	COMBO PRICE	\$4,999.99
	SAVINGS	\$299.99

Available via Outside Buy/EPO. Call 1-877-298-6651 for Ordering Instructions

FINANCING PROGRAMS AVAILABLE
SEE PAGE 2 FOR DETAILS

AIR COMPRESSORS, PAGES 80-81



10 HP 120 Gallon Two Stage Single Phase Horizontal Reciprocating Duplex Air Compressor

SKU OUTSIDE BUY/EPO CPTRCP-C10121D **3,849⁹⁹**

RCP Series Compressors - Exceptional Strength

Available via Outside Buy/EPO. Call 1-877-298-6651 for Ordering Instructions



Lift Gate Service

SKU 361260 CPTLIFTGATE **125⁰⁰**

LIGHTING, PAGES 87-89



Slim Folding Rechargeable Work Light

SKU 081750 26028 **39⁹⁹**

- Includes (1) 18650 Battery, (1) USB Charging Cord and (1) Carabiner

350 Lumens on High/
175 Lumens on Low



Folds for Easy Storage



Rotates 360° and Swivels 180°

SERVICE TOOLS, PAGES 64-65

GM Harmonic Balancer Puller

SKU OUTSIDE BUY/EPO 25264 **119⁹⁹**



Time Saving Tool - No Need to Remove Radiator

- Designed to Remove Harmonic Balancers without Tapped Holes

Available via Outside Buy/EPO. Call 1-877-298-6651 for Ordering Instructions



THREAD REPAIR, PAGES 72-73

TOOL of the MONTH MARCH
SEE INSERT FOR DETAILS

10 Piece Spiral Type Bolt Extractor Set

SKU 081788 22988 **49⁹⁹**



Specialized Spiral Design for Secure Universal Grip

DIAGNOSTIC, PAGES 30-37



C-Pro 8" Tablet Scan Tool w/ Bluetooth & WiFi

SKU 201992 CDOC-PRO **899⁹⁹**

One Year Software Subscription

- Professional Scan Tool for Asian, European and Domestic Passenger Cars and Light Trucks
- Bluetooth Android Tablet



BATTERY SERVICE, PAGES 40-43

Cold Days? Cold Starts?

Check Out Our Full Line of Pocket Size Power Banks

Li-ion Jump Starters and Power Banks

- Jump Starts Trucks, Cars, Boats, ATVs and Other Vehicles
- Charges Phones, Tablets, and Other Personal Electronics
- Powerful, High Capacity Nano Lithium Battery



8000 mAh
SKU 765509 24474 **69⁹⁹** Reg. 89.99

SAVE \$20

12000 mAh
SKU 765539 24475 **161⁹⁹**

18000 mAh
SKU 765536 24476 **248⁹⁹**



Power Button
LED Flashlight with SOS Strobe
Jump Starter Output
2.1A Smart USB Outputs (2)
Charging Ports (2)



WE'RE HERE TO HELP

**Special Leasing
Offers Available.**

Contact Your
Commercial Sales Manager.



CUSTOMER CARE

We want your purchasing experience to be the best and to ensure you are satisfied. As our customer, you can expect fast, personalized and professional service.

Our Customer Service Associates Have Over 100 Years of Combined Experience in the Tool and Equipment Industry.

You Can Be Sure They Are Ready to Answer Your Questions and Give You the Support You Need to Manage Your Business and Keep Your Customers Satisfied.

Call 1-877-AZTool1 (1-877-298-6651)

Guiding You to the Right Products at the Right Price:

"What is the Right Tire Changer for My Shop?"

"I'm Looking for a Specific Item That's Not in This Quarterly."

"Can You Track Down My Order?"

"I'm Interested in Leasing Some Equipment."

"I Need My 4 Post Lift Repaired."

"I HAVE A PROBLEM!!!"

BUSINESSES CAN TAKE ADVANTAGE OF IRS S-179 TAX CREDITS ON EQUIPMENT PURCHASES.

CONTACT YOUR CPA FOR DETAILS.

What is the S-179 Tax Credit?

Section 179 of the IRS tax code allows businesses to deduct the full purchase price of qualifying equipment and/or software purchased or financed during the tax year. That means that if you buy (or lease) a piece of qualifying equipment, you can deduct the FULL PURCHASE PRICE from your gross income. It's an incentive created by the U.S. government to encourage businesses to buy equipment and invest in themselves. (Retrieved from http://www.section179.org/section_179_deduction.html)

FINANCING PROGRAMS

Ask Us About Our Tool and Equipment Purchase Programs

1 LEASING COMPANY

- ✓ Leases are Handled by Three Companies:

LCA LEASE CORPORATION
OF AMERICA
Financing you can trust.SM

MARLIN
EQUIPMENT FINANCE

UniSource Capital
Never give up...Never Surrender![®]

- ✓ Customer Must:
 - Select Equipment
 - Complete Credit Application
 - Receive Approval From Leasing Company
- ✓ Once the Transaction is Approved
 - PO Issued
 - Tool Ordered

2 30-60-90

- ✓ AutoZone[®] Credit Account in Existence for 6 Months
- ✓ Updated Credit Application with Agreement Section Completed and Signed
- ✓ No NSF Checks
- ✓ No Credit Holds 6 Months
- ✓ Credit Worthiness Minimum Equipment Cost
 - \$1K (Tax Must Be Included)
- ✓ 25% Minimum Down Payment
- ✓ 52 Week Sales Amount \$15K

3 EXTENDED TERMS

- ✓ 3 Years in Business (Credit Bureau Reporting)
- ✓ Updated Credit Application with Agreement Section Completed and Signed
- ✓ No NSF Checks for 1 Year
- ✓ 1 Year Satisfactory Payment History with AutoZone[®]
- ✓ Credit Worthiness Minimum Equipment Cost by Term
 - 6 Months \$3K
 - 9 Months \$6K
 - 12 Months \$8K or Greater
- ✓ 25% Minimum Down Payment
- ✓ Financial Statement
- ✓ 52 Week Sales Amount \$25K

Financing is provided by third parties who are not affiliates of AutoZone. All of the advertised loan programs, rates, terms and conditions are subject to change at any time without notice. An extra charge may be imposed at the end of the lease depending on the residual value of the leased goods.

For All of Your Tool, Equipment and Shop Supply Needs,
Call 1-877-AZTOOL1 (1-877-298-6651) or Email Us at AZTOOL@AZTOOL1.com. (Hablamos Español)
Call Center Hours: Monday - Friday 7:00 a.m. to 5:00 p.m. CT

Tool & Equipment Offers the Best Brands in the Business.



Shop This Catalog or Call:
1-877-AZTool1
1-877-298-6651
(Hablamos Español)



FREE OVERNIGHT SHIPPING WITH MOST ORDERS

Free overnight shipping available to continental U.S. for qualifying VDP orders of 70 Lbs. or less. Free overnight shipping excludes: lift-gate fees, residential delivery, non-network carriers, and certain freight intensive items that are shipped FOB.

TOOLS AND EQUIPMENT IN THIS ISSUE:

A/C Hose and Line Repair	59	Oil Change	49-51
A/C Service Tools	58	Paint and Body	22, 104
Air Compressors	80-81	Parts Washers	74
Air Conditioning	54-59	Pliers	51, 60, 66-67, 69-71, 97-98, 102-104, 118
Air Tools and Accessories	82-84, 86	Power Tool Accessories	96
Air Hoses and Reels	85-86	Power Tools	92-95
Alignment	13-15, 21-23, 37-38	Pressure Washers	77
Apparel	117	Pullers	38, 48, 58, 62-65, 69, 71, 75, 104
Automotive Lifts	16-21, 23, 37	Recovery Machines	38, 54
Battery Service	40-44	Regulators/Filters/Drains	81
Body Repair	27, 104	Rivet Tools	71
Brake Lathes	46-47	Safety Supplies	115
Brake Service	46-48	Scan Tools	11, 31, 35-36, 45
Chassis/Suspension	62-63, 105	Screwdrivers	93, 95-99
Clearance	119	Service Tools	64-67
Cooling System	60-61	Shop Cooling and Fans	114
Creepers and Seats	28-29, 113	Shop Equipment	74-77
Diagnostics	30-37, 45	Shop Presses	75
Disconnect Tools	60, 66	Shop Stools	112
Drill Bits and Extractor Sets	72-73, 96	Shop Supplies	112-113, 115
Engine Service Tools	68-69	Socket Sets	12, 50-51, 62, 65, 68-69, 73, 84, 98-99, 101-102, 118
Engine Stands and Lifts	27	Specialty Tools	38, 70-71
Fans	114	Surface Prep	83-84
Floor Jacks	25-26	Thread Repair	72-73
Fluid Handling	52-53, 77	Tire and Wheel Service Combos	6-7
Generators	76	Tire Service	6-12, 21-22, 38
Gloves	116-117	Tire Service Tools	12
Hand Tools	97-103	Tool Organization	110-111
Hardware Kits	113	Tool Storage	106-109
Heating	5, 114	TPMS Tools	11, 30
Heavy Duty	36-39	Tubing	65, 85
Inflators	85-86	Uniforms	117
Jacks and Hydraulics	25-29	Vacuums	75
Jump Starters	40, 42-43, 119	Welding and Soldering	78-79
Leak Detection	38, 57-58	Wheel Weights	8
Lighting and Flashlights	24, 87-91, 119	Wrenches	65, 67, 97-98, 100, 103
New Items	4		

BRANDS IN THIS ISSUE:

AC Hydraulic	18, 25-27, 37	Forward Lift	13-14, 16-20	OTC	48, 62-64, 66, 68, 70, 72, 75, 102
Advanced Radiant Systems	5	Fountain Industries	74	Parts Brush Division	74
AirSept	55, 59	Fowler	67	Phoenix Systems	47
ALLDATA	45	G & G Technics	64, 71	Platt & LaBonia Co.	109
Atlas	21	Generac	76-77	Porto-Power	29
Ammco	46	Goodyear	85	Power Probe	32
Arrow Pneumatics	81	GreatLite	57, 87-89, 119	Powerbuilt	105
Associated	40-41	GreatNeck	93, 101, 103	Pro-Cut	47
ATEQ	11	Grip-On	112	QSP	15
Autel	30-32, 36, 48	Hardware Machinery	78-79, 113	QuickJack	19
Auto Meter	41	HECAT	60	Ranger	6, 8-9, 19, 26-27, 38, 46, 52, 74
BADA	8	Hein-Werner	29	Rapidair	85
Bartec USA	10-11, 41	Hillman	115	Red Kap	117
Baseline	6	Hofmann	6, 8, 10, 13-15, 38, 46	Redline	33, 38, 61
BendPak	13-14, 16-20, 37	Ingersoll Rand	80, 82-83, 85	Robinair	41, 54-55, 60
BigVac	75	Innova	35	Rotary	6, 14-16
Blackhawk	29	John Dow	26, 49, 52, 62, 73	SAS	115-117
Branick	10, 62	Knipex	100, 103	Schumacher	43, 91
BRM	48, 69	Kubota	75	Shark Industries	46, 74, 78, 84, 96, 104
Cal-Van	40, 60, 66, 71-72, 104	Lanair	5	Slip-N-Grip	112
CanDo	31, 34-36, 41	Launch	35	Smart-O	51
CEMB	6-7, 9, 13, 15, 38	Leak Finder	58	Stan Design	20
Challenger Lifts	14, 16-20, 37	Lincoln	49, 51-53, 74, 85	Steck	63, 71, 104, 112
CHAMPION	99-100, 103	Lisle	72, 84, 101-102, 104	Streamlight	87-88
CHANNEL LOCK	76	Livernois	68	Sure Shot	47
Chicago Pneumatic	80-81	Mahle	31, 37-38, 48, 54, 61, 77	Sylvania	24
CleanMaster	74	Makita	94, 96	Symtech	61
Coats	7, 9, 16-17, 19	Marson	71	TEXA	37
cps	54-56	Mastercool	54-59, 66	Thexton	27, 33, 58, 64
CTA	77	MaxxMarka	48, 61, 77	TMR/The Main Resource	10
Dannmar	116	Mechanix Wear	116	TPI	14, 38
CLC	12	Microflex	116	Tracerline	57-58
CTA	12	Midtronics	41	Trusty Cook Inc.	100
Dannmar	6, 14, 16-20, 85	Mighty Seven/M7	82	Tuxedo	22-23
DeWALT	95-96	Milton	84-85	UEI	34
Dorman	39	Mi-T-M	5, 77	Vaper	86
Drew Technologies	32	Mityvac	34, 47, 52, 64	ViperFlex	85
Duralast	83, 97, 104, 112, 120	MotorVac	68, 77	Water Works	74
ECCO	90	NES	72	X Force	81
EiKO	90	Noco	42	X-tra Seal	11
Electronic Specialties/ES	31, 33, 70	Noregon System	36		
EnergyLogic	5	OEMTOOLS	5, 10-12, 24-27, 31-34, 38, 40-42, 47-53, 55-75, 78-85, 87-89, 92-93, 96, 98-108, 110-117		
Ernst Manufacturing	111	Omega Lift Equipment	20, 28		
EZRED	87, 110				
Firepower	78-79				
FIX-A-THREAD	72				

NEW ITEMS

Lighting

Slim Folding Rechargeable Work Light

SKU 081750 26028 **39⁹⁹**

- COB Super Bright Work Light – 350 Lumens
- Max Output: 350 Lumens/175 Lumens
- Function: Low-High-OFF
- Run Time: 2 Hrs. (350 Lumens), 4 Hrs. (175 Lumens)
- Head Swivels 180° and Adjustable 360°
- Beam Distance: 85 Ft.
- Water Proof : IPX4
- Charge Time: 4 Hrs.
- Lightweight: 0.5 Lbs. (Including Battery)



Adjustable Illumination at any Angle



Powerful Magnetic Base Puts Light Where You Need It

2-in-1 Rechargeable Pocket Light

SKU 081751 26029 **29⁹⁹**

- 2-in-1 Pocket Light: Super Bright COB LED Work Light with Integrated LED Flashlight
- Convenient Pocket Clip Rotates 120° for Adjustable Illumination
- Easy Hands-Free Operation with Magnetic Base and Magnetic Pocket Clip
- Max Output (Work Light): 200 Lumens
- Max Output (Flashlight): 140 Lumens

OEM TOOLS™

- Run Time: 3 Hrs.
- Charge Time: 3 Hrs.
- Lightweight: 0.25 Lbs.
- Cordless and Rechargeable (50 cm USB Cable Included)



See Lighting, page 87

Engine Service Tools

BC 180SC Flex-Hone Tool Kit

SKU OUTSIDE BUY/EPO BRM14353 **169⁹⁹**

- 10 Piece Kit Features Flex-Hone Sizes: 10 mm, 1/2", 5/8", 3/4", 7/8", 1", 1-1/4", 1-1/2", 1-3/4" and 2"
- Complimentary Snap Back Hat, 1/2 Pint of Flex-Hone Oil, and 1 GB Flash Drive



See Engine Service Tools, page 69

Tool Organization

Pro Magnetic Wrench Organizer

- Organize up to 12 Wrenches
- Non-marring Foam Backing

OEM TOOLS™

Strong Magnets will Hold Organizer Upright at Full Capacity

Green
SKU OUTSIDE BUY/EPO 22177 **12⁹⁹**

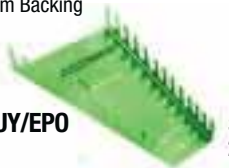

Black
SKU OUTSIDE BUY/EPO 22176 **12⁹⁹**

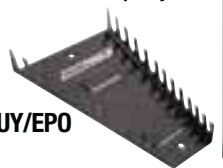

Tools Not Included

See Tool Organization, page 110

Engine Service

Manifold Drill Template - Ford 2V and 3V

SKU OUTSIDE BUY/EPO 25251 **69⁹⁹**

- Designed to Remove Broken Exhaust Manifold Studs
- For Ford Triton 2V and 3V Engines - 4.6L, 5.4L and 6.8L V10
- Interchangeable 2V and 3V Adapters
- Hi-Vis EVA Tray for Easy Storage and Organization



Available via Outside Buy/EPO, Call 1-877-298-6651 for Ordering Instructions

Ford Cam Phaser Noise Repair Kit 4.6/5.4 3V

SKU 494959 LMEF1503V **699⁹⁹**

- Prevents and Corrects Common Failure Point in 2004-2014 4.6 and 5.4 3V V8 Ford Vehicles
- Eliminates Cam Phaser Knock
- Simple in Design and Requires No Special Tools to Install
- Included Wedge Tool Simplifies Phaser Removal and Securely Holds Chains in Position
- Simple to Operate Tuner with OBD-II Cable Included
- *CARB E.O. Pending*



See Engine Service, page 68

Diagnostics

C-Pro 8" Tablet Scan Tool with Bluetooth & WiFi

SKU 201992 CDOC-PRO **899⁹⁹**

- Professional Scan Tool for Asian, European and Domestic Passenger Cars and Light Trucks
- Full System and Subsystem Access for Read & Clear Codes, Live Data, Bi-directional Controls and Special Functions
- Complete Factory Resets and Adaptations
- Bluetooth Android Tablet
- Remote Technician Function
- 1 Year Software Subscription



See Diagnostics, page 30

Tire Service

SM628BPS Forte Tire Changer with Bead Press System

SKU 081201 CMBSM628BPS **7,469⁹⁹**

- Self-Centering Turntable
- Easily Changes Aftermarket Custom Wheels
- Heavy-Duty 220V Motor with High Torque, Handles the Most Difficult Sidewall Tires and Deep Drop Center Rims
- Two Stage Tire Bead Sealing Inflation Jets with Safety Limiter
- Plug & Play with On-Site Training

CEMB USA
WHEEL SERVICE EQUIPMENT



INCLUDES:
Set-Up and Training

Lift Gate Service

SKU 765535 CMBLIFTGATE **60⁰⁰**

WARRANTY: 2 Year Parts and 1 Year Labor

1/2" Drive 17 mm Mercedes Flower Lug Bolt Impact Socket

SKU 081308 24469 **15⁹⁹**

- Designed Specifically for 17 mm, Convex "Flower" Shaped Mercedes Lug Bolts
- Non-marring Protective Sleeve Helps to Prevent Scratching Wheel Finish
- Made from Durable, Impact Rated Chromoly Steel
- 1/2" Square Drive Can Be Used with Hand, Electric or Air Tools

OEM TOOLS™



Tire Repair and Road Emergency Set

SKU 081337 26680 **39⁹⁹**

- Easily Repair Punctured Tubeless Tires on Most Vehicles without Removing the Tire from the Rim
- Tire Repair Kit Includes: (30) 4" String Repair Plugs, Rasp Tool, Insert Needle Tool, (2) Hex Keys, Sealing Lubricant and Blow Mold Storage Case
- 4-in-1 Tire Gauge Features a Tire Gauge, Tire Deflator, Rescue Hammer and Seat-Belt Cutter
- Tire Gauge Measuring Ranges: 0-150PSI, 0-10BAR, 0-100KPA and 0-10Kg/cm²
- Backlit LCD Display and Lighted Nozzle for Use in Low-Light Settings

OEM TOOLS™



SHOP SUPPLY of the MONTH
MARCH
SEE INSERT FOR DETAILS

TS460BDII TPMS Diagnostic Tool

SKU OUTSIDE BUY/EPO ATETS460BDII **899⁹⁹**

- Programs All Leading Universal Aftermarket Sensors
- Easy to Operate Icon Interface and Bright Color Display
- Activates and Reads TPMS Sensors of All Light Vehicle Brands Globally
- Displays All Sensor Data in Seconds: ID, Tire Pressure, Tire Temperature, Battery Status, etc.
- Provides Comprehensive Indirect, Manual and Auto Relearn Procedure Information in 23 Languages
- OBDII Relearns for 60% of All Car Models Worldwide
- Select Vehicles via Make, Model, Year Look-Up



Available via Outside Buy/EPO, Call 1-877-298-6651 for Ordering Instructions

See Tire Service, page 11

Battery Service

Boost Ultra 1800 Peak Amp Jump Starter

SKU 081209 CAL590 **259⁹⁹**

- 12V Vehicle Jump Starter and Back-Up Charger for Portable Electronics
- 800 Cranking Amps and 1800 Peak Amps
- 30,000 mAh High Capacity Li-ion Battery with Fast Charging with Low Self-Discharge Cycle
- Includes Intelli-Clamps for Jumpstarting with Built-in Safety and Diagnostic Features



See Battery Service, page 40

HEATING

877-AZTool1
877-298-6651
 Hablamos Español
AZtool1.com

Shop Heaters

OEM TOOLS™

1500W 120V Shop Heater

SKU 814316 **99⁹⁹**
 24823

- Stainless Steel Heating Element
- Adjustable Thermostat
- Auto-reset Overheat Protection
- Durable, Rust Resistant Powder Coating
- Fan Mode
- Carry Handle and 6' Cord
- 120V Input



4800W 240V Wall Mount Heater

SKU 814134 **159⁹⁹**
 24824

- Stainless Steel Heating Element
- Wireless Remote Control
- Auto-Reset Overheat Protection
- Adjustable Thermostat with LED Display
- Timer Mode 1-9 Hours
- Fan Only Mode
- Durable, Rust Resistant Powder Coated Finish
- Convenient Handle with Built-in Cord Storage
- Includes Wall/Ceiling Mounted Bracket
- 208-240V Input Power



40-60K BTU Liquid Propane Heater

SKU 814143 **169⁹⁹**
 24822

- Adjustable Heating Output from 40-60K BTU
- Built-in Overheating Protection
- 115V AC Power Input for Multi Purpose Use
- Piezo Igniter
- Adjustable Angle Base
- Operates on Liquid Propane Gas
- Includes Regulator and 10' Hose



EnergyLogic Waste Oil Heaters

Stop hauling off your used oil. Burn waste oil for FREE heat this winter.

COMPLETE SYSTEMS (includes furnace, tank and flue kit)

			250 GALLON TANK		
FURNACE	BTUs	HEATS UP TO	SKU	PART NO.	PRICE
EL-140	140,000	3,500 Sq. Ft.	850048	ENL01140103	7,769.99
EL-200	200,000	5,000 Sq. Ft.	850047	ENL01200104	8,919.99
EL-350	350,000	8,500 Sq. Ft.	850049	ENL01350104	10,569.99

*Includes Waste Oil Furnace and 250 Gallon Tank, Swing-Away Burner with Built-in Air Compressor, Low-fuel Cut Off, Draft Gauge, Fuel Gauge, Drain Valve and Class A Flue Kit. Also available with 130 and 200 gallon tank.

- Lower Energy Costs
- Onboard Air Compressor
- Burn No.2 to 90W and synthetics
- Hotter Flame with double the heat rise
- No Manual Adjustments Needed



Call Us Today for Sizing Help

Kerosene Heaters

75,000 BTU Kerosene Forced Air Heater

SKU 546639 **389⁹⁹**
 MTMMH0075M10

Heats 1,700 Sq. Ft. up to 8.9 Hours

WHILE SUPPLIES LAST



135,000 BTU Kerosene Forced Air Heater

SKU 546641 **519⁹⁹**
 MTMMH0135M10

Heats 3,100 Sq. Ft. up to 10 Hours

WHILE SUPPLIES LAST



190,000 BTU Kerosene Forced Air Heater

SKU 546640 **564⁹⁹**
 MTMMH0190M10

Heats 4,300 Sq. Ft. up to 9.1 Hours

WHILE SUPPLIES LAST



Model Number	Heat Output	Hot-Air Flow	Air Pump Pressure	AC Power	Motor Size	Fuel Tank Capacity	Fuel Consumption	Max. Operating Hours	Heating Area	Multi-Fuel Capable	Digital Temp. Read-Out	Error Indicator Read-Out	Parts Storage System	Dimensions (LxWxH)	Ship Wt.	Net Wt.
MTMMH0075M10	75,000 BTU	240 CFM	4.0 PSI	120V, 60Hz, 1.5 Amps	1/8 HP	5.0 Gal.	0.56 Gal./Hr.	8.9 Hours	1,700 Sq. Ft.	Yes	No	No	No	30x13x15 In.	33 Lbs.	28 Lbs.
MTMMH0135M10	135,000 BTU	540 CFM	5.0 PSI	120V, 60Hz, 2.3 Amps	1/5 HP	10.0 Gal.	1.00 Gal./Hr.	10.0 Hours	3,100 Sq. Ft.	Yes	Yes	Yes	Yes	37x22x25 In.	57 Lbs.	51 Lbs.
MTMMH0190M10	190,000 BTU	630 CFM	7.5 PSI	120V, 60Hz, 2.7 Amps	1/4 HP	13.0 Gal.	1.42 Gal./Hr.	9.1 Hours	4,300 Sq. Ft.	Yes	Yes	Yes	Yes	42x24x26 In.	65 Lbs.	58 Lbs.

Mi-T-M Kerosene-Fired Forced Air Heaters are Portable, Easy to Operate and Extend Heat Into Wide Areas Creating a Comfortable Work Environment Even in the Harshest Conditions

Shop Heaters

Value Package C Thru-Roof Chimney

150,000 BTU SKU 988908 **7,009⁹⁹**
 LAN9963C MODEL MX150C

- Heats Up to 3,500 Sq. Ft.

200,000 BTU SKU 988916 **7,309⁹⁹**
 LAN9964C MODEL MX200C

- Heats Up to 5,000 Sq. Ft.

250,000 BTU SKU 988923 **8,399⁹⁹**
 LAN9965C MODEL MX250C

- Heats Up to 8,500 Sq. Ft.

300,000 BTU SKU 988926 **8,844⁹⁹**
 LAN9966C MODEL MX300C

- Heats Up to 10,000 Sq. Ft.



Value Package D Thru-Wall Chimney

150,000 BTU SKU 988912 **7,249⁹⁹**
 LAN9963D MODEL MX150D

- Heats Up to 3,500 Sq. Ft.

200,000 BTU SKU 988918 **7,549⁹⁹**
 LAN9964D MODEL MX200D

- Heats Up to 5,000 Sq. Ft.

250,000 BTU SKU 988924 **8,624⁹⁹**
 LAN9965D MODEL MX250D

- Heats Up to 8,500 Sq. Ft.

300,000 BTU SKU 988893 **9,069⁹⁹**
 LAN9966D MODEL MX300D

- Heats Up to 10,000 Sq. Ft.

Free Delivery in 48 Continental United States. Leasing Terms Available Ask Your AutoZone® Commercial Sales Manager.



BONUS
 VALUE: \$119.99

Strainer Pan

With Purchase of:
 Lanair Value Package (C or D)

Offer Good Through
 March 31, 2019
 While Supplies Last



Quick snow melting & dryer floors!

RESIDENTIAL INFRARED HEATERS

- Rates 30,000 to 45,000 btu/hr
- Preassembled construction
- No loose parts
- Simplified installation
- Balanced flue construction
- Single exhaust penetration
- Low cost to install
- Costs 50% less to operate vs. forced air
- **Unpack, Hang, Connect**



30,000 btu/hr

Natural Gas ARSRS30NA
 SKU 434710

1,399⁹⁹

Propane ARSRS30LPG
 SKU 750500

45,000 btu/hr

Natural Gas ARSRS45NA
 SKU 750594

1,399⁹⁹

Propane ARSRS45LPG
 SKU 750587



approx length: 119in
 weight: 150lbs

TIRE SERVICE

SAVE \$2,669.99 ON HOFMANN COMBO, SEE BELOW

SAVE ON COMBO OFFERS!

T-100 Tire Changer and B-100 Wheel Balancer Combo

SKU 818788
DAN1381801 **3,444⁹⁹**

- Includes: DAN1381201 Dannmar T-100 Tire Changer and DAN1381202 Dannmar B-100 Wheel Balancer
- Ideal for Gas Stations, Small Garages and Auto Salvage Yards
- T-100 – Outside Clamp: 12" - 22"
- B-100 – Max. Rim Diameter: 28"
- B-100 Includes Data Acquisition Wand and Quick Nut

Lift Gate Service

SKU 262534
DANLIFTGATE **100⁰⁰**

The T-100 B-100 Combo Provides Great Value and More Bang for Your Buck!



DAN1381201



DAN1381202

SAVE \$434⁹⁹

DAN1381801	T-100 Tire Changer and B-100 Wheel Balancer Combo	
DAN1381202	Dannmar T-100 Tire Changer	\$2,039.99
DAN1381201	Dannmar B-100 Digital Balancer	\$1,839.99
	Regular Price	\$3,879.98
DAN1381801	COMBO PRICE	\$3,444.99
	SAVINGS	\$434.99

WARRANTY: 90 Days Parts and Labor; User Set-Up Required
Price does not include tires or rims as shown

BL300 Tire Changer and 350 Balancer Combo

SKU 435488
AMM8500300350 (shown) **3,999⁹⁹**

- Includes: BL300 Tire Changer and 350 Balancer
- External Clamping Capacity: 10 - 24"
- Bead Sealing Jets to Aid Inflation
- 350 Balancer Features Self Diagnosis and Calibration
- One Button Split and Hidden Weight Program

500 Tire Changer and 550 Balancer Combo

SKU 435489
AMM8500500550 **5,199⁹⁹**

- Includes: 500 Tire Changer and 550 Balancer
- 10-24" External Clamping Capacity
- Bead Sealing Jets to Aid Inflation
- 550 Balancer Features Automatic Distance and Diameter Entry
- Direct Weight Location

Lift Gate Service

SKU 262529
AMMLIFTGATE **55⁰⁰**

WARRANTY: 1 Year Parts Only

SAVE \$399⁹⁹



AMM8500300350

COMBOS INCLUDE: Manufacturer's Set-Up

AMM8500300350	BaseLine™ BL300 Tire Changer and 350 Balancer Combo	
AMM85002300	BL300 Tire Changer	\$2,099.99
AMM85002350	BL350 Wheel Balancer	\$2,099.99
	Regular Price	\$4,199.98
AMM8500300350	COMBO PRICE	\$3,999.99
	SAVINGS	\$199.99

AMM8500500550	BaseLine™ 500 Tire Changer and 550 Balancer Combo	
AMM85002500	BL500 Tire Changer	\$2,799.99
AMM85002550	BL550 Wheel Balancer	\$2,799.99
	Regular Price	\$5,599.98
AMM8500500550	COMBO PRICE	\$5,199.99
	SAVINGS	\$399.99

Tire Service Package

SKU 851131
RANCOMB01 **4,499⁹⁹**

- Includes: R980XR NEXTGEN™ Swing-Arm 30" Tire Changer and the DST-2420 Dynamic Wheel Balancer
- R980XR External Rim Clamping Capacity: 9" - 28", Internal Clamping 10"-30"
- 3-Position RimGuard™ Wheel Clamps
- DST-2420 Dynamic Wheel Balancer Dependably Ensures an Accurate Result within Hundredths of an Ounce

Lift Gate Service

SKU 262533
RANLIFTGATE **95⁰⁰**

INCLUDES: 74³⁸ Value Wheel Weight Starter Kit #5150235, 100-Piece Silver Roll and 100-Piece Black Roll



RANDST420



RANR980XR

SAVE \$189⁹⁹

RANCOMB01	Ranger® Tire Service Package	
RANDST420	DST-2420 Tire Balancer	\$2,099.99
RANR980XR	NEXTGEN 23" Tire Changer	\$2,589.99
	Regular Price	\$4,689.98
RANCOMB01	COMBO PRICE	\$4,499.99
	SAVINGS	\$189.99

WARRANTY: 1 Year Parts and 1 Year Labor
User Set-Up Required
Price does not include tires or rims as shown

geodyna® 7100 Balancer and monty® 1270 Tire Service Combo

SKU 339014
HOFCOMB01TS **4,529⁹⁹**

- Save with This Great General Service Tire Service Combo
- Includes monty 1270 Tire Changer with Outer Clamping Up to 20" and the geodyna 7100 Wheel Balancer with Belt-Driven One-Spin Balance and Intuitive Control Panel

Lift Gate Service

SKU 290017
HOFLIFTGATE **95⁰⁰**

SAVE \$2,669⁹⁹



HOFEEWB761AE1



HOFEEWH764AU1

HOFCOMB01TS	geodyna® 7100 Balancer and monty® 1270 Tire Service Combo	
HOFEEWH764AU1	monty 1270 Tire Changer	\$3,599.99
HOFEEWB761AE1	geodyna 7100 Wheel Balancer	\$3,599.99
	Regular Price	\$7,199.98
HOFCOMB01TS	COMBO PRICE	\$4,529.99
	SAVINGS	\$2,669.99

WARRANTY: 90 Days Parts and 90 Days Labor; User Set-Up Required
Price does not include tires or rims as shown

R140i and R138 Tire Service Combo

SKU OUTSIDE BUY/EPO
ROTCOMB01 **4,999⁹⁹**

- Includes: R140i Tire Changer and R138 Balancer
- High Quality Swing Arm Changer and 2D Balancer at an Economical Price
- Changer Offers 22" Outside and 24" Inside Clamping with Tire Diameters Up to 40"
- Balancer Features Auto Start, Digital Display, and Hidden Weight Program
- 110V Single Speed Motor

Lift Gate Service Included

WARRANTY: 2 Years Parts and 1 Year Labor

INCLUDES: Manufacturer's Set-Up and Training



ROTR138



ROTR140i

SAVE \$299⁹⁹

ROTCOMB01	Rotary R140i Tire Changer and R138 Wheel Balancer	
ROTR140i	R140i Tire Changer	\$3,019.99
ROTR138	R138 Wheel Balancer	\$2,279.99
	Regular Price	\$5,299.98
ROTCOMB01	COMBO PRICE	\$4,999.99
	SAVINGS	\$299.99

Available via Outside Buy/EPO, Call 1-877-298-6651 for Ordering Instructions

EZ9 Balancer and SM825 Tire Changer Combo

SKU OUTSIDE BUY/EPO
CMBCOMB01 **5,999⁹⁹**

- Includes: EZ9 Balancer and SM825 Tire Changer
- Tire Changer Clamping Range of 13"-26"
- Dual Clamping Cylinders
- Semi-Automatic Swing Arm
- Adjustable Bead Breaker
- Balancer Features Automatic Distance and Diameter Entry
- Direct Weight Location
- Foot Pedal Brake for Easy Weight Placement

Lift Gate Service

SKU 765535
CMBLIFTGATE **60⁰⁰**

INCLUDES: Manufacturer's Set-Up



CMBEZ9



CMBSM825

CMBCOMB01	CEMB EZ9 Balancer and SM825 Tire Changer Combo	
CMBEZ9	CEMB EZ9 Wheel Balancer	\$3,289.99
CMBSM825	CEMB SM825 Tire Changer	\$2,999.99
	Regular Price	\$6,289.98
CMBCOMB01	COMBO PRICE	\$5,999.99
	SAVINGS	\$289.99

Available via Outside Buy/EPO, Call 1-877-298-6651 for Ordering Instructions
Price does not include tires or rims as shown

TIRE AND WHEEL SERVICE COMBOS

Coats® RC-55E and 1300 Series Tire Service Combo

SKU 597289
 AMMCOMB02 **9,999⁹⁹**

- RC-55E Features an External Clamping Range from 6" to 24" (Max Tire Diameter 50"; Max Rim Width 10-1/2")
- RC-55E Drive System: 1 HP Electric Motor
- Tire Changer Allows Inflation from 0 to 60 PSI with a Built-in Pressure Limiter
- 1300 Series Wheel Balancer is Powered By Direct Drive
- Static-On-Screen® Display Identifies Any Excess Residual Static Imbalance
- Wheel Balancer Automatically Enters 2-D Data for Wheel Diameter and Offset Measurement

Lift Gate Service

SKU 262529
 AMMLIFTGATE **55⁰⁰**

INCLUDES:
 Manufacturer's Set-Up and Training

AMM80013002D



COATS



AMM8560995001

AMMCOMB02	Coats® RC-55E and 1300 Series Tire Service Combo	
AMM8560995001	RC-55E Tire Changer	\$5,919.99
AMM80013002D	1300 2D Wheel Balancer	\$4,479.99
	Regular Price	\$10,399.98
AMMCOMB02	COMBO PRICE	\$9,999.99
	SAVINGS	\$399.99

Price does not include tires or rims as shown

Coats 8001 and 16003D Series Tire Service Combo

SKU OUTSIDE BUY/EPO
 AMMCOMB03 **17,699⁹⁹**

- Touchscreen Display
- Automatic 3D Technology
- Rim Diameter 6 - 24" Clamping
- Hand Activated Bead Loosener
- Premium Accessory Kit

Lift Gate Service

SKU 262529
 AMMLIFTGATE **55⁰⁰**

INCLUDES:
 Manufacturer's Set-Up and Training

AMM80016003D



COATS



AMM80070XEH3

AMMCOMB03	Coats® 8001 and 16003D Series Tire Service Combo	
AMM80070XEH3	70X Electric Tire Changer	\$8,699.99
AMM80016003D	1600 Direct Drive Balancer	\$9,429.99
	Regular Price	\$18,129.98
AMMCOMB03	COMBO PRICE	\$17,699.99
	SAVINGS	\$429.99

Available via Outside Buy/EPO
 Call 1-877-298-6651 for Ordering Instructions
 Price does not include tires or rims as shown

CEMB Wheel Balancers

EZ9 Digital Automatic Wheel Balancer

SKU 221532
 CMBEZ9 **3,289⁹⁹**

- Space Saving Motorized Wheel Balancer
- For Cars and Light Trucks, Motorcycle and Scooter Wheels (with Optional Accessories)
- Automatic Distance and Diameter Entry (2D)
- Direct Weight Location Program (No Repositioning of Stick-On Weight)
- Multi-Function Display
- Split Program to Hide the Counterweight Behind the Spokes
- Foot Pedal Brake for Easy Weight Placement
- Splash Guard



WARRANTY: 5 Year Motor, 2 Year Parts, 1 Year Labor; Set-Up and Training Included
 Price does not include tires or rims as shown

ER72 Professional Wheel Balancer

SKU 762510
 CMBER72 **6,019⁹⁹**

- Touch Screen Professional Wheel Balancer Designed for Tire Dealers
- Standard Locking with Quick-Nut
- Automatic Distance and Diameter Entry
- Fully Automatic Spotter Laser System
- Electromagnetic Brake Holds the Wheel in Position
- Automatic Arm to Measure Diameters Up to 30"
- LED to Illuminate the Workspace Inside the Rim



WARRANTY: 5 Year Motor, 2 Year Parts, 1 Year Labor; Set-Up and Training Included
 Price does not include tires or rims as shown

ER75MC HubMatch™ Manual Clamping Diagnostic Wheel Balancer

SKU 751691
 CMBER75MC **9,249⁹⁹**

- The Fastest, Easiest To Use and Best Performing RFV Balancer at a Fraction of the Cost of Other RFV Balancers
- Manual Locking
- Measures Wheel Balance and RFV in 6 Seconds
- Direct Measure Automatic 3D Data Entry, 3D Laser Wheel Scanning and Laser Point BDC Weight Placement
- Hubmatch™ Balancing Clocks the RFV High Point of the Assembly to the Vehicle Hub Before Mounting. Virtually Eliminates Match Mounting on Today's Improved-Quality Tires and Wheels



HubMatch™ ER75 Video Diagnostic Wheel Balancer

SKU 765534
 CMBER75 **12,439⁹⁹**

WARRANTY: 5 Year Motor, 2 Year Parts, 1 Year Labor; Set-Up and Training Included
 Price does not include tires or rims as shown

Lift Gate Service SKU 765535 | CMBLIFTGATE **60⁰⁰**

Coats Wheel Balancers

1300 2D Wheel Balancer

SKU 592250
 AMM80013002D **4,479⁹⁹**

- Auto Distance and Diameter Data Entry
- Behind the Spoke Mode
- 40 mm Shaft Diameter
- Maximum Tire Diameter: 44"
- 220V, 1 Phase



INCLUDES:
 Manufacturer's Set-Up

WARRANTY: 1 Year Parts and 6 Months Labor
 Price does not include tires or rims as shown

1500A 3D Wheel Balancer

SKU 339012
 AMM80015003D **7,529⁹⁹**

- Powered By Direct Drive
- Includes Premium Quicknut
- Automatic 3-D Data Entry
- Basic Adapter Kit Included
- Collet Adapters



INCLUDES:
 Manufacturer's Set-Up

WARRANTY: 1 Year Parts and 6 Months Labor
 Price does not include tires or rims as shown

1600A 3D Wheel Balancer

SKU 082860
 AMM80016003D **9,429⁹⁹**

- Powered By Direct Drive
- ProBalance Technology™
- Premium Quicknut
- Stop, Lock and Index
- 8 Balancing Modes
- Automatic 3-D Data Entry
- Basic Adapter Kit Included



INCLUDES:
 Manufacturer's Set-Up

WARRANTY: 1 Year Parts and 6 Months Labor
 Price does not include tires or rims as shown

Lift Gate Service SKU 262529 | AMMLIFTGATE **55⁰⁰**

DON'T FORGET THESE ACCESSORIES

• Works with Coats Wheel Balancers Listed on This Page



Adjustable Pin Plate Set **1,599⁹⁹**
 SKU 818762 | AMM85610104



40 mm Light Truck Cone **309⁹⁹**
 SKU 212844 | AMM8113277C

TIRE SERVICE

Hofmann Wheel Balancers

geodyna® 7200S Wheel Balancer

SKU 306300
HOFEWB746AS **4,399⁹⁹**

- Small Footprint Complemented By the Video Display Provides High-End Features in a Compact Design
- In Under 10 Seconds, the Color Display Shows the Location of Any Imbalance
- Split Weight Mode Hides Adhesive Weights Behind Adjacent Spokes



INCLUDES: On-Site Factory Authorized Training

INCLUDES: 4-Piece Cone Kit #HOFEAK0309J28A **134³⁸ Value**

WARRANTY: 5 Year Motor, 3 Year Electronic Circuit Board, 1 Year Standard Parts, 6 Months Labor
Price does not include tires or rims as shown

geodyna® 7340L

SKU 082921
HOFEWB774AE8 **5,669⁹⁹**

- Intuitive geoTouch™ Technology Built into the Weight Tray to Provide an Ergonomic Solution
- easyWeight™ Indicator Light is a Fast and Easy Solution to Position Weights on the Wheel
- smartSonar™ Automatically Detects Rim Width for Greater Accuracy and a 30% Savings Compared to Manual Operation
- Premium Wheel Balancer in a Compact Design
- QuickBAL™ Technology Reduces Cycle Time to Less Than 4.5 Seconds
- Max. Wheel Diameter: 42"
- Max. Wheel Width: 20"



INCLUDES: On-Site Factory Authorized Training

INCLUDES: 4-Piece Cone Kit #HOFEAK0309J28A **134³⁸ Value**

WARRANTY: 5 Year Motor, 3 Year Electronic Circuit Board, 1 Year Standard Parts, 6 Months Labor
Price does not include tires or rims as shown

geodyna® 7340P Wheel Balancer

SKU 202347
HOFEWB774APE **6,189⁹⁹**

- Easy-to-Operate, Intuitive GeoTouch Technology is Built into the Weight Tray and Provides an Ergonomic Solution
- Smart Sonar™ Delivers Automatic, Non-Contact Rim Width Acquisition
- Patented Power Clamp Electromechanically Clamps the Wheel Accurately with a Constant Force Reducing the Opportunity for Chasing Weight



INCLUDES: On-Site Factory Authorized Training

INCLUDES: 4-Piece Cone Kit #HOFEAK0309J28A **134³⁸ Value**

WARRANTY: 5 Year Motor, 3 Year Electronic Circuit Board, 1 Year Standard Parts, 6 Months Labor
Price does not include tires or rims as shown

geodyna® 7800

SKU 082917
HOFEWB753BE8 **8,019⁹⁹**

- Fully Automatic Parameter Entry Completely Eliminates the Need for the Operator to Enter Any Data - Just Close the Hood and Go
- Automatic Power Clamp Ensures Consistent Balance on All Wheels
- easyWeight Indicator Light is a Fast and Easy Solution to Position Weights on the Wheel
- smartSonar Automatically Detects Rim Width
- QUICKBAL Technology Reduces Cycle Time to Less Than 4.5 Seconds
- LED Wheel Lighting Automatically Floods the Wheel with Light to Assist the Operator



INCLUDES: On-Site Factory Authorized Training

INCLUDES: 4-Piece Cone Kit #HOFEAK0309J28A **134³⁸ Value**

WARRANTY: 5 Year Motor, 3 Year Electronic Circuit Board, 1 Year Standard Parts, 6 Months Labor
Price does not include tires or rims as shown

Lift Gate Service SKU 290017 | HOFLIFTGATE **95⁰⁰**

Ranger Wheel Balancers

Digital Wheel Balancer

SKU 977528
RANDST2420 **2,099⁹⁹**

- Motor: 1.5 HP, 110V / 220V, 50 / 60 Hz, 1Ph
- Balancing Modes: Dynamic / Static / 3-Alloy
- Quick - Release Hub Nut for Dramatically Reduced Set-up Times
- Ounce / Gram Selection
- Max. Tire Diameter 47" / 1,194 mm
- Max. Tire Weight: 145 Lbs.
- Balancing Speed: 180 RPM
- Balance Increments: 0.25 or 0.01 Oz.
- Accuracy: +/- 1 gram / .035 Oz.



WARRANTY: 1 Year Parts and 1 Year Labor
User Setup Required
Price does not include tires or rims as shown

DST-30P Direct Drive Wheel Balancer

SKU 949577
RANDST-30P **2,259⁹⁹**

- Ergonomic Control Board and Easy-to-Read LED Display
- Dynamic, Static, and Performance Alloy Settings
- Automatic Rolling Wheel Parameter Setting
- Low RPM Balancing Speed
- Automatic Braking
- Motor: 1.5 HP, 110V / 220V, 50 / 60 Hz 1Ph
- Quick-Release Hub Nut for Dramatically Reduced Set-Up Times
- Wheel Width Capacity: 1.2" - 20"
- Max. Wheel Diameter: 8" - 30"



WARRANTY: 1 Year Parts and 1 Year Labor
User Setup Required
Price does not include tires or rims as shown

Lift Gate Service SKU 262533 | RANLIFTGATE **95⁰⁰**

DON'T FORGET THIS ACCESSORY

• Works with Ranger Wheel Balancers Listed on This Page



Truck Cone Kit

SKU 902536 RANRWS-1TC-1 **249⁹⁹**

Wheel Weights

Complete Wheel Weight Program Available!

Call 1-877-AZTool1 or go to AZTool1.com for More Styles and Information

Steel Wheel Weights

AZ NUMBER	SKU NUMBER	PART NUMBER	STYLE	QUANTITY	PRICE
382853	AMM025PFEPK4	PFE, 0.25 Oz.	4 Boxes of 25	25.99	
382919	AMM050PFEPK4	PFE, 0.50 Oz.	4 Boxes of 25	26.99	
382920	AMM075PFEPK4	PFE, 0.75 Oz.	4 Boxes of 25	31.99	
382921	AMM100PFEPK3	PFE, 1.00 Oz.	3 Boxes of 25	30.99	
382922	AMM125PFEPK3	PFE, 1.25 Oz.	3 Boxes of 25	34.99	
382923	AMM150PFEPK3	PFE, 1.50 Oz.	3 Boxes of 25	37.99	
382924	AMM175PFEPK3	PFE, 1.75 Oz.	3 Boxes of 25	41.99	
382925	AMM200PFEPK3	PFE, 2.00 Oz.	3 Boxes of 25	43.99	
382926	AMM225PFEPK2	PFE, 2.25 Oz.	2 Boxes of 25	32.99	
382927	AMM250PFEPK2	PFE, 2.50 Oz.	2 Boxes of 25	34.99	
382928	AMM275PFEPK2	PFE, 2.75 Oz.	2 Boxes of 25	35.99	
382841	AMM025MCFEPK4	MCFE, 0.25 Oz.	4 Boxes of 25	33.99	
382842	AMM050MCFEPK4	MCFE, 0.50 Oz.	4 Boxes of 25	37.99	
382843	AMM075MCFEPK4	MCFE, 0.75 Oz.	4 Boxes of 25	42.99	
382844	AMM100MCFEPK3	MCFE, 1.00 Oz.	3 Boxes of 25	36.99	
382845	AMM125MCFEPK3	MCFE, 1.25 Oz.	3 Boxes of 25	42.99	
382846	AMM150MCFEPK2	MCFE, 1.50 Oz.	2 Boxes of 25	33.99	
383004	AMM025TFEPK4	TFE, 0.25 Oz.	4 Boxes of 25	33.99	
383005	AMM050TFEPK3	TFE, 0.50 Oz.	3 Boxes of 25	30.99	
383021	AMM025ALFEPK4	ALFE, 0.25 Oz.	4 Boxes of 25	33.99	
383022	AMM050ALFEPK4	ALFE, 0.50 Oz.	4 Boxes of 25	37.99	
383129	AMM025LHFEK3	LHFE, 0.25 Oz.	3 Boxes of 25	28.99	
383130	AMM050LHFEK3	LHFE, 0.50 Oz.	3 Boxes of 25	30.99	
383038	AMM10GFNFEK3	FNFE, 10g	3 Boxes of 25	31.99	
383039	AMM15GFNFEK3	FNFE, 15g	3 Boxes of 25	33.99	
383107	AMM10GENFEK4	ENFE, 10g	4 Boxes of 25	37.99	
383108	AMM15GENFEK4	ENFE, 15g	4 Boxes of 25	41.99	
383118	AMM10GIWFEK4	IWFE, 10g	4 Boxes of 25	37.99	
383119	AMM15GIWFEK3	IWFE, 15g	3 Boxes of 25	33.99	

Wheel Weight Profile



Tape-A-Weight® Steel Wheel Weight

AZ NUMBER	PART NUMBER	SIZE (OUNCES)	QUANTITY	PRICE
019312	AMM5533601025	0.25	10 Lbs. Roll	39.99
019310	AMM5533701050	0.50	10 Lbs. Roll	69.99
019304	AMM5533600300	0.25	40 Strips - 12 Segments Each	54.99
019294	AMM5533700500	0.50	24 Strips - 10 Segments Each	69.99
019301	AMM5533800700	1.00	16 Strips - 7 Segments Each	69.99

Tape-A-Weight® Roll Dispenser

SKU 019292
AMM5310025

149⁹⁹

Stand Only, Weights Not Included



Metal Floor Rack with 1,700 Steel Weight Assortment

SKU 383179
AMM5202075 **649⁹⁹**

- Steel Rack, Application Chart, Header Card, Channel Cards, Rim Gauge, Premium Wheel Weight Hammer, Tape-A-Weight Scraper, 8 Styles of Wheel Weights: MCFE, ALFE, PFE, TFE, IWFE, FNFE, LHFE and INFE

Weight Replenishment Kit For 5202075 Steel

SKU 383180
AMM5202080 **449⁹⁹**

Bench Top Rack with 1,000 Coated Steel Weight Assortment

SKU 383181
AMM5202125 **499⁹⁹**

- Louvered Rack Can Be Placed on Top of Any Work Bench
- Includes: Steel Rack, Application Guide, Header Card, Bin Labels, Rim Gauge, Wheel Weight Hammer, (5) Style Wheel Weights: PFE, ALFE, MCFE, TFE, FNFE, (40) Plastic Bins: (8) of Each: Yellow, Gray, Black, Red and Orange



Weight Replenishment Kit For 5202125 Steel

SKU 382825
AMM5202130 **299⁹⁹**



FREE OVERNIGHT SHIPPING
WITH MOST ORDERS
SEE PAGE 3 FOR DETAILS

CEMB Tire Changers

SM825BPS Swing & Press Arm Tire Changer

SKU 081202
CMBSM825BPS **4,399⁹⁹**

- Dual Table Clamping Cylinders with 13"-26" Wheel Clamping Range
- Maximum Tire Diameter 47" and Maximum Tire Width 15"
- Dual Stage Inflation System with Safety Limiter and Bead Blaster Built into the Clamping Jaws
- Powerful and Adjustable Bead Breaker Shovel Loosens the Most Difficult Tires and Wheels
- Plug & Play with On-Site Training
- Press Arm and Bead Pressing Tool



INCLUDES:
Set-Up and Training

WARRANTY: 2 Year Parts and 1 Year Labor

SM628BPS Forte Tire Changer with Bead Press System

SKU 081201
CMBSM628BPS **7,469⁹⁹**

NEW

- Self-Centering Turntable
- Easily Changes Aftermarket Custom Wheels
- Heavy-Duty 220V Motor with High Torque, Handles the Most Difficult Sidewall Tires and Deep Drop Center Rims
- Two Stage Tire Bead Sealing Inflation Jets with Safety Limiter
- Plug & Play with On-Site Training



INCLUDES:
Set-Up and Training

WARRANTY: 2 Year Parts and 1 Year Labor

SM1100BPS VersaSwift Tire Changer with Bead Press System

SKU OUTSIDE BUY/EPO
CMBSM1100BPS **14,849⁹⁹**

NEW

- Leverless Mount/Demount Head Provides Simple Finger Tip Activated Demounting of Ultra-High Performance, Stiff Sidewall Tires
- Heavy-Duty 220V Motor with High Torque, Handles the Most Difficult Sidewall Tires and Deep Drop Center Rims
- Two Bead Loosening Systems: a Horizontal Mounted Bead Loosener for High Performance Tires or a Side Mounted Bead Breaker for Traditional Soft Sidewall
- Top-Down Handheld Bead Sealing Blaster Included Standard
- UHP Press Arm System is a Must Have for Simple Servicing of Stiff Sidewall Tires and Deep Drop Center Rims
- Plug & Play with On-Site Training



INCLUDES:
Set-Up and Training

WARRANTY: 2 Year Parts and 1 Year Labor
User Set-Up Required

Available via Outside Buy/EPO, Call 1-877-298-6651 for Ordering Instructions

Lift Gate Service SKU 765535 | CMBLIFTGATE **60⁰⁰**

Coats Tire Changers

RC-45E Rim Clamp Tire Changer

SKU 688225 (Electric)
AMM8560994901 **4,539⁹⁹**

- External Rim Clamping Range: 6" - 24"
- Maximum Rim Width: 10.5"
- Maximum Tire Diameter: 50"
- Includes Bead Sealing Jet to Aid Inflation



WARRANTY: 1 Year Parts and 6 Months Labor

INCLUDES:
Manufacturer's Set-Up

RC-55E Rim Clamp Tire Changer

SKU 688223
AMM8560995001 **5,919⁹⁹**

- Robo-Arm® Power Assist for Low Profile and Run-Flat Tires
- External Rim Clamping Range from 6" - 24" Diameter
- Maximum Rim Width 10.5"
- Maximum Tire Diameter 50"
- Electric Turntable



WARRANTY: 1 Year Parts and 6 Months Labor

Price does not include tires or rims as shown

INCLUDES:
Manufacturer's Set-Up

60X Rim Clamp Tire Changer

SKU 298103
AMM80060XEH1 **7,409⁹⁹**

- Rim Diameter: 6 - 24" External
- Patented Robo-Arm® Helper Device
- Hand Activated Bead Loosener
- Single Point Sealer



WARRANTY: 3 Years Parts and 6 Months Labor

Price does not include tires or rims as shown

INCLUDES:
Manufacturer's Set-Up

70X, Electric, Hand, Premium Accessory Kit

SKU 979908
AMM80070XEH3 **8,699⁹⁹**

- Rim Diameter: 6 - 24" External
- Patented Robo-Arm® Helper Device
- Hand Activated Bead Loosener
- Single Point Sealer



WARRANTY: 3 Years Parts and 6 Months Labor

INCLUDES:
Manufacturer's Set-Up

Grip Max Plus Adjustable Clamps

SKU 012699
AMM85607986

639⁹⁹

- 16" - 28" External Clamping
- Updated Jaw Profile Accommodates Newer Rim Flange Profiles
- Wider Grip Contact Area and New Material Further Reduce Slip on Polished Surfaces

Lift Gate Service SKU 262529 | AMMLIFTGATE **55⁰⁰**

Ranger Tire Changers

R76LT Tilt-Back Tire Changer

SKU 544546
RANR76LT **2,519⁹⁹**

- Drive System Type: Electric / Air
- Motor: 2 HP (110/220VAC / 50 - 60 Hz)
- 3-Position RimGuard™ Wheel Clamps
- External Rim Clamping Capacity: 9" - 28"
- Internal Rim Clamping Capacity: 10" - 30"
- Bead Breaking System: Pneumatic Blade
- Tower Design Tilt Back
- Max Tire Diameter: 43"



WARRANTY: 1 Year Parts and 1 Year Labor

User Set-Up Required

R980XR NextGen™ Swing-Arm Tire Changer

SKU 312817
RANR980XR **2,589⁹⁹**

- Drive System Type: Electric / Air
- Motor: 2 HP (110/208 - 240VAC 50-60 Hz)
- Adjustable RimGuard™ Wheel Clamps
- Internal Rim Clamping Capacity: 10" - 30"
- External Rim Clamping Capacity: 9" - 28"
- Bead Seating System: Turbo Blast / Bead Seating
- Dual Position RimGuard™ Wheel Clamps



WARRANTY: 1 Year Parts and 1 Year Labor

User Set-Up Required

R980AT RimGuard™ Swing-Arm and Assist Tower Tire Changer

SKU 544537
RANR980AT **3,749⁹⁹**

- Motor: 2 HP (110/208-240V, 50-60 Hz)
- External Rim Clamping Capacity: 9" - 28"
- Internal Rim Clamping Capacity: 10" - 30"
- Maximum Tire Diameter 50"
- Power Assist Tower Left Side



WARRANTY: 1 Year Parts and 1 Year Labor

User Set-Up Required
Price does not include tires or rims as shown

R76ATR Tilt-Back Tire Changer with Assist Tower

SKU 544543
RANR76ATR **4,089⁹⁹**

- Motor: 2 HP 110 / 208 - 240VAC, 50-60 Hz
- Alloy and Nylon Mount and Demount Heads
- External Rim Clamping Capacity: 9" - 28"
- Internal Rim Clamping Capacity: 10" - 30"
- Maximum Tire Diameter 43"
- Traveling Drop-Center Tool
- Power Assist Tower Right Side"



WARRANTY: 1 Year Parts and 1 Year Labor

User Set-Up Required

Lift Gate Service SKU 262533 | RANLIFTGATE **95⁰⁰**

• Free Delivery in 48 Continental United States • Specifications Subject to Change without Notice or Liability. Prices Do Not Include Vehicles, Installation or Optional Equipment as Shown. • Customers Responsible for Off-Loading Equipment Upon Arrival. Ask Your Customer Sales Rep for Details. • Leasing Terms Available.† Ask Your AutoZone® Commercial Sales Manager.

TIRE SERVICE

Hofmann Tire Changers

monty® 1625 with smartSpeed™

SKU 949550
HOFEEWH748B **6,799⁹⁹**

- Patented smartSpeed™ Technology
- Accommodates Large Wheel & Tire Assemblies
- Dual Wheel Clamping Cylinders
- Four-Jaw Clamping Chuck
- Multi-Position Bead Breaker
- Powerful Tire Inflation System
- Clamping Range 10"-26"



WARRANTY:
5 Year Transmission,
3 Year Motor,
1 Year Standard Parts,
6 Months Labor

Price does not include tires
or rims as shown

INCLUDES:
On-Site Factory Authorized Training

monty® 8100S smartSpeed Tire Changer

SKU OUTSIDE BUY/EPO
HOFEEWH768AC **8,429⁹⁹**

- smartSpeed™ Technology That Automatically Controls Turntable Speed and Torque to Minimize Tire and Wheel Damage
- Ergonomic Hand Operated Bead Breaker Simplifies Demount Process
- Modern Center Post Design Ensures Damage Free, Non-Slip Wheel Mounting
- Swing Arm Style Mount/Demount with a Quick-Change Design
- Integrated Wheel Lift Simplifies Wheel Mounting and Minimizes Operator Fatigue
- Unique Pedestal Mounting with Swing Arm Configuration
- Max. Tire Diameter: 44"; Width: 15"
- Max. Rim Width: 14"; Rim Diameter: 12" - 30"
- Shown with Optional Bead Assist



WARRANTY: 5 Year Transmission, 3 Year Motor, 1 Year Standard Parts, 6 Months Labor
Price does not include tires or rims as shown

Available via Outside Buy/EPO,
Call 1-877-298-6651 for Ordering Instructions

INCLUDES:
On-Site Factory Authorized Training



monty® 3550EM Tire Changer with smartSpeed™

SKU OUTSIDE BUY/EPO
HOFEEWH747B **9,409⁹⁹**

- Patented smartSpeed™ Technology - Variable from 7 RPM to 18 RPM
- Push-Button Controlled Mount/Demount Head Pneumatically Lowers and Locks into Position, Automatically Indexing Away from the Wheel to Prevent Contact and Damage
- Pneumatic Vertical Arm Automatically Re-Positions the Mounting Head to Minimize Wheel Damage
- High Capacity Tire Changer Allows for Broadest Tire and Wheel Assembly Coverage
- Clamping Range: Inside 12" - 28"; Outside 12" - 26"
- Max. Tire Diameter: 47"
- Max. Tire Width: 17"



WARRANTY: 5 Year Transmission, 3 Year Motor, 1 Year Standard Parts, 6 Months Labor

Available via Outside Buy/EPO,
Call 1-877-298-6651 for Ordering Instructions

INCLUDES:
On-Site Factory Authorized Training

Lift Gate Service SKU 290017 | HOFLLIFTGATE **95⁰⁰**

Mount / Demount Heads

Fits On **Models**

Red Nylon Mount/Demount Head

SKU 459185
TMRTC343 **29⁹⁹**



Hunter TC250, TC300, TC325, TC350, TC2000, TC3250, TC3500, TC3000 and TC3100 Series

Accuturn (Require Adapter) 220A, All Other Models Require 102765 Adapter

Ranger R980X Rev A Models, R980XR/NXT, R30XLT, RX-850/950-B Models, R23/23ST, R26ST/26EX, R745 and R710 Models ONLY. Require RAN5150524 Adapter

Nylon Mount/Demount Head - Tapered Hole

SKU 459183
TMRTC183061 **29⁹⁹**



Coats 5030, 5035, 5040, 5045, 5050, 5060, 5065, 6050, 6060, 7050, 7055, 7060, 7065, 7655, 7660 and 7665

Baseline BL200, BL300, BL400 and BL500

Low Profile Mount/Demount Head

SKU 557259
TMRTC184432 **44⁹⁹**



Coats Replacement for Coats 8184432. For use on Models RC100, RC150, RC200, 5030, 5035, 5040, 5045, 5050 Series, 5060 Series, 5065 Series, 6050, 6060, 6065, 7050, 7055, 7060, 7065, 7655, 7660, 7665, BL200, BL300, BL400, and BL500

Tool Head for Hunter

SKU 557241
TMRTC14120 **49⁹⁹**



Hunter TCA34 with Serial Numbers 664 and Above

Mounting Flange for Demount Head (Flange Only)*

SKU 899502
RAN5150524 **64⁹⁹**



Ranger All Models

Nylon Mount/Demount Head - Tapered Hole

SKU 459189
TMRTC450310 **69⁹⁹**



All Tool All Models

Coats RC1, 5, 10, 15, 20, Early 5060, 9010, 9024 and APX90

Corghi All Rim Clamp

Giuliano Shaft Needs to Be Turned 180 Degrees for This Head to Work

Hofmann Earlier Models Except 1550, 1620 and 1625

Hunter Fits All TCX Series (Earlier TCX500 Requires Upgrade Shaft and Kit RP11-8-114-00091)

Sice M39, S40, S41, S42, S43, S45, S408MAXI, S435, S436 and S436TOP

Nylon Mount/Demount Head - Tapered Hole

SKU 459174
TMRTC20024335 **69⁹⁹**



Accuturn 3602, 3602HP, 4260, 4560MR, 4602, 5602 and 5602 HP

Hofmann 1520, 1565, 1620, 1625EM, 3300, 3300EM, 1270, 2300, 3000 and 3000GP

John Bean EHP System IVE, IV, III, IIE

Snap On All Models

Nylon Mount/Demount Head Kit with Round Hole

SKU 459195
TMRTC14024784 **79⁹⁹**



Accuturn 3602, 3602HP, 4260, 4560MR, 4602, 5602 and 5602 HP

Hofmann 1520, 1565, 1620, 1625EM, 3300, 3300EM, 1270, 2300, 3000 and 3000GP

John Bean EHP System IVE, IV, III, IIE

Snap On All Models

Nylon Mount/Demount Head Kit with Round Hole

SKU 459187
TMRTC250309 **79⁹⁹**



All Tool All Models

Coats RC1, 5, 10, 15, 20, Early 5060, 9010, 9024 and APX90

Corghi All Rim Clamp

Hofmann Earlier Models Except 1550, 1620 and 1625

Sice M39, S40, S42, S43, S45, S408MAXI, S435, S436 and S436TC

Tire Spreader



Tilting Swivel Top Manual Tire Spreader

SKU 804480
26679 **199⁹⁹**

- 5 Position Locking Swivel Top
- Foot Operated Tilting Mechanism
- Adjustable Tire Spreaders
- Works with Most Passenger Car and Light Truck Tires



Horizontal Swivel Top Adjustment Knob

5025 Tire Spreader

SKU 757051
BRA00-0161 **349⁹⁹**

- Self-Locking Spread Arms
- 4 Horizontal and 2 Vertical Adjustments
- Handles Any Passenger Tire, Including Low Profiles
- Quick Pin Adjustment with Lanyard



Test Tank

Tire Tube Test Tank

SKU 291382
LIS19822 **69⁹⁹**

- Tank Features Reinforcement Ribs for Extra Support
- Will Handle Passenger Tire Sizes to Wide Oval and Light Duty Truck Tires
- Dimensions: 31" (L) x 12" (W) x 12" (H)

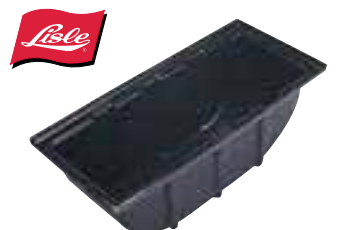

Tire Inspection Tool



SKU 938806
WRT200PRO **\$1,299⁹⁹**



Features REMOTE TDCIL SETUP!



Send the data wirelessly and create a report like this!



TPMS Tools

TPMS Service Tool with Tread Depth Gauge

SKU 544586 **1,249⁹⁹**
 ATEVT56

- 98% Coverage on Vehicles Equipped with TPMS
- Selects MMY via VIN Scan
- Comprehensive MMY Specific Re-Learn Procedures
- Programs and Decodes Programmable and Universal TPMS Sensors
- Built-in Training Procedures
- Includes 3 Year Free Updates

FUNCTIONALITY	VT56	TS460BDII	VT36
Reads/activates 100% OEM sensors, displays all sensor data	✓	✓	✓
Programs aftermarket sensors (including EZ sensor and all major brands)	✓	✓	✓
Manual ID for aftermarket sensors	✓	✓	✗
Retrieved OBDII ID's for cloning aftermarket sensors	✓	✓	✗
VIN barcode scanner to select Make-Model-Year	✓	✗	✗
Tire tread depth reader for complete TPMS service management	✓	✓	✗
Provides TPMS relearn procedures (including indirect/direct)	✓	✓	✗
Tests Remote Key Entry (RKE)	✓	✓	✓
Includes OBDII routines to reset the ECU in <2 min (OBD connectivity)	✓	✓	✗
Retrieves and decodes TPMS DTC information	✓	✗	✗
Training and vehicle help-tips for technicians	✓	✗	✗
Screen display	4.3" LCD Screen	2.8" LCD screen	2.8" Monochrome



VT36 TPMS Programming Tool

SKU 596887 **289⁹⁹**
 ATEVT36-0000

- Programs All Leading Aftermarket Programmable Sensors
- Reads and Activates TPMS Sensors
- Displays TPMS Sensor Data (ID, Tire Pressure, Tire Temperature, Battery Status, Frequency)
- Make, Model and Year Specific Re-Learn Procedures



TS460BDII TPMS Diagnostic Tool

SKU OUTSIDE BUY/EPO **899⁹⁹**
 ATETS460BDII

- Easy to Operate Icon Interface and Bright Color Display
- Activates and Reads TPMS Sensors of All Light Vehicle Brands Globally
- Programs All Leading Universal Aftermarket Sensors
- Displays All Sensor Data in Seconds: ID, Tire Pressure, Tire Temperature, Battery Status, etc.
- Provides Comprehensive Indirect, Manual and Auto Relearn Procedure Information in 23 Languages
- OBDII Relearns for 60% of All Car Models Worldwide
- Includes 5 Year Free Updates and 1 Year Warranty



Available via Outside Buy/EPO, Call 1-877-298-6651 for Ordering Instructions

Lug Wrenches

4-Way SAE and Metric Lug Nut Wrenches

- Socket Sizes: 11/16" (17 mm), 3/4" (19 mm), 13/16" (21 mm) and 7/8" (22 mm)
- Carbon Steel Construction

14" SKU 003478 **14⁹⁹** 20560
20" SKU 003879 **21⁹⁹** 20561



Price does not include vehicle or tires

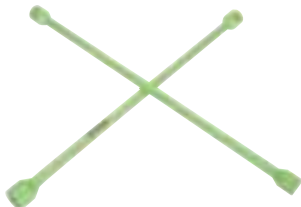

Telescoping Lug Nut Wrench and Sockets

SKU 912347 **24⁹⁹**
 33620564

- 1/2" Drive
- Includes 2 Double-ended Sockets: 17 mm (11/16") x 21 mm (3/4"), 21 mm (13/16") x 22 mm (7/8")
- Telescoping Handle Extends to 21" for Maximum Leverage
- Compacts to 14" for Convenient Storage

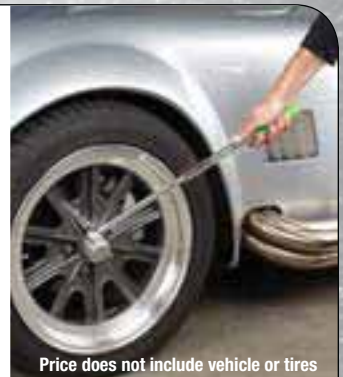

Price does not include vehicle or tires

25" SKU 004126 **24⁹⁹** REG. \$29.99 20562
SAVE \$5

- Socket Sizes: 7/8", 15/16", 1", 1-1/16"

Offer Good Through March 31, 2019 - While Supplies Last

14" 4-Way Folding Lug Nut Wrench

SKU 003459 **19⁹⁹** 20563

- Socket Sizes: 11/16" (17 mm), 3/4" (19 mm), 13/16" (21 mm), and 7/8" (22 mm)
- Heavy Duty, Drop-Forged Steel
- Chrome Plated to Resist Corrosion
- Folds for Compact Storage



Price does not include vehicle or tires

Power Cross 26" Lug Nut Wrench

SKU 082938 **29⁹⁹**
 33620565

- Multiple Configurations Provide More Leverage and Twice the Torque of a Standard Lug Nut Wrench
- Conveniently Collapses to 17" (L) x 1" (W) for Storage
- Socket Sizes: 11/16" (17 mm), 3/4" (19 mm), 13/16" (21 mm)
- Includes 1/2" Square Drive with Removable 7/8" (22 mm) 1/2" Drive Socket

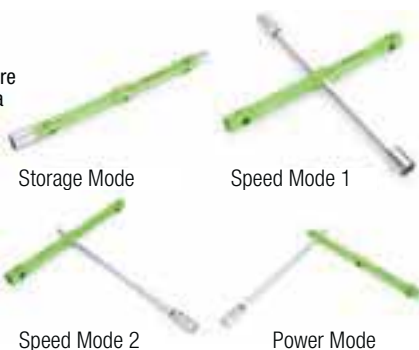

Price does not include vehicle or tires

Tire Service Supplies

We Have a Full Assortment of Repair Supplies.

Available via Outside Buy/EPO, Contact Us 1-877-AZTOOL1

11" Cotton Tire Swab

XTS14-378 **4⁹⁹**



Tire Patch Stitcher

XTS14-314 **8⁹⁹**



8 Oz. Vulcanizing Cement

XTS14-008 **7⁹⁹**



1 Gallon Tire Lube

XTS14-753PM **11⁹⁹**



32 Oz. Bead Sealer

XTS14-101 **12⁹⁹**



Premium Repair Kit

XTS12-353 **54⁹⁹**



Tire Repair and Road Emergency Set

SKU 081337 **39⁹⁹** 26680

- Easily Repair Punctured Tubeless Tires on Most Vehicles without Removing the Tire from the Rim
- Tire Repair Kit Includes: (30) 4" String Repair Plugs, Rasp Tool, Insert Needle Tool, (2) Hex Keys, Sealing Lubricant and Blow Mold Storage Case
- 4-in-1 Tire Gauge Features a Tire Gauge, Tire Deflator, Rescue Hammer and Seat-Belt Cutter
- Tire Gauge Measuring Ranges: 0-150PSI, 0-10BAR, 0-100KPA and 0-10Kg/cm²
- Backlit LCD Display and Lighted Nozzle for Use in Low-Light Settings



SHOP SUPPLY of the MONTH **MARCH** SEE INSERT FOR DETAILS

Tire Dollies

Tire Transport Dolly

SKU 919498 **84⁹⁹** 24864

- For Efficient, 1-Person Transport of Car, Light Truck and SUV Tires and Wheel Assemblies
- Features (2) 3" Swivel Casters and (2) 3" Locking Casters
- Stackable Design for Easy Storage
- Dimensions: 25.19" (L) x 25.19" (W) x 6.89" (H)



Tire Transport Dolly with Extensions

SKU 912349 **139⁹⁹** 24865

- Includes Removable Height Extensions
- Weight Capacity: 330 Lbs.
- Dimensions: 25.19" (L) x 25.19" (W) x 21.45" (H)



Features (2) 3" Swivel Casters and (2) 3" Locking Casters

The Premier TPMS Tool that combines speed with accuracy!

TECH 400 PRO TPMS Scan Tool

- ✓ Easy to Operate
- ✓ More OBD Relearns
- ✓ More Fault Code Detection
- ✓ Wireless Updating
- ✓ TPMS Placard Adjusting
- ✓ Wireless Inductive Charging
- ✓ Passive Key System testing
- ✓ TIA Inside Technology
- ✓ Sensor Programming
- ✓ Works with Point of Sale systems!

1,699⁹⁹

SKU 760944 WRT400PRO



Best COVERAGE available in a TPMS Tool!

THREE TIME INDUSTRY WINNER



BARTEC USA

TIRE SERVICE

Tire Service Tools

1/2" Drive 17mm Mercedes-Benz® Flower Lug Bolt Impact Socket

SKU 081308
24469 **15⁹⁹**

- Non-marring Protective Sleeve Helps to Prevent Scratching Wheel Finish
- Made from Durable, Impact Rated Chromoly Steel
- 1/2" Square Drive Can Be Used with Hand, Electric or Air Tools
- Designed Specifically for 17mm, Convex "Flower" Shaped Mercedes Lug Bolts



OEM TOOLS™

NEW

3 Piece Super Strength Wheel Nut Impact Socket Set

SKU 347212
24227 **39⁹⁹**

- Color Coded for Easy Size Identification
- Blue - 17 mm
- Gold - 19 mm
- Red - 21 mm

LASTS
3X
LONGER

Than Standard
Thin Wall Sockets



3 Piece, Extra Thin Wall, Wheel/Nut Protector Impact Socket Set

SKU 094646
25583 **24⁹⁹**

- 17 mm / 11/16" - Blue
- 19 mm / 3/4" - Yellow
- 21 mm / 13/16" - Red



9 Piece, Thin Wall, Wheel Protector Impact Socket Set

SKU 965856
24224 **79⁹⁹**

- Hard Plastic Sleeve and Insert Protects Expensive Wheels and Lug Nuts from Damage
- Sizes: 3/4", 7/8", 13/16", 15/16", 1", 1-1/16", 17 mm, 19 mm and 21 mm



8 Piece Wheel Stud Alignment Guide Kit

SKU 818715
24233 **39⁹⁹**

- Makes the Job Faster and Easier Allowing the Tech to Safely Position the Wheel Prior to Installing the Wheel Bolts
- Applications: Mercedes-Benz, BMW, Audi, VW, Porsche, Fiat and Dodge
- Sizes Included: 12 mm x 1.5, 12 mm x 1.25, 14 mm x 1.25 and 14 mm x 1.75
- Includes Blow Mold Case



Air Tire Buffer

SKU 802218
24410 **74⁹⁹**

- Recommended Air Pressure: 90 PSI
- Air Consumption: 3.5 CFM
- Free Speed: 2,600 RPM
- Air Inlet Thread Size: 1/4" NPT
- Minimum Hose Size: 3/8"



2 Piece Valve Core Tool Set

SKU 255622
VCTSET **14⁹⁹**

- For Inserting or Removing Valve Cores
- Ergonomic Shaped Handles That Provide Firm Grip
- Includes 2" and 4" Tools



Wheel Weight Hammer Tool

SKU 217378
25690 **22⁹⁹**

- Tool Installs, Removes, Trims and Tightens All Types of Clip-On Wheel Weights
- Features a Special Plastic Material on Hammer Head for Safe, Mar-Free Installation of Specially Coated Wheel Weights Used on Alloy Wheels



Spare Tire Removal Set

SKU 749919
24219 **69⁹⁹**

- 32" Reach Allows Access to Spare Tires Stored on the Undercarriage of Pickups, Vans and SUVs
- Includes: (6) Zinc-Plated Steel Tools that Fit a Range of Vehicle Types, Hand Crank, and Heavy Duty Nylon Pouch
- No Additional Tools Needed

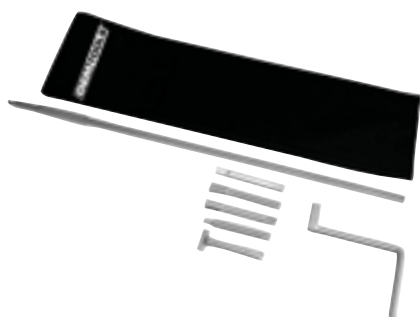

5 Gallon Bead Seater

SKU 526505
24449 **124⁹⁹**

- Seats Beads on All Tires, from Small 4" Tires to 24-1/2" Truck Tires
- Operates on Standard Shop Air, Max. 120 PSI



Lip on Barrel Allows for Proper Angle for Correct Bead Seating

SAVE \$14.99

When You Buy the Set

Wheel Stud Installer Set for Cars and Trucks

SKU 339125
24236 **24⁹⁹**



Wheel Stud Installer

SKU 339123
24234 **19⁹⁹**

- Works with Hubs, Rotors and Axles on Both Front and Rear Wheel Drive Vehicles
- Prevents Damage to Lug Nut or New Stud
- Designed to Fit Studs Up to 14 mm or 9/16"



Truck Wheel Stud Installer

SKU 339117
24235 **19⁹⁹**

- Designed to Work on Truck Wheel Studs Up to 22 mm (7/8") in Diameter
- Use with an Impact Wrench or Ratchet



Price does not include wheel bearing as shown

16 Piece Locking Lug Master Key Set

SKU 626107
24447 **79⁹⁹**

- Easily Removes Locking Lug Nuts on Most Aftermarket Wheels
- Thin Wall Sockets Prevent Damaging Wheels and Lugs
- Double Hex-Head Design Fits Most Lug Wrenches as Well as 13/16" and 7/8" Sockets
- Chart Included



Individual Sizes Available on AZTOOL1.COM

9 Piece Wheel Lock Removal Impact Socket Set - 1/2" Drive

SKU 965865
24225 **49⁹⁹**

- Includes: GM Hubcap Lock Remover, GM Sprocket Hubcap Remover, Ford and Chrysler Hubcap Lock Remover, Large Universal Locking Lug Nut Remover, Large Wheel Cover Lock Remover, Remover for Stripped 18 mm Lug Nuts, GM "M" and "F" Body



4 Piece, Deep Thin Wall, SAE and Metric Impact Flip Socket Set

SKU 965857
24223 **24⁹⁹**

- Includes 3/4" - 13/16", 19 mm - 21 mm and 7/8" - 15/16" Sockets and 3" Extension



5 Piece Torque Limiting Extension Set

SKU 965858
24220 **79⁹⁹**

- Quick, Simple and Accurate
- Helps Prevent Lug Stud/Nut Damage and Warped Rotors
- Includes 1/2" Drive Extensions: 65 Ft/Lbs., 80 Ft/Lbs., 100 Ft/Lbs., 120 Ft/Lbs. and 140 Ft/Lbs.



8 Piece Torque Limiting Extension and Thin Wall Socket Set

SKU 347217
24228 **64⁹⁹**

- (4) Extension Bars: 65 Ft/Lbs. (90 Nm), 90 Ft/Lbs. (120 Nm), 100 Ft/Lbs. (135 Nm) and 110 Ft/Lbs. (150 Nm)
- (4) Deep Sockets: 17, 19, 21 and 22 mm



10 Piece Torque Limiting Socket Set - 1/2" Drive

SKU 965855
24221 **199⁹⁹**

- Prevents Under and Over Torquing
- Includes: 17 mm x 55 Ft/Lbs. 17 mm x 80 Ft/Lbs. 21 mm x 80 Ft/Lbs. 19 mm - 3/4" x 100 Ft/Lbs. 19 mm - 3/4" x 65 Ft/Lbs. 19 mm - 3/4" x 80 Ft/Lbs. 22 mm - 7/8" x 120 Ft/Lbs. 22 mm - 7/8" x 140 Ft/Lbs.



Lug Nut Sockets

Lug Nut Flip Sockets Two Hex Sizes in One Socket

SKU # 663554
A168 **9⁹⁹**

- 19 mm x 21 mm

SKU # 193837
4217 **12⁹⁹**

- 22 mm x 24 mm

SKU # 193854
4221 **11⁹⁹**

- 18.5 mm x 19.5 mm

SKU # 193858
4222 **11⁹⁹**

- 22 mm x 22.5 mm



STORE STOCKED

ALIGNMENT COMBOS

877-AZTool1
877-298-6651
 Hablamos Español
AZtool1.com

DON'T SEE A COMBO THAT SUITS YOUR NEEDS OR BUDGET? WE OFFER A FULL LINE OF PRODUCTS FROM THESE BRANDS



Lead Times Can Vary On Alignment Equipment

CALL US! 877-AZTOOL (877-298-6651) Hablamos Español

SAVE OVER \$500

CEMB DWA1000XL w/10,000 Lbs. 2 Post Lift

SKU OUTSIDE BUY/EPO ALIGNCOMB015 **13,999⁹⁹**

• Do You Want to Quickly and Economically Get into the Alignment Business? We've Combined the Easy to Use and Economical CEMB DWA1000XLK CCD Alignment System with the Reliable Forward 110 2-Post Lift for a Space and Money Saving Deal that Can't Be Beat! This System Includes the Aligner, Lift, Stands, Roller and Plates for a Complete Alignment System at Nearly Half the Cost of Most Alignment Packages.

• Package Includes: CMBDWA1000XLK Alignment System and FORI10 10,000 Lbs. Lift
 • Alignment System Includes Setup, Training and Support

Lift Gate Service

SKU 765535 CMBLIFTGATE **60⁰⁰**



CMBDWA1000XLK



FORI10

FORI10	10,000 Lb 2 Post Lift	\$3,109.99
CMBDWA1000XLK	CEMB 2 Post Alignment Kit	\$11,399.99
	Regular Price	\$14,509.98
ALIGNCOMB015	COMBO PRICE	\$13,999.99
	SAVINGS	\$509.99

Advertising Banner Included



Available via Outside Buy/EPO, Call 1-877-298-6651 for Ordering Instructions
 Price does not include vehicles, installation or optional equipment as shown

SAVE OVER \$700

CEMB DWA4000 Aligner Combo w/9,000 Lbs. Lift

SKU OUTSIDE BUY/EPO ALIGNCOMB013 **23,459⁹⁹**

• This Combo Package Puts You in the Alignment Business with High Quality CEMB and BendPak Products at a Great Low Price. The HD-9AE Four-Post Alignment Lift Provides 9,000 Lbs. of Lifting Capacity to Accommodate a Variety of Light Duty Trucks and Automobiles, and the CEMB DWA4000 Features a Camera Boom that Automatically Adjusts to Lift Height, User Friendly Software, and a 24" Monitor with Printer for Fast and Efficient Measuring and Analysis.

• Combo Includes: Aligner, Lift, 2 Rolling Jacks and Air Line Kit
 • Aligner Includes Setup and Training

Lift Gate Service

SKU 765535 CMBLIFTGATE **60⁰⁰**



CMBDWA4000



BENHD-9AE



BENRBJ4500



BENRBJ4500



BEN5174009

Advertising Banner Included



Available via Outside Buy/EPO, Call 1-877-298-6651 for Ordering Instructions
 Price does not include vehicles, installation or optional equipment as shown

BENHD-9AE	9,000 Lb Capacity Alignment Lift	\$5,169.99
CMBDWA4000	DWA4000 Alignment System	\$15,859.99
BENRBJ4500	4,500 Lb Rolling Bridge Jack	\$1,439.99
BENRBJ4500	4,500 Lb Rolling Bridge Jack	\$1,439.99
BEN5174009	Air Line Kit	\$269.99
	Regular Price	\$24,179.95
ALIGNCOMB013	COMBO PRICE	\$23,459.99
	SAVINGS	\$719.96

SAVE OVER \$850

geoliner® 650 XD Aligner Combo w/14,000 Lbs. Extended Length Lift

SKU OUTSIDE BUY/EPO ALIGNCOMB011 **27,299⁹⁹**

• The Latest Imaging Technology from Hofmann's geoliner® 650 XD Combined with BendPak's Legendary HDS14LSXE Makes for a Package that Delivers Beyond Your Expectations in Performance at a Price Much Less Than Expected. Designed into Every HD-Series Lift is a Laundry List of Key Features to Ensure that BendPak is the Absolute Best You Can Buy. The geoliner® 650 XD is Equipped with a Software Package Which Combines the Benefits of Camera Technology and Quality.

• Combo Includes: Aligner, Extended Lift, 2 Rolling Jacks and Air Line Kit
 • Hofmann Aligner Includes Setup and Training

Lift Gate Service

SKU 290017 HOFLIFTGATE **95⁰⁰**



HOFEWA712G



BENHDS14LSXE



BEN5174009

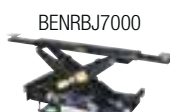

BENRBJ7000



BENRBJ7000

Available via Outside Buy/EPO, Call 1-877-298-6651 for Ordering Instructions
 Price does not include vehicles, installation or optional equipment as shown

BENHDS14LSXE	14,000 Lb Alignment Lift	\$7,829.99
HOFEWA712G	Hofmann geoliner® 650 XD	\$16,779.99
BENRBJ7000	7,000 Lb Rolling Bridge Jack	\$1,639.99
BENRBJ7000	7,000 Lb Rolling Bridge Jack	\$1,639.99
BEN5174009	Air Line Kit	\$269.99
	Regular Price	\$28,159.95
ALIGNCOMB011	COMBO PRICE	\$27,299.99
	SAVINGS	\$859.96

SAVE OVER \$550

geoliner® 670 XD Aligner Combo w/14,000 Lbs. Lift

SKU OUTSIDE BUY/EPO ALIGNCOMB05 **30,899⁹⁹**

• Combining the 670 XD Imaging Wheel Alignment System Along with the Forward CRA14 14,000 Lbs. 4-Post Alignment Lift Gets You Both the Latest Technology and Proven Durability. The geoliner® 670 XD Aligner Provides Patented Imaging Technology Along with Accurate and Real-Time Measurements While the Forward CRA14 14,000 Lbs. Alignment Lift with Concealed Cable and Pulley System and Multi-Position Lock Works as Both an Alignment and General Service Lift.

• Includes: Aligner, Steering Wheel Holder, Ride Height Target Kit, Brake Pedal Depressor, Remote Control, Color Inkjet Printer and Two Wheel Chocks, Alignment Lift, FLR (Filter, Lubricator, Regulator), (2) 7,000 Lbs. Capacity Rolling Jacks, Carbon Steel Front Radius Plates
 • Hofmann Aligner Includes Setup and Training

Lift Gate Service

SKU 290017 HOFLIFTGATE **95⁰⁰**



HOFEWA715H



FORCRA14



FORRRJ70G



FORRRJ70G

Available via Outside Buy/EPO, Call 1-877-298-6651 for Ordering Instructions
 Price does not include installation or optional equipment as shown

FORCRA14	Forward Lift 14,000 Lbs. 4 Post Alignment Lift	\$11,419.99
HOFEWA715H	Hofmann geoliner® 670XD	\$20,039.99
FORRRJ70G	7,000 Lbs. Rolling Bridge Jacks (Set of Two)	INCLUDED
	Air Line Kit	INCLUDED
	Turn Plates	INCLUDED
	Regular Price	\$31,459.98
ALIGNCOMB05	COMBO PRICE	\$30,899.99
	SAVINGS	\$559.99

ALIGNMENT

A FULL LINE OF ALIGNMENT LIFTS AVAILABLE FROM



Lead Times Can Vary On Alignment Equipment

Alignment Lifts

9,000 Lbs. 4 Post Alignment Lift

SKU 396661
BENHD-9AE **5,169⁹⁹**

- Designed to Accommodate a Variety of Light-Duty Trucks and Automobiles
- Features Adjustable Multi-Position Leveling, Integrated Front Radius Plates and Rear Slip Plates

Optional:
Rolling Bridge Jack
SKU 949556 | BENRBJ4500 **1,439⁹⁹**
Air Line Kit
SKU 531175 | BEN5174009 **269⁹⁹**



Price does not include vehicles, installation or optional equipment as shown

D-12/A™ 12,000 Lbs. Alignment Lift

SKU 579870
DAN1375682 **5,549⁹⁹**

- Compatible with All Leading Alignment Instrumentation, Including 3D and Camera Wheel Alignment Systems
- Multi Caster Slip Plates in the Rear Provide Precise Free Floating Movement
- Multiple Radius Plate Locations
- Turn Plates Included

Optional:
6K Bridge Jack
SKU 343411 **1,209⁹⁹**
DAN1375901
Air Line Kit Not Included

INCLUDES TURN PLATES & TWO ROLLING JACKS



WARRANTY: 3 Year Parts, Labor and Structure

Price does not include vehicles, installation or optional equipment as shown

Quatra™ 12,000 Lbs. Scissors Wheel Alignment Lift

SKU OUTSIDE BUY/EPO
BENXR12000A **17,949⁹⁹**

- Features a More Compact Footprint to Better Utilize Smaller Service Bays
- Accommodates a Variety of Wheelbases from Short Compacts to Extended Length Pickups and Work Trucks
- Includes Recessed Front Radius Plates and Oversized Rear Slip Plates

Optional:
Rolling Bridge Jack
SKU OUTSIDE BUY/EPO
BENRBJ6000 **1,489⁹⁹**
Air Line Kit
SKU 531175 **269⁹⁹**
BEN5174009



Available via Outside Buy/EPO,
Call 1-877-298-6651 for Ordering Instructions
Price does not include vehicles,
installation or optional equipment as shown

12,000 Lbs. Scissor Alignment Lift

SKU OUTSIDE BUY/EPO
HOFEELR709APK **17,579⁹⁹**

- Overall Width: 90"
- Overall Length: 267-3/8"
- Width Between Runways: 40"
- 4 Wheel Alignment Wheelbase: 89" to 158"
- 2 Wheel Alignment Wheelbase: Up to 165"
- Service Wheelbase: 179"
- Runway Surface Width: 23"
- Maximum Raised Height: 70" (178 cm)

INCLUDES AIR LINE KIT, TWO ROLLING JACKS, TURN PLATES AND ROLLOVER KIT



Available via Outside Buy/EPO,

Call 1-877-298-6651 for

Ordering Instructions

Price does not include installation or optional equipment as shown

14,000 Lbs. 4 Post Alignment Lift

SKU 898467
BENHDS14LSX **7,119⁹⁹**

- Adjustable Leveling, Integrated Front Radius Plates and Rear Slip Plates Makes Them Alignment Ready
- Compatible with All Leading Alignment Instrumentation, Including 3D and Camera Wheel Alignment Systems

14,000 Lbs. 4 Post Extended Alignment Lift

SKU 898468
BENHDS14LSXE **7,829⁹⁹**

- Features Extended Runways to Accommodate a Wide Variety of Vehicle Wheelbases
- Integrated Industrial Strength Slip Plates and Turn Plates to Maximize Alignment Convenience

Optional:
Rolling Bridge Jack
SKU 949548 | BENRBJ7000 **1,639⁹⁹**
Air Line Kit
SKU 531175 | BEN5174009 **269⁹⁹**



Price does not include vehicles, installation or optional equipment as shown

14,000 Lbs. 4 Post Open Front Alignment Lift

SKU OUTSIDE BUY/EPO
HOFEELR705A **21,999⁹⁹**

- Industry Leading 90" Long Rear Slip Plates to Accommodate Shorter and Longer Vehicles

INCLUDES AIR LINE KIT, TWO ROLLING JACKS*

*Turn plates not included

Premium Turn Plates (Set of Two)

SKU 467503 | HOFEAK0289J06 **1,299⁹⁹**

- Dimensions: 18.5" (L) x 19.7" (W) x 2" (H)



Available via Outside Buy/EPO,

Call 1-877-298-6651 for

Ordering Instructions

Price does not include installation or optional equipment as shown

14,000 Lbs. 4 Post Open Front Wheel Alignment Lift

SKU OUTSIDE BUY/EPO
ROTAR014-EL2 **19,914⁹⁹**

- Compatible with New Technology Alignment Systems
- Includes: (2) Stainless Steel Radius Gauges, (2) 7,000 Lbs. Capacity Rolling Jacks, 4WS Rear Slip Plates, Air Actuated Locking Latches, Portable Work Step and Internal Air Line Kit
- Level at All Locking Heights

WARRANTY: 12 Months Parts and 12 Months Labor

INCLUDES INTERNAL AIR LINE KIT, TURN PLATES & TWO ROLLING JACKS



Available via Outside Buy/EPO, Call 1-877-298-6651 for Ordering Instructions
Price does not include vehicles, installation or optional equipment as shown

14,000 Lbs. 4 Post Alignment Lift

SKU OUTSIDE BUY/EPO
FORCRA14 **11,419⁹⁹**

- Max Wheelbase: 182-1/2"
- Four Wheel Alignment: 89 - 1/4" to 156 - 3/4"
- Durable Cable and Sheave System
- Includes: (2) 7,000 Lbs. Capacity Rolling Jacks, Carbon Steel Front Turn Plates, Internal Air Line Kit

INCLUDES INTERNAL AIR LINE KIT, TURN PLATES & TWO ROLLING JACKS

WARRANTY: 18 Months Parts and 6 Months Labor

Available via Outside Buy/EPO, Call 1-877-298-6651 for Ordering Instructions
Price does not include vehicles, installation or optional equipment as shown



15,000 Lbs. Open-Front 4 Post Alignment Rack Package

SKU OUTSIDE BUY/EPO
CHLAR4015EAO **19,489⁹⁹**

- Package Includes:**
- (2) 7,500 Lbs. Rolling Jacks
 - Internal Air Line Kit
 - Stainless Steel Radius Gauges
 - Dual Rear Slip Plates
 - 20" Runway Width

INCLUDES INTERNAL AIR LINE KIT, TURN PLATES & TWO ROLLING JACKS

Available via Outside Buy/EPO, Call 1-877-298-6651 for Ordering Instructions
Price does not include installation or optional equipment as shown



Alignment Diagnostic

Groove Glove Handheld Laser Tire and Alignment Tool

SKU 757044
TPIGG001 **3,799⁹⁹**

- Groove Glove Provides Detailed Tire Tread Depth and Vehicle Alignment Recommendations from the Palm of Your Hand
- 4 Easy Steps Capture Vehicle Data and Provide an Easy-to-Understand Report
- Quickly Completes a Vehicle Scan Anywhere in the Service Facility, All You Need is a Wireless Signal
- Durable, Lightweight, Handheld and Wireless Communication
- Increase Tire Sales and Other Tire Related Services, Including Alignments and Tire Rotation
- Includes 2 Year Software and Spec Update Subscription



TreadSpec Drive Laser Tire and Alignment System

SKU OUTSIDE BUY/EPO
TPISD0001 **25,449⁹⁹**

- TreadSpec 2.0 Service Drive Automatically Captures Tire Tread Wear, Vehicle Alignment and Rotation Needs
- Zero Additional Labor Needed
- Increase Tire Sales or Other Around-the-Wheel Work, Including Alignments and Rotations
- TreadTracker™ Report Provides You the Selling Tool to Educate Your Customer and Build Trust
- Includes 2-Year Software and Spec Update Subscription



Available via Outside Buy/EPO,
Call 1-877-298-6651 for Ordering Instructions

• Free Delivery in 48 Continental United States • Specifications Subject to Change without Notice or Liability. Prices Do Not Include Vehicles, Installation or Optional Equipment as Shown.
• Customers Responsible for Off-Loading Equipment Upon Arrival. Ask Your Sales Rep for Details. • Leasing Terms Available.† Ask Your AutoZone® Commercial Sales Manager.



FREE OVERNIGHT SHIPPING
WITH MOST ORDERS
SEE PAGE 3 FOR DETAILS

Alignment Systems

**NEED AN ALIGNMENT SOLUTION
BUT DON'T HAVE THE BUDGET
OR SPACE FOR A 4 POST LIFT?**

**WE'VE GOT YOU COVERED WITH THE NEW
CEMB 2 POST ALIGNMENT KIT**

**DWA1000XLK Alignment Kit
for 2 Post Lift**

SKU OUTSIDE BUY/ EPO CMBDWA1000XLK **11,399⁹⁹**

**DWA1000XL 8 Camera CCD
Alignment System**

SKU 757116 CMBDWA1000XL **10,139⁹⁹**
(ALIGNER ONLY)

24" x 96" Banner Included



Lift Gate Service

SKU 765535 CMBLIFTGATE **60⁰⁰**

CMBDWA1000XLK KIT SHOWN

Available via Outside Buy/EPO,
Call 1-877-298-6651 for Ordering Instructions

**R1070 8-CCD Wheel
Alignment System**

SKU OUTSIDE BUY/EPO ROTR1070 **13,999⁹⁹**

- No Tower- Portable Console Positions Anywhere
- Infra-Red Transmissions Between Measuring Heads
- No Minimum Bay Size Required
- No Rollback Compensation
- Data Bank of More Than 90,000 Vehicle Data Sheets
- Lift Gate Included

WARRANTY: 2 Year Parts and 1 Year Labor

Set-Up and Training Included!



Available via Outside Buy/EPO,
Call 1-877-298-6651 for Ordering Instructions

**DWA4000 3D Wheel Alignment System
for Cars and Light Trucks**

SKU OUTSIDE BUY/EPO CMBDWA4000 **15,859⁹⁹**

- Measures All Required Alignment Specifications
- Targets with No Electronics and Batteries
- PC Computer and Storage Cabinet
- Windows® Operating System
- Brake Pedal Depressor and Steering Lock
- 24" TFT Monitor, Printer, Keyboard, Mouse
- Simple and User-Friendly Software

Lift Gate Service

SKU 765535 CMBLIFTGATE **60⁰⁰**

Available via Outside Buy/EPO,
Call 1-877-298-6651 for Ordering Instructions



Set-Up and Training Included!

24" x 96" Banner Included



**geoliner® 320 Portable Imaging
Wheel Aligner**

SKU OUTSIDE BUY/EPO HOFEEWA751H **14,629⁹⁹**

- Track Width: 48" - 96"
- Wheel Base: 79" - 180"
- Wheel Clamping Range: 11" - 24"
- True 3D On-the-Car Wheel Alignment Technology with (2) Rear Camera Pods with AC700 Wheel Clamps, (2) Front Targets with AC700 Wheel Clamps and (2) Lift-Mounted Reference Pods
- 3D Vehicle Measurement Provides Accurate and Live Alignment Adjustment, Full Vehicle Dimensions, and Easy Installation without Lift Calibration
- Graphics Display Provides All Relevant Data - Optimized for Visibility and Clarity
- Includes: Steering Wheel Holder, Brake Pedal Depressor, Wheel Chocks and Color Inkjet Printer

Lift Gate Service
SKU 290017 | HOFLIFTGATE **95⁰⁰**

Available via Outside Buy/EPO, Call 1-877-298-6651 for Ordering Instructions

Set-Up and Training Included!



geoliner® 660 Alignment System

SKU OUTSIDE BUY/EPO HOFEEWA712T **17,869⁹⁹**

- Digismart Automatic Vehicle Height Tracking
- All New User Interface with 3 Levels of Intervention – Compensate, Warn, Alert
- Wireless Remote Display Capabilities with Independent Navigation to Alignment Screens
- Advanced XD Cameras

Lift Gate Service
SKU 290017 | HOFLIFTGATE **95⁰⁰**

Available via Outside Buy/EPO,
Call 1-877-298-6651 for Ordering Instructions

Set-Up and Training Included!



**geoliner® 670 XD Imaging Wheel
Alignment System with AC400 Clamps**

SKU OUTSIDE BUY/EPO HOFEEWA715H **20,039⁹⁹**

- One of the Most Advanced Alignment Systems on the Market Today
- Patented Imaging Technology Provides Accurate and Real-time Measurements
- Smallest and Lightest Targets We've Ever Made
- Cross-diagonal Measurements Identify Frame or Structural Damage
- AC400 Clamps with XD Targets
- Measure Ride Height and Obtain Proper Alignment Specifications
- Step-by-step Instructions as a Guide for Completing Even the Most Complex Tasks
- Extensive OEM Specifications Allow Quick and Accurate Vehicle Selection

Lift Gate Service
SKU 290017 | HOFLIFTGATE **95⁰⁰**

Available via Outside Buy/EPO,
Call 1-877-298-6651 for Ordering Instructions

Set-Up and Training Included!



**geoliner® 770 Diagnostic Wheel
Alignment System with AC400
Wheel Clamps and XD Targets**

SKU OUTSIDE BUY/EPO HOFEEWA752BV **24,109⁹⁹**

- Ideal for High-Volume Shops That Specialize in Alignments
- Compact Footprint, Designed to Fit Where You Need It
- Wireless Communication: Navigate, Monitor and Control the Unit from Anywhere in the Shop
- VIN Code Reader
- Includes: Steering Wheel Holder, (2) Wheel Chocks, Brake Pedal Depressor, 24" Flat Panel Monitor, Color Inkjet Printer, AC400 Wheel Clamps with XD Targets

Lift Gate Service
SKU 290017 | HOFLIFTGATE **95⁰⁰**

Available via Outside Buy/EPO,
Call 1-877-298-6651 for Ordering Instructions

Set-Up and Training Included!



Alignment Accessories

**24" Alignment Wheel Stands with
Turn Plates and Slip Plates (Set of 4)**

SKU 463769 QSPDB-24MD **2,449⁹⁹**

- Turn Plates and Slip Plates Built Right into the Stands
- Four Adjustable Legs to Level the Four Stands Together
- 2,500 Lbs. Capacity per Plate



We Offer a Full Line of QSP USA-Made Products. Call 1-877-AZTool1 for Price, Specifications and Availability.

Rear Slip Plate Add-On Kit

SKU 463777 QSPDB-6000 **2,549⁹⁹**

- (2) 59-1/2" x 20" Full Floating Rear Slip Plates
- Simple Installation on Most General Service Lifts
- Length Options: 200" to 205", 186" to 196" and 173"
- Turn Plates Not Included



**Steering Wheel Holder
and Pedal Depressor Kit**

SKU 802195 24231 **64⁹⁹**

- Holds Steering Wheel in Position for Alignment Adjustments
- Depresses Brake Pedal for Various Brake Checks Including Brake Lamp Operation
- Simply Hand Squeeze the Actuator to Accomplish Fine Adjustments

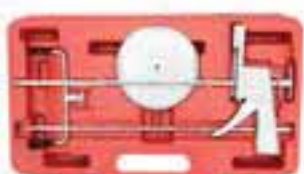

**Alignment Turn
Plate (Pair)**

SKU 751634 DAN135501 **429⁹⁹**

- Each Turn Plate is Equipped with Roller Bearings for 'Full-Floating' Movement to Assure Easy Front - Wheel Positioning for Accurate Caster and Steering
- Sold in Sets of 2
- Dimensions: 14" x 13.5" x 2"



**Steel Turn Plates
with Handle (Pair)**

SKU 463771 QSP25-140 **549⁹⁹**

- Capacity: 4,500 Lbs. per Plate
- Features Dynamic Load Control
- Dimensions: 14" x 14" x 1.5"



**Stainless Steel
Turn Plates
without Pointer (Pair)**

SKU 463808 QSP25-129 **949⁹⁹**

- Capacity: 4,500 Lbs. per Plate
- Dimensions: 14" x 14" x 1.5"
- Fits Most Standard Alignment Racks



AUTOMOTIVE LIFTS

A FULL LINE OF LIFTS AVAILABLE FROM



2 Post Lifts - 10K Lbs.



Brigadier D-10 ACX

SKU 186433
DAN1375647 **3,059⁹⁹**

Asymmetric

- Lifting Capacity: 10,000 Lbs. (4,546 Kg)
- Overall Height: 145" (3,683 mm)
- Overall Width (Outside of Base Plates): 143-1/2"
- Width Between Columns: 112-3/4"
- Rise: 69" (1,753 mm)
- Maximum Lifting Height (Pad and 6" Adapter): 79" (2,007 mm)
- Drive-Thru Clearance: 100-1/2"
- Motor: 220 VAC 60Hz. 1Ph



WARRANTY: 3 Year Parts, Labor and Structure

Truck Adapters Included
Price does not include vehicles, installation or optional equipment as shown

BEST VALUE

10,000 Lbs. 2 Post Lift

SKU 499657
FOR10 **3,109⁹⁹**

- Spot-Rite™ 3-Stage Arms for Symmetric and Asymmetric Lifting
- 76-1/4" Rise
- Minimum Ceiling Height 144"
- Drive-Thru Clearance: 99"
- Thread-up Truck Adapters and Stackable Height Extensions

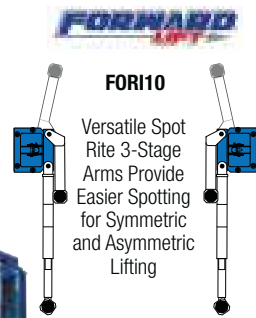

WARRANTY: 18 Months Parts and 6 Months Labor

Truck Adapters Included
Price does not include vehicles, installation or optional equipment as shown

10,000 Lbs. F10 2 Post Lift

SKU 818779
FORF10N100MBL **2,809⁹⁹**

- Low Profile/Oversized Pads to Raise Most Vehicles
- 3-Stage Front Arms for Symmetric and Asymmetric Lifting
- Includes (4) 3-1/2" and 5" Adapter Extenders



WARRANTY: 18 Months Parts, 6 Months Labor, 5 Years Structural

Stack Adapters Included
Price does not include installation or optional equipment as shown

10,000 Lbs. Dual Width Clearfloor 2 Post Lift, Screw Pad

- Expandable Top Beam Accommodates Wide or Narrow Drive-Thru Configuration
- Double Telescoping Screw Pads Offer Increased Versatility
- Overall Height: 145"

Asymmetric

SKU 297001 | BENXPR-10AS (shown)

3,439⁹⁹

- Inside Columns: 104" - 112"



Symmetric

SKU 296968 | BENXPR-10S

3,389⁹⁹

- Inside Columns: 105.5" - 118.5"

Stack Adapters Included
Price does not include vehicles, installation or optional equipment as shown

Asymmetric Low-Pro Arms

SKU 297003 | BENXPR-10ASLP (shown)

3,479⁹⁹

- Inside Columns: 104" - 112"



Symmetric Low-Pro Arms

SKU 296983 | BENXPR-10S-LP

3,419⁹⁹

- Inside Columns: 105-1/2" - 118-1/2"

Price does not include vehicles, installation or optional equipment as shown



Five Years (60 Months) Warranty
on the Lift Structure

10,000 Lbs. 2 Post Lift with 2-in-1 Lifting Arms



SKU 912314
AMM4TV21NSR1 **3,299⁹⁹**

- 90° Offset 3-Stage Front and Rear Arms for Asymmetric or Symmetric Vehicle Positioning
- Adjustable Height and Width Setting
- Includes Door Bumper Guards and Lift Adapters
- Premium US Made Power Unit
- ALI/ETL Certified
- 148" Height



Frame Cradle Stack Adapters Included Value: **\$695**

Price does not include vehicles, installation or optional equipment as shown

SA10 10,000 Lbs. 2 Post Vehicle Lift

SKU 847098
CHLSA10

3,409⁹⁹

- Can Be Configured in Either the Symmetric or Asymmetric Position
- 3-Stage Front Arms Provide Greater Overall Arm Sweep
- Double Telescoping Screw Pads



CHLSA10

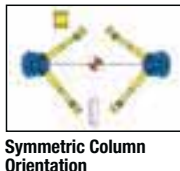

Symmetric Column Orientation

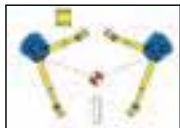

Asymmetric Column Orientation

E10 10,000 Lbs. 2 Post Lift

SKU 435061
CHLLE10 **3,199⁹⁹**

- 3-Stage Front Arms and 2-Stage Rear Arms for Asymmetric or Symmetric Lifting
- Double Telescoping Screw Pads with Rubber Foot Pads
- Rubber Door Guards Protect Vehicle from Door Damage
- 11' 11-7/8" Standard Height Fits in Service Bay with 12' Ceiling Height

Stack Adapters Included
Price does not include vehicles, installation or optional equipment as shown

10,000 Lbs. 2 Post Lift

SKU 298485
CHLCL10V3 **4,589⁹⁹**

Versymmetric 3-Stage Arms

Designed to Lift Anything from a Compact Car to a Full Size Truck

- Column Height: 11' 8"
- Adjustable Width Overall: 11' 6-1/2" / 11' 11"
- Floor to Overhead Switch: 134-1/2"
- Ceiling Height Required: 12'
- Drive-Thru Clearance: 100" / 104 -1/2"



Stack Adapters Included
Price does not include vehicles, installation or optional equipment as shown

10,000 Lbs. 2 Post Lifts

SKU 534581
ROTSPA10 **4,189⁹⁹** Asymmetric

- Made in Madison, IN with U.S. Steel
- True Asymmetric with Columns at Rotated 30°
- 3 Position Flip-Up Adapters
- Single Point Lock Release
- Rise: 78-1/4"



WARRANTY: 1 Year Parts and 1 Year Labor

SKU 210371 | ROTSP010

4,189⁹⁹ Symmetric

Price does not include vehicles, installation or optional equipment as shown

Quick Rise - 2 Post

CL10 Versymmetric® 10,000 Lbs. 2 Post Dual Pendant Controls QuickCycle™ Lift

SKU 851780
CHL10V3DPCQC **6,569⁹⁹**

- Featuring Dual Pendant Control System – Operate Lift from Either Column
- Versymmetric 3-Stage Front and 3-Stage Rear Arms
- Safely Lift Everything from Small Sedans to Trucks and SUVs
- Comes Standard with a Full Set of Adapters and Adjustable Foot Pads

Price does not include vehicles, installation or optional equipment as shown



Shockwave SPOA10SW 10,000 2 Post Lift

SKU 765481
ROTSPA10U705 **5,999⁹⁹**

2 Times Faster Rise and Descent

- 5 HP Motor
- 110V DC Power with Built-in Battery Charger
- Spotline Laser with Motion Sensor to Aid in Centering Vehicle
- Baseplate Covers Included

WARRANTY: 1 Year Parts and 1 Year Labor

Price does not include vehicles, installation or optional equipment as shown



• Free Delivery in 48 Continental United States • Specifications Subject to Change without Notice or Liability. Prices Do Not Include Vehicles, Installation or Optional Equipment as Shown. • Customers Responsible for Off-Loading Equipment Upon Arrival. Ask Your Sales Rep for Details. • Leasing Terms Available.† Ask Your AutoZone® Commercial Sales Manager.

2 Post Lifts – 12K Lbs.

12,000 Lbs. 2 Post Lift with 2-in-1 Lifting Arms

SKU 765526 AMM4T212NSR1 **4,589⁹⁹**

- 90° Offset 3-Stage Front and Rear Arms for Asymmetric or Symmetric Vehicle Positioning
- Adjustable Height and Width Setting
- Includes Door Bumper Guards and Lift Adapters
- Premium US Made Power Unit
- ALI/ETL Certified
- Overall Height: 154"



Frame Cradle Stack Adapters Included Value: **\$695**

Price does not include vehicles, installation or optional equipment as shown

12,000 Lbs. F12N300 2 Post Lift

SKU 818751 FORF12N300BL **4,649⁹⁹**

- 2-Stage Arms Reach: 35" to 54"
- Accommodates Trucks and Many Cars
- Low Profile 4-3/4" Adapters
- Includes Four 3-1/2" and 5" Adapter Extenders



WARRANTY: 18 Months Parts, 6 Months Labor & 5 Years Structure

Truck Adapters Included
Price does not include installation or optional equipment as shown

2-Stage Front and Rear Arms Height Configurations of 11'-10", 12'-10", and 14'-10" are Available

12,000 Lbs. I12N300 2 Post Lift

SKU 818755 FORI12N300BL **5,709⁹⁹**

- Four Robust 3-Stage Arms with Reach Range from 27-1/2" to 59"
- Low Profile 4.3/4" Adapter
- Includes 1.3/4", 3-1/2" and 5" Adapter Extenders
- Minimum Ceiling Height 167"
- ETL Certified to ANSI/ALI ALCTV: 2011



WARRANTY: 18 Months Parts and 6 Months Labor

Truck Adapters Included
Price does not include installation or optional equipment as shown

3-Stage Front and Rear Arms Height Configurations of 11'-10", 12'-10", and 14'-10" are Available

E12 12,000 Lbs. 2 Post Heavy Duty Lift

SKU 344994 CHLE12 **4,999⁹⁹**

- 2-Stage Telescoping Arms Provide Excellent Reach to Accommodate Vehicle Lifting Points
- 13' 10" or 14' 7" Adjustable Column Height
- Heavy Duty Telescoping Screw Pads



Truck Adapters Included
Price does not include vehicles, installation or optional equipment as shown

CL12, 12,000 Lbs. 2 Post Symmetric Lift

SKU 750127 CHLCL12 **7,199⁹⁹**

- Lifts Small Sedans to Heavy Duty Pickups
- 3-Stage Front and 3-Stage Rear Arms Provide Greater Extension and Retraction
- Rise Height: 84-3/4" (2153 mm)
- Ceiling Height Required: 13' 9"



Truck Adapters Included
Price does not include vehicles, installation or optional equipment as shown

12,000 Lbs. 2 Post Lift, Clearfloor, Triple-Telescope Arms

SKU 296957 BENXPR-12CL **5,219⁹⁹**

- Drop-End Arms Provide a Lower Pad Height
- Triple-Telescoping Front and Rear Arms
- Height Overall: 170"
- Inside Columns: 120"



Truck Adapters Included
Price does not include vehicles, installation or optional equipment as shown

WARRANTY: 1 Year Parts and 1 Year Labor

2 Post Lifts – 15K-18K Lbs.

E15 15,000 Lbs. Symmetric 2 Post Lift

SKU 814188 CHLE15 **7,759⁹⁹**

- Heavy Duty 2-Stage Telescoping Arms
- Adjustable Column Height
- Padded Overhead Shut Off System
- Rubber Door Guards
- Plated Arm Restraints and Arm Pins



Truck Adapters Included
Price does not include installation or optional equipment as shown

15,000 Lbs. 2 Post Lift, Clearfloor, Standard Arms

SKU 296916 BENXPR-15CL **8,859⁹⁹**

- Taller Column Height Provides Greater Overhead Clearance
- Versatile Drop-in Contact Pads with Stackable 8-Piece Truck and Van Adapters
- Frame Cradle Pads Come Standard
- 2-Stage Telescoping Front and Rear Arms
- Overall Height: 170"
- Inside Columns: 120"



WARRANTY: 1 Year Parts and 1 Year Labor

Truck Adapters Included
Price does not include vehicles, installation or optional equipment as shown

18,000 Lbs. 2 Post Lift, Clearfloor, Standard Arms

SKU 296884 BENXPR-18CL **9,719⁹⁹**

- Taller Column Height Provides Greater Overhead Clearance
- Versatile Drop-in Contact Pads with Stackable 8-Piece Truck and Van Adapters
- Frame Cradle Pads Come Standard
- 2-Stage Telescoping Front and Rear Arms
- Overall Height: 170"
- Inside Columns: 120"



WARRANTY: 1 Year Parts and 1 Year Labor

Truck Adapters Included
Price does not include vehicles, installation or optional equipment as shown

15002-3S 15,000 Lbs. 2 Post Lift with 3-Stage Arms

SKU OUTSIDE BUY/EPO CHL15000-3S **14,149⁹⁹**

- 3-Stage Front and 3-Stage Rear Arms
- Lower Profile Pad Adapters
- Single Point Air Actuated Lock Release
- Rise Height: 81-1/4"
- Column Height: 174"



Available via Outside Buy/EPO, Call 1-877-298-6651 for Ordering Instructions

Price does not include vehicles, installation or optional equipment as shown

2 Post Floorplate Lifts

D-8 8,000 Lbs. 2 Post Lift

SKU OUTSIDE BUY/EPO DAN1375700 **3,059⁹⁹**

- Perfect for Shops and Garages with Height Restrictions
- Overall Height: 113"



Truck Adapters Included
Price does not include vehicles, installation or optional equipment as shown

WARRANTY: 3 Year Parts, Labor and Structure

Available via Outside Buy/EPO, Call 1-877-298-6651 for Ordering Instructions

Dual-Width, 9,000 Lbs. 2 Post Lift, Floorplate, Short Lift

SKU 296813 BENXPR-9S **3,449⁹⁹**

- Shorter Columns for Low-Ceiling Installations
- Adjustable Width Design Configures for Wide or Narrow Installation
- Telescoping Low-Pro™ Arms Accommodate Lowered Sports Cars
- Large, 20" x 19" Steel Base Plates
- Overall Height: 113"
- Inside Columns: 105"-118"



Truck Adapters Included
Price does not include vehicles, installation or optional equipment as shown

WARRANTY: 1 Year Parts and 1 Year Labor

CLFP9 9,000 Lbs. Floorplate 2 Post Lift

SKU 851779 CHLCLFP9 **3,659⁹⁹**

- 3-Stage Front and Rear Arms Provide Excellent Reach to Lift a Variety of Vehicles
- Drive-Thru Clearance: 98-3/16"
- Minimum Ceiling Height: 121-7/8"
- Double Telescoping Screw Pads Adjust to Multiple Heights Minimizing the Need for Adapters



Price does not include installation or optional equipment as shown

12,000 Lbs. Floorplate, Direct-Drive 2 Post Lift

SKU 297199 BENXPR-12FDL **5,289⁹⁹**

- Open-Top Eliminates Overhead Obstruction
- Versatile Drop-in Contact Pads with Stackable 8-Piece Truck and Van Adapters
- Frame Cradle Pads Come Standard
- Triple-Telescoping, Low Profile Arms
- Overall Height: 144"
- Inside Columns: 118"



Truck Adapters Included
Price does not include vehicles, installation or optional equipment as shown

WARRANTY: 1 Year Parts and 1 Year Labor

• Free Delivery in 48 Continental United States • Specifications Subject to Change without Notice or Liability. Prices Do Not Include Vehicles, Installation or Optional Equipment as Shown. • Customers Responsible for Off-Loading Equipment Upon Arrival. Ask Your Sales Rep for Details. • Leasing Terms Available.† Ask Your AutoZone® Commercial Sales Manager.

AUTOMOTIVE LIFTS

AC HYDRAULIC ROLLING JACK WORKS WITH MOST LIFTS



SD26PHL 5,700 Lbs. Air-Hydraulic Jacking Beam

SKU 912323
ACHSD26PHL **1,999⁹⁹**

- Reliable and Quiet Pump for Quick and Efficient Lift
- Closed Height: 7.09"
- Flexible Top Support Beam Can Be Extended Up to 63.39"
- Unique Height Adjustable Support Arm System – Designed to Fit All Current Lifts and Pits
- Two-Hand Lowering Operation with Dead Man's Release
- Includes 3 Extension Sets and Rubber Cushion for Protection of Car Body
- Automatic Safety Locking Device and Overload Valve



Support Arms for SD26PHL Beam

SKU 912317
ACHSUPPARMS **199⁹⁹**

- Required with the purchase of ACHSD26PHL

10 YEAR
3 YEAR
UNLIMITED
WARRANTY

4 Post Lifts

Major D-12™ 12,000 Lbs. 4 Post Lift

SKU 343410
DAN1375681 **4,739⁹⁹**

- Single Hydraulic Cylinder Mounted Underneath Runway
- Internal "Anti-Sway" Slider Blocks in Each Column
- Oversized Self-Lubricating Cable Rollers
- Multi-Position Safety Locks in Each Column
- Push-Button Safety Release
- Runways Adjust for Different Tread Widths



WARRANTY: 3 Year Parts, Labor and Structure

Rolling Jacks Sold Separately

Price does not include vehicles, installation or optional equipment as shown



14,000 Lbs. 4 Post Lift

SKU 898152
BENHDS14 **5,149⁹⁹**

- Overall Width: 130"
- Overall Length: 241"
- Max. Rise: 70"
- Motor: 220 VAC/1 Ph



WARRANTY: 1 Year Parts & 1 Year Labor

Rolling Jacks Sold Separately

Price does not include vehicles, installation or optional equipment as shown



Shown with
Optional
Equipment

WORKS WITH

4 Post 6,000 Lbs. Rolling Bridge Jack DRJ-6

SKU 343411
DAN1375901 **1,209⁹⁹**

Optional
Equipment



WORKS WITH

7,000 Lbs. Capacity Rolling Bridge Jack

SKU 949548
BENRB7000 **1,639⁹⁹**

Optional
Equipment



14,000 Lbs. 4 Post Lift

SKU 696483
FORCR14N100 **4,669⁹⁹**

- Heavy Duty Hydraulic Cylinder
- Single Point Latch Release System
- 78-3/4" Rise
- 18 Lock Positions
- Accommodates 182-1/2" Wheelbase Vehicles
- High Performance Cable and Sheave System
- ETL Certified



WARRANTY: 18 Months Parts and 6 Months Labor

Rolling Jacks Sold Separately
Price does not include installation or optional equipment as shown



Challenger 4P14 14,000 Lbs. 4 Post Lift

SKU 851781
CHL4P14EFX **5,429⁹⁹**

- Louvered Approach Ramps for Positive Vehicle Traction
- Adjustable Runways to Accommodate a Variety of Tread Widths
- Column Height: 90-1/2"
- Minimum Bay Size: 12' x 24'



Rolling Jacks Sold Separately
Price does not include installation or optional equipment as shown



18,000 Lbs. 4 Post General Service Lift

SKU 568426
FORCR18 **8,599⁹⁹**

- Max. Wheelbase: 194"
- Durable Cable and Sheave System
- ETL Certified to ANSI/ALI ALCTV: 2011



WARRANTY: 18 Months Parts and 6 Months Labor

18,000 Lbs. Long Wheelbase 4 Post Lift

SKU 568427
FORCR18LW **9,449⁹⁹**

- Max. Wheelbase: 230"

Rolling Jacks Sold Separately
Price does not include vehicles, installation or optional equipment as shown



WORKS WITH

7,000 Lbs. Rolling Jack

SKU 568445
FORRRJ70G **2,229⁹⁹**

Optional
Equipment



WORKS WITH

7,500 Lbs. Rolling Jack

SKU 264847
CHLRJ75 **2,389⁹⁹**

Optional
Equipment



WORKS WITH

9,000 Lbs. Rolling Jack

SKU 568446
FORRJ901000 **3,279⁹⁹**

Optional
Equipment



SAVE \$1,114⁹⁹

With Purchase of a Forward 4-Post Lift

Two 7,000 Lbs. Rolling Jacks

SKU 434708
FORRRJ70GB0G0 **3,344⁹⁹**

- Great Savings - Buy 1st FORRRJ70G at Regular Price, Get the Second One 1/2 Price
- Includes (2) Air/Hydraulic Rolling Jacks with (4) 3" Stack Adapters



SAVE \$1,194⁹⁹

When Purchased with a 4P14 Challenger Lift

Two 7,500 Lbs. Rolling Jacks

SKU 851169
CHLRJ75B0G0 **3,584⁹⁹**

- Great Savings - Buy 1st CHLRJ75 at Regular Price, Get the Second One 1/2 Price
- Includes (2) Air/Hydraulic Rolling Jacks with (4) 3" Stack Adapters



SAVE \$1,639⁹⁹

With Purchase of a Forward 4-Post Lift

Two 9,000 Lbs. Rolling Jacks

SKU 435068
FORRJ9010B0G0 **4,919⁹⁹**

- Great Savings - Buy 1st FORRJ901000 at Regular Price, Get the Second One 1/2 Price
- Includes (2) Air/Hydraulic Rolling Jacks with (4) 3" Stack Adapters



Storage Lifts

Commander D-7

SKU 186464
DAN1375643 **3,119⁹⁹**

- Spring-Loaded Safety Locks on Each Column
- Self-Lubricating UHMW Polyethylene Internal Slide Blocks
- Single Safety Lock Release Handle
- 7,000 Lbs. Capacity Free Standing Design
- Detachable Drive-Up Ramps Included



WARRANTY: 3 Year Parts, Labor and Structure

Rolling Jacks Sold Separately

Price does not include vehicles, installation or optional equipment as shown



8,000 Lbs. EFP8 Home Storage 4 Post Lift

SKU 818781
FOREFP8P000M **2,889⁹⁹**

- Perfect for Home Use
- Includes: Steel Approach Ramps, Jack Tray, Wheel Caster Kit and Drip Trays
- Wired to Plug into 115V Receptacle



Rolling Jacks Sold Separately

Price does not include vehicles, installation or optional equipment as shown

WARRANTY: 18 Months Parts and 6 Months Labor



9,000 Lbs. 4 Post Lift

SKU 898142
BENHD-9 **3,369⁹⁹**

- Overall Width: 116-3/4" (2,965 mm)
- Overall Length: 200" (5,080 mm)
- Column Height: 88" (2,235 mm)
- Max. Lifting Height: 74-1/2" (1,892 mm)



WARRANTY: 1 Year Parts and 1 Year Labor

Rolling Jacks Sold Separately

Price does not include vehicles, installation or optional equipment as shown



WORKS WITH

Jack Platform

SKU 186438
DAN119442 **159⁹⁹**

Optional
Equipment



WORKS WITH

3,500 Lbs. RJ35BK Hand Pump Rolling Jack

SKU 818764
FORRJ35BK **829⁹⁹**

Optional
Equipment



WORKS WITH

4,500 Lbs. Capacity Rolling Bridge Jack

SKU 949556
BENRBJ4500 **1,439⁹⁹**

Optional
Equipment



- Free Delivery in 48 Continental United States
- Specifications Subject to Change without Notice or Liability. Prices Do Not Include Vehicles, Installation or Optional Equipment as Shown.
- Customers Responsible for Off-Loading Equipment Upon Arrival. Ask Your Sales Rep for Details.
- Leasing Terms Available.† Ask Your AutoZone® Commercial Sales Manager.

QuickJack™ Lifts

You get it all.

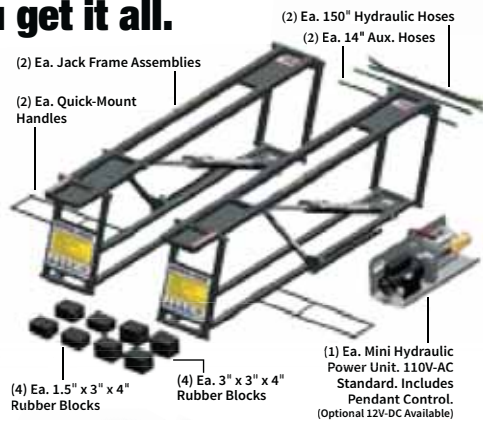

- Complete Package Includes:
 - (2) Jack Frame Assemblies,
 - (2) 150" Hydraulic Hoses,
 - (2) 14" Aux. Hoses,
 - (2) Quick-Mount Handles,
 - (4) 1.5" X 3" X 4" Rubber Lifting Blocks,
 - (4) 3" X 3" X 4" Rubber Lifting Blocks,
 - (1) Mini Hydraulic Power Unit with Pendant Control



12V DC Option Available

QUICKJACK™



SPECIFICATIONS	RANBL3500SLXA SKU 850894	RANBL5000SLXA SKU 850896	RANBL5000EXTA SKU 752058	RANBL7000SLXA SKU 850897	RANBL7000EXTA SKU 752061
Weight Capacity / Pair	3,500 Lbs. / 1588 kg.	5,000 Lbs. / 2268 kg.	5,000 Lbs. / 2268 kg.	7,000 Lbs. / 3175 kg.	7,000 Lbs. / 3175 kg.
Individual Frame Weight:	60 Lbs. / 27 kg.	76 Lbs. / 34 kg.	80 Lbs. / 36 kg.	91 Lbs. / 41 kg.	101 Lbs. / 46 kg.
Platform Lifting Height (Frame Only)	16.5" / 419 mm.	17.2" / 437 mm.	17.6" / 447 mm.	17.7" / 450 mm.	18.2" / 462 mm.
Platform Lifting Height (W/Blocks)	20" / 508 mm.	22.5" / 572 mm.	21.3" / 542 mm.	21.2" / 538 mm.	21.6" / 546 mm.
Minimum Collapsed Height	3" / 76 mm.	3" / 76 mm.	3" / 76 mm.	3.5" / 89 mm.	3.6" / 91 mm.
Rubber Block Position Min	26.7" / 678 mm.	31.5" / 800 mm.	37.4" / 951 mm.	31.5" / 800 mm.	37.4" / 951 mm.
Rubber Block Position Max	50.5" / 1283 mm.	60" / 1524 mm.	66" / 1676 mm.	60" / 1524 mm.	66" / 1,676 mm.
Frame Width	10.5" / 267 mm.	11" / 278 mm.	11" / 278 mm.	12.5" / 318 mm.	12.5" / 318 mm.
Frame Length	62" / 1575 mm.	72.5" / 1841 mm.	75" / 1905 mm.	72.5" / 1841 mm.	76" / 1,930 mm.
Lifting Time	10 seconds	15-30 seconds	15-30 seconds	15-30 seconds	15-30 seconds
Input Power	110V AC	110V AC	110V AC	110V AC	110V AC
	1,159⁹⁹	1,369⁹⁹	1,429⁹⁹	1,529⁹⁹	1,579⁹⁹

QuickJack™ SUV and Light Truck Adapters

SKU 862288
RAN5150561 **229⁹⁹**

- Set of 12 Pieces
- Fits BL-5000 and BL-7000 Series
- Complete Kit Includes: (4) Low Profile Round Polyurethane Contact Pads (4) Sliding Receivers Accommodate the Round Polyurethane Contact Pads (4) 3" Stackable Adapters



Price does not include vehicles, installation or optional equipment as shown

Mid-Rise Lifts

Cadet-6000XL

SKU 555446
DAN1375652 **2,279⁹⁹**

- For Servicing Light-Duty Cars and Trucks
- Portable Motor Cart Serves as Tow Handle
- Adjustable Arm Assemblies
- Safety Bar with Multiple Lock Positions



Lift Gate Service

SKU 262534
DANLIFTGATE **100⁰⁰**



Price does not include vehicles, installation or optional equipment as shown



6,000 Lbs. Mid-Rise Lift

SKU 499655
FOR6000MRL **2,029⁹⁹**

- Width: 41"
- Rise: 52"
- Length: 83"
- Multiple Locking Positions
- Truck Adapters Included

Lift Gate Service

SKU 626137
FORLIFTGATE **95⁰⁰**



WARRANTY: 18 Months Parts and 6 Months Labor

Price does not include vehicles, installation or optional equipment as shown



Portable 2 Post

M6 Portable 2 Post Lift

SKU OUTSIDE BUY/EPO
DAN1375685 **2,549⁹⁹**

- ALI Certified
- Patented Portable Design
- 7 Automatic Safety Locks
- Mobile Power Unit and Column Wheels for Portability
- Automatic Arm Restraints with Fully Adjustable Arms
- Industrial Grade Hydraulic Cylinders
- Durable Powder Coat Finish
- Motor: 110-220 VAC / 50-60 Hz. 1Ph



- 6,000 Lb. Lifting Capacity
- Minimum Pad Height: 3.5"

WARRANTY: 3 Year Parts, Labor and Structure

Available via Outside Buy/EPO, Call 1-877-298-6651 for Ordering Instructions
Price does not include vehicles, installation or optional equipment as shown

6,000 Lbs. Portable Mid-Rise Lift

SKU 210386
BENMD-6XP **2,279⁹⁹**

- Portable, Easy to Move from Bay-to-Bay
- Adjustable Arms

Lift Gate Service

SKU 262533
RANLIFTGATE **95⁰⁰**



Truck Adapters Included
Price does not include vehicles, installation or optional equipment as shown

Power Unit Plugs into 110v Outlet



6,000 Lbs. Portable Mid Rise Lift

SKU 264835
CHLQMR6 **2,239⁹⁹**

- Rise Height: 53-1/4"
- Includes Both 3" and 6-7/8" Adapters

Lift Gate Service

SKU 295540
OEMLIFTGATE **80⁰⁰**



Price does not include vehicles, installation or optional equipment as shown



Double Scissor

10,000 Lbs. Dual Scissor Lift

SKU OUTSIDE BUY/EPO
AMM4TS10SSOR1 **10,399⁹⁹**

- Min. Height: 8.3", Max. Height: 79.5"
- Compact Footprint: 81.9" (W) x 160" (L)
- Minimum Ceiling Height: 10'
- Ideal for Compact Cars and Light Duty Trucks
- Low Profile Ramps



Available via Outside Buy/EPO, Call 1-877-298-6651 for Ordering Instructions
Price does not include vehicles, installation or optional equipment as shown



Low-Rise Lifts

6,000 Lbs. Low-Rise Pad Lift

SKU 210383
BENLR-60 **1,949⁹⁹**

- Max. Height: 26"
- Overall Width: 70"
- Overall Length: 82"

Lift Gate Service

SKU 262533
RANLIFTGATE **95⁰⁰**

Price does not include vehicles, installation or optional equipment as shown

Portable

SKU 210384
BENLR-60P **1,979⁹⁹**

- Max. Height: 26"
- Overall Width: 70-1/2"
- Overall Length: 82"



7,000 Lbs. Low-Rise Pad Lift

SKU 568436
FORTL07 **2,459⁹⁹**

- Wired to Plug into 115V Receptacle
- Max. Rise: 21-3/4"

Lift Gate Service

SKU 626137
FORLIFTGATE **95⁰⁰**

WARRANTY: 18 Months Parts and 6 Months Labor
Price does not include installation or optional equipment as shown



10,000 Lbs. Low-Rise Pad Lift

SKU 479989
BENLR-5T **3,224⁹⁹**

- Max. Height: 23" - 32"
- Lowered Height: 4"
- Lift Blocks Included

Lift Gate Service

SKU 262533
RANLIFTGATE **95⁰⁰**

Price does not include installation or optional equipment as shown



Motorcycle Lifts

Motorcycle Jack

SKU 568452
FORBJ10 **194⁹⁹**

- Use with Forward FOR100MCL



1,000 Lbs. Air Operated Motorcycle Lift

SKU 499659
FOR100MCL **1,019⁹⁹**

- Includes Wheel Vise and Two 12" Extensions, Making it Great for Motorcycles, ATVs, Lawn Mowers, Golf Carts, etc.
- Rise 33", Length 93", Width 24", Width with ATV Adapters 48"

Lift Gate Service

SKU 626137
FORLIFTGATE **95⁰⁰**

WARRANTY: 18 Months Parts and 6 Months Labor
Price does not include vehicles, installation or optional equipment as shown



1,000 Lbs. Droptail Motorcycle Lift

SKU 568439
FOR100MCLDT **1,179⁹⁹**

- FORBJ10 Included
- Rise 33", Length 93", Width 24"

Lift Gate Service

SKU 626137
FORLIFTGATE **95⁰⁰**

WARRANTY: 18 Months Parts and 6 Months Labor
Price does not include vehicles, installation or optional equipment as shown



Motorcycle Lift

SKU 626120
RANRML-1500XL **1,449⁹⁹**

- Lifting Capacity: 1,500 Lbs. (682 kg)
- Power Supply: Air/Hydraulic
- Main Platform Length: 89" (2,286 mm)
- Main Platform Length with Front Extension: 102" (2,591 mm)
- Main Platform Width: 30" (762 mm)

Lift Gate Service

SKU 262533
RANLIFTGATE **95⁰⁰**

Price does not include vehicles, installation or optional equipment as shown



LIFT ACCESSORIES

Lift Accessories



Air/Electric Workstation for 2 and 4 Post Lifts

SKU 751635
DAN1980999 **239⁹⁹**

- Add 20 amp Outlets, Air Functionality and Tool/Line Holders By Attaching This Workstation to Your 2 and 4 Post Lift



Air/Electric Workstation

SKU 898684
BENWSA-100 **349⁹⁹**

- Adds Air and Electric Capabilities to Any BendPak Lift Simple
- Safe and Extremely Easy-to-Use
- (4) 110V GFI Outlets, Oiler, Air Supply, Pressure Gauge, Storage Hooks for Hose and Tools, Regulator/Filter, Air Inlet
- Fits 2 or 4 Post Lifts



You Will Need to Know BendPak Lift Model # When Ordering



Air/Electric Workstation for 4 Post Lifts

SKU 263294
CHL10310 **439⁹⁹**

- Convenient Power Source for Extension Lights and Other Tools
- Air Supply Will Always Be at Arms Reach for Facilities Using Pneumatic Tools Such as Impact Wrenches



Air/Electric Workstation

SKU 568448
FOR991359 **524⁹⁹**

- Use with Forward FOR10
- Air/Electric Workstation with Air Regulator and Oiler

Does not include hose and air gun

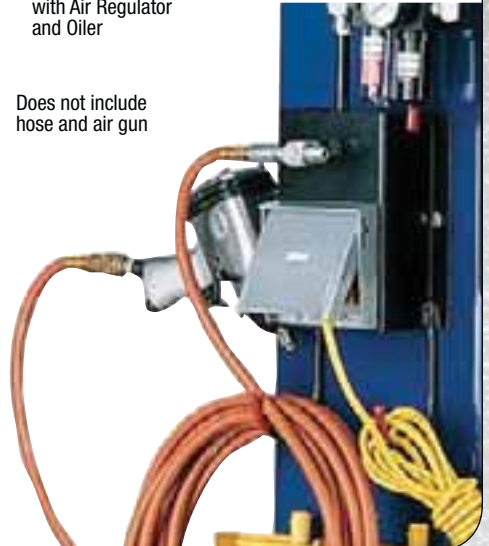

2 Post Lift Accessories



Rubber 2 Post Lift Pad/Slip Over/Round - 1 Each

SKU 343396
BEN5715017 **24⁹⁹**

- Slip Over Rubber Lift Pad for Use with BendPak 2 Post Lifts with Round Flat Contact Pads (Sold Individually)



Square Rubber Arm Pads - 1 Each

SKU 898880
BEN5715365 **24⁹⁹**

- Works with Any BendPak 2 Post Lift
- 5-5/8" Square
- 1-1/16" Thick

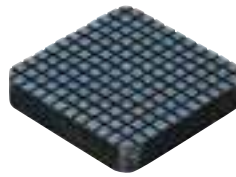

Frame Cradle Pad - 1 Each

SKU 466304
BEN5215506 **54⁹⁹**

- Works with Any BendPak 2 Post Lift
- Tactile Rubber Mat Reduces Slippage and Protects Finish



Round Rubber Lift Pad Assembly Drop-In - 1 Each

SKU 343397
BEN5215507 **54⁹⁹**

- Works with Any BendPak 2 Post Lift
- 1 Lift Pad, Sold Individually
- 5" Diameter for Enhanced Stability
- Easy Drop-in Design



Dannmar Frame Cradle Pad - 1 Each

SKU 289999
DAN119527 **54⁹⁹**

- Works with Any BendPak 2 Post Lift



I10 2 Post Carriage Door Bumper Kit

SKU 568451
FORTPB10-D1 **64⁹⁹**

- Use with Forward FOR10



Rubber Round Slip On Lift Pad

SKU OUTSIDE BUY/EPO
CHLB2208 **24⁹⁹**

- OE Challenger Lift Pads Found on Many Challenger Lifts



Available via Outside Buy/EPO,
Call 1-877-298-6651 for Ordering Instructions

I10 2 Post Lift Adjustable Adapters - Set of 4

SKU 568450
FORT100285 **399⁹⁹**

- Use with Forward FOR10
- Included Rubber Pad Eliminates Metal to Metal Contact
- Adapters Designed to Cradle Frames



Don't Let the Tire Make You Tired!

Omega Wheel Arm™

SKU OUTSIDE BUY/EPO
OMG92100 **89⁹⁹**

- Holds the Tire at Lift Arm Height and is Handy with Tire Rotations and Brake Jobs
- Easy and Safe for Mechanics to Put On or Take Off Tires
- Avoid Bending Over to Put Down or Pick Up a Tire
- Fits Most Lift Arms 3" - 5" Wide
- Set Includes (2) Wheel Arms and (2) Magnetic Tool Trays



Includes:
2 Round Magnetic Trays

Price does not include tires or rims as shown

While Supplies Last

Available via Outside Buy/EPO,
Call 1-877-298-6651 for Ordering Instructions



4 Post Lift Accessories

2 Drip Trays

SKU 301768
BEN5700301 **74⁹⁹**



Caster Wheel Set

SKU 898905
BEN5210997 **319⁹⁹**

- For Use on HD-9 Series Lift Only



Rolling Oil Drain

SKU 898714
BENDP-30 **399⁹⁹**

- Adjustable Width: 33" - 60"
- 15 Gallon Capacity



HIGHEST QUALITY ROLLING BRIDGE JACKS FOR YOUR DRIVE ON LIFT

Designed to Fit Any Lift or Pit Application

SPNJ7000L | OUTSIDE BUY/EPO

2,599⁹⁹

7,000 Lb. Cap.
Air Bag Design
Multi-level Lock
In-line Wheel Roller Assembly

Turn Your 4 Post Lift into a Productivity Center by Adding Rolling Jacks. Do Tires, Brakes, and Front End All with a Rolling Jack!



Available via Outside Buy/EPO,
Call 1-877-298-6651 for Ordering Instructions
Price does not include vehicles, installation or optional equipment as shown

STANDESIGN

DID YOU KNOW?

AutoZone® has over 3000 different part numbers available for replacement mirrors, headlight and taillight assemblies.

Contact Your AutoZone Commercial Sales Manager for Details



FREE OVERNIGHT SHIPPING
WITH MOST ORDERS
SEE PAGE 3 FOR DETAILS



Contact us at
877-866-5739

Prices Are Good January 1 Thru March 31, 2019
Promo Good While Supplies Last!
Available thru Outside Buy/EPO

NEW ATLAS PLATINUM LINE!

ATLAS PLATINUM



Atlas Platinum 2D Wheel Balancer

2,895⁹⁹

ATEAP-PWB50-FPD

- Rim sizes: 10"-30"
- 220 Volt power supply
- Self diagnosis and calibration
- 2 year parts warranty

Price does NOT include Wheels, Installation or Optional Equipment as shown

WARNING: Cancer and Reproductive Harm - www.P65Warnings.ca.gov

NEW



Atlas Platinum Tire Changer with Left-Hand Assist

3,745⁹⁹

ATEAP-PTC300-FPD

- Clamping range: 10"-26"
- 110 Volt motor and High-Torque Gearbox
- Integrated Beadblaster
- Handles up to a 30" wheel
- 2 year parts warranty

Price does NOT include Installation or Optional Equipment as shown

WARNING: Cancer and Reproductive Harm - www.P65Warnings.ca.gov

NEW



Atlas Platinum Center Post Tire Changer

6,845⁹⁹

ATEAP-PTC500-FPD

- Includes Patented 'Lever No Lever System' and 'Smart Lock' quick lock system
- Integrated Hand-Held Beadblast and Pedal operated Wheel Lift
- Clamping Range: 12" to 30"
- 2 year parts warranty

Price does NOT include Installation or Optional Equipment as shown

WARNING: Cancer and Reproductive Harm - www.P65Warnings.ca.gov



12,000 lb. Capacity Overhead 2-Post Lift, ETL/ALI

3,695⁹⁹

ATEATTD-APEX12-FPD

- Overall height: 165" (13' 9") or 177" (14' 9")
- Symmetric arms • ETL/ALI Certified

WARNING: Cancer and Reproductive Harm - www.P65Warnings.ca.gov



Price does NOT include Installation or Optional Equipment as shown



9,000 lb. Capacity Baseplate 2-Post Lift, ETL/ALI

2,595⁹⁹

ATEATTD-APEX9BP-FPD

- Overall height: 111-1/8" (9' 3-1/8")
- Symmetric arms
- ETL/ALI Certified

Price does NOT include Vehicles, Installation or Optional Equipment as shown

WARNING: Cancer and Reproductive Harm - www.P65Warnings.ca.gov



8-Camera Bluetooth Wireless Alignment Machine with 3 Point Clamps

13,945⁹⁹

ATEATEDGE-5013P-FPD

- Precision CCD measuring
- Bluetooth® wireless sensors
- 8-camera optical system
- Includes 10"-24" non-runout 3-pt FastClamp wheel clamps
- Cart style cabinet with printer, 19" LCD display and keyboard

WARNING: Cancer and Reproductive Harm - www.P65Warnings.ca.gov



Price does NOT include Installation or Optional Equipment as shown



10,000 LB. Capacity Extra Tall Overhead 2-Post Lift, ETL/ALI

2,745⁹⁹

ATEATTD-APEX10-FPD

- Overall height: 139-7/8" (11' 7 7/8") or 135 7/8" (11' 3 7/8")
- Super-symmetric arms
- 2 yr warranty on material and workmanship

WARNING: Cancer and Reproductive Harm - www.P65Warnings.ca.gov

Price does NOT include Installation or Optional Equipment as shown

9,000 lb. Capacity Overhead 2-Post Lift

2,145⁹⁹

ATEATPK-90HSCSS-FPD

- Overall height: 142" (11' 10")
- Super-symmetric arms
- 2 year warranty on material and workmanship

WARNING: Cancer and Reproductive Harm - www.P65Warnings.ca.gov



Price does NOT include Installation or Optional Equipment as shown

Tire Changer with Left Hand Assist Arm

2,845⁹⁹

ATETC289LH-FPD

- Clamping range: 11-7/8" - 28"
- Beadblaster included
- 110 Volt motor
- 1 year warranty on material and workmanship

Price does NOT include Installation or Optional Equipment as shown

WARNING: Cancer and Reproductive Harm - www.P65Warnings.ca.gov



Bluetooth® Wireless Alignment Machine with 3 Point Clamps

16,595⁹⁹

ATEATEDGE-601-P-FPD

- No rollback compensation required
- Measure virtually anywhere with Bluetooth® wireless sensors
- Precision 8-camera CCD optical system
- Wireless mobile app compatible
- Includes 10"-24" non-runout 3-pt FastClamp wheel clamps
- Deluxe cart style cabinet with printer, 19" LCD display and keyboard

WARNING: Cancer and Reproductive Harm - www.P65Warnings.ca.gov



Price does NOT include Installation or Optional Equipment as shown

14,000 lb. Capacity 4-Post Lift

4,795⁹⁹

ATEATTD-APEX14-FPD

- Overall height: 7' 8-1/2"
- Overall floor width (w/o motor): 10' 11-2/3"
- Clearance between columns: 9' 8-1/2"
- Maximum lift height: 6' 4-1/2"
- ETL/ALI Certified • Freight pre-paid

WARNING: Cancer and Reproductive Harm - www.P65Warnings.ca.gov



Price does NOT include Installation or Optional Equipment as shown



Computer Wheel Balancer

1,545⁹⁹

ATEATWB11-FPD

- Rim sizes: 10"-32"
- Maximum wheel weight: 150 lb.
- 110 V/1-phase
- Display in standard or metric units
- Self-diagnosis / Self-calibration

WARNING: Cancer and Reproductive Harm - www.P65Warnings.ca.gov

Price does NOT include Wheels, Installation or Optional Equipment as shown

Prices Subject to Change without Notice. Please Do Not Return Purchases to the Store. For Information Regarding Warranty or Repair and/or Any Questions or Concerns, Please Call 1-877-AZT00L1.

DID YOU KNOW?

AutoZone® carries vehicle make-specific body fastener kits.

Contact Your AutoZone Commercial Sales Manager for Details

TUXEDO DISTRIBUTORS LLC

Automotive Equipment & Accessories

Tuxedo Distributors LLC is a leading importer of high quality automotive repair equipment offering a full line of automotive equipment at an economical price. With our 10 satellite warehouses strategically located across the US, we offer an unparalleled competitive advantage.

Call to place order!

817.558.9337

877.558.9337 Toll Free

WHEEL SERVICE

TC-530 1,469⁹⁹

- Semi-Automatic Tire Changer
SKU 426751
- Internal Clamping Capacity: 12" - 23"
 - External Clamping Capacity: 10" - 20"
 - Max Wheel Diameter: 38"
 - Wheel Width: 3" - 12"
 - Swing arm design
 - Bead seating inflation jets are integrated in the clamping jaws
 - Side mounted Bead Breaker



Price Does Not Include Installation or Optional Equipment as Shown



TC-950 1,679⁹⁹

- Semi-Automatic Tire Changer
SKU 426755
- Max Wheel Diameter: 47"
 - Rim Width: 3" - 15"
 - Rim Diameter: 15" - 28"
 - Working Pressure: 8-10 bar
 - Swing arm design
 - No scratching. Machine contacts rim eliminating accidental damage
 - Conveniently located and powerful bead breaker



Price Does Not Include Installation or Optional Equipment as Shown



TC-950WPA 2,719⁹⁹

- High Performance Tire Changer with Press Arm
SKU 592177
- Internal Clamping Capacity: 15" - 28"
 - External Clamping Capacity: 13" - 24"
 - Max Wheel Diameter: 47"
 - Wheel Width: 3" - 15"
 - Swing arm design
 - Bead seating inflation jets are integrated in the clamping jaws
 - Twin clamping cylinders provide more power to hold the most difficult rims
 - Conveniently located and powerful bead breaker
 - Large diameter hex mount/demount shaft for extra rigidity
 - Left side press arm (WPA)
 - Ideal for low profile tires (WPA)
 - No scratching, machine never contacts rim (WPA)



NEW COMBO PRICING!

TC-950 2,629⁹⁹

- Semi-Automatic Tire Changer
- Max Wheel Diameter: 47"
 - Rim Width: 3" - 15"
 - Rim Diameter: 15" - 28"

Price Does Not Include Installation or Optional Equipment as Shown



WB-953

- High Performance Wheel Balancer
- Max Wheel Diameter: 39"
 - Rim Width: 1.5" - 20"
 - Rim Diameter: 10" - 24"
 - Wheel Weight Capacity: 150 lbs

SKU 426755	TC-950 Tire Changer	\$1,679.99
SKU 426803	WB-953 Wheel Balancer	\$1,159.99
	Regular Price	\$2,839.98
SKU 880175	COMBO PRICE	\$2,629.99
	SAVINGS	\$209.99

WB-953-B

- High Performance Wheel Balancer
SKU 592171
- Max Wheel Diameter: 39"
 - Rim Width: 1.5" - 20"
 - Rim Diameter: 10" - 24"
 - Wheel Weight Capacity: 150 lbs
 - Self-calibrating; Self-diagnosis
 - Optimization program
 - Static balancing
 - Three centering cones
 - Hammer, speed nut and caliper come standard
 - Optional motorcycle adapter is available

1,079⁹⁹



Price Does Not Include Installation or Optional Equipment as Shown



WB-953

- High Performance Wheel Balancer
SKU 426803
- Max Wheel Diameter: 39"
 - Rim Width: 1.5" - 20"
 - Rim Diameter: 10" - 24"
 - Wheel Weight Capacity: 150 lbs
 - Self-calibrating; Self-diagnosis
 - Optimization program

1,159⁹⁹



- Static balancing
- Three centering cones
- Hood, hammer, speed nut and caliper come standard
- Optional motorcycle adapter is available

Price Does Not Include Installation or Optional Equipment as Shown



IWA-60-1500-K 10,599⁹⁹

- Image Wheel Aligner
SKU 592176
- High Resolutions Cameras
 - Mobile Multi-Bay Capable
 - Non-proprietary Windows PC
 - Wireless Internet Connection
 - German Engineered Alignment Software
 - Advanced Alignment Measurements with Reading/Specifications and Cross Values
 - Comprehensive Database 25+ Spec Years

- Illustration Diagrams
- Integrated Help System
- Non-proprietary Windows PC lifts
- Expert USA technical support
- UPS with AVR Included

Price Does Not Include Installation or Optional Equipment as Shown



Additional Charges for lift gate delivery may apply

WB-CB66-VE 1,319⁹⁹

- High Performance Large Wheel Balancer
SKU 592163
- Keypad Data Entry
 - Max Wheel Diameter: 44"
 - Rim Width: 1.5" - 20"
 - Rim Diameter: 8" - 28"
 - Wheel Weight Cap: 150lbs
 - Accuracy: 1 gram
 - Three centering cones
 - Hood, hammer, speed nut and caliper come standard
 - Multi-Mode Balancing for SUV, Car & Motorcycle
 - Laser and Light indicators for unbalanced wheel weight positions
 - Foot Brake for accurate weight applications

Price Does Not Include Installation or Optional Equipment as Shown



FRAME MACHINES

FR-77-18 14,599⁹⁹

- Steel Plate / 18'
SKU 426651

FR-77-20 15,899⁹⁹

- Steel Plate / 20'
SKU 592195

FR-77T-18 11,899⁹⁹

- Tubular / 18'
SKU 592192

FR-77T-20 12,599⁹⁹

- Tubular / 20'
SKU 592193



Price Does Not Include Installation or Optional Equipment as Shown

- Lifting Capacity: 7,700 lbs.
- Deck Length: 18' / 20'
- Deck Width: 82.6"
- Deck Height: 19.7"
- Pull Force Per Tower: 10 Ton
- Required Air Power: 100 - 120 PSI
- Designed to accommodate Full-frame or Uni-body type vehicle
- Hydraulic Tilt Deck operation
- Universal Anchoring System
- Clear Floor, 360 degree Pulling Capability
- Twin 10 Ton round Pull Towers w/telescoping Tower-Heads

*20 and 25 Piece Tool Board Kit Sold Separately



DURO HYDRAULICS



459⁹⁹

- PU-110V-S-K
SKU 426832
•110VAC-1.5GAL
•2.5HP

459⁹⁹

- PU-220V-L-H
SKU 426847
•220VAC-3.5GAL
•2.5HP

SPXFLOW



459⁹⁹

- PU-110V-L-K
SKU 426833
•110VAC-3.5GAL
•2.5HP

459⁹⁹

- PU-220V-L-H-X
SKU 094226
•220VAC-3.5GAL
•2.5HP

500⁹⁹

- PU-110V-S-S
SKU 426834
•115VAC-1.5GAL
•1HP

550⁹⁹

- PU-S-AB-1270
SKU 426850
•230VAC-3.5GAL
•2HP

500⁹⁹

- PU-110V-L-S
SKU 426839
•115VAC-3.5GAL
•1HP

530⁹⁹

- PU-S-AC-10AH
SKU 426568
•230VAC-3.5GAL
•2HP

PAINT BOOTHS

PSB-AFCF23B-3PH-230V-AK 10,399⁹⁹

- CROSS FLOW DRAFT PAINT SPRAY BOOTH
SKU 799158
- Inside Dimension: 22'L x 13'W x 8'6"H
 - Outside Dimension: 25'-4"L x 13'-4"W x 8'- 10"H
 - Fan / Motor: 24" Tube Axial Fan 3HP-3PH-230/460VAC-60HZ Non-Spark, NEMA RATED

- High Quality UL Listed lighting fixtures. (Bulbs Included)
- Tilt Panel Design for optimal lighting coverage
- 5/16" Nut & Bolt Installation
- High Quality Intake and Exhaust Filters
- Heavy Duty 18 Gauge Panel Construction
- Personnel Door with Viewing Window
- Powder Coated Finish (Inside and Out)
- UL Control Panel, limit switches and solenoid valve included
- All hardware included
- Detailed Instructions



Price Does Not Include Installation or Optional Equipment as Shown



PSB-SDD26B-3PH-230V-AK 16,099⁹⁹

- SIDE DOWNDRAFT PAINT SPRAY BOOTH
SKU 592190
- Inside Dimension: 26'L x 14'W x 9'3"H
 - Outside Dimension: 28'-4"L x 17'-8"W x 9' - 5"H (2x) 24" Tube Axial Fans 2HP-3PH-230/460VAC-60HZ Non-Spark, NEMA RATED

- High Quality UL Listed lighting fixtures. (Bulbs Included)
- Hip Roof Design for Optimal Lighting
- 5/16" Nut & Bolt Installation
- (2x8") Exhaust Chimney Stack Assemblies Included
- High Quality Intake and Exhaust Filters
- Heavy Duty 18 Gauge Panel Construction
- Tri-fold and Personnel Doors with Viewing Windows.
- Powder Coated Finish (Inside and Out)
- UL Control Panel, limit switches and solenoid valve included
- All hardware included
- Detailed Instructions
- Optional Plenum Kit Sold Separately

Price Does Not Include Installation or Optional Equipment as Shown



*Optional Plenum Kit Shown



FREE OVERNIGHT SHIPPING
WITH MOST ORDERS
SEE PAGE 3 FOR DETAILS

TUXEDO
Distributors LLC
Automotive Equipment & Accessories

Tuxedo Distributors LLC is a leading importer of high quality automotive repair equipment offering a full line of automotive equipment at an economical price. With our 10 satellite warehouses strategically located across the US, we offer an unparalleled competitive advantage.

Call to place order!
817.558.9337
877.558.9337 Toll Free

TWO POST LIFTS

TLT240SC-R 2,299⁹⁹
9,000lbs CAPACITY
SKU 426404

TLT240SB-R 2,199⁹⁹
9,000lbs CAPACITY
SKU 426403

- Overall Height: 151" (TLT240SC)
- Overall Width: Symm 134", Asymm 140" (TLT240SC)
- Overall Height: 113" (TLT240SB)
- Overall Width: 133" (TLT240SB)
- Rubber Door Guards
- Hose Guards
- Stackable Footpad Extensions - four 3.5"
- Dual Point Lock Release
- Heavy-Duty Arm Restraint System
- Double Telescoping Screw Pads
- Adjustable Column Width (TLT240SC)
- Standard or Rotated Asymmetric Columns (TLT240SC)



Price Does Not Include Installation or Optional Equipment as Shown

TLT210-XT-B 3,299⁹⁹
10,000lbs CAPACITY
SKU 426407

- Overall Height: 149"
- Overall Width: Symm 137", Asymm 138"
- Heavy-Duty Arm Restraint System
- Adjustable Column Height
- Adjustable Column Width
- Outer Hose Guards
- Stackable Foot Pad Extensions four 6" and four 3"
- 3 Stage Front Arms
- Rubber Door Guards
- Single Point Lock Release
- Standard or Rotated Asymmetric Arm Configuration
- Double Telescoping Screw Pads



Price Does Not Include Installation or Optional Equipment as Shown

Standard Asymmetric Arm Configuration

Rotated Asymmetric Arm Configuration

*Available in red and blue

TP9KACX 2,049⁹⁹
9,000lbs CAPACITY
SKU 426138

TP9KFX 2,049⁹⁹
9,000lbs CAPACITY
SKU 426106

- Overall Height: 143" (TP9KACX)
- Overall Width: 138" (TP9KACX)
- Overall Height: 112" (TP9KFX)
- Overall Width: 134.5" (TP9KFX)
- Chain Driven
- Dual cylinders with low friction chain rollers
- Low profile arms
- Spin Up Pads with 1-1/2" and 4" stackable drop-in height adapters
- Padded overhead shut off bar
- Powder-Coated Finish
- Rubber Door Guards



Price Does Not Include Installation or Optional Equipment as Shown

TP11KC-DX 2,849⁹⁹
11,000lbs CAPACITY
SKU 426140

- Direct "Pull" Cylinders
- Overall Height: 145"
- Overall Width: 145-1/2"
- 3 Stage Front Arms, Low Profile Arms
- Asymmetric/ Symmetric Arm Configuration
- Symmetric Columns
- Single Point Lock Release
- Rubber Door Guards
- Spin Up Pads with 2" and 4" stackable drop in Height Adapters
- Powder-Coated Finish
- Padded Overhead shut off bar



Price Does Not Include Installation or Optional Equipment as Shown

BI-SYMMETRIC™ DESIGN
Asymmetric/Symmetric arm configuration with 180 degree front arm rotation.

MOBILE COLUMN

MSC-6KLP 3,069⁹⁹
6,000 lbs
Single Column Lift
SKU 426460

- Capacity: 6,000 lbs
- Width Overall: 45-3/16"
- Height Overall: 102-3/8"
- Length Overall: 101-9/16"
- Improved Low Profile design with less than 4" minimum height!
- Pallet Style Operation
- Improved 'double telescoping' Screw Pads with 2-3/4" adjustable height!
- Pallet Jack style hydraulics to raise lift onto wheels
- Single Point Lock Release
- Powder coat paint finish
- 110VAC / PN



Price Does Not Include Vehicles, Installation or Optional Equipment as Shown

SERVICE / ALIGNMENT LIFTS



FP14KA-C 5,549⁹⁹
14,000lbs CAPACITY
SKU 426440

- Overall Length: 250-1/2"
- Overall Width: 136-3/4"
- Width Between Post: 110"
- Column Height: 185"
- Lifting Height: 68-7/8"
- Base Plate Dimensions: 12" x 12"
- Closed Front
- Cable Driven
- Pneumatic Single Point Lock Release
- 3 each Turntable Positions

Bridge Jacks sold separately

Price Does Not Include Installation or Optional Equipment as Shown



FP14K-C 5,099⁹⁹
14,000lbs CAPACITY
SKU 426438

- Overall Height: 68-7/8"
- Overall Width: 136-3/4"
- Overall Length: 250-1/2"
- Cable Driven
- Closed Front
- Single point pneumatic safety release
- 20" wide non-skid, diamond plate runways
- Mounting Hardware included
- Powder-Coated Finish

Price Does Not Include Installation or Optional Equipment as Shown

Bridge Jacks sold separately

BRIDGE JACK



RAJ-8K-L 1,499⁹⁹
8,000lbs CAPACITY
SKU 426452

- Universal Roller Body Design w/dual 'spring loaded' precision roller bearing and Side Guide Wheels w/adjustable Height for Low, Medium, and High Jack Rail Configurations
- Rolls on top edge of Jack Rail for smooth maneuverability
- Dual Height Telescoping Support Arms
- Pneumatic operation w/adjustable Pressure Regulator
- Stackable Pad and Height Adapters 1 5/16" and 5" (1 Pair each)
- Dual Air Bags

Price Does Not Include Installation or Optional Equipment as Shown

TUXEDO

TP15KCX 4,639⁹⁹
15,000lbs CAPACITY
SKU 426389

- Overall Height: 180"
- Overall Width: 148"
- Chaindrive
- Padded Overhead shut-off bar
- Dual Point Lock Release
- Large 2' x3' Base Plates for Stability
- Rubber Door Guards
- Hose Guards
- Low Pad Height 5"
- Spin-Up Pads w/ 3" and 5" Stackable Drop-In Adapters
- Heavy Duty Arm Restraints
- Powder-Coated finish



Price Does Not Include Installation or Optional Equipment as Shown

HEAVY DUTY MOBILE COLUMN

MSC-18K-X-6108 40,699⁹⁹
18,000lbs CAPACITY
108K HD Mobile Column-6
SKU 942101

MSC-18K-X-472 27,399⁹⁹
18,000lbs CAPACITY
72K HD Mobile Column-4
SKU 942100

MSC-18K-X-236 14,099⁹⁹
18,000lbs CAPACITY
36K HD Mobile Column-2
SKU 942099

*Batteries Not Included



MSC18KX-CRSBM 1,979⁹⁹
CROSS BEAM
SKU 942103

MSC18KX-LTVAK 1,249⁹⁹
LIGHT VEHICLE ADAPTER KIT
SKU 942105



(STANDARD PAD) (AXEL PAD) (CRADLE PAD)

MSC-FORKSPCER 719⁹⁹
FORKLIFT FORK SPACE SET
SKU 942107

MSC-FL-RAMPST 1,349⁹⁹
FORKLIFT RAMP SET
SKU 942108



Price Does Not Include Vehicles, Installation or Optional Equipment as Shown



IDEAL

DID YOU KNOW?

AutoZone® carries a full-line of lithium coin batteries and alkaline batteries.

Contact Your AutoZone Commercial Sales Manager for Details

SAFETY READING GLASSES

Designed to extend your field of vision without sacrificing safety. Offered in +1.50 to +3.50 diopter for an array of vision correction needs. The high-impact, anti-scratch lenses are ANSI compliant and provide 99.99% UV protection.

NEW

SKU	PART #	Diopter
752076	26023	+1.50
752077	26024	+2.00
752078	26025	+2.50
752086	26026	+3.00
750496	26027	+3.50

24⁹⁹



The OE Leader in Automotive Lighting

Your customers have options when choosing headlight and interior/exterior bulb performance.

SAFETY: Your customer wants to be able to see objects sooner and better, but doesn't want to pay for the top-of-the line product.

SAFETY: Our farthest downroad headlight. Your customer puts safety at a premium and frequently drives a lot at night or in dimly lit areas.

SAFETY: Your customer wants to see better while driving at night, but is looking for a more budget friendly option.



STYLE: Your customer wants their car to "look cool" or "look like HID". A great solution for the customer who likes the look of HID/Xenon but their vehicle has a halogen assembly.

STYLE: Your customer wants their car to "look cool" or "look like HID". Our whitest halogen headlight with a white-blue look in the assembly. Exclusive laser ablation technology creates even more attitude.

HID XENON / zXe HID



- Complies with SAE regulations requiring 80% brightness in 4 seconds

Miniature Replacement Bulbs



- 99% vehicle application coverage
- Longer life than BASIC bulbs

- Whiter color

- Longer life than incandescent bulbs
- Low power consumption

- ZEVO Lifetime Warranty* (see package for details)
- Superior Quality
 - Longer life than incandescent bulbs

SYLVANIA

JACKS AND HYDRAULICS

877-AZTool1
877-298-6651
 Hablamos Español
AZtool1.com



INNOVATIVE TOOLS. BETTER VALUE. QUALITY RESULTS.



3-1/2 Ton Hydraulic Floor Jack

SKU 746260 **209⁹⁹**
 24836

- Min. Height: 5-3/4" Max. Height: 19-3/4"
- Features Foot Pedal for Quick Lift
- 360° Swivel Casters for Easy Maneuvering
- Overload System Prevents Use Beyond Rated Capacity
- Weight: 81.6 Lbs.



3-1/4 Ton Low Profile Jack

SKU 757109 **249⁹⁹**
 24837

- Equipped with Rear Swivel Casters
- Min. Height: 3-1/2" Max. Height: 19-1/2"
- Low Profile Professional Quality Floor Jack for Low Clearance Vehicles
- Overload and Bypass Safety Valves
- Weight: 94.8 Lbs.



2 Ton Low Profile Jack

SKU 757041 **279⁹⁹**
 24838

- Equipped with Rear Swivel Casters
- Min. Height: 3" Max. Height: 24"
- Low Profile Professional Quality Floor Jack for Low Clearance Vehicles
- Weight: 101.2 Lbs.



These Jack Stands are Designed to Increase Your Productivity While Maintaining Safety. The Self-Locking Ratcheting Design Allows Quick and Safe Adjustments to the Height of the Stand.

3 Ton Jack Stands (Pair)

SKU 757122 **49⁹⁹**
 24852

- Min. Height: 12" - Max. Height: 17-3/4"



6 Ton Jack Stands (Pair)

SKU 757050 **79⁹⁹**
 24853

- Min. Height: 15-3/4" - Max. Height: 24-3/8"
- Recessed Saddle for a Secure Placement
- Sold in Pairs

Heavy Duty 22 Ton Axle Stands (Pair)

SKU 757098 **234⁹⁹**
 24854

- Min. Height: 12-1/4" Max. Height: 19-3/4"
- Adjustable Pin Design
- Features Handle for Transport and Positioning
- Large V-Shaped Saddles Center Lift Points for Secure Placement



Garage Floor Jack Crossbeam

SKU 544803 **59⁹⁹**
 24833

- Compatible with Any Floor Jack That Has a 1-1/8" Diameter Saddle Stud
- Saddles Adjust from 23" to 32" on Center
- Weight Capacity at Min. - Max. Width: 3,000 Lbs. - 4,000 Lbs.



1/2 Ton Capacity Vehicle Dollies

SKU 757086 **99⁹⁹**
 24857

- 1,000 Lbs. Capacity
- Heavy Duty Swivel Casters for Easy Movement
- Durable Steel Construction
- Features Rails on Each Side for Easy Transport
- Sold in Pairs



AC Hydraulic^{A/S}
 NO COMPROMISE

10 YEAR
3 YEAR
 UNLIMITED
 WARRANTY

Just as our products offer high performance and quality, so does our warranty. The immense amount of workmanship, testing, and precision engineering that each of our products receives enables us to maintain our high quality. Our long warranty is our way of showing you can trust our quality.



2.2 Ton Hydraulic Jack

SKU 765533 **399⁹⁹**
 ACHDK20Q

- Minimum Height: 3.15"
- Durable High-Strength Steel Frame
- Manual Dead Man's Release for Optimal Safety when Lowering
- Built-in Safety Overload Valve
- Noiseless Wheels
- Equipped with Quick-Lift Pedal
- Maximum Height: 19.5"



DK13HLQ Long Reach Hydraulic Jack

SKU 762485 **599⁹⁹**
 ACHDK13HLQ

- 2,900 Lbs. Capacity
- Ideal for Cars with Low Clearance
- Minimum Height of Only 3.15"
- Durable High-Strength Steel Frame
- Equipped with Quick-Lift Pedal
- Manual Dead Man's Release
- Built-in Safety Overload Valve
- Noiseless Wheels
- Maximum Height: 28.9"



DK20HLQ 2.2 Ton Long Reach Hydraulic Jack

SKU 762499 **799⁹⁹**
 ACHDK20HLQ

- High-Lifting Jack Ideal for SUVs and Vans
- Minimum Height: 3.15"
- Durable High-Strength Steel Frame
- Equipped with Quick-Lift Pedal
- Manual Dead Man's Release
- Built-in Safety Overload Valve
- Noiseless Wheels
- Maximum Height: 31.3"



WJN5 Hydraulic Workshop Crane

SKU 804587 **799⁹⁹**
 ACHWJN5

- 1,200 Lbs. Capacity
- Foldable within Seconds for Quick and Easy Storage
- Hard Chromium Plated Piston Rod and Pump Piston for Long Life
- Built-in Safety Overload Valve
- Lifting Hook Pivots 360°
- Hand-Operated Dead-Man's Control



VL6 Hydraulic 600 Lbs. Transmission Jack

SKU 804488 **519⁹⁹**
 ACHVL6

- Pedal Operated Pump for Hands-Free Use
- Precise Adjustment for Positioning of Transmission
- Hand-Operated Dead-Man's Control for Optimal Safety While Lifting and Lowering
- Galvanized Support Saddle and Base Frame
- Built-in Safety Overload Valve
- Sturdy Swivel Casters for Optimal Stability and Maneuverability
- Hard Chromium Plated Piston Rod and Pump Piston for Long Life

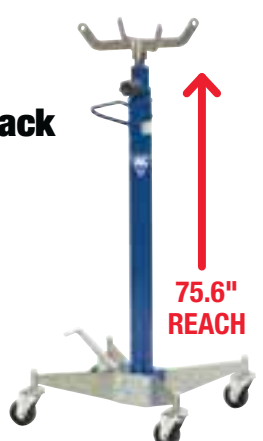

SAVE
\$200

Portable 11 Ton Air Hydraulic Jack

SKU 765557 **1,699⁹⁹** REG. 1,899.99
 ACHB25-2

- Minimum Height: 6.38"; Weight: 60 Lbs.
- Hard Chromium Plated Piston Rod for Long Life
- Built-in Safety Overload Valve
- Hand-Operated Dead-Man's Control
- 2 Extensions (1.97"/3.94") for Max. Height of 18.5"



Offer Good Through March 31, 2019 - While Supplies Last

JACKS AND HYDRAULICS

SAVE \$20 ON OEMTOOLS
800 LBS. LOW PROFILE
TRANS. JACK - 24843

Transmission Jacks

1,000 Lbs. Telescopic Transmission Jack

SKU 544786
24840

199⁹⁹

- Lift Range: 51" - 70"
- Adjustable Saddle with Tilt in Both Directions
- Durable Steel Casters
- Safety Tie-Down Chain to Secure the Load



70" REACH

1,100 Lbs. High Lift Transmission Jack with Foot Pump

SKU 750006
24844

329⁹⁹

- Lift Range: 47" - 77"
- Adjustable Saddle with Tilt
- Spring-Loaded Release Valve Controls Lowering
- Durable Steel Casters



77" REACH

1/2 Ton Capacity Transmission Jack

SKU 902481
RANRTJ1100

349⁹⁹

- Lifting Capacity: 1,100 Lbs.
- Lowered Height: 45"
- Raised Height: 72"



72" REACH

1 Ton, 2 Stage Transmission Jack

SKU 544788
24842

619⁹⁹

- Lift Range: 33.5" - 72.5"
- 3 Way Adjustable Saddle Slides and Tilts Both Directions
- Convenient Foot Pedal Pump and Release
- Safety Anchor Chain Included



72-1/2" REACH

1 Ton Telescoping Transjak™

SKU 902478
RANRTJ1

639⁹⁹

- Capacity First Stage: 2,000 Lbs.
- Capacity Second Stage: 1,000 Lbs.
- Lowered Height: 37"
- Raised Height: 71"



71" REACH

1-1/2 Ton Telescoping Transmission Jack

SKU 902484
RANRTJ3000

749⁹⁹

- Capacity First Stage: 3,000 Lbs.
- Capacity Second Stage: 2,000 Lbs.
- Lowered Height: 35-1/2"
- Raised Height: 71-1/2"



71-1/2" REACH

VLT12 Hydraulic 1.3 Ton Transmission Jack

SKU 804510
ACHVLT12

1,699⁹⁹

- Designed for Lifting Heavy Truck Transmissions
- Pedal Operated Pump with Built-in Quick Lift for Hands-Free Use
- Precise Adjustment for Positioning of Transmission
- Hand-Operated Dead-Man's Control for Optimal Safety While Lifting and Lowering
- Galvanized Support Saddle and Base Frame
- Built-in Safety Overload Valve
- Raised Height: 75-1/2"

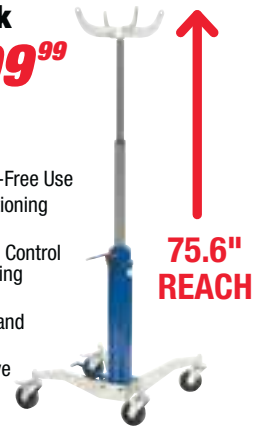

75.6" REACH

AC Hydraulic AS3 Gearbox Saddle

SKU 804521
ACHAS3

959⁹⁹

- Capacity: 2,200 Lbs.
- Dimension: 21.34 x 15.16 x 4.33 In.
- 10° Tilt in All Directions for Accurate Dismounting and Re-Mounting of Gearboxes
- Fitted with 2 Straps and 4 Magnetic Rubber Support Blocks
- Fits: GD-1, GGD, GDT, VL10, VLT6 and VLT12



10 YEAR
3 YEAR UNLIMITED WARRANTY

Fuel Tank Adapter for Transmission Jacks

SKU 222503
DOWJDI-FTA7

189⁹⁹

- Safe and Convenient Adapter for Handling Vehicle Fuel Tanks
- Works with Most Transmission Jacks

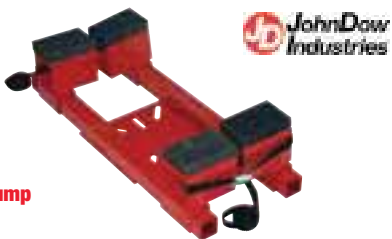

The Professional Choice for Safe Fuel Tank Removal and Fuel Pump Service. Mounts Easily on Most Transmission Jacks.

DID YOU KNOW?

AutoZone® offers a full line of bulk replacement hose clamps.

Contact Your AutoZone Commercial Sales Manager for Details

Air Hydraulic Jacks

20 Ton Air Hydraulic Bottle Jack

SKU 544795
24850

129⁹⁹

- Can Be Operated with Air or Manually
- Height: 10.25" - 20"
- Extension Screw Adjustment: 3.25"



22 Ton Air Hydraulic Truck Jack

SKU 544796
24851

469⁹⁹

- Compact, Low Profile Design Easily and Safely Fits Between Wheels of Tandem Axle Vehicles
- Min. Height: 8-1/2"
- Max. Height: 17-3/4"
- Ram Travel: 4-3/4"
- Extension Screw Adjustment: 4-1/2"



Floor Style Transmission Jack

800 Lbs. Low Profile Transmission Jack

SKU 544789
24843

329⁹⁹

- Lift Range: 8-1/4" to 30-1/2"
- Fully Adjustable Saddle Adapts to Most Transmission Pans
- Swivel Saddle Adjusts Both Directions
- 4 Swivel Ball Bearing Casters for Ease of Mobility



SAVE \$20

Offer Good Through March 31, 2019 - While Supplies Last

Wheel Dollies

Set of 4 Vehicle Position Jacks with Storage Cradle

SKU 696485
68986

649⁹⁹

- Includes (4) Position Jacks with Storage Stand
- Move a Vehicle (Up to 6,000 Lbs.) with Ease
- Adjusts 3.25"



Two 1,500 Lbs. Vehicle Position Jacks

SKU 298098
24855TWO

299⁹⁹

- Hydraulic Ram Provides Stable Foot Pedal Lift in Seconds
- Rolls in Any Direction

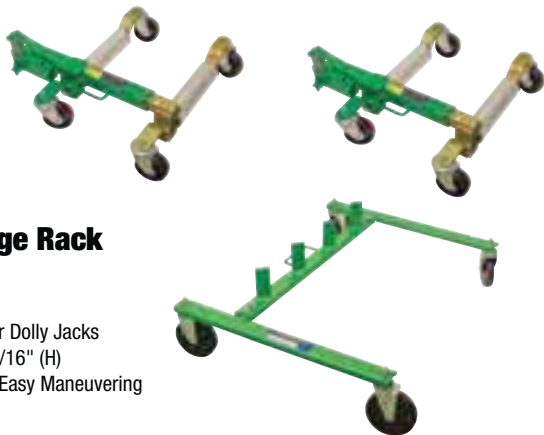

Vehicle Position Jack Storage Rack

SKU 544800
24856

69⁹⁹

- Neatly Secure and Store Up to (4) Vehicle Car Dolly Jacks
- Dimensions: 24-7/8" (L) x 31-7/8" (W) x 9-9/16" (H)
- 5" x 1" 360° Swivel Ball Bearing Wheels for Easy Maneuvering
- Weight Capacity: 300 Lbs.

Rechargeable All-in-One EMERGENCY TOOL

- Powered By a Rechargeable 12,000 mAh Lithium-ion Battery
- Holds Charge for 6 Months

SKU 012672 | 24468

307⁹⁹



TIRE INFLATOR

Quickly Inflates Tires with 1.2 SCFM

3 TON JACK

3 Ton Jack Lifting Range: 7.25" to 14.25"

Simply Position the Jack and Activate - No Manual Labor



3 MODE LIGHT

Features a Powerful LED Flashlight with 3 Modes: Normal, Strobe and SOS



JUMP START

Jump Start Your Vehicle with 200 Cold Cranking Amps and 400A of Peak Current





FREE OVERNIGHT SHIPPING
WITH MOST ORDERS
SEE PAGE 3 FOR DETAILS

Engine Stands

1,000 Lbs. Engine Stand

SKU 757115
24839 **109⁹⁹**

- Adjustable Mounting Arms to Fit Most Engine Configurations
- Locking Head Plate with 360° Engine Rotation
- Tubular Steel Construction



1,250 Lbs. Engine Stand

SKU 462493
24829 **139⁹⁹**

- Easy-to-Move and Rotate
- Heavy Gauge Square Steel Tube Frame
- Extra Wide 4 Wheel Base Provides Added Stability
- 360° Rotation
- Lock Pin Locks Engine into Position
- Includes Tool Tray



Color May Vary

1 Ton Folding Engine Stand

SKU 544804
24834 **199⁹⁹**

- Folds Upright to Conserve Valuable Floor Space
- Sturdy, Wide Base Design to Prevent Tipping Under Load
- Slotted Adjustable Saddle Permits Quick and Easy Installation
- Head Swivels 360° to Easily Position Engine



1,250 Lbs. Rotating Engine Stand

SKU 757103
24846 **389⁹⁹**

- Adjustable Mounting Arms to Fit Most Engine Configurations
- Locking Head Plate with 360° Engine Rotation
- Tubular Steel Construction
- Folding Legs for Easy Storage
- Heavy Duty Worm Gear for Effortless Rotation



OEM TOOLS™

Body Repair

OEM TOOLS™

4 Ton Fast Action Body Repair Kit

SKU 301327
24820 **129⁹⁹**

- Repair Kit Includes: Hydraulic Pump, Hydraulic Ram, Four Extension Rods, a Rubber Ball Foot, and a Duckbill Hydraulic Spreader
- Also Includes: Snap Couplings, Threaded Connectors, and 6 Feet of Hydraulic Hose and a Variety of Attachments



10 Ton Fast Action Body Repair Kit

SKU 301328
24821 **199⁹⁹**

- Repair Kit Includes: Hydraulic Pump, Hydraulic Ram, Four Extension Rods, a Rubber Ball Foot, and a Duckbill Hydraulic Spreader. Also Includes: Snap Couplings, Threaded Connectors, and 6 Feet of Hydraulic Hose and a Variety of Attachments

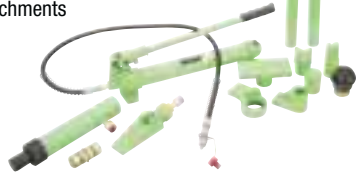

Under Hoist Stands

OEM TOOLS™

1,500 Lbs. High Reach Jack Stand

SKU 757043
24848 **109⁹⁹**

- Min. Height: 53-1/2"
- Max. Height: 80-1/4"
- Provides Added Support During Installation/Removal of Automotive Components
- Compact Design for Use in Limited Workspaces
- Durable Heavy Gauge Steel Construction



OEM TOOLS™

1,500 Lbs. High Reach Jack Stand with Foot Pedal

SKU 757078
24847 **134⁹⁹**

- Min. Height: 52-1/2"
- Max. Height: 81-7/8"
- Provides Added Support During Installation/Removal of Automotive Components
- Foot Pedal Pump Saves Time Adjusting Load
- Compact Design for Use in Limited Workspaces
- Durable Heavy Gauge Steel Construction



OEM TOOLS™

2 Ton Underhoist Jack Stand

SKU 757084
24849 **109⁹⁹**

- Min. Height: 56-1/2"
- Max. Height: 85-3/8"
- Provides Added Support During Installation/Removal of Automotive Components
- Adjustment Pin Securely Supports Load in 5 Positions
- Durable Heavy Gauge Steel Construction



Ranger

2 Ton High Tripod Jack Stands

SKU 901744
RANRJS2TH **149⁹⁹**

- Perfect for Holding Drive Train or Exhaust Components in Position
- Capacity: 4,000 Lbs.
- Low Height: 55"
- Max. Height: 87"



Engine Lifts

OEM TOOLS™

2 Ton Folding Shop Crane

SKU 544801
24830 **429⁹⁹**

- Foldable Design Makes for Convenient, Easy Storage
- 6 Solid Steel Caster Wheels Add Mobility
- Fully Adjustable 4 Position Boom



Ranger

2 Ton Folding Engine Crane

SKU 902288
RANRSC2TF **399⁹⁹**

- Heavy Duty Hydraulic Folding Engine Hoist with 8 Ton Capacity Ram is Perfect for Shops That Have Limited Space But Still Need the Pure Lifting Convenience of a Crane
- Front Casters Include a Safety Brake to Prevent Movement



AC Hydraulic™

WJN5 Hydraulic Workshop Crane

SKU 804587
ACHWJN5 **799⁹⁹**

- 1,200 Lbs. Capacity
- Foldable within Seconds for Quick and Easy Storage
- Hard Chromium Plated Piston Rod and Pump Piston for Long Life
- Built-in Safety Overload Valve
- Lifting Hook Pivots 360°
- Hand-Operated Dead-Man's Control



10 YEAR
3 YEAR UNLIMITED WARRANTY

Engine Supports

OEM TOOLS™

Engine Leveler

SKU 544802
24831 **39⁹⁹** REG. \$49.99

- Great for Use with Engine Hoist or Engine Crane
- Makes Engine Handling and Positioning Easier
- Rated Capacity: 1,600 Lbs.



SAVE \$10

Offer Good Through March 31, 2019 - While Supplies Last

1,100 Lbs. Engine Support

SKU 512946
24950 **109⁹⁹**

- 2 Screw Adjusters for Precise Positioning - Makes Job Easier, Faster and Safer
- Rubber Feet to Prevent Damage to Vehicle and Ensure Stability
- 1,100 Lbs. Capacity

2 Hooks - 2 Chains
Twice the Adjustment Means
Faster, Easier AND Safer



OEM TOOLS™

GM Engine Moving Tool

SKU 511006
THX419X **59⁹⁹**

- Fits GM Front Wheel Drive Vehicles with Engine Torque Struts
- Safely Holds Engine in Place
- Extra Bolt Holes Provide Fit on All Vehicles
- Includes Adapter 419A



THEXTON



3 Point Engine Support Bar

SKU 133617
24951 **84⁹⁹**

- Makes Removal of Transaxle Easy By Supporting Engine of Front Wheel Drive Vehicles
- Width Expands from 34-1/2" to a Full 61"
- (2) 14" Adjustable Hook Screws
- (2) 38" Braided Steel Cables
- 700 Lbs. Capacity



OEM TOOLS™

JACKS AND HYDRAULICS

OMEGALIFT™ EQUIPMENT

Magic Lift™

Patented Technology: SINGLE PUMP TO CHASSIS

LOW PROFILE SERVICE JACK & STAND COMBO



MAX.: 20"
MIN.: 3.5"

SKU 847101
PART #25055

299⁹⁹

- 2.5 Ton Magic Lift™ Service Jack
- 3 Ton Jack Stands

1-1/2 TON ALUMINUM/HYBRID SERVICE JACK*



MAX.: 14"
MIN.: 3.5"

SKU 847097
PART #26017

239⁹⁹

- Aluminum/Steel design combines lightweight and strength for longevity
- Side frame handles allow for easy carrying
- Dual piston speedy lift lightweight service jack

3 1/2 TON LOW PROFILE SERVICE JACK



MAX.: 21"
MIN.: 4"

SKU 847107
PART #29038

339⁹⁹

- Innovative Magic Lift™ design offers a quick lift for professional performance

3 TON HYD. ALUMINUM JACK



MAX.: 18.13"
MIN.: 4"

SKU 847102
PART #26030

449⁹⁹

- All aluminum structure provides strength and stability
- Side frame handles allow for easy carrying

*NO Magic Lift™ FUNCTION

OMEGALIFT™ EQUIPMENT

PREMIUM AUTOMOTIVE LIFT EQUIPMENT

22 TON AIR RETURN AXLE JACK

- Compact, low profile design for maximum access, which fits easily and safely between wheels of tandem axle vehicle
- Large steel wheels for easy positioning and smooth motion

SKU 202448
PART #23226

1,999⁹⁹

MAX.: 15"
MIN.: 9.88"

22 TON TRUCK STANDS PIN STYLE

- Sturdy, welded steel construction for superior safety and strength
- Heavy gauge, steel frame helps prevent distortion or twisting

SKU 964651
PART #32225B

259⁹⁹

MAX.: 19.63"
MIN.: 12"

6 TON HEAVY DUTY JACK STANDS

SKU 964647
PART #32065B

114⁹⁹

MAX.: 24.13"
MIN.: 15.5"

- Sturdy, welded steel construction for superior safety and strength
- Counter-weighted pawl serves as a safe, secure locking device to prevent the load from accidentally disengaging

1,000 LBS. 2 STAGE TRANS. JACK

SKU 222744
PART #41000C

1,499⁹⁹

MAX.: 77.25"
MIN.: 39.88"

- Two-stage chrome-plated rams maximize its high reach operated by a user-friendly foot pedal
- Unique release pedal provides safety in lowering the load

8 GALLON OIL DRAIN

SKU 220406
PART #89001

112⁹⁹

- For collecting fluids that include motor oil, transmission fluid and coolant, water, and water based chemicals from lifted vehicles
- Easily adjustable from ~48 1/2" to 63"
- Durable, high-density polyethylene reservoir with bottom release valve
- 4 high quality 2" casters for easy maneuverability

20 TON AIR BOTTLE JACK, FORGED BASE

SKU 12650
PART #18204C

299⁹⁹

- Effortless air operation will greatly reduce operator fatigue and speed up the efficiency of garage work



MAX.: 76.75"
MIN.: 67"

2 TON TRIPOD AUXILIARY STAND

SKU 818750
PART #33020

199⁹⁹

- Fast and safe technology for professional mechanics
- Ideal to support the exhaust system, shock absorber and other vehicle components during under vehicle repair

400 LBS. CAPACITY LOW PROFILE CREEPER

SKU 939034
PART #91400

112⁹⁹

- Low profile design for extra work space
- Six swivel casters for ease of use and mobility
- Thick padded cushions for extended comfort

Z-CREEPER 450 LBS. CAPACITY

SKU 964657
PART #91000

99⁹⁹

- Thick padded cushions for extended comfort
- Fully upholstered pad
- Six swivel casters for ease of use and mobility

WHEEL ARMS

- The wheel arm holds the tire at lift arm height and is handy with tire rotations and brake jobs.
- Easy and safe for mechanics to put on or take off tires from the vehicle.
- Avoid bending over to put down or pick up a tire.

SKU 573207
PART #92100

99⁹⁹



36" PLASTIC CREEPER

- Ergonomic lightweight HDPE body
- 300 lbs. capacity
- 6 Oil resistant 2" swivel casters
- Padded head rest
- Easy carry handle

SKU 202399
PART #91900

59⁹⁹



TOOLBOX CREEPER

SKU 250704
PART #92450

99⁹⁹

- 450 lbs. Rated capacity
- Steel frame construction
- Extra thick seat cushion



2 IN 1 SEAT-STOOL COMBO

SKU 939028
PART #91305

99⁹⁹

- Rated seat Capacity: 350 lbs.
- Rated Step Stool Capacity: 400 lbs.
- Patent Pending rolling seat with built in stool
- Tool Tray included



HEAVY DUTY TOOL CART SLIDING TOP AND LOCKING DRAWERS

SKU 203992
PART #97431

239⁹⁹

- Locking tool box with sliding top
- Unique design allows the top to be used as a work bench
- 2 drawers and 1 base shelf for tool storage
- Maneuvers easily around the shop or work area



MEETS ASME PASE 2014 SAFETY STANDARDS

CUSTOMER SERVICE (888)332-6419

DID YOU KNOW?

STP oil is now available at AutoZone®. STP is a worldwide name that customers know and trust. Buy your STP oil and filters at your local AutoZone store.

Contact Your AutoZone Commercial Sales Manager for Details

877-AZTool1
877-298-6651
 Hablamos Español
AZtool1.com

HEIN-WERNER AUTOMOTIVE

ALL HEIN-WERNER PRODUCTS CARRY A TWO YEAR MANUFACTURER'S WARRANTY.

3 TON JACK STANDS
 SKU 964601
 PART #HW93503 **79⁹⁹**

MAX.: 19"
 MIN.: 12.13"

- Dual purpose handle serves as carry handle and saddle column release



6 TON JACK STANDS
 SKU 964621
 PART #HW93506 **164⁹⁹**

MAX.: 25.75"
 MIN.: 16.25"

- Dual purpose handle serves as carry handle and saddle column release



2 TON SERVICE JACK
 SKU 964622
 PART #HW93642 **499⁹⁹**

MAX.: 20"
 MIN.: 4.5"

- U-joint release mechanism for precise load control
- Assembled in the US with US and global components



3 TON SERVICE JACK
 SKU 964623
 PART #HW93652 **589⁹⁹**

MAX.: 23.5"
 MIN.: 5.25"

- In-line pump assembly assures long life and no off-center forces for ease in pumping, aligning and reduction of wear
- U-joint release mechanism for precise load control



10 TON AIR/MANUAL LONG CHASSIS SERVICE JACK
 SKU 964626
 PART #HW93662 **3,499⁹⁹**

- Lifting trucks, trailers, and buses by the axle, differential, or frame
- Dual piston action provides speed to contact and power to lift
- Long chassis for hard to reach points



MAX.: 25.50"
 MIN.: 6.50"



4 TON AIR/MANUAL LONG CHASSIS SERVICE JACK
 SKU 964627
 PART #HW93667 **2,999⁹⁹**



- Dual piston action provides speed to contact and power to lift
- Handle adjusts to three pumping positions
- T handle with release knob for ease of positioning and load control

MAX.: 26.5"
 MIN.: 5.5"



1 TON TRANS. JACK
 SKU 964631
 PART #HW93718 **2,699⁹⁹**

- Wishbone design allows unit more mobility
- Steel Tube Frame
- 360° swivel casters

MAX.: 45.25"
 MIN.: 10.25"



2 1/2 TON END LIFT
 SKU 964629
 PART #HW93696A **1,999⁹⁹**

- Lifts the front or rear end of cars, vans, and light trucks
- Air operation with two-stage air valve
- Hydraulic damper and safety locks



MAX.: 35.38"
 MIN.: 11"



- Compact, powerful design quickly lifts rated capacity
- Large 8" rubber wheels
- Specially coated ram prevents rust and extends jack life
- 3" extension INCLUDED



MAX.: 19.75"
 MIN.: 9"



10 TON AIR OPERATED END LIFT
 SKU 964628
 PART #HW93690 **4,499⁹⁹**

MAX.: 46"
 MIN.: 12.5"

- 2-12" pneumatic rear tires and 2-6" casters for easier transport and positioning under load
- Less maintenance with one large cylinder
- Longer reach



THE BONE-STER™ MECHANICS CREEPER
 SKU 972430
 PART #4031 **99⁹⁹**

- 100% American Made
- 3" Diameter wheels with gripping tires glide smoothly over shop floors
- Capacity: 400 lbs.
- Ground Clearance: 1/4"



MAX.: 7.75"
 MIN.: 6.75"

3 TON JACK STANDS
 SKU 222493
 PART #BH5030B **49⁹⁹**

- Counter-weighted pawl locks ratchet bar securely in place
- Sturdy, welded steel construction
- One piece, multi-position ductile iron ratchet bar



MAX.: 80"
 MIN.: 55"

3/4 TON AUXILIARY STAND WITH FOOT PEDAL
 SKU 300797
 PART #BH5715 **149⁹⁹**

- Foot pedal allows easy load movement
- Fast and safe product for professional mechanics



MAX.: 80"
 MIN.: 55"

3/4 TON AUXILIARY STAND
 SKU 300796
 PART #BH5710 **139⁹⁹**

- Fast and safe product for professional mechanics



3 TON GARAGE JACK COMBO
 SKU 939029
 PART #B630JS **239⁹⁹**

- Garage essentials in one convenient package
- 3 Ton capacity garage jack
- 3 Ton jack stands (pair)



MAX.: 18.5"
 MIN.: 5.5"

3 1/2 TON FAST LIFT™ SERVICE JACK
 SKU 344792
 PART #B6350 **249⁹⁹**

- Innovative design of Fast Lift™ technology offers a quick lift for professional performance
- Swivel saddle provides easy jack positioning and user safety

MAX.: 20"
 MIN.: 5.25"



4 TON PORTO-POWER® KIT
 SKU 964658
 PART #B65114 **299⁹⁹**



- 4 Ton capacity gives you the pushing and spreading power you need to make fast and easy work of everyday repairs
- Snap-lock design for quick and easy assembly

10 TON PORTO-POWER® KIT
 SKU 964663
 PART #B65115 **399⁹⁹**



- The 10 Ton capacity model gives you the extra muscle you need to get the job done right
- Snap-lock design for quick and easy assembly

CUSTOMER SERVICE (888)332-6419

MEETS ASME PASE 2014 SAFETY STANDARDS

DIAGNOSTICS

Autel MaxiSYS®

MaxiSYS MS906BT Wireless Diagnostic Tablet

SKU 907266
AULMS906BT **1,469⁹⁹**

- 8" Color Touchscreen / 1.3GHz + 1.7GHz Hexa-Core Processor
- Includes Bluetooth MaxiSYS-VCI100, OBDII Connector Kit & Carry Case
- Android 4.4.2/ WiFi Updates / 1 Year Warranty & 1 Year FREE Updates
- AutoVIN 2006+ / AutoSCAN All Modules in All Systems
- Covers Domestic, Asian and European Vehicle Manufacturers (1996+)
- Reset Diesel Emissions on Select Light/Med. Duty
- 20 Service Functions w/ ABS Brake Bleed
- Bi-Directional / Enhanced Mode 6 / DPF Regeneration
- Coding & Adaptations / Key Programming Domestic & Asian 2001+



MaxiSYS® Diagnostic Tablet with TPMS

SKU 288495
AULMS906TS **1,994⁹⁹**

- Uniquely Integrated TPMS Service Application Designed for Triggering Known OEM TPMS Sensors
- 8" Color Touchscreen / 1.3GHz + 1.7GHz Hexa-Core Processor
- Includes Bluetooth MaxiSYS-VCI100, OBDII Connector Kit & Carry Case
- Android 4.4.2/ WiFi Updates / 1 Year Warranty & 1 Year FREE Updates
- Pre & Post SCAN Insurance Carrier Ready Diagnostic Reports with ADAS Identification
- Complete TPMS / OBDII Relearn / Placard Value Reset on Select Vehicles
- AutoVIN 2006+ / AutoSCAN All Modules in All Systems
- Covers Domestic, Asian and European Vehicle Manufacturers (1996+)
- 20 Service Functions w/ ABS Brake Bleed
- Bi-Directional / Enhanced Mode 6 / DPF Regeneration
- Coding & Adaptations / Key Programming Domestic & Asian 2001+



Bluetooth Communication

MaxiSYS® MS908S Wireless Diagnostic Tablet w/ Bluetooth

SKU 938037
AULMS908S **2,899⁹⁹**

- 10" Color Touchscreen / 1.3GHz + 1.7GHz Hexa-Core Processor
- 64GB SSD & 2GB RAM
- Android 4.4.2/ WiFi Updates / 1 Year Warranty & 1 Year FREE Updates
- AutoVIN 2006+ / AutoSCAN All Modules in All Systems
- Covers Domestic, Asian and European Vehicles (1996+) Including Supercars
- Reset Diesel Emissions on Select Light/Med. Duty Vehicles
- 21 Service Functions w/ ABS Brake Bleed
- Bi-Directional / Enhanced Mode 6 / DPF Regeneration
- Advanced Coding & Adaptations / Key Programming Domestic & Asian 2001+
- Includes Bluetooth MaxiSYS-VCI, OBDII Connector Kit & Carry Case



J-2534 Pass-Thru Device

SKU 005455
AULMF2534 **1,094⁹⁹**

- Upgrades Maxisys to a Maxisys Pro
- Built-in Wireless Capability and Data Storage
- Internet Upgradable and Updateable



MaxiSYS® MS908SPro Wireless Diagnostic Tablet w/ Bluetooth

SKU 938038
AULMS908SPRO **3,599⁹⁹**

- 10" Color Touchscreen / 1.3GHz + 1.7GHz Hexa-Core Processor
- 64GB SSD & 2GB RAM
- Android 4.4.2/ WiFi Updates / 1 Year Warranty & 1 Year FREE Updates
- AutoVIN 2006+ / AutoSCAN All Modules in All Systems
- Covers Domestic, Asian and European Vehicles (1996+) Including Supercars
- Reset Diesel Emissions on Select Light/Med. Duty Vehicles
- 21 Service Functions w/ ABS Brake Bleed
- Bi-Directional / Enhanced Mode 6 / DPF Regeneration



- Advanced Coding & Adaptations / Key Programming Domestic & Asian 2001+
- Includes J2534 MaxiFlash Elite, OBDII Connector Kit & Carry Case

MS908E MaxiSYS® Elite Diagnostic Tablet

SKU 766664
AULMS908E **3,794⁹⁹**

- 10" Color Touchscreen / 1.8GHz Quad-Core Processor
- Android 4.4.4/ WiFi Updates / 2 Year Warranty & 2 Years FREE Software
- AutoVIN 2006+ / AutoSCAN All Modules in All Systems
- Covers Domestic, Asian and European Vehicles (1996+) Including Supercars
- Bi-directional / Enhanced Mode 6 / DPF Regeneration
- 21 Service Functions w/ ABS Brake Bleed
- Advanced Coding & Adaptations / Key Programming Domestic & Asian 2001+
- Includes J2534 MaxiFlash Elite, Bluetooth MaxiSYS-VCI100, Docking/Charging Station, OBDII Connector Kit & Carry Case



1-Year Updates

MS906 SKU 306358 AULMS9061YR 494⁹⁹	MaxiSYS® Mini MS905 SKU 848003 AULMS905-1YRUP 689⁹⁹	MS908 SKU 079901 AULMS908-1YR 729⁹⁹	MS906TS SKU 306460 AULMS906TS1YR 794⁹⁹	MS908P SKU 079925 AULMS908P-1YR 1,199⁹⁹	MS908CV SKU 306445 AULMS908CV1YR 1,294⁹⁹	MSELITE SKU 306357 AULMSELITE1YR 1,294⁹⁹
--	---	---	--	---	--	--



AUTEL
AUTOMOTIVE INTELLIGENCE

Autel MaxiTPMS®

MaxiTPMS® Pad

SKU 757075
AULTPMSPAD
79⁹⁹



Programming Accessory Device

MaxiTPMS® TS408

SKU 868617
AULTS408
199⁹⁹



TPMS Service Tools

MaxiTPMS® TS508K

SKU 769090
AULTS508K
674⁹⁹



Complete TPMS Service Tool / Includes 8 Programmable Universal Sensors

MaxiTPMS® TS608

SKU 769120
AULTS608
849⁹⁹



All Service and Complete TPMS

AUTEL
AUTOMOTIVE INTELLIGENCE

	AULTPMSPAD	AULTS408	AULTS508K	AULTS608
Sensor Programming	Autel MX-Sensors	Autel MX-Sensors	Autel MX-Sensors	Autel MX-Sensors
Read / Activate / Relearn	Read	Read / Activate	Read / Activate / Relearn	Read / Activate / Relearn with OBDII Relearn Assist
OBDII Connection	NA	NA	OBDII Cable Connection	Wireless OBDII VCI
Operating System	NA	NA	NA	4.4.2 Android OS
Processor	NA	NA	NA	1.6 GHz Quad-Core
Advanced Diagnostics	NA	NA	NA	Yes
Screen	NA	320 x 240 DPI, TFT Color LED Display	320 x 240 DPI, TFT Color LED Display	1024 x 600 DPI, 7" Color Touch Screen
Battery	USB Cord Power	3200 mAh Battery	3200 mAh Battery	5000 mAh Battery
Free Updates	Free Lifetime Updates via PC	Free Lifetime Updates via PC	Free Lifetime Updates via PC	Wireless OBDII MaxiSYS-VCI/MINI

Universal Programmable MX-Sensors

315MHz / 433MHz Universal Programmable MX-Sensors

- Compatible to Replace 98% of OE Sensors / Meets SAE Standards J1205 & J1206
- Rubber valve Stems Interchangeable with Metal Valve Stems or Color Valve Stems
- Re-programmable / Exclusive Press Release Button

MX-Sensor Rubber Valve Press-In Sensor

SKU 757121 315MHz
AULMXSNS315RP **39⁹⁹**

SKU 757079 433MHz
AULMXSNS433RP **39⁹⁹**

SKU OUTSIDE BUY/EPO 315MHz
AULMXSNS315MP **39⁹⁹**

SKU OUTSIDE BUY/EPO 433MHz
AULMXSNS433MP **39⁹⁹**



AUTEL
AUTOMOTIVE INTELLIGENCE

Available via Outside Buy/EPO, Call 1-877-298-6651 for Ordering Instructions



FREE OVERNIGHT SHIPPING
WITH MOST ORDERS
SEE PAGE 3 FOR DETAILS

Autel Diagnostic Tools

MaxiCheck® MX808

SKU 868605
AULMX808 **509⁹⁹**

- Read/Clear Codes for All Available Systems
- Display Live Data In Text, Graph & Analog for Easy Data Review
- Auto VIN Technology Automatically Identifies Make, Model and Year Information
- Relearn Parking Brake Pad After Replacement
- Supports Forced DPF Regeneration and Adjusting Injectors
- Reset Steering Angle Sensor (SAS)
- Reset Service Mileage and Service Intervals
- Supports TPMS Sensor Relearn
- Supports Battery Registration and Reset



AUTEL
AUTOMOTIVE INTELLIGENCE



AutoLink® AL329 Scan Tool

SKU 868601
AULAL329 **49⁹⁹**

- Read/ Erase Engine DTCs
- Updates via PC / FREE Lifetime Software & 1 Year Warranty
- Covers Domestic, Asian and European Vehicle Manufacturers (1996+)
- One Click I/M Readiness / LED Indicator
- Display Live & Freeze Frame Data
- Includes OBDII Cable



AutoLink® OBDII and Electrical Test Tool

SKU 222487
AULAL439 **119⁹⁹**

- Read/ Erase Engine DTCs
- Updates via PC / FREE Lifetime Software & 1 Year Warranty
- Covers Domestic, Asian and European Vehicle Manufacturers (1996+)
- Supports All 10 OBDII Test Modes / Display Live & Freeze Frame Data
- One Click I/M Readiness / LED Indicator
- Tests Starting, Circuit, Voltage, Resistance & Charging Systems
- Includes Voltage Test Probes & AVO Meter, OBDII 16-Pin Cable



AutoLink® AL529 Scan Tool

SKU 868678
AULAL529 **119⁹⁹**

- Read / Erase DTCs for ABS/ SRS/ Engine
- Updates via PC / FREE Lifetime Software & 1 Year Warranty
- Covers All Domestic, Asian and European Vehicle Manufacturers (1996+)
- AutoVIN 2006+ Manufacturer-Specific Codes
- Graph, Record & Playback Live Data / Live & Freeze Frame Data
- Support All 10 OBDII Test Modes / Enhanced Mode 6 Diagnostics
- I/M Readiness/ Emissions Testing
- Tests: O2 Monitor, On-Board Monitor & Oxygen Sensor
- Includes OBDII Cable



Reads Live Data

Autel AL609P Code Reader

SKU 868472
AULAL609P **119⁹⁹**

- Read/ Erase Engine DTCs / Includes Voltage Test Probes & AVO Meter, OBDII Cable
- Updates via PC / FREE Lifetime Software & 1 Year Warranty
- Covers Domestic, Asian and European Vehicle Manufacturers (1996+)
- Support All 10 OBDII Test Modes / Live & Freeze Frame Data
- One Click I/M Readiness/ LED Indicator
- Tests: Starting, Circuit, Voltage, Continuity, Current & Charging Systems
- I/M Readiness/ Emissions Testing
- Tests: O2 Monitor, On-Board Monitor & Oxygen Sensor
- Includes OBDII Cable



AutoLink® Enhanced OBDII and Electrical Test Tool

SKU 222509
AULAL539 **179⁹⁹**

- Read/ Erase Engine DTCs
- Updates via PC / FREE Lifetime Software & 1 Year Warranty
- Covers Domestic, Asian and European Vehicle Manufacturers (1996+)
- Support All 10 OBDII Test Modes / Live & Freeze Frame Data
- One Click I/M Readiness / LED Indicator
- Tests: Starting, Circuit, Voltage, Continuity, Current & Charging Systems
- Includes Voltage Test Probes & AVO Meter, OBDII Cable



AutoLink® AL629 Scan Tool

SKU 868603
AULAL629 **189⁹⁹**

- Read / Erase DTCs for ABS, SRS, Engine & Transmission
- Updates via PC / FREE Lifetime Software & 1 Year Warranty
- Covers Domestic, Asian and European Vehicle Manufacturers (1996+)
- AutoVIN 2006+ Manufacturer-Specific Codes
- Graph, Record & Playback Live Data / Live & Freeze Frame Data
- Support All 10 OBDII Test Modes / Enhanced Mode 6 Diagnostics
- I/M Readiness / Emissions Testing
- Tests: O2 Monitor, On-Board Monitor & Oxygen Sensor
- Includes OBDII Cable



Scan Tools

CanDo C-Pro 8" Tablet Scan Tool with Bluetooth & WiFi

SKU 201992
CDOC-PRO **899⁹⁹**

- Professional Scan Tool for Asian, European and Domestic Passenger Cars and Light Trucks
- Full System and Subsystem Access for Read & Clear Codes, Live Data, Bi-directional Controls and Special Functions
- Complete Factory Resets and Adaptations
- Bluetooth Android Tablet
- Remote Technician Function
- 1 Year Software Subscription

NEW

CanDo INTERNATIONAL, INC.



MaxiDiag MD808Pro

SKU 868470
AULMD808PRO **319⁹⁹**

- 4 In. TFT Color LED Display 840x480
- Updates via PC / FREE Lifetime Software & 1 Year Warranty
- AutoSCAN DTCs Detection for All Modules in All Systems
- All 10 Test Modes / Enhanced Mode 6 Diagnostics
- 6 Service Functions OLS/ EPB/ SBC/ SAS/ BMS/ DPF
- Set Inspection 1&2 Service Intervals
- I/M Readiness / Emissions Testing & DPF Regeneration
- Includes OBDII Cable



Code Buddy PRO OBDII Code Scanner

SKU 802332
ESI903 **89⁹⁹**

- Reads Live Data Stream
- Works on All 1996 and Later OBDII Compliant US, European and Asian Vehicles
- Clears Codes, Turns Off MIL and Resets Monitors
- Built-in OBDII Fault Code Lookup Library



iOBDII Code Reader

SKU 462982
CDOIOBD2 **79⁹⁹**

Wirelessly Connects to Either iPhone® or Android™ Smart Phones and Tablets via Bluetooth®

- Read and Clear Codes
- Read and Record Live Data Stream
- Read Freeze Frame Data, Vehicle Information
- O₂ Sensor Testing
- Mode 6 Testing
- Evaporative Emission System Leak Detection
- Customizable Dashboard
- Includes Many Features Not Available or Cost Extra on Other Bluetooth OBDII Adapters



Phone Not Included

TechPRO®

TechPRO® MAHLE

Driven by performance

To make the challenging job of diagnosing and servicing today's computer-controlled engines easier and more efficient, we've developed the world's SMARTest diagnostic tool: the MAHLE TechPRO Diagnostic Scan Tool. The most advanced technology available for professional technicians, this versatile, PC- or tablet-enabled tool will help you analyze, diagnose and repair today's sophisticated vehicles faster and more accurately than ever before. No more waiting for automakers to send monthly or annual updates!

VCI1000 SYSTEM Plus 8" Tablet with Preloaded Software

SKU 080072
MSS4028000400

1,899⁹⁹

VCI1000 SYSTEM Plus 10" Tablet with Preloaded Software

SKU 080027
MSS4028000600

2,229⁹⁹



MSS4028000600

Brake, Oil and Service Light Reset + Tool

SKU 793568
33627302 **245⁰⁰**

- Used to Reset Oil Service Light, Service Mileage, Service Intervals, Vehicle Inspection, Engine Oil, Front and Rear Brake, Brake Fluid, Dust Filter and Spark Plugs on Most Major Asian, American and European Vehicles
- Easy, Step-by-Step On-Screen Instructions
- Automatic or Manual Reset Option
- Includes USB Cable and OBDII Connectors
- Comes in a Blow Mold Case

OEM TOOLS™



DIAGNOSTICS



CarDAQ-Plus3 Kit

SKU 082184
DRWCDP3KIT (shown)

1,739⁹⁹

- The CarDAQ-Plus[®] 3 is the Next Generation Drew Technologies Universal Automotive Pass-Thru Device
- CarDAQ is the Most OEM Validated and Compatible Device, Making it Truly Universal
- Supports OEM Right to Repair Applications and Full Pre-R2R Applications
- Works with Vehicle Security and Key Functions When Included in the OEM Application
- The CarDAQ-Plus[®] 3 Has Future Technologies Such as FD-CAN and DOIP to Give the Device a Long Service Life
- 4 CAN Channels – Compatible with Chrysler/FCA Requirements



DRWCDP3KIT

CarDAQ-Plus3 Bluetooth Kit

SKU 082179
DRWCDP3BTKIT

1,939⁹⁹

- The CarDAQ-Plus[®] 3 is the Next Generation Drew Technologies Universal Automotive Pass-Thru Device
- CarDAQ is the Most OEM Validated and Compatible Device, Making it Truly Universal
- Supports OEM Right to Repair Applications and Full Pre-R2R Applications
- Works with Vehicle Security and Key Functions When Included in the OEM Application
- The CarDAQ-Plus[®] 3 Has Future Technologies Such as FD-CAN and DOIP to Give the Device a Long Service Life
- 4 CAN Channels – Compatible with Chrysler/FCA Requirements
- Includes Bluetooth Wireless Capability

CarDAQ-M MegaCAN Kit

SKU 082178
DRWCDCANKITA **2,099⁹⁹**

- CarDAQ-M-MegaCAN Kit is Our Universal Pass-Thru Device That is Both Hardware and Software Updateable
- CarDAQ is the Most OEM Validated and Compatible Device, Making it Truly Universal
- Modular J2534 Device That is Field Upgradable
- Includes: CarDAQ-M, MegaCAN Modules, Educational Software, Toolbox3 and Technical Support for the Life of the Tool



**Truly Universal Device,
Educational Materials and
Technical Support Included**

RAP[®] FLASH Combo Kits

Drew Technologies owns the RAP Flash KIT, offering substantial savings through pay-per-flash pricing and allowing utilization of the RAP Flash Service as needed plus self-programming with a CarDAQ unit.



- RAP[®] Flash Kit Features Do-It-For-Me Programming — RAP[®] Flash Expert Support Will Complete J2534 Programming
- Chrysler, Ford, GM, Honda, Nissan, Toyota, BMW and Hyundai/Kia Service
- \$49.95/Month Leasing Agreement for RAP[®] Flash Kit (Waived with Minimum of 2 Flashes/Month)

RAP2 CarDAQ-Plus3 Combo Kit

SKU 082236
DRWRAPCDP3KTA **2,029⁹⁹**

**RAP[®] Flash
Lease includes
Three Free Flashes
(\$375 Value)***

RAP2 CarDAQ-M MegaCAN Kit

SKU 082198
DRWRAPCDMCAN **2,389⁹⁹**

***Flashes must be used within
60 days of delivery**

Reprogrammer

MongoosePro[®] Vehicle Interfaces **499⁹⁹**

- Designed to Be a Complete J2534 Tool for a Specific Car Manufacturer
- OEM Approved
- Enables OEM ECU Diagnostics and Reprogramming
- Free Telephone and E-mail Support



Chrysler

SKU 362554 | DRWMGSCI

Ford

SKU 362553 | DRWMGFORD

GM

SKU 362555 | DRWMGGM

Toyota

SKU 362550 | DRWMGMFC



Honda

SKU 769054 | DRWMGPHONDA

VW

SKU 776168 | DRWMGPVW

Electrical Diagnostic Test Kits

Multi-Function Power/Ground Meter

SKU 300126
24366 **89⁹⁹**

**MEASURE SPARK KV,
INJECTOR FREQUENCY
AND PULSE**

- Quickly Diagnose Circuits and Test Components
- Apply Battery Voltage or Ground with a Simple Thumb Rocker Switch
- Performs Standard Multimeter Functions: Volt, Continuity and Polarity
- Includes: Meter, 20' Extension Lead, Probe Extension, Battery Clips, Cigarette Lighter Adapter, Auxiliary Ground Lead



OEM TOOLS[™]

Relay Circuit Tester

SKU 383450
27211 **139⁹⁹**

- Includes: Tester, (5) Popular Relay Leads, (1) Universal Relay Lead
- Use to Test Relay Circuits in Late Model Vehicles
- Can Also Be Used to Perform Easy Combination Tests, Fuel Pressure Tests and Jump Relay for A/C Fill
- No Need to Pierce Wire or Use Multiple Jump Leads



OEM TOOLS[™]

Power Probe III with Case and Accessories

SKU 262523
PWPPP319FTC **169⁹⁹**

- Relay and Component Tester
- Voltmeter and Continuity Tester
- Audio Tone
- Carbon Fiber Design Housing
- 20' Jumper Lead
- Works on 12-24V Sources



POWER PROBE[™]

ECT3000 Short/Open Electrical Circuit Tester

SKU 598789
PWPPPECT3000 **199⁹⁹**

- Transmitter Will Quickly Determine an Open or Short Circuit When Connected to an Isolated Circuit
- Receiver is Designed to Detect the Signal Emitted from the Transmitter Through the Vehicle's Wiring, Notifying the User of Distance and Direction with Adjustable Height Sensitivity
- 10 Minute Auto Shut-Off
- Integrated Flashlight in Receiver



POWER PROBE[™]

Power Probe IV

SKU 802331
PWPPP401AS **229⁹⁹**

- Supplies Power and Ground for Functional Component Testing
- Digital Volt and Ohmmeter for Circuit Testing
- Large Color LCD Screen with Easy to Navigate User Menu
- AC-RMS, AC Peak to Peak, Frequency and Pulse Width for Signal Testing
- Fuel Injector Tester for Easy Circuit Diagnosis
- PCM/ECM Driver Supplies Safe Voltage for Testing Circuits



POWER PROBE[™]

Master Electrical Test Kit

SKU 262524
PWPPPKIT03 **369⁹⁹**

- Includes: Power Probe III, ECT2000 and Gold Series Lead Set
- Contains Gold Series 4 mm Leads and Connectors
- Continuity, Relay and Component Tester
- Works on 12-24V Sources
- Easy-to-Read Backlit Voltmeter Reads Voltage in 1/10th Volt



POWER PROBE[™]

Inspection Cameras

MV500 Digital Video Inspection Camera w/ Tablet

SKU 938036
AULMV500 **894⁹⁹**

- 5" Color LCD Display Tablet
- Dual Front and Side Cameras for Multiple View Options
- WiFi Equipped Camera with 40" Camera Cable
- Zoom and Low Light Image Controls
- Records Digital Still Images and Videos
- Micro SD Card Slot Allows Image and Video Playback and Storage
- 3.7V Li-Po Battery for Up to 3.5 Hours of Continuous Use



AUTEL[®]
AUTOMOTIVE INTELLIGENCE

MaxiVideo[®] MV400-5.5 Digital Videoscope

SKU 222477
AULMV400-5.5 **179⁹⁹**

- 3.5" Hi-Res Color LCD Display (320 x 240)
- Removable SD Card for Images and Video
- Easy-to-Use, Multi-Language Interface
- Wide Camera Angle with 640 x 480 Resolution
- Probe Diameter of 5.5 mm



AUTEL[®]
AUTOMOTIVE INTELLIGENCE

MaxiVideo[®] MV208-5.5 Digital Videoscope

SKU 255816
AULMV208-5.5 **139⁹⁹**

- 2.4" Hi-Res Color LCD Display (320x240)
- Easy-to-Use, Multi-Language Interface
- Wide Camera Angle with 640 x 480 Resolution
- Probe Diameter of 5.5 mm



AUTEL[®]
AUTOMOTIVE INTELLIGENCE

MaxiVideo[®] MV208-8.5 Digital Videoscope

SKU 222475
AULMV208-8.5 **129⁹⁹**

- 2.4" Hi-Res Color LCD Display (320 x 240)
- Records and Plays Back Still and Video Images
- White LED Illuminates Inspection Area
- Probe Diameter of 8.5 mm
- Includes Magnet, Mirror, Hook and Storage Case



AUTEL[®]
AUTOMOTIVE INTELLIGENCE

8.5 mm MaxiVideo Inspection Camera

SKU 079977
AULMV108 **119⁹⁹**

- 8.5 mm (0.22") Diameter Image Head
- Flexible Imager Head and Cable Reach to 3.3'
- Adjustable, White LED Illuminates Inspection Area
- Waterproof Head and Cable to 10'
- USB Compatible
- Includes Magnet, Mirror, Hook Attachments

5.5 mm MaxiVideo Inspection Camera

SKU 079943
AULMV105 **139⁹⁹**

- 5.5 mm (0.22") Diameter Image Head



AUTEL[®]
AUTOMOTIVE INTELLIGENCE

Borescope with 2.4" Color LCD Screen

SKU 544746
24383 **124⁹⁹**

- Resolution: 640 x 480
- Adjustable LEDs Illuminate the Inspection Area
- 9 mm Probe
- 1 Meter Flexible Shaft
- Includes: Magnet, Mirror and Hook; All in a Blow Mold Case



OEM TOOLS[™]

DID YOU KNOW?

AutoZone® has over 100,000 Vehicle Electronic part numbers available that covers 98% of the vehicles on the road today.

Contact Your AutoZone Commercial Sales Manager for Details

877-AZTool1
877-298-6651
 Hablamos Español
AZtool1.com

Smoke Leak Detectors

Smoke Diagnostic Machine

SKU 544732
24534 **709⁹⁹**

- Helps Technicians Diagnose Trouble Codes on Domestic and Import Cars and Light-Trucks
- Tests for Oil Leaks, Wind Leaks, EGR Leaks and More
- Finds Leaks Fast
- Includes Variable Flow Control and Integrated Regulator That Detect Leaks in the System with Smoke
- Works for Turbo Systems, Engine Block, Fuel System and Exhaust Systems
- 12 Volt with Automatic Off Switch
- Works with Standard Mineral Oil



ReadySmoke™ Leak Detector

SKU 744010
RED95-0400 **799⁹⁹**

- Readysmoke™ Finds Leaks Fast and Finds More Repair Jobs on Every Vehicle
- Includes Two 2 oz OEM-Approved Vapor Producing Fluid, EVAP Service Tool Kit, Halogen Inspection Light, Cap Plug Kit, Standard Cone Adapter and Storage Case
- Compact Size Fits Securely in Your Tool Box Drawer at 6" x 7" x 7" and Under 8 Pounds
- Made in America Quality and Legendary Redline Customer Service
- Combo Gauge Measures Vacuum and Pressure in Inches of Water
- Flow Meter Identifies Minute Leaks At and Below .010" in Diameter
- Easy Fill Dipstick Style Fluid Port



Smoke Pro® Total-Tech®

SKU OUTSIDE BUY/EPO
RED95-0003C **1,249⁹⁹**

- Find ALL Types of Leaks
- Greatly Reduce Diagnostic Time
- One Simple Connection Diagnoses an Entire System in Seconds
- Eliminate Comebacks By Verifying That Leaks are Repaired Completely
- Includes Easy Intake
- 2 Year Warranty



Available via Outside Buy/EPO.
Call 1-877-298-6651 for Ordering Instructions

PowerSmoke™ Leak Detector

SKU 743985
RED95-0170 **3,299⁹⁹**

- Specifically for Light to Medium Duty Vehicles with Forced Induction Engines
- Variable Pressure Variable Flow
- 40X Typical EVAP Pressure
- Compact, Rugged Design
- Professional Grade Strong
- Made with Steel and Billet Aluminum
- Not for Use on EVAP
- Runs on Compressed Air
- Powered By 110-250V AC or 12V DC
- 2-20+ PSI Range



Intake Inflation Block Off Bladder for Use with All Smoke Machines

SKU 598274
24536 **89⁹⁹** REG. \$99.99

- Can Be Used with Any Brand of Smoke Machine or Diagnostic Leak Detector
- Conforms to Any Shape
- Intake / Exhaust: Square, Round, Oval or Rectangular
- Works with Most Automobiles and Light, Medium and Heavy Duty Trucks

SAVE \$10



Offer Good Through March 31, 2019 - While Supplies Last

Smoke Producing Fluid (8 Oz.)

SKU 802333
RED96-0039 **19⁹⁹**

- Contains No Dye or Other Contaminants
- Works in Most EVAP Smoke Machines



EasyEVAP™ Universal Filler Neck Connector

SKU 343405
RED95-0030 **129⁹⁹**

- Compatible with Any Smoke Machine and Removes Cleanly from the Gas Cap
- Essential Tool for Late Model Cars with Fuel Tank Rollover Valves



3.9" Intake Bladder

SKU 938031
RED95-0083 **389⁹⁹**

- Expandable Bladder Seals Off Intake and/or Exhaust During Diagnostic Tests on Heavy Duty, Class 7 & 8 Vehicles



Multimeters

Parasitic Drain Testing Accessory

SKU 011608
LIS64970 **24⁹⁹**

- Replaceable In-Line Fuses to Protect Meter
- Allows Tester and Meter to Remain Connected
- Stacking Banana Connectors
- Multimeter Required



Auto-Ranging Digital Multimeter

SKU 851885
ESI480A **49⁹⁹**

- 43 Test Ranges, Auto-Ranging
- 10 Test Functions
- Auto Power-Off, Data Hold
- Dual Fuse Protection
- 10 Meg/Ohm Input Impedance



Deluxe Automotive Digital Multimeter with Carrying Case

SKU 301604
ESI585K **114⁹⁹**

- Used for Diagnosing Electrical, Computer and Engine Problems
- 45 Test Ranges, 14 Test Functions, and Dual Fuse Protection
- RPM for DIS and Standard Ignitions
- RPM Pick-Up and Temperature Probe Included
- Dual Fuse Protection with Built-in Tilt Stand
- Dual Display with Analog Bar Graph and Digital Readings



Current Probe / Multimeter

SKU 489181
ESI685 **179⁹⁹**

- 35 Test Ranges with Continuity Beep
- 10 Test Functions with Overload Protection
- Heavy Duty Insulation Piercing Clips
- Automatically Powers Off
- Clamp Opening of 7/8"
- Carrying Case and 9 Volt Battery Included



Probes

Electrical Back Probe Kit

SKU 511020
THX490 **34⁹⁹**

- Kit Contains 20 Pin-Type Back Probes
- Smaller Pins for Tough-to-Test Areas
- Color Coded for Easier Testing



Extended Heavy Duty Back Probe Kit

SKU 511028
THX490X **39⁹⁹**

- Contains 8 Extended Electrical Back Probes
- Use to Access Electrical Circuits from the Back Side of the Connector
- Color Coded in 4 Variations for Easier Testing



Heavy Duty Electrical Back Probe Kit

SKU 511021
THX490-M **39⁹⁹**

- Have Longer Pin for Tough-to-Reach Circuits
- Kit Contains: (10) Straight Pins, (5) 90 Degree Pins, (5) 45 Degree Pins
- Color Coded for Easier Testing



DIAGNOSTICS

Fuel and Engine

Exhaust Back Pressure Tester/Gauge

SKU 347232 27263 **69⁹⁹**

- Oxygen Sensor Adapter is M12 and M18 Thread
- 6' Hose Allows User to Test from Driver's Seat
- Test for Restricted Exhaust Systems
- Comes in a Blow Mold Case



OEM TOOLS™

Oil Pressure Gauge Set

SKU 347229 27262 **79⁹⁹**

- For Use on Diesel and Gasoline Engines
- Includes Standard and Metric Adapters Found on Most Cars and Trucks
- 2-1/2" Easy-to-Read Gauge with Protective Boot
- Comes in a Blow Mold Case



OEM TOOLS™

Cylinder Leak Down Test Kit

SKU 347237 27267 **159⁹⁹**

- Includes: Precision Regulator with a Combination M14/M18 Adapter; 26" Hose M10, M14 and M18 Solid Long Reach Adapters; and Extra O-Rings
- Displays Leakage as a Percentage
- Comes in a Blow Mold Case



OEM TOOLS™

Fuel Pressure Test Kit

SKU 347235 27265 **109⁹⁹**

- Designed Around Quick Connect Adapters
- Includes 3-1/2" Heavy Duty Gauge with Protective Boot, Large and Small Schrader Adapters, M6-1.00 Banjo Adapter, Double End Tee for 5/16" and 3/8" and Single End Connector for 1/4", 5/16" and 3/8"
- Range: 0 - 150 PSI
- Comes in a Blow Mold Case

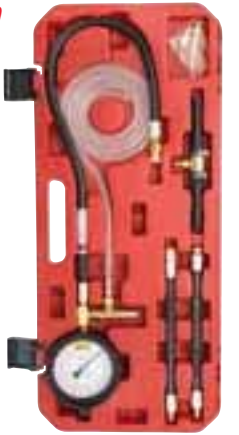

OEM TOOLS™

Fuel Injection Cleaner Kit

SKU 517582 MITMV5567 **439⁹⁹**

- Complete Fuel Injector Cleaning Kit Combining the Cleaner with Connection Hose (MV5565) and Connection Adapter Kit (MVA565)
- Can Be Upgraded to an Air Induction Cleaner By Adding MVA550 Decarb Nozzle
- Quickly and Cleanly Removes and Prevents Fuel Injector Deposits, and Loosens and Dissolves Carbon on Intake Manifold and Valves
- Enhances Engine Performance, Improves Fuel Economy, Reduces Maintenance and Improves Emission
- Uses Standard Shop Air to Deliver Cleaning Solution Directly into the Fuel Stream or Spray it into the Air Induction System (MVA550 Required for Induction System Cleaning)



Mityvac™

Fuel Pressure Test Kit

SKU 988887 MITMV5546 **469⁹⁹**

- Contains 37 Adapters for Pressure Testing Most US, Asian and European Manufactured Vehicles
- High Quality, Heavy Duty Gauge with 0 - 120 PSI (0 - 8 Bar) Scale, Protective Rubber Boot and Push Button Pressure Relief Valve
- Uses SAE Certified, Fuel-Rated Quick Connects for Reliability, Ease of Use and Interchangeability
- Easily Upgrades to a Fuel Pressure and Flow Tester with the Addition of Flow Meter Upgrade Kit MVA5553



Mityvac™

Fuel System Tester

SKU 988886 MITMV5545 **659⁹⁹**

- Measures Fuel System Pressure and Flow to Accurately Pinpoint Fuel System Failures
- Saves Hours of Troubleshooting Time By Diagnosing a Bad Fuel Pump and Other Related Drive Ability Problems in Seconds
- Patented System Simulates Extreme Driving Conditions in the Shop to Provide the Most Accurate Diagnosis
- Capable of Testing Both Return and Returnless Fuel Systems Including Electronic Control
- Provides Clear Visualization of Fuel to Detect Impurities and Air Bubbles



Mityvac™

Diagnose and Pinpoint Common Fuel System Failures Including: Failing Fuel Pump, Faulty Pressure Regulator, Blocked Filter(s), Pinched Fuel Line, Contaminated Fuel and Fuel Tank Vortex.

Compression Testers

Professional Compression Test Kit

SKU 972276 MITMV5530 **89⁹⁹**

Everything You Need to Perform Cylinder Compression Tests on Motorcycles, Marine and Small Engines, and an Air-Hold Adapter for Performing Valve Seal Repairs

- Adapters Include: 10, 12, 14 and 18 mm
- Extended Hoses for Hard-to-Reach Cylinders
- Large 2-3/4" Easy-to-Read Gauge
- Quick Disconnect Fittings



Mityvac™

Master Compression Test Kit

SKU 347236 27266 **119⁹⁹**

- Includes: 2-1/2" 0 - 300 PSI Gauge with 10" Hose, Quick Connect and Protective Boot, Plus 1-1/2" 0 - 200 PSI Gauge for Small Engines
- 2 Separate M14 Hoses (Short Thread and Long Thread); M18 Hose; M10, M12 and M18 Solid Adapters
- Extra O-Rings and Valve Cores Included
- Comes in a Blow Mold Case



OEM TOOLS™

Digital Gas Engine Compression Test Kit

SKU 383182 MITMV5532 **169⁹⁹**

- Stores Maximum Compression Value for Up to 12 Cylinders
- 3 Minute Auto Shut-Off
- Sealed, Grease and Oil-Resistant Gauge Face Prevents Contamination of Electronics
- Displays Values in PSI, Bar and kPa



Mityvac™

Digital Diesel Compression Test Kit

SKU 988885 MITMV5535 **279⁹⁹**

- Features an Electronic Tester That Memorizes Peak Values for Each Cylinder
- Injector Adapter: Dodge 24V 5.9L Cummins (1999-2003); Dodge 5.9L Cummins ISB and ISBE; Case/ Cummins Series "B" 2.9L, 3.9L, 5.9L (Through 1998)
- Glow Plug Adapters: GM 4.3L, 5.7L (1978-1985); Navistar 6.9L, 7.3L (Through 1994); GM 6.2L, 6.5L V8; Ford/Navistar 7.3L Power Stroke (1994-2003); Volkswagen 1.9L TDI
- Right-Angle Adapter



Mityvac™

Mityvac™

Diesel Glow Plug Adapter

SKU 420348 MITMVA5611 **64⁹⁹**

- Applications include: GM Duramax 6600, Isuzu 6.6L
- Glow Plug Adapter - M10 x 1.0



Mityvac™

Ford 6 Liter Adapter

SKU 972279 MITMVA5610 **29⁹⁹**

- Glow Plug Adapter M14 x 1.25
- International VT365
- Ford Power Stroke, 6.0 Liter Engine



Labscope

Dual Channel Labscope

SKU 094926 UEIADL7103 **1,399⁹⁹**

Combines a Two-Channel Digital Storage Oscilloscope, Graphing Multimeter and OBDII Code Reader in One Convenient Instrument.

- Digital Storage Oscilloscope
- Graphing Multimeter OBDII Code Reader
- Sample Rate 25 Meg per Second
- 51 Preset Waveforms That Include Sensor, Actuator, Electrical and Ignition Patterns
- DC to 5Mhz Bandwidth
- Secondary Ignition Displays the Waveform and Includes Spark Voltage, RPM, Burn Time and Burn Voltage
- Parade Pattern on Secondary Ignition "Parade" Mode
- Built-in "Help" Includes Test Procedure
- Includes USB Software to Capture Screen Images



UEI

Glow Plug Reader

Glow Plug Reader

SKU 531174 CDOGPR **199⁹⁹**

- Uses a Resistance Test with Diagnostic Algorithms to Provide an Accurate Diagnostic Result
- No Voltage Applied, Preventing Damage to Expensive Components
- Tests All Plugs Up to 24V On or Off the Car
- Results with Actual Condition Displayed on Backlit Digital Display
- Built-in LED Flashlight for Testing in Low Light Conditions



CanDo INTERNATIONAL, INC.

877-AZTOOL1 / 877-298-6651

Hablamos Español

AZtool1.com



FREE OVERNIGHT SHIPPING
WITH MOST ORDERS
SEE PAGE 3 FOR DETAILS



LAUNCH TECH USA
CREATE · CHANGE

Gear Scan 599.99
SKU 937282 301050380
ALL SYSTEMS HEALTH CHECK REPORT AND SERVICE RESET TOOL

- Scan all Modules in Domestic, Asia, European and Exotics
- Print and Email Pre and Post Health Check Report

GOOD

X-431 PRO 1,395.99
SKU 427081 301190189
FULL SYSTEM, BI-DIRECTIONAL SCAN TOOL AT A NEW LOW PRICE

- 8" Bi-directional Professional Scan tool
- Big Software, Small Price, Great Capabilities

BETTER

X-431 Torque 2,196.99
SKU 939175 301190338
EXPERIENCE THE EASE, FEEL THE POWER

- New Interface, Full Function and Fast
- Open Android with Play Store to Download Apps

BEST

X-431 PAD II AE 3,195.99
SKU 907798 301180411
DROP-TESTED ANDROID™ BASED SCAN TOOL TABLET

- Professional Bi-directional Scan Tool
- Water Proof, Dust Proof and Shock Resistant

MASTER TECH

INNOVA
EXPERT DIAGNOSTICS

PROFESSIONAL DIAGNOSTIC TOOLS

AutoZone SKU#757096
5023 CarScan® Code Reader 79.99
AutoZone SKU#757037
5160 CarScan® Pro 379.99
AutoZone SKU#757067
5100 CarScan® ABS/SRS 249.99



NEW FEATURES FOR 5160

- Bi-Directional / Active Tests
- Steering Angle Reset
- Vehicle Network Scan
- Electronic Parking Brake Assist

INNOVA® CODE READER 3020 49.99
SKU#273349

- All-in-one display provides 20 pieces of vital information on one screen
- Colored LEDs indicate emissions test readiness
- Read & Erase CEL and Domestic vehicle ABS codes



INNOVA® SCAN TOOL 3040 89.99
SKU#273341

- View & Graph Live Data
- Freeze Frame Data
- Read & Erase CEL and Domestic vehicle ABS codes



INNOVA® CODE READER 3100 119.99
SKU#987694

- Enhanced engine and transmission codes
- OBD2 cable includes built in LEDs to easily find data link connector
- Read & Erase CEL and Domestic/Asian vehicle ABS/SRS codes



INNOVA® SCAN TOOL 3160 239.99
SKU#237646

- Oil Light Reset
- Battery Reset & Initialization
- FixAssist- Provides troubleshooting tips and fixes immediately on screen
- Read & Erase CEL and Domestic/Asian/European vehicle ABS/SRS codes



INNOVA® AUTO RANGING DIGITAL MULTIMETER 3320 24.99
SKU#64472

- Auto-Ranging™ scales eliminate the need to dial in the correct range
- Color-coded LED's display battery status quick check
- Protective rubber corner guards for drop protection



INNOVA® AUTOMOTIVE DIGITAL MULTIMETER 3340 99.99
SKU#94874

- Tests alternator diodes, duty cycle, solenoids, breaker points, wiring, switches and more
- 10 MegOhm impedance prevents damage to ECU
- Temperature probe, inductive RPM clamp and carrying case included



INNOVA® SMART TEST LIGHT 3420 17.99
SKU#186535

- Unique transparent handle shows colored LEDs to identify proper connection to source, voltage and ground
- 6-foot leads provide long reach connection

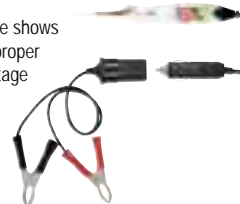

INNOVA® PRO DIGITAL TIMING LIGHT 5568 149.99
SKU#108154

- Four-function digital readout and easy-to-read backlit LCD
- Tachometer - Advance degrees
- Dwell - Voltage
- Switches from 2 to 4 cycle
- Heavy Duty ABS/Polycarbonate shockproof housing
- Patented skip circuitry test



FOR DETAILED COVERAGE VISIT PRO.INNOVA.COM/COVERAGE

FEATURES & BENEFITS	5023	5160	5100
Reads and Clears Check Engine Light	✓	✓	✓
I/M Readiness LED Indicator	✓	✓	✓
Bluetooth Connection/Mobile App		✓	✓
Reads & Clears ABS Trouble Codes		DAE	DAE
Reads & Clears Airbag (SRS) Trouble Codes		DAE	DAE
Powertrain, ABS & SRS Live Data - Stream & Record		✓	✓
Live Data Graphing - 2 or 4 Values		1	2
Oil Light Reset		✓	✓
Battery Reset & Initialization		✓	✓
Network Scan		✓	✓
Trip Cycle Procedure		✓	✓
Steering Angle Reset		✓	
Bi-Directional/Active Test - Over 250 Tests		✓	
Electronic Parking Brake Assist		D	
OBD1 Coverage	OPTIONAL	OPTIONAL	OPTIONAL
RepairSolutions® Pro - Free Trial	1 MONTH	1 YEAR	6 MONTHS

HEAVY DUTY

HD Diagnostics

AL529HD Heavy Duty Code Reader

SKU 868468
AULAL529HD **199⁹⁹**

- Easy-to-Use Handheld Tool to Read and Erase Codes on Heavy Duty Vehicles
- Supports J1939 and J1708 Heavy Duty Communication Protocols
- One-Press I/M Readiness (Emissions) Key
- Code Breaker for Detailed Repair Help
- Auto Vin for Manufacturer-Specific Codes
- Free Lifetime Updates



AUTEL
AUTOMOTIVE INTELLIGENCE

Full Color Heavy Duty Truck Code Scanner with Caterpillar Coverage and OBDII

SKU 344832
CDOHDCODEII **449⁹⁹**

- Extensive Class 4-8 HD, Medium & Light Duty Truck and Caterpillar Coverage
- Includes CAT Power Equipment, CAT Construction and CAT Industrial, International, Hino, Isuzu & Hybrid HD Trucks plus OBDII Vehicles
- Access Engine, Transmission & Brakes
- Read/Clear Codes
- DPF Reset & Regeneration for Fuso, Cummins and Detroit
- View/Graph Live Data
- Easy Updates Via Web
- Coverage for J1939/J1708 and OBDII Protocols



CanDo
INTERNATIONAL, INC.

Extensive Class 4-8 HD, Medium and Light Duty Truck and Caterpillar Coverage

Heavy Duty MaxiSYS[®] Diagnostic Tablet

SKU 596888
AULMS908CV **3,794⁹⁹**

- Performs Enhanced System Diagnostics on More Than 60 Commercial Vehicles
- 9.7" LED Capacitive Touch Screen, Android-Based Tablet
- MaxiFlash Elite, Bluetooth-enabled VCI/J2534 Device
- WiFi and Bluetooth-enabled Tablet
- Read and Clear Codes, View and Graph Live Data
- Perform Tool-Guided Maintenance Services
- Diagnoses Manufacturer-Specific Systems Including Allison Transmissions, Bendix ABS Brake Systems, and Detroit Diesel Engines
- One-Year Software Updates



AUTEL
AUTOMOTIVE INTELLIGENCE

HD Mobile

SKU 868469
CDOHDMOBILE **499⁹⁹**

- Works with iOS and Android
- Class 4-8 Coverage
- Live Data
- Read & Clear Codes
- DPF Resets and Regens for Cummins, Detroit, Fuso and Volvo
- Includes: 6, 9, 16-pin, CAT Connectors, and Free Updates



CanDo
INTERNATIONAL, INC.

Mobile Devices
Not Included

DLA+ 2.0 Adapter Kit

SKU OUTSIDE BUY/EPO
NRS122061 **669⁹⁹**

- Includes: DLA+ 2.0 Adapter
- 9-Pin and 6-Pin Cables
- Type-B OBDII Cables (Ford, GM, Sprinter/Hino/Isuzu, Mack & Volvo)
- USB Computer Cable
- Adapter Kit Carry Case



NOREGON
VEHICLE DATA EXPERTS

Available via Outside Buy/EPO,
Call 1-877-298-6651 for Ordering Instructions

MLT PRO Light to Medium Duty Truck Scan Tool

SKU 201993
CDOMLTPRO **1,499⁹⁹**

- Coverage for Power Stroke, Duramax, Dodge Cummins, Hino, Isuzu, UD and All Types of Sprinter Vans
- DPF Aftertreatment Leak Test & Reset Functions
- One Easy-to-Use Interface for All Manufacturers and Systems
- True IP65 Drop Test and Water Resistant Rating
- Coverage for J1939/J1708 and OBDII Protocols
- OBDII Generic: Read/Clear Codes and Live Data Stream with Graphing
- Includes 2 Years of Updates



CanDo
INTERNATIONAL, INC.

HD Pro II

SKU 597204
CDOHDPROII **3,699⁹⁹**

- Read and Clear Codes, View Live Data Stream, Read System ID and Info, Activation Tests and More
- Extensive HD Coverage Including Class 4-8 Trucks and Industrial Equipment
- Powerful Special Functions: OEM-level Regenerations, Cylinder Cutout, Injector Programming, DPF Activation, Regeneration and Reset, Reset Parameters, DPF/NOX Reset, SCR/DEF Coverage, Service Resets and More
- Diesel Hybrid Access
- 8" TFT Touch Screen Color Display
- Includes 2 Years of Updates



CanDo
INTERNATIONAL, INC.

HD Pro II / Pro Tab Software Update

SKU 082238
CDOHDPROSW **999⁹⁹**

Trailer Diagnostic Adapter Kit w/Power Cable

SKU OUTSIDE BUY/EPO
NRS122511 **679⁹⁹**

- Required to Test, Diagnose, and Initiate Repair on a Heavy Duty Trailer ABS
- Allows Connection Directly to Trailer Using Secondary Power Source
- Includes: Noregon Trailer Diagnostic Adapter, 7-Pin J560 T-Connector Cable, 15' USB Computer Cable, Adapter Carrying Case, J-560 Power Supply



NOREGON
VEHICLE DATA EXPERTS

Available via Outside Buy/EPO,
Call 1-877-298-6651 for Ordering Instructions

HD Pro Tab

SKU 757077
CDOHDPROTAB **5,999⁹⁹**

- IP65 Rating, Drop-Tested and Water Resistant
- Bluetooth Capability
- Open Android Operating System
- Easy-to-Use Interface for All Manufacturers and Systems
- Powerful 1.8GHz Quadcore Processor
- Includes: Multiple Connectors, Docking Station and 2 Years of Free Software



JPRO[®] Professional Diagnostic Software & Adapter Kit with NextStep[™]

SKU OUTSIDE BUY/EPO
NRS232125-NS **3,229⁹⁹**

- JPRO Professional Diagnostic Software (Annual Subscription)
- NextStep[™] Service & Repair Information
- DLA+ 2.0 Adapter
- 9-Pin and 6-Pin Cables
- Type-B OBDII Cables (Ford, GM, Sprinter/Hino/Isuzu, Mack & Volvo)

Connects Heavy Duty Vehicles to a PC via USB Port for Diagnostics, Reprogramming or Parameter Adjustment

JPRO[®] Professional Diagnostic Software and Adapter Kit

SKU 938033
NRS232125 **2,089⁹⁹**

Available via Outside Buy/EPO, Call 1-877-298-6651 for Ordering Instructions



NOREGON
VEHICLE DATA EXPERTS

JPRO[®] Professional Diagnostic Toolbox with NextStep[™]

SKU 938032
NRS263025-NS **4,849⁹⁹**

- JPRO Professional Diagnostic Software (Annual Subscription)
- NextStep[™] Service & Repair Information (Annual Subscription)
- Panasonic Semi-Rugged Toughbook
- DLA+ 2.0 Adapter
- 9-Pin and 6-Pin Cables
- Type-B OBDII Cables (Ford, GM, Sprinter/Hino/Isuzu, Mack & Volvo)
- USB Cable



NOREGON
VEHICLE DATA EXPERTS

Heavy Duty Diagnostics

Navigator TXTs HD Diagnostic System

SKU 767357
 TEXTXHDTBKTAB **6,499⁹⁹**

- Turn-Key Set Up, No Registration Required
- Coverage for All Major HD Engine Manufacturers
- Fast Multi-System Scan with DTC Report and Broadcast DTC Clearing Capability
- Data Graphing
- Advanced Programming Functions
- Integrated Wiring Diagrams and Component Locator
- With I-Support

Off-Highway Basic Kit with AXONE

SKU 908268
 TEXTXOHWBKAX **6,954⁹⁹**

- Off-Highway Diesel Coverage for Agriculture, Construction, and Industrial Engines
- Advanced Activations and Settings Coverage
- Integrated Scalable and Printable Wiring Diagrams
- Durable Design Features Gorilla Glass and IP67 Water-Resistance Rating
- 256GB Solid State Drive
- Includes 1 Year of Updates, Technical Bulletins and DTC Repair Help
- Diagnostic Cables Not Included

HD Truck Package with AXONE

SKU 908271
 TEXTXHDTBKAX **7,694⁹⁹**

- Comprehensive Vehicle Coverage—from Light Diesel Pickups to Class 8 Vehicles
- Subsystem Coverage Including ABS/EBS, Trailer ABS/EBS, Automatic Transmission, Central Gateway, Body Controller, Sonar Systems, Suspension Systems, and Many More
- Quad Core Processor with 8GB RAM
- 256GB Solid State Drive
- Durable Design Features Gorilla Glass and IP67 Water-Resistance Rating
- Includes 1 Year of Updates, Technical Bulletins and DTC Repair Help

TEXA

Off Highway Cables with Case

SKU 938034
 TEXTS049C5 **1,619⁹⁹**



We Offer A Full Line of TEXA Products

AC Hydraulic™

WTA500 Hydraulic Wheel Trolley

SKU 762501
 ACHWTA500 **1,299⁹⁹**

- 1,100 Lbs. Capacity
- Flexible Wheel Trolley for the Removal of Wheels and Brake Drums
- Adjustable Lifting Arms for Wheel Sizes: 10.63" - 51.18"
- Lifting Arms with Roller Bearings Allow Easy Wheel Rotation into Correct Position
- Pedal Operated Pump for Hands-Free Use
- Safety Bracket Secures Wheel for Transport
- Hand-Operated Dead-Man's Control for Optimal Safety
- (2) 360° Swivel Wheels



10 YEAR
 3 YEAR UNLIMITED WARRANTY

AC Hydraulic ^{AS}
 NO COMPROMISE

25-2 Air-Hydraulic 11 Ton Jack

SKU 804467
 ACH25-2 **1,799⁹⁹** REG. 1,999.99

- Minimum Height: 7.20"
- Designed for Heavy Duty, Intensive Commercial Use
- Hard Chromium Plated Piston Rod for Long Life
- Built-in Safety Overload Valve
- Hand-Operated Dead-Man's Control for Optimal Safety
- 2 Extensions (1.97"/3.94")
- Max Height: 14.84"



10 YEAR
 3 YEAR UNLIMITED WARRANTY

Offer Good Through March 31, 2019 While Supplies Last

Lifting Equipment

CWL-10 10 Ton Wheel Lift Pair

SKU 161271
 MSS4858008900 **6,399⁹⁹**

- Lift Entire Vehicle with Patented Wireless Controls and Shop Air
- Perfect for Shops with Low Ceiling Heights
- Built-in Vehicle Support Stand Feature Allows Complete Open Access Under the Vehicle
- Small Wheel Adapters
- Dual Trigger Control Valve Allows Synchronized Raising and Lowering of Vehicle
- Easily Handles Wheel Sizes from 16" to 24.5" with Included Small Wheel Adapters



CCL-300 300LB Clutch Jack

SKU 752063
 MSS4858004400 **1,559⁹⁹**

- 360° Rotating Head Allowing Flexibility During Installation and Removal of Clutches
- Fold Back Feature Allows Technicians to Easily Remove the Jack
- 300 Lbs. Lifting Capacity
- Minimum Start Height 15" (38 cm)
- Maximum Lift Height 39" (99 cm)



MAHLE

Scorpion Jacks™

TJ12S 24,000 Lbs. Capacity Service Jack

SKU 765477
 SPNTJ12S **3,199⁹⁹**

- 7.5" Collapsed Height
- 14x More Support Area Than a Bottle Jack
- Air/Hydraulic Design, No Hand Pumping Required
- Lifts Over 19" with a Built-in 3 Stage Safety Lock
- Full Floating Casters for Easy Maneuvering
- Small Foot Print



TJ14 14-Ton Service Jack

SKU 765528
 SPNTJ14 **4,299⁹⁹**

Lifts

27,000 Lbs. Standard Length Lift

SKU OUTSIDE BUY/EPO
 BENHDS27 **14,719⁹⁹**

- Runways Include Rail-Kit for Optional Accessories
- Runways Adjust for Different Tread Widths
- Electric / Hydraulic Power System
- Fully Enclosed Lifting Cables, Safety Locks, and Sheaves
- Pneumatic Push-Button Safety Release
- Length: 297"

Extended Length Lift

SKU OUTSIDE BUY/EPO
 BENHDS27X **16,189⁹⁹**

- Extended Capacity Lift Features 323" Length Runways

30,000 Lbs. Lift

- Heavy Duty Steel Sheaves and Cables
- 71.75" Rise Height
- Heavy Duty Cylinder
- Single Point Air Actuated Lock Release
- Multiple Locking Positions
- Durable Non-Skid Louvered Approach Ramps

SKU OUTSIDE BUY/EPO
 CHL4030SFX **16,519⁹⁹**

SKU OUTSIDE BUY/EPO
 CHL4030SAX **19,379⁹⁹**

- Turntables Not Included



Available via Outside Buy/EPO, Call 1-877-298-6651 for Ordering Instructions Price does not include vehicles, installation or optional equipment as shown

Challenger Lifts



Available via Outside Buy/EPO, Call 1-877-298-6651 for Ordering Instructions Price does not include installation or optional equipment as shown

HEAVY DUTY

Wheel Balancers



Super-Duty Truck Wheel Balancer with Drive-Check™

SKU 255750
RANRB24T **7,889⁹⁹**

- Shaft Size 40 mm.
- Maximum Tire Diameter 50", Max Tire Weight 400 Lbs., Max. Wheel Diameter 30", Wheel Width Capacity 2" - 20"
- Includes: Centering Cones Included 5 Standard Cones / 1 Dual Tapered Cone, Wheel Calipers
- Voltage 208-240V 50/60HZ 1Ph.



Lift Gate Service

SKU 262533
RANLIFTGATE **95⁰⁰**

WARRANTY: 1 Year Parts and 1 Year Labor

User Setup Required,
Price does not include tires or rims as shown

C206 Portable Hand Spin Wheel Balancer



SKU 543153
CMBC206 **6,789⁹⁹**

- Portable Wheel Balancer with Automatic Distance and Diameter Entry (2D)
- Dual Voltage Power Supply 12VDC - 110VAC
- Easy Hand Spin System Requires Minimum Effort for Spinning
- Manual Lifting System Can Easily Handle Wheel Up to 550 Lbs. (250 Kg)
- Split Program and Optimization Program
- Wheels for Easy Portability
- Battery Pack for Use When Power is Not Available



Lift Gate Service

SKU 765535
CMBLIFTGATE **60⁰⁰**

Price does not include tires or rims as shown

geodyna® 980L Truck Wheel Balancer



SKU OUTSIDE BUY/EPO
HOFEEWB710BW **11,049⁹⁹**

- Motor: 1 HP, 115VAC
- Pneumatic Wheel Lift Aids in Proper Wheel Mounting and Eliminates Need to Manually Lift Heavy Tires
- Operator Can Recalibrate the Balancer in Two Easy Steps, Ensuring Accuracy and Saving Costly Service Calls
- Semi-Automatic Parameter Entry
- Maximum Wheel Assembly Width: 25"
- Rim Diameter: 8" x 30"
- Maximum Wheel Weight: 500 Lbs.
- Includes Automotive Cones



Lift Gate Service

SKU 290017
HOFLIFTGATE **95⁰⁰**

WARRANTY: 1 Year Parts and 6 Months Labor

Available via Outside Buy/EPO, Call 1-877-298-6651 for Ordering Instructions
Price does not include tires or rims as shown

Tire Changers



Super-Duty Truck Tire Changer

SKU 544552
RANR26FLT **6,319⁹⁹**

- Portable Control Unit
- Self-Centering Hydraulic Clamping Chuck
- Spreader Jaws
- Max Rim Diameter: 14" - 26"
- Max Tire Diameter: 63"
- Max Tire Width: 31-1/2"



Lift Gate Service

SKU 262533
RANLIFTGATE **95⁰⁰**

WARRANTY: 1 Year Parts and 1 Year Labor

User Setup Required

CM27T Universal Tire Changer for Trucks and Bus Wheels



SKU OUTSIDE BUY/EPO
CMBCM27T **13,999⁹⁹**

- Clamping Range: 13" - 27"
- Mobile Control Unit
- Bi-Directional Rotation
- Self-Centering Universal Wheel Chuck



Lift Gate Service

SKU 765535
CMBLIFTGATE **60⁰⁰**

Available via Outside Buy/EPO,
Call 1-877-298-6651 for Ordering Instructions
Price does not include tires or rims as shown

Smoke Leak Detectors

Air Brake NanoLeak Finder™

SKU 743984
RED95-0121A **3,599⁹⁹**

- Professional Grade Equipment Comes with All Accessories Needed
- Runs on Compressed Air and 12V DC
- Weighs Only 18 Lbs.
- Utilizes Test Pressure Up to 9.3 Bar (135 PSI)



PowerSmoke Pro™ Leak Detector



SKU 743985
RED95-0170 **3,299⁹⁹**

- Specifically for Light to Medium Duty Vehicles with Forced Induction Engines
- Variable Pressure Variable Flow
- 40X Typical EVAP Pressure
- Compact, Rugged Design
- Professional Grade Strong
- Made with Steel and Billet Aluminum
- Not for Use on EVAP
- Runs on Compressed Air
- Powered By 110-250V AC or 12V DC
- 2-20+ PSI Range



3.9" Intake Bladder

SKU OUTSIDE BUY/EPO
RED95-0083 **389⁹⁹**

- Expandable Bladder Seals Off Intake and/or Exhaust During Diagnostic Tests on Heavy Duty, Class 7 & 8 Vehicles.



Available via Outside Buy/EPO, Call 1-877-298-6651 for Ordering Instructions

A/C Recovery Machines



R134a Handling System for Heavy Duty A/C Servicing

SKU 19239
MSSACX1180C **5,039⁹⁹**

- Fully-Automatic Program to Recover, Vacuum, Leak Test and Charge
- 50 Lbs. Internal Tank
- 5 CFM 2-Stage Vacuum Pump
- Integral Paper Printer and Print to USB
- Hybrid Certified

2 Year Warranty, Parts & Labor

Set-Up and Training Available Upon Request



Alignment Diagnostic



Fleet Glove Handheld Laser Tire and Alignment Tool

SKU 751989
TPIGG003 **4,699⁹⁹**

- Captures All Necessary Data for Tire Alignment, Tread Depth, and Rotation Diagnostics
- Touch Screen Allows Easy Data Capture from Tire to Tire
- Built-in Inertial Sensor Software Makes Scanning Tires Fail-Safe
- No Space Requirements for Performing an Alignment Diagnosis

Specialty Tools

Heavy Duty U-Joint Puller

SKU 041474
24538 **149⁹⁹**

- Easily Removes Seized U-Joint Cups on Most Class 7 and 8 Trucks
- Safely Disassemble Driveshafts without Hammering or Heating Components
- Does Not Damage the Driveshaft, Yokes, Joints or Bearing Cups



NAVISTAR® MAXXFORCE® Fuel Line Disconnect Tool Set - 4 Piece

SKU 004112
25031 **34⁹⁹**

- 4 Piece Disconnect Tool Set for Navistar® MaxxForce® Series 11 and 13 Engines
- Sized to Depress Fuel Release Tabs for Efficient Fuel Line Removal
- (1) Straight and (1) 90° Tool for 11.8mm Fuel Lines;
(1) Straight and (1) 90° Tool for 16 mm Fuel Lines



DID YOU KNOW?

AutoZone® has multiple financing options for large tool or equipment purchases to include Leasing and/or interest free Extended Payment options.

Contact Your AutoZone Commercial Sales Manager for Details

877-AZTOOL1 / 877-298-6651

Hablamos Español

AZtool1.com



FREE OVERNIGHT SHIPPING
WITH MOST ORDERS
SEE PAGE 3 FOR DETAILS

The fastest growing all-makes program for today's heavy duty applications



Aftertreatment &
Engine Sensors



EGR Valves & Coolers



Engine, Suspension & More



Fluid Reservoirs
(Caps & Sensors)

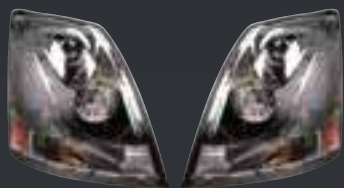

Headlights & Lighting



Switches (All Types)



Exterior & Interior Cab Parts



Exterior Crash Parts

NEW! HEAVY DUTY
VIN SEARCH

VIN - Powered by OmniVIN

DormanHDSolutions.com

**YOU ONLY DO THINGS ONE WAY
THE RIGHT WAY
YOU'RE ALL ABOUT THE FIX.**



SO ARE WE.

Engineered Solutions
Designed to Address Known
OE Failure Modes

For even more examples of
Dorman OE FIX solutions,
visit DormanProducts.com/OEFIX



Heater Hose Assembly
626-315HP

OE PROBLEM:

Original Y-connectors are made of plastic
and frequently crack and leak.



Dorman upgraded the Y-connector material to aluminum for
increased durability and a longer service life.

FAILED UNIT



NEW FIX



Electronic Throttle Body
977-025

OE PROBLEM:

Original unit frequently requires
replacement due to electronic sensor
failure and excessive wear and tear.



Dorman's Electronic Throttle Body Assembly is completely
redesigned with a new electronic board that includes a hall effect
sensor for a longer and reliable service life.



BATTERY SERVICE

SAVE \$10 ON KS400 KWIKSTART® JUMP STARTER - ASCKS400G



Commercial Grade 18000 mAh Li-ion Jump Starter and Power Bank

For Heavy Duty Use

SKU 765536 | 24476

248⁹⁹

- Jump-Starts Trucks, Cars, Boats, ATVs and Other Vehicles
- Charges Phones, Tablets, and Other Personal Electronics
- Powerful, High Capacity Nano Lithium Battery
- 450 Cranking Amps and 900 Peak Amps
- Fast Charging with Up to 1000 Charging Cycles
- IP-65 Water Resistant Housing
- Professional Grade Heavy Duty Clamps with 100% Copper Contacts
- Power Ports: (2) 5V/2A-1A, 12V/10 A, 12V Jumpstart Built-in for Overcharge and Over Discharge Protection
- Dimensions: 8" L x 1.5" H x 3.75" W
- Weight: 1.50 Lbs.

OEM TOOLS™

PPS-X
SMART JUMP CABLES

- Li/18000 mAh
- 900 Peak Amps
- 450 Cranking Amps
- Copper Clamps
- LED Flashlight

Jump Starters

8000 mAh Li-ion Jump Starter and Power Bank

SKU 765509 24474 **69⁹⁹** Reg. 89.99

SAVE \$20

OEM TOOLS™

- Li/8000 mAh
- 200 Cranking Amps

- Jump-Starts Cars, Charges Phones, Tablets and Personal Electronics
- Compact, Portable Power Bank Easily Stores in Glove Box, Center Console or Purse
- 200 Cold Cranking Amps and 400 Peak Amps
- Features Include: 12V Emergency Start, LED Flashlight and USB Charging Port
- Weight: .75 Lbs.
- Replacement Cables

Best Emergency Jump Start Available

Offer Good Through March 31, 2019 While Supplies Last

12000 mAh Li-ion Jump Starter and Power Bank

SKU 765539 24475 **161⁹⁹**

OEM TOOLS™

- Li/12000 mAh
- 300 Cranking Amps

- Jump-Starts Cars, Vans, SUVs and Light-Duty Pickups
- Charges Cell Phones, Tablets and Other Personal Electronics
- 300 Cold Cranking Amps Will Jump-Start Engines (Up to V6)
- Fast Charging with Up to 1,000 Charging Cycles
- Heat Sensors to Protect Against Thermal Runaway
- 100% Copper Clamp Inserts
- Features Include: 12V Emergency Start, LED Flashlight and USB Charging Port
- Replacement Cables

Perfect for the Technician

Jump Starts a V6 Up to 20 Times, 95% Lighter Than Lead Acid Jump Starters

Jump Starters

KS400 KwikStart® Jump Starter

SKU 850635 ASCKS400G **289⁹⁹** REG. \$299.99

SAVE \$10

ASSOCIATED

- Exclusive Heavy Duty 22Ah Sealed AGM Battery Provides Powerful "Best-in-Class" Performance
- Replaceable Field Serviceable Cables and Battery
- Built-in Digital Voltmeter, 12V Power Port and USB Power Port

Offer Good Through March 31, 2019 - While Supplies Last CCA: 360

Kwikstart® 12 Volt Portable Power and Jump Start

SKU 850637 ASC6256 **199⁹⁹**

ASSOCIATED

- Peak Amp Output: 1700 Amps
- USB Port
- (2) 12 Volt DC Accessory Outlets to Power and/or Recharge DC Electronics
- 32" Heavy Duty Cables

CCA: 360

Boost Ultra 1800 Peak Amp Jump Starter

SKU 081209 CAL590 **259⁹⁹**

Cal-Van Tools

- 12V Vehicle Jump Starter and Back-Up Charger for Portable Electronics
- 800 Cranking Amps and 1800 Peak Amps
- 30,000 mAh High Capacity Li-Ion Battery with Fast Charging with Low Self-Discharge Cycle
- Includes Intelli-Clamps for Jumpstarting with Built-in Safety and Diagnostic Features

Smart Chargers

6/12V, 12/2/50A Fully Automatic

SKU 850633 ASC3055A **114⁹⁹**

- LED Display Indicates Charge Current, % Charged
- Charges AGM/GEL/SLA and Deep Cycle Battery Types
- 50 Amp Engine Start Feature for 12V Application

6/12V, 12/2/75A Fully Automatic

SKU 850632 ASC3075A **134⁹⁹**

- Charges AGM/GEL/SLA and Deep Cycle Battery Types
- 75 Amp Engine Start Feature for 12V Application
- Automatic Bad Battery Detection

It is important to use Smart Chargers when charging AGM Batteries. Standard Battery Chargers will not fully charge AGM Batteries and can shorten their life.

ASSOCIATED

6/12V, 15/2/100A Fully Automatic

SKU 850634 ASC3100A **129⁹⁹**

- Charges AGM/GEL/SLA and Deep Cycle Battery Types
- 100 Amp Engine Start Feature for 12V Application
- Automatic Bad Battery Detection

Maintainers

Underhood 12V 1.5A Automatic Charger/Maintainer

SKU 765553 ASC9002A **49⁹⁹**

- Automatically Powers on When Needed
- LED Charging Light Indicates Charging Status
- Reverse Polarity and Short Circuit Protection
- Designed to Be Mounted in Proximity of Battery
- Safe for All 12V Lead Acid Battery Types - Conventional, AGM and Gel Cell

ATEC 9003A Automatic 6/12V Battery Charger/Maintainer

SKU 765478 ASC9003A **54⁹⁹**

ASSOCIATED

- OEM Vehicle Manufacture Approved
- Safe for All Battery Types
- CEC California Compliant
- Will Never Overcharge a Battery

Battery Chargers

Fast Charger Cranking Assist

SKU 344795 ASCUS20 **349⁹⁹**

- 40 Amp Continuous Rating at 6/12 Volts
- Manufacturer's Boost Rating 330 Amps
- 90 Minute Timer with Hold
- Fan Cooling Mechanism Prevents Overheating

Professional Fast Charger Cranking Assist

SKU 496661 ASC6012 **549⁹⁹**

- 6/12 Volt, 70/60 Amp Output
- 250 Amp Crank Assist
- Fan Cooling Mechanism Prevents Overheating

6/12/24-Volt Heavy Duty Fast Charger

SKU 444366 ASC6006 **599⁹⁹**

- 12 Volt, 70 Amp Output
- 250 Amp Crank Assist
- UL Rated Safe in Any Weather, Indoor/Outdoor Approved
- Made in USA, 5 Year Limited Warranty

60 Amp/270 Amp Intellamatic Boost Wheel Battery Charger and Power Supply

SKU 344790 ASCESS6008 **699⁹⁹**

ASSOCIATED

- DC Output 60 Amps/70 Amps in Power Supply Mode
- DC Leads 6-1/2" 6.5 AWG
- Clamp Rating 400A
- Limited Warranty Three Years
- Shipping Dimensions 23" x 19" x 16"
- Weight 49 Lbs.
- AC Cord / Voltage 6' 16-3 / 120VAC 60 Hz
- Battery Types 12 Volt Flooded, AGM, and Gel Cell Batteries - Including Spiral Cell, Orbital, or Optima Batteries

12Volt, 45A Intellamatic Pro Wheel Charger

SKU 343370 ASCESS6007B **599⁹⁹**

- Charges All Types of 12V Batteries
- Dead Battery Override Control
- All Weather Safe
- Made in USA

6/12-Volt Commercial Charger

SKU 496657 ASC6001A **749⁹⁹**

- 6/12 Volt, 100/75 Amp Output
- 375 Amp Crank Assist
- UL Rated Safe in Any Weather
- Made in USA
- 5 Year Limited Warranty

6/12/18/24-Volt Commercial Charger

SKU 221248 ASC6002B **919⁹⁹**

- 6/12/24 Volt, 100/80/50/40 Amp Output
- 400 Amp Crank Assist
- UL Rated Safe in Any Weather, Indoor / Outdoor Approved
- Made in USA, 5 Year Limited Warranty

Intellamatic Pro Series Electrical Stability Technology

ASSOCIATED

FAST, RELIABLE RESULTS WITH TRUE LOAD TESTING!

USE OUR TRUE LOAD TESTERS TO SELL MORE BATTERIES

THESE FOUR HAND HELD TESTERS FOR AUTOMOTIVE AND SPECIALTY APPLICATIONS INCORPORATE A STATE-OF-THE-ART MICRO-PROCESSOR, AND AUTO METER'S PATENTED ADVANCED DIGITAL PULSE LOAD TECHNOLOGY FOR TRUE-LOAD RESULTS.



Handheld Battery, Alternator & Starter Tester
 SKU 721462 BVA-300 **399.99**

- Tests flooded and AGM batteries
- Accurate testing using Digital Pulse Load Technology
- On-board 40 AMP load
- Performs a complete electrical system test in less than two minutes

Optional printer accessories available

Handheld Battery & Reserve Capacity Tester
 SKU 543339 RC-300 **499.99**

- Tests sealed lead acid, flooded, AGM, and gel cell batteries
- Accurate testing using Digital Pulse Load Technology
- On-board 40 AMP load
- Tests reserve capacity on 4 AH to 50 AH rated batteries

Optional printer accessories available

Handheld Battery Tester
 SKU 721461 SB-300 **357.99**

- Tests flooded, deep cycle, and AGM batteries
- Accurate testing using Digital Pulse Load Technology
- On-board 40 AMP load
- Performs a full battery test in less than two minutes

Optional printer accessories available

Professional Handheld Battery, Alternator & Starter Tester
 SKU 721465 BVA-200s **779.99**

- Tests flooded and AGM batteries
- Accurate testing using Digital Pulse Load Technology
- On-board 120 AMP load
- Performs a complete battery, alternator & starter test

Optional printer accessories available

Battery Testers

Digital Battery Analyzer

SKU 819073 **49.99**
 24359

- Shows available power in CCA's
- Starter and charging system testing
- Easy-to-Read Backlit LCD Screen
- Voltage Range: 1.5-15VDC
- Battery CCA: 200-1200



STORE STOCKED

Battery Tester HH 6 and 12V 135A

SKU 496662 **59.99**
 ASC6026

- Tests Both 6/12 Volt Batteries
- Tests Alternators and Starters
- 300 Amp Vinyl Coated Clamps
- 1-Year Warranty



110 Amp Battery Tester

SKU 434261 **199.99**
 ASC6031

- Semi-Automatic Battery, Starter, Alternator Tester
- Performs State of Health for Conventional and Maintenance Free Batteries
- Built-in Side Terminal Adapters
- Made in USA with 1-Year Warranty



Digital Electrical System Analyzer Tester

SKU 343372 **199.99**
 ASC12-1012

- Lightweight Hand-Held Conductance Digital Battery Tester with USB Port Tests Battery, Starter and Alternator on 12V Systems



Battery Conductance Tester

SKU 291330 **184.99**
 MIDPBT100

- Tests Both the Starter and the Charging System
- Tests 12V Automotive Batteries from 200 - 850 CCAs
- Durable Design for the Workshop or in the Field



Advanced Diagnostic Battery Conductance/Electrical System Tester

SKU 291329 **299.99**
 MIDPBT300

- Tests 12V Automotive Batteries from 100 - 1,400 CCAs
- Voltmeter Mode for Testing Both Starter and Charging Systems
- Accurate Battery Test Decisions in Seconds



6V and 12V Battery and Electrical System Tester for HD/Fleet with Integrated Printer

SKU 291334 **1,019.99**
 MIDMDX700PHD

- Applications: 6V and 12V Batteries and 12V and 24V Charging Systems
- Battery Types: Flooded, AGM, AGM Spiral and Gel
- Vehicle Applications: Group 31, Automotive, Motorcycle, Marine Cranking, Lawn and Garden and Commercial 4D/8D Batteries



Digital System Analyzer Tester w/ Printer

SKU 343373 **329.99**
 ASC12-1015

- Volt Meter 5-91 Volts
- Stores Last Test Series
- 10 Line LCD Display
- Battery, Starter and Alternator Tests
- Carrying Case Included



12V Battery and Electrical System Tester with Built-in Printer

SKU 291331 **539.99**
 MIDMDXP300

- Tests 12V Batteries from 100 to 1400 CCA, Including AGM and Gel
- Integrated Printer Allows Immediate Printing of Test Results



Refractometers

Coolant and Battery Refractometer

SKU 471116 **59.99**
 ROB75240

- Can Be Used for Measuring the Freezing Point of Either Propylene or Ethylene Glycol Based Cooling Systems
- Can Also Be Used for Checking the Strength of Electrolyte Solution Batteries
- This Precision Instrument Features High-Quality Optics with Ultra-Smooth Focusing
- Scale Range: -60° F To 32° F.



Reset Tools

Battery Reset Tool

SKU 572412 **129.99**
 CDOCBATTBMC

- Perform Battery Resets on: BMW/Mini, VW/Audi, Jaguar, Land Rover, Ford and More

Some New Vehicles Require a Scan Tool to Reset the Battery Life in the Vehicle's Computer When Replacing the Battery. Failure to Do So Can Cause Over-Charging, Shorten the Battery Life and/or Enable Limp-Home Mode and Even a No-Start Situation.



Battery Tester and Reset Tool

SKU 942257 **399.99**
 CDOBATTRT

- Battery Test On and Off the Vehicle
- Multiple Testing Modes: Battery Condition, Grounding, Starter and Alternator Condition
- Battery Replacement Relearns: Porsche, BMW, MINI, VW, Volvo, AUDI, Jaguar, Land Rover, Ford, Toyota, Lexus, Mazda
- Free Updates



DID YOU KNOW?

AutoZone® has the Starting Battery for the 2002 - 2013 Toyota Prius

Contact Your AutoZone Commercial Sales Manager for Details

The Multi Service Tool ANYONE can use!

Brake, Oil, Battery, DTC's & more!



OBD 300

- ☑ Relaxes E-Brakes
- ☑ Resets oil Service Light
- ☑ Re-calibrate Battery Installs
- ☑ Check and clear DTC's



BARTEC USA

BATTERY SERVICE



QUICK, EASY BATTERY ANALYSIS

It's never been easier to test a battery and analyze the starting and charging systems of your vehicle. Digital Battery Analyzers from OEMTOOLS™ are safe, fast, and reliable. They check voltage, cold cranking amps (CCA) and resistance, as well as overall battery condition. Clear and easy-to-understand results are displayed on a large backlit LCD screen.

Digital Battery Analyzer

SKU 544740 **59⁹⁹**
24369

- Accurate 12V Battery Test Decision in Seconds
- Shows Available Power in CCA's
- Starter and Charging System Testing
- Easy-to-Read Backlit LCD Screen
- Voltage Range: 1.5-15VDC
- Battery CCA: 40-2000

Digital Battery, Charging System, and Starter Analyzer

SKU 819073 **49⁹⁹**
24359

- Shows Available Power in CCAs
- Starter and Charging System Testing
- Easy-to-Read Backlit LCD Screen
- Voltage Range: 1.5-15VDC
- Battery CCA: 200-1200

START DEAD BATTERIES.™

Jump Start Gas & Diesel Cars, Boats, Motorcycles, Trucks, & More Up To **10L.**

- Rugged UltraSafe® Lithium Jump Starter
- **USB** Battery Pack
- **LED** Flashlight With 7 Modes
- **12V** Power Supply (GB70 & GB150)
- Integrated **Voltmeter** (GB150)

TOOL of the MONTH
JANUARY
SEE INSERT FOR DETAILS

NOCO®

GB20 Boost Sport
12V 400A
678846

GB40 Boost Plus
12V 1000A
824997

GB70 Boost HD
12V 2000A
851787

GB150 Boost Pro
12V 4000A
344821

Battery Testers

NEW Batter/Alternator Tester
 SKU 082958 BT55U **32⁹⁹**

- For testing 6/12/24 volt batteries, up to 1200 cold cranking amps, battery state of charge, charging system output, alternator system
- Accurate, easy-to-read LCD screen
- Two LED indicators
- Overvoltage and Reverse Polarity Protection



NEW Wireless 6V/12V Battery and 12V/24V System Tester
 SKU OUTSIDE BUY/EPO SBT1 **299⁹⁹**

- Perform battery and system tests wirelessly from your smartphone or tablet
- For 6V and 12V automotive batteries (SS EFB and AGM included) and 12V/24V charging/starting systems
- Easy and fast Bluetooth® pairing Works with SBT1 Schulink™ app, which includes eight language settings.
- Performs Battery Test, System Test, Start-Stop Test and EV Battery Test Email or text test results – stores 2,000 test records Test batteries with as little as 1.5V



ProSeries Tester w/ Printer
 SKU 112548 PST-900X **499⁹⁹**

- 3 Tests in 1
- Tests 6V & 12V Batteries
- Tests 12V & 24V Charging Systems
- Works with Standard & AGM Batteries
- Easy to Operate
- Battery | Starting | Charging



Wheel Chargers



Designed for today's professional, these new fully automatic heavy-duty chargers provide generous engine starting power for SUVs, trucks and large engines. They also include Boost mode—for bringing deeply discharged batteries back to life, as well as Charge and Maintain settings.

All models include convenient retractable handles, extra-long cables, digital display, LED indicators, touch pad controls and Start/Stop button. Models DSR122 and DSR124 add Flash Reprogramming and Memory Saver Mode. Designed to charge new technology batteries such as standard, AGM, Gel Cell, Deep-cycle and Stop Start.

Model	Fully Automatic	Charging Voltages	Flash Programming	Charging Rates	Engine Start Rating	Price
DSR131 SKU 390362	Automatic	6V, 12V	—	50/ 2<->6 Amps	125/250 Amps (6/12V)	249⁹⁹
DSR121 SKU 550518	Automatic	12V	—	25<->50/15/4 Amps	250 Amps (12V Only)	617⁹⁹
DSR122 SKU 550041	Automatic	6V,12V	65A	20<->60/15/4 Amps	125 Amps (12V Only)	781⁹⁹
DSR123 SKU 550363	Automatic	12V, 24V	—	10<->50/15/4 Amps	250 Amps 12V 150 Amps 24V	752⁹⁹
DSR124 SKU 550000	Automatic	6V, 12V, 24V	70A/100A	30<->80/15/4 Amps	330/300/250 Amps (12/6/24V)	951⁹⁹

Multi Bank Charger



6V/12V8-Bank Automatic Battery Charging Station
 SKU 550017 DSR127 **1,178⁹⁹**

- Charge up to 8 Batteries at a time
- Works on 6V & 12V Batteries
- Automatically adjusts from 2 to 12A output per bank
- Charges 6V and 12V Standard, AGM, Gel, deep-cycle and LFePO4 batteries
- Eight detachable 6 foot cables with 75 Amp, color-coded clamps
- Separate LED battery status indicator for each bank
- Recovery mode – for sulfated Standard and AGM batteries.
- Start/Stop button
- Schu Eco Energy – meets the highest industry standards



Now you can charge up to eight 6V and 12V batteries simultaneously. This unit is safe and smart with each bank being completely automatic with a microprocessor to prevent overcharging, reverse polarity and short circuits. You can even revive severely discharged 12V batteries with recovery setting. With a digital display to keep you informed, a durable steel case and detachable 6 foot cables, this charger is ready to perform

Bench Chargers



12V | 10A Battery Charger with 13.6V Service Mode
 SKU 550281 DSR117 **90⁹⁹**

- Microprocessor Controlled - Automatically adjusts the amperage rate to charge & maintain. Multi-stage charging for added precision, safety & battery life.
- Compatible Battery Types - Standard, AGM & GEL
- Reverse Hook-up Protection - Charger will not operate if clamps are reversed
- 13.6V Service mode - maintains a stable voltage at 13.6V and prevents discharged batteries during service or sitting idle in a showroom.
- Hook Attachment - Allows unit to hang safely outside the work area

6V/12V Battery Charger with 125A Engine Start
 SKU 550408 DSR118 **176⁹⁹**

- Powerful enough for SUVs, trucks
- 15<->40A Boost Mode – ramps up the voltage and sends a quick burst of energy into the battery quickly bring deeply discharged batteries back to life.
- 15<->40A Service Mode – maintains a stable voltage at 13.6V and prevents discharged batteries during service or sitting idle in a showroom.
- Scrolling Digital Display - The easy-to-read, animated display gives you step by step instructions to properly charge your battery.

Jump Starters/Portable Power



*DSZR116 Includes built-in power-inverter.



Model	Voltage	CA	CCA	High Output Batteries	Price
DSR119 SKU 897167	12V	280	225	1	149⁹⁹
DSR114 SKU 897175	12V	525	350	1	219⁹⁹
DSR115 SKU 883697	12/24V	750/475	525/350	2	549⁹⁹
DSR116* SKU 897170	12V	525	350	1	249⁹⁹
DSR128 SKU OUTSIDE BUY/EPO	12V	650	350	2	349⁹⁹

NEW Heavy Duty Lithium Ion Jump Starter



Lithium Power

NEW JUMP STARTER + FUEL PACK + BACK-UP POWER
 SKU OUTSIDE BUY/EPO SL1338 **99⁹⁹**

- 4 Cylinder Engines
- 400 Peak Amps
- Jump Starter – Quickly starts vehicles in emergencies. Great for power sports, motorcycles and 4 cylinder cars.
- Mobile Power – Fast charging. 2.4A/5V USB port. Charge all USB devices, including smartphones, MP3 players and tablets.
- Safe Smart Clamps – Provide protection against reverse polarity, short circuit, low voltage, high temperature and reverse charging
- LED Battery Indicator – 4 LED battery indicator for easy read battery charge level
- Compact Design – This durable case has a soft-touch finish and portable compact design. It fits conveniently in your travel bag, backpack or glove box
- Power ON/OFF Button
- Built-in LED Light – (3 modes).



NEW JUMP STARTER + FUEL PACK + BACK-UP POWER
 SKU 897172 SL1314 **99⁹⁹**

- V6 Engines
- 600 Peak Amps
- LCD Display with ON/OFF button – easy-to-read display shows battery capacity and input/output.
- Compact Design – This durable case has a soft-touch finish and portable compact design. It fits conveniently in your travel bag, backpack or glove box
- Jump Starter – Quickly starts vehicles in emergencies. Great for power sports motorcycles and for 6 cylinder cars.
- 2.1A +1A USB Ports – 2x faster charging. Charge all USB devices, including smartphones, MP3 players and tablets.
- Smart Cable – Provides protection against reverse polarity, short circuit, low voltage, high temperature and reverse charging.
- Built-in LED Light – (3 modes).



NEW JUMP STARTER + FUEL PACK + BACK-UP POWER
 SKU 082957 SL1327 **127⁹⁹**

- V8 Engines
- 800 Peak Amps
- LCD Display with ON/OFF button – Easy-to-read display shows battery capacity and input/output
- Compact Design – This durable case has a soft-touch finish and portable compact design. It fits conveniently in your travel bag, backpack or glove box
- Jump Starter – Quickly starts vehicles in emergencies. Ideal for 8 cylinder cars.
- Qualcomm® Quick Charge™ Technology – Quick charge technology makes charging mobile devices 4x faster and more efficient than conventional USB. Qualcomm Quick Charge is a product of Qualcomm Technologies, Inc. and/or its subsidiaries.
- 2.1A USB Port – Charge all USB devices, including smartphones, MP3 players and tablets.
- Smart Cable – Provides protection against reverse polarity, short circuit, low voltage, high temperature and reverse charging.
- Built-in LED Light – (3 modes).



SEE ALL OUR POWER TOOLS AND ACCESSORIES PAGES 94-97



A BETTER WAY TO WORK.

- Faster cleanup** — handle the mess and get back to work
- Easy to use** — just put it down, let it work and pick it up
- Grit- and dust-free** — won't damage delicate sensors, parts or drains.
- No tracking around** — helps maintain a clean, professional appearance in the shop

pig Absorbents & Liquid Control
 Leading shops work clean with PIG.
 Manufactured by: New Pig Corporation • Tipton, PA 16684-0394

SKU	PART #	DESCRIPTION
186468	25300	Pig Universal Mat Med. Weight
186469	25100	Pig Universal Mat Lt. Weight
289880	35700	Pig Universal Sock
289882	35306	Absorbent Mat Pads 3Pk.
374621	25801	Pig Grippy Garage Mat
374622	25822	Pig Grippy TLBX Liner
374623	25820	Pig Grippy WRKBN Liner
374624	25821	Pig Grippy TLBX Liner
516794	57702	Adjustable Roll Dispenser
516796	26100	Oil Only Lt. Weight ABS 15x20
516802	26306	Oil Only Med. Weight ABS Mat Pk.
516803	26101	Oil Only Lt. Weight Mat Tablet
516809	25400	Univ. Med. Weight ABS 30x150
516824	45300	Univ. Spill Kit Bag
516829	45301	Univ. Spill Kit 5 Gallon



GET A FREE OIL RACK WITH YOUR INITIAL BOXED OIL ORDER

Organize your shop's inventory! Display and dispense your oil with an all metal rack that can accommodate 6 24-quart boxes of oil. Also includes 3 dispatching oil pitchers.

TO GET YOUR FREE OIL RACK, ORDER*

- 12 boxes of STP Oil (minimum initial order)
- 12 additional boxes of STP Oil (within 1 year of initial order)

Mix & Match

Mix & Match

\$199⁹⁹
VALUE
 OIL NOT INCLUDED



SKU	PART #	DESCRIPTION
562192	SZN5206G	5W-20 STP Conventional (24 Qt.)
562190	SZN5306G	5W-30 STP Conventional (24 Qt.)
562201	SZN3136G	10W-30 STP Conventional (24 Qt.)
562204	SZND026G	0W-20 STP Dexos Synthetic (24 Qt.)
562206	SZND526G	5W-20 STP Dexos Synthetic (24 Qt.)
562203	SZND536G	5W-30 STP Dexos Synthetic (24 Qt.)
569634	SZN6LV6G	STP Multi-Vehicle ATF (24 Qt.)

CALL YOUR COMMERCIAL SALES MANAGER FOR PRICING

* Must have a minimum initial order of twelve (12) boxes of STP oil and a minimum purchase of at least 24 total boxes within the first year (including initial order) to receive a free oil rack. Oil rack will be delivered within 1-2 weeks of initial order. If 24 total boxes of STP oil are not purchased within one (1) year of the initial purchase, the full value of the rack will be billed to your account. Regular price and savings may vary by AutoZone Commercial Store. Offers valid for Commercial customers only. Please allow 1-2 weeks for delivery. We reserve the right to limit quantities. Prices subject to change without notice. Offer not valid with any other offer. © 2018 AutoZone, Inc. All Rights Reserved. AutoZone and AutoZone & Design are registered marks of AutoZone IP LLC. All other marks are property of their respective owners. The STP trademark and logo are trademarks of The Armor All/ STP Products Company and used under license.

FOR FINANCING PROGRAMS SEE PAGE 2

877-AZTool1
877-298-6651
Hablamos Español
AZtool1.com

ALLDATA[®]
AUTOMOTIVE INTELLIGENCESM

NEW TOOLS OF THE TRADE

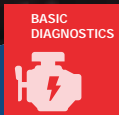

ALLDATA MOBILE[®]

No more back and forth between the vehicle and the computer station. Get all the OEM repair data you need with a subscription to ALLDATA Repair[®] and Mobile. With our mobile app you can read/clear P-Codes, view live sensors, pre-check emissions, and more with an OBDII connector and tablet.

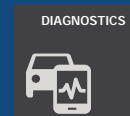

INTRODUCING ALLDATA DIAGNOSTICS[™]

The only scan tool with the power of ALLDATA built in.

- ▶ Next generation technology that turns your Android or Windows 10 tablet into a powerful scan tool.
- ▶ Affordable scan tool alternative – no major upfront equipment costs to get started, just a low monthly subscription.
- ▶ Professional-level functionality: retrieve and clear manufacturer P, B, C, and U codes, read and graphically display PIDs, and more.



ALLDATA TECH-ASSIST[®]

Need help figuring out a complicated repair? Put ALLDATA's Master techs on the case. Staffed by highly-skilled ASE Certified Master Technicians, ready to tackle your toughest automotive challenges. Live video-stream the problem using your smartphone and the free Rescue Lens app.*



* Download the Rescue Lens app prior to calling ALLDATA Tech-Assist.

An AutoZone[®] Company

FOR MORE INFORMATION
(888) 726-3211

©2019 ALLDATA LLC. All rights reserved. ALLDATA, ALLDATA Repair, ALLDATA Mobile and ALLDATA Tech-Assist are registered trademarks and ALLDATA Diagnostics is a mark of ALLDATA LLC. AutoZone and AutoZone & Design are registered trademarks of AutoZone IP LLC or one of its affiliates. ASE Certified is a trademark of the National Institute for Automotive Service Excellence (ASE). All other marks are the property of their respective holders.

BRAKE SERVICE

BUY THIS

Model 4000B Brake Lathe

SKU 534380
AMM904000B **8,639⁹⁹**

- Must Be Purchased with a Bench Lathe Adapter Kit
- Twin Cutter Heads
- Two Spindle Speeds

INCLUDES:
Manufacturer's Set-Up and Training

Lift Gate Service

SKU 262529
AMMLIFTGATE **55⁰⁰**

Negative Rake (10 Pack)

SKU 262386
SHA06210 **29⁹⁹**



AMMCO

WARRANTY: 1 Year Parts and 6 Months Labor

FREE DELIVERY:
In 48 Continental United States

LEASING TERMS AVAILABLE:
Ask Your AutoZone® Commercial Sales Manager

GET A BONUS

With Purchase of
Model 4000B Brake Lathe
SKU 534380 | AMM904000B

GET
Brake Lathe Bench Kit
SKU 212739 | AMM902500
and
Model 6E Lathe Adapter Kit
SKU 496630 | AMM900006

VALUED AT
\$2,659.98

Offer Good Through
March 31, 2019
While Supplies Last



BUY THIS

Model 4000SP Single Pass Brake Lathe

SKU 210247
AMM904000SP **6,699⁹⁹**

- Cut Rotors in One Pass, with a High-Quality Finish
- Single Speed Spindle and Feed Rates
- Requires the Purchase of an Adapter Kit of Your Choice

INCLUDES:
Manufacturer's Set-Up and Training

Lift Gate Service

SKU 262529
AMMLIFTGATE **55⁰⁰**

Negative Rake (10 Pack)

SKU 262386
SHA06210 **29⁹⁹**



AMMCO

WARRANTY: 1 Year Parts and 6 Months Labor

FREE DELIVERY:
In 48 Continental United States

LEASING TERMS AVAILABLE:
Ask Your AutoZone® Commercial Sales Manager

GET A BONUS

With Purchase of
Model 4000SP Single Pass Brake Lathe
SKU 4210247 | AMM904000SP

GET
Brake Lathe Bench Kit
SKU 212739 | AMM902500
and
Model 2B Lathe Adapter Kit
SKU 496629 | AMM900002

VALUED AT
\$1,979.99

Offer Good Through
March 31, 2019
While Supplies Last



Silencer Bands

Large Solid Rotor Silencer Band (9")

SKU 262396
SHA94 **19⁹⁹**



Small Solid Rotor Silencer Band (6")

SKU 262393
SHA96 **19⁹⁹**

1-3/4" Drum Silencer Band

SKU 262390
SHA80B **34⁹⁹**



AMMCO Style Disc Silencer Band with Steel Weights

SKU 262392
SHA69 **34⁹⁹**

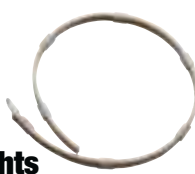

AMMCO Style Large Disc Band with Lead Weights

SKU 262397
SHA930 **44⁹⁹**



2-3/4" Large Truck Drum Silencer Band

SKU 262391
SHA5290 **54⁹⁹**



Silencer Clamp

SKU 388821
SHA70B **44⁹⁹**



SHARK USA

SHARK USA

Combination Brake Lathe RL8500 Complete Kit Includes Lathe, Adapters and Bench

SKU 901827
RANRL8500 **5,739⁹⁹**

Provides a **FASTER, More ACCURATE and EASIER** Resurfacing Capability Than Any Other Brake Lathe in its Class

- Infinitely Variable Speed Controller Able to Turn Rotors and Drums Faster Providing One-Cut, Micro-Finish Execution Every Time
- Maximum Rotor Diameter: 17"
- Maximum Rotor Thickness: 2-1/2"
- Brake Drum Diameter: 6" - 28"
- Maximum Load with Standard Arbor: 150 Lbs.
- Maximum Load with Truck Arbor: 250 Lbs.

Lift Gate Service

SKU 262533
RANLIFTGATE **95⁰⁰**

WARRANTY: 1 Year Parts and 1 Year Labor



(Shown with Optional Equipment. Accessories Not Included)

Truck Adapter Kit for RL8500 Brake Lathe

SKU 899411
RAN5150161 **1,439⁹⁹**

- Super-Duty Truck Tooling Package Consists of an Upgraded 1-7/8" Arbor and a Wide Variety of Adapters
- 36 Piece Set Allows Expanded Coverage to Handle Any Vehicle Through 1 Ton Trucks



Positive Rake Bits (10 Pack)

SKU 300786
SHA408-10 **64⁹⁹**



SHARK USA

Free Delivery in 48 Continental United States

Leasing Terms Available. Ask Your AutoZone® Commercial Sales Manager.

Carbide Lathe Inserts

SKU	PART#	DESCRIPTION	APPLICATION	PRICE
262385	SHA0626	Negative Rake (6 Pack) Models 3860, 4000, 4100 and 7000	Ammco	19⁹⁹
262387	SHA1042	Positive Rake (2 Pack) Model 3850	Ammco	19⁹⁹
262386	SHA06210	Negative Rake (10 Pack)	Ammco	29⁹⁹
262389	SHA06810	Positive Rake (10 Pack) Model BL500 and 501	Hunter	34⁹⁹
262388	SHA1046	Carbide Inserts (6 Pack)	Ammco	39⁹⁹
543384	SHA069-10	Positive Rake (10 Pack)	Pro-Cut	54⁹⁹
262382	SHA40710	Carbide Inserts (10 Pack)	FMC	54⁹⁹
262409	SHA80210	Carbide Inserts (10 Pack)	Kwik Way	64⁹⁹
300786	SHA408-10	Positive Rake (10 Pack)	FMC/ Ranger/ Accu-turn	64⁹⁹
262383	SHA06010	Carbide Inserts (10 Pack)	Accu-turn	54⁹⁹

BONUS \$69.99 ON REFILL KIT WITH PURCHASE OF BRAKE BLEEDING KIT #MITMV6830

877-AZTool1
877-298-6651
Hablamos Español
AZtool1.com

On-Car Brake Lathes

A10-6 On-Car Brake Lathe with 6 Adapter Package
 SKU OUTSIDE BUY/EPO PCTPCA10-6ADP **13,829⁹⁹**

- Includes: A10 Warthog Lathe, 6 Adapter Package and Full Accessory Kit (50-681, 50-687, 50-688, 50-693, 50-694, 50-946)
- Heavy Duty PTO Drive System Provides Twice the Startup Torque as Our Other Machines. Perfect for Fleet, Heavy Duty and High Car Demand!
- The 6 Adapter Package Will Fit Import and Domestic 4 Lug Applications Up Through 1/2 Ton Trucks
- On-Site Installation and Training Provided
- 2 Year Warranty



PCTPC92-6ADP

Pro-Cut Brake Lathes Correct Rotor Distortion, Rotor Misalignment and Cure Brake Vibration
 Call 1-877-298-6651 to Schedule an In-Shop Demo



PCTPCA10-6ADP

9.2DR0 On-Car Brake Lathe with 6 Adapter Package
 SKU OUTSIDE BUY/EPO PCTPC92-6ADP **10,999⁹⁹**

Available via Outside Buy/EPO. Call 1-877-298-6651 for Ordering Instructions
 Price does not include installation or optional equipment as shown

Sprayers

Red Powder Coated Aluminum Sprayer
 SKU 186463 MSMB8000PL **44⁹⁹**

- 16 Oz. Capacity
- Not for Use with Chlorinated Solvents
- Pressurize Up to 200 P.S.I.



Filler Cap Assembly
 SKU 186466 MSMP156 **19⁹⁹**

- Hand Removable
- For Model "A" Sprayers

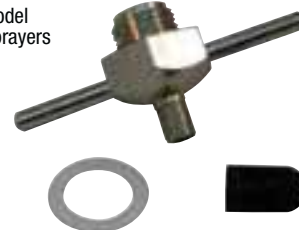

Complete Repair Kit for B8000PL
 SKU 186467 MSMBK50 **19⁹⁹**



Red Powder Coated Steel Sprayer
 SKU 186459 MSMA1000R **69⁹⁹**

- 32 Oz. Capacity
- Not for Use with Water-Based Products
- Pressurize Up to 200 P.S.I.



Complete Repair Kit for Model "A" Sprayers
 SKU 186465 MSMK10 **29⁹⁹**

- Includes All Parts That Can Be Replaced
- All Chemical Resistant Seals
- Used for Model A1000R and A2000 32 Oz. Sprayers



Brake Bleeding Tools

One Man Brake Bleeding Kit
 SKU 070116 25136 **34⁹⁹**

- Easily Diagnose Vacuum and Pressure Related Systems from the EGR to Brake Bleeding on Today's Complex Vehicles
- Kit Contains Our Most Popular Hand Vacuum Pump with Vacuum Gauge and Accessories



Product May Vary

STORE STOCKED

Universal Fluid Dispensing Bottle
 SKU 568477 24443 **39⁹⁹**

- Refill the Master Cylinder During Vacuum or Manual Hydraulic Brake or Clutch Bleeding and Flushing
- Mounts Securely to Master Cylinder and Clamps
- Capacity: 50 Oz.



Vacuum Brake Bleeder
 SKU 526506 24440 **49⁹⁹**

- Works with Your Air Compressor to Quickly Bleed Clutches and Brakes on Most Cars and Trucks
- Includes Fill Bottle and Master Cylinder Adapter Set



DIY Reverse Brake and Clutch Bleeder
 SKU 459112 PH02104-B **59⁹⁹**

- Easily Bleeds ABS
- Removes Trapped Air
- Attachments to Fit All Vehicles



Refill Kit
 SKU 972280 MITMVA6832 **69⁹⁹**

- 40 Oz. (1.2 L) Reservoir Holds Enough Fluid for an Entire Flush
- On/Off Valve Controls Fluid Flow From Reservoir
- Fluid Level Control Maintains Correct Level of Fluid in the Master Cylinder
- Conveniently Adapts for Use with Standard 12 Oz. (355 MI) and 32 Oz. (946 MI) Brake Fluid Bottles
- Universal Top-Mount Design



Silverline Elite Test Kit
 SKU 988888 MITMV8500 **99⁹⁹**

- Provides Either Vacuum or Pressure with Equal Precision and Convenience
- Performs Engine Performance Diagnostics, Brake Bleeding, Fluid Transfer, Evacuation, Sampling and More
- Includes Components Needed to Perform Hundreds of Diagnostic and Mechanical Tests



Brake Bleeding Kit
 SKU 604208 MITMV6830 **199⁹⁹**

- Compressed Air Operation
- 1.9 Quart Capacity
- Swivel Air Inlet with Quick Disconnect



BONUS VALUE: \$69.99

Refill Kit
 SKU 972280 MITMVA6832
 With Purchase of:
Brake Bleeding Kit
 SKU 604208 | MITMV6830
 Offer Good Through March 31, 2019 While Supplies Last

Pressure Brake Bleeding System
 SKU 383099 MITMV6840 **409⁹⁹**

- Large 1.2 Gallon Capacity Dispenser
- Includes 7 Master Cylinder Adapters That Connect to Most U.S., Asian, and European Cars and Light Trucks
- Pressure Gauge Indicates Dispensing Pressure
- Utilizes Push-to-Connect, Quick-Change Adapters
- Integrated Manual Relief Valve For Safety



V-12 Economy Professional Reverse Brake and Clutch Bleeder
 SKU 289898 PH02003 **189⁹⁹**

- Bleed the Brakes on Any Vehicle in 10 Minutes or Less, Including ABS
- Save Time and Money on Good Parts Not Properly Bled
- One Man Operation



MaxProHD® Reverse Brake and Clutch Bleeder
 SKU 289896 PH02002 **399⁹⁹**

- Bleeds Brakes or Clutches in Half the Time
- Includes a Full Set of Adapters for Vacuum, Pressure, Pulse Generation, Bench and Cross Bleeding Methods



BRAKE SERVICE

Disc Brake Tools

Quick Quad Pad Spreader

SKU 080553 **79⁹⁹**
LIS29100

- A Quick Way to Spread Brake Pads and Compress Disc Brake Pistons for Pad Replacement on Single, Double and Quad Piston Calipers
- Simultaneously Compress All Four Pistons on Quad Piston Applications
- Can Be Used While Caliper is on the Vehicle or Hanging Free



Dual Speedy Pad Spreader

SKU 291420 **49⁹⁹**
LIS25750

- Compresses Dual Brake Pistons Simultaneously
- Makes Dual Piston Pad Replacement a Simple Job



Speedy Pad Spreader

SKU 291417 **42⁹⁹**
LIS24300

- Compresses Disc Brake Pistons in Seconds
- Makes Brake Pad Replacement Easier



Rotor Flex-Hone®

- Lowers Harmonic Vibrations
- Ideal for New and Re-Turned Rotors and Flywheels

Fine
SKU 341310 **44⁹⁹**
BRMRMFH240Z25

Medium
SKU 341298 **44⁹⁹**
BRMRMFH120Z25

Coarse
SKU 341314 **44⁹⁹**
BRMRMFH60Z25



Brake Hub Resurfacing Kit

SKU 013590 **20⁹⁹**
24686

- Quickly Remove Rust on Lug Studs and Rotors on the Hub Assembly
- Use with Drill for a Quick and Easy Job
- Fits All Passenger Cars, Light-Trucks and SUVs
- Includes 4 Pads



STORE STOCKED

Dual Piston Press

SKU 900811 **29⁹⁹**
25741

- Used to Press in Dual Brakes and Single Pistons

Style May Vary



2 and 3 Pin Brake Rewind Adapter Set

SKU 013592 **34⁹⁹**
24693

- Includes 2 Fully Adjustable Adapters That Fit Thousands of Vehicles
- No Need for Multiple Tools
- 3/8" Drive Adapters



STORE STOCKED

18 Piece Disc Brake Caliper Set

SKU 094798 **54⁹⁹**
27113

- Caliper Adapters from 1-3/16" to 2-1/2", Some Specifically to Service Nissan, SAAB and Honda Models
- Caliper Rotation Tool with Left Hand Threads for Ford Applications



Brake Service Tools

Brake Caliper Brush

SKU 250125 **5⁹⁹**
25435

- Slim Design for Cleaning Brake Calipers and Other Brake Hardware



STORE STOCKED

2 Piece Hose Pinchers

SKU 191675 **9⁹⁹**
25250

- A Quick, Easy Way to Pinch-Off Vacuum Lines, Fuel Lines, etc. Without Damaging the Line



Brake Cylinder Retainer Remover

SKU 265111 **12⁹⁹**
25268

- Use on GM X and J Body Cars
- Expands and Holds Special Retainer So the Brake Cylinder May Be Removed



8 Piece Manual Brake Gauge Set

SKU 191672 **14⁹⁹**
25266

- Color Coded Brake Gauge Identifies Thickness Levels for Brake Lining Inspection



Spring Brake Tool for GM

SKU 222526 **34⁹⁹**
LIS50600

- Releases Tension on Both Large and Small GM Single Spring Brakes During Servicing

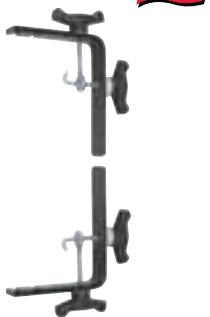

8 Piece Brake Tool Set

SKU 900827 **49⁹⁹**
27194

- Includes: Spring Compressor, Brake Spring Installer, Spring Removal Tool, Brake Retaining Spring Tool, Brake Spring Pliers, (2) Brake Adjustment Spoons and Mini Adjustment Spoon



Brake Drum and Rotor Puller

SKU 087311 **139⁹⁹**
OTC6980

- Handles Large Components Such as Brake Drums, Rotors, Drive Gears, Flywheels, and Pulleys
- One Person Can Easily Set the Tool in Place and Use for Tough Pulls Even Where There is Little Access to Insert the Jaws
- Spreads to 12-3/4" and 5" of Reach
- 7 Tons of Force, Yet Weighs Less Than 10 Lbs.
- Can Be Used with Air Tools to Reduce Time and Fatigue



Hones and Stones

Flex-Hone® Kit BC Kit D 180SC

SKU 341378 **69⁹⁹**
BRMBCKD

- BC Kit D (18 mm, 20 mm, 22 mm, 25 mm, 29 mm)



Adjustable Brake Cylinder Hone

SKU 531780 **14⁹⁹**
25032

- Range: 1/2" to 2-1/4" (13 mm to 57 mm)



Brake Cylinder Hone 3/4" to 2-1/2"

SKU 047928 **18⁹⁹**
25028

- Range: 13/16" to 2-1/4" (21 mm to 58 mm)



Replacement Stone Sets

SKU 046789 **5⁹⁹**
2528M

- 2 Medium Grit (#220)



Code Scanner and Reader

MaxiService EBS301 Electric Brake Service Tool

SKU 255733 **209⁹⁹**
AULEBS301

- Opens and Closes Brake Calipers for Pad Replacement
- Read / Clear EPB/SBC Codes
- Turn Off ECU and Brake Warning Light
- Compatible with Domestic, Asian, and European Vehicles Equipped with EPB Systems
- Free Software Updates for the Life of the Tool



Brake Spring Tool

Brake Caliper Hanger Set - 8 Piece

SKU 312538 **24⁹⁹**
24518

- Prevents Kinking or Premature Failure of Brake Hose
- Keeps Calipers Up and Out of the Way When Servicing Suspension Components, Brakes, etc.
- Hi Viz Green Powder Coat So You Don't Misplace Them or Leave Them Attached to the Vehicle



Fluid Exchangers

Brake Flush System

SKU 850060 **3,789⁹⁹**
MSSBFX3

- 3-Step Process Takes Less Than 10 Minutes
- Universal Adapter for Variety of Master Cylinders Included
- Includes Pistol Wand for Convenient and Accurate Fill
- Pressure Gauge to Assist in Brake System Diagnosis



Fluid not included

MAHLE

Brake-Maxx Brake Fluid Exchanger w/ Startup Kit

SKU 032793 **3,229⁹⁹**
MXMMX8COMBO

- Simultaneously Exchanges and Bleeds Air from Master Cylinders and ABS System
- Energy Saving—No Electricity or Batteries Required
- Eliminates Spills
- Includes 13 Adapters for Versatile Application
- Startup Kit Includes 24 Bottles of DOT 3 or DOT 4 Brake Fluid



Brake-Maxx Brake Exchange Machine only

SKU 912313 **2,889⁹⁹**
MXMMX8



OIL CHANGE

877-AZTool1
877-298-6651
 Hablamos Español
AZtool1.com

Lincoln® Oil Drains



18 Gallon Rolling Oil Drain

SKU 988882
 LIN3601 **259⁹⁹**

- All Steel Design Includes Reinforced Caster Supports
- 14" Telescoping Bowl: Range of 45" - 72"
- Preset Air Regulator (Up to 150 PSI)
- Pressurized Self-Evacuation Feature Requires Only Shop Air and a Tire Chuck to Discharge Fluids



OEMTOOLS™ Oil Drains

21 Gallon Waste Oil Drain

SKU 544817
 24861 **429⁹⁹**

- Large Diameter Funnel That Includes a Removable Filter Screen and Wide-Mouth Extension
- Funnel Diameter: 15"
- Funnel Extension Diameter: 22"
- Funnel Height Adjustment: 45" - 62"



BONUS
 VALUE: \$129.99

121 Pc. Mechanic's Tool Set

SKU 850892
 23984

With Purchase of:
21 Gallon Waste Oil Drain
 SKU 544817 | 24861
OR 21 Gallon Oil Drain and Vacuum Evacuator
 SKU 546658 | 24862

Offer Good Through March 31, 2019 While Supplies Last

21 Gallon Oil Drain and Vacuum Evacuator



SKU 546658
 24862 **499⁹⁹**

- Designed for Collection of Motor Oil, Transmission Fluid and Coolant from Under Lift-Mounted Vehicles or By Evacuation from Fluid Reservoirs or Through Dipstick Tubes
- Funnel Diameter: 15"
- Funnel Extension Adapter: 22"
- Funnel Height Adjustment: 45" - 62"

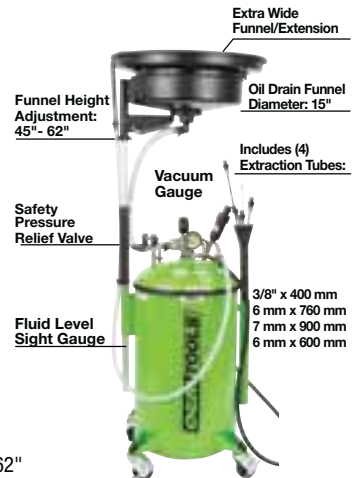

25 Gallon Used Fluid Combo Drain/Evacuator

SKU 543345
 LIN3639 **519⁹⁹** REG. \$599.99

SAVE \$80

- Powerful Compressed Air Operated Venturi Vacuum Quickly Draws Fluids from Reservoirs
- Includes Mercedes-Benz, BMW and VW Dipstick Tube Adapters and (6) Evacuation Wands of Varying Flexibility, Diameter and Length
- Pressurized Self-Evacuation Feature Requires Only Shop Air and a Tire Chuck to Discharge Fluids



Offer Good Through March 31, 2019 While Supplies Last

9 Gallon Upright Portable Oil Drain

SKU 908386
 87032 **69⁹⁹**

- Funnel Diameter: 17"
- Features Built-in Drain Valve and Evacuation Spout



18 Gallon Upright Portable Oil Drain

SKU 908388
 87031 **99⁹⁹**

- Funnel Diameter: 18"
- Features Built-in Drain Valve and Evacuation Spout



BONUS
 VALUE: \$34.99

Drain Plug Socket Set

SKU 818568 | 25374

With Purchase of:
9 Gallon Upright Portable Oil Drain
 SKU 908386 | 87032
OR 18 Gallon Upright Portable Oil Drain
 SKU 908388 | 87031

Offer Good Through March 31, 2019 While Supplies Last

Used Fluid Drain



- Durable, High-Density Polyethylene Reservoir
- Reservoir's Flat-Top Design Holds Drain Filters, Tools, Nuts, Bolts, etc.
- Quick-Adjustment Clamp Enables Simple Raising and Lowering of the Drain Funnel
- Splashguard for Overspray Protection
- Optional Cam Lock Evacuation Kit for Use with Diaphragm Pump Systems

18 Gallon

SKU 606546
 LIN3518 **219⁹⁹**

- 18 Gallon Used Fluid Drain
- Drain Adjusts from 40" to 77" (101.6 cm to 195.5 cm) in Height



8 Gallon

SKU 606539
 LIN3508 **144⁹⁹**

- Drain Adjusts from 36" to 65" (91 to 165 cm) in Height



JohnDow HD Oil Drains



17 Gallon Low-Profile Oil Drain

SKU 360666
 DOWJDILP4 **459⁹⁹**

- 17-Gallon Evacuation Capacity
- 10" Ground Clearance
- Expanded Metal Shield Reduces Splash
- Emptied by Gravity Drain, Evacuation Pump or Air Evacuation



BONUS VALUE: \$199.99

Shop Air Evacuation Kit

SKU 360667 | DOWJDIEK

With Purchase of:
17 Gallon Low-Profile Oil Drain
 SKU 360666 | DOWJDILP4

Offer Good Through March 31, 2019 While Supplies Last

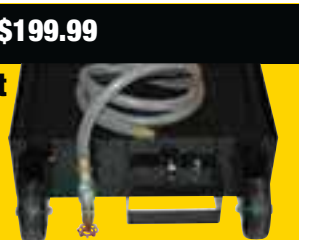

Low Profile Oil Drains



17 Gallon Low Profile Truck Drain with Electric Pump

SKU 526487
 LIN3669 **539⁹⁹**

- Features a Durable 120V Electric Pump Installed Below the Front of the Reservoir
- Pump Operates with a Standard Power Outlet and Discharges Fluid Through a 6' Hose with Steel J-Hook

17 Gallon Low Profile Truck Drain with Hand Pump

SKU 526485
 LIN3667 **419⁹⁹**

- Features a Rotary Hand Pump and a 6' Discharge Hose with a Steel J-Hook

17 Gallon Low Profile Truck Drain

SKU 526486
 LIN3665 **319⁹⁹**

- 6' Hose Extends from the Bottom of the Reservoir and Can Be Connected to a Pump to Evacuate Fluid from the Drain



BONUS VALUE: \$15.99

14" Adjustable Oil Filter Pliers

SKU 757057 | 25324

With Purchase of:
17 Gallon Low Profile Truck Drain with Electric Pump
 SKU 526487 | LIN3669

OR 17 Gallon Low Profile Truck Drain with Hand Pump
 SKU 526485 | LIN3667

OR 17 Gallon Low Profile Truck Drain
 SKU 526486 | LIN3665

Offer Good Through March 31, 2019 While Supplies Last



Accessories



Transmission Drain Pan

SKU 908383
 87035 **14⁹⁹**

- Flexible Plastic Construction
- Fits on Top of Funnels of Most Lift Drains
- Built-in Screen to Catch Debris, Parts and Tools

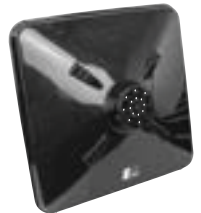

Super Transmission Drain Funnel

SKU 291377
 LIS17902 **54⁹⁹**

- Extends the Catch Area of Any Lift Drain
- Fits the Ford E 40D



No Splatter Pads

- Insert Pad in Funnel or Pan Before Oil Change to Eliminate Oil Splatter
- Porous Material Allows Fluid to Quickly Pass Through into Funnel or Pan

15" Round

SKU 080548
 LIS38750 **16⁹⁹**



22" Square

SKU 080574
 LIS38780 **24⁹⁹**



OIL CHANGE

OEM TOOLS™

No-Spill Oil Funnel

SHOP SUPPLY of the MONTH

FEBRUARY

SEE INSERT FOR DETAILS

- Funnel Screws Directly into Filler Neck
- Threaded to Fit a Range of Import and Domestic Vehicles, Older and Current Models
- Transparent Lower Chamber to Monitor Oil Flow
- Wide Passage for Rapid Refilling

Direct Fit Oil Funnel Set

SKU 824884
87039 **69⁹⁹**

- Set Includes: Universal Oil Funnel, Chrysler (87019), Ford/Mazda (87020), GM (87021), Honda (87022), Toyota/Lexus (87024), Subaru Adapter, Toyota/Lexus Adapter, and 150° Extended Adapter (87027)



Direct Fit Individual Funnel



SKU	Part #	Description	Price
824879	87021	GM and BMW	14.99
824887	87036	Flat	14.99
824890	87022	Honda, Acura and Nissan	19.99
824885	87020	Ford, Mazda and Mercury	14.99
824888	87023	Subaru	19.99
824892	87019	Chrysler, Dodge and Jeep	14.99
824886	87024	Toyota, Lexus, VW and Mercedes-Benz	19.99

Fast-Clamp Universal Oil Funnel

SKU 825017
87037 **27⁹⁹**

- Securely Clamps into Filler Neck; No Need to Hold Funnel in Place During the Refilling Process
- Transparent Lower Chamber to Monitor Oil Flow
- Clamp Can Be Used with Standard Funnel



150° Extended Adapter

SKU 858487
87027 **9⁹⁹**

- Threaded to Screw Directly onto the 87022 Honda No-Spill Oil Funnel
- For Vehicles with Angled Filler Necks in Narrow Spaces
- Fits Honda Odyssey and Pilot; Acura MDX, RDX and ZDX



Bottle Seal Piercer

SKU 824883
87028 **9⁹⁹**

- Securely Holds Bottle Upright—Allowing Hands-free Refilling
- Fits All OEMTOOLS™ No-Spill Funnel
- Mesh Screen Keeps Seal Fragments and Debris from Entering Filler Neck



Drain Pans

2.8 Quart Low Profile Oil Drain Pan

SKU 568474
87017 **7⁹⁹**

- Low Profile Oil Drain Pan



4 Gallon Oil Drain Pan Green

SKU 908389
87034 **12⁹⁹**

- Heavy Duty Polyethylene Construction
- Features a Pour Spout and No-Splash Lip



Black
SKU 908382
87033 **12⁹⁹**

4.5L Oil Drain Pan Clear with Level Scale

SKU 568469
87013 **6⁹⁹**

- Great for Transmission Fluid Changes
- Built-in Level Scale Lets You See Fluid Levels



Drum Drain Basin for 5 to 8 Gallon Bucket

SKU 568471
87014 **21⁹⁹**

- Ribbed Drainage Channels
- Filter Gate to Catch Foreign Objects
- Capacity: 3.2 Quarts



Bucket not included

Drum Drain Basin for 55 Gallon Drum

SKU 568472
87015 **44⁹⁹**

- Fits on Top of Standard Size 55 Gallon Drums
- Filter Gate to Catch Foreign Objects
- Size: 26" Diameter
- Capacity: 21 Quarts



Drum Not Included

Cap Style Filter Wrenches

10 Piece Cap Filter Wrench Set

SKU 900828
27196 **32⁹⁹**

- (10) 3/8" Drive Cap Oil Filter Wrenches
- Includes: 65/67 mm – 14 Flutes, 80 mm – 15 Flutes, 68 mm – 14 Flutes, 86 mm – 16 Flutes, 74/76 mm – 15 Flutes, 93 mm – 15 Flutes, 76 mm – 14 Flutes, 93 mm – 36 Flutes, 76 mm – 30 Flutes, 100 mm – 15 Flutes



Individual Filter Wrenches

SKU	Part #	Description	Price
548391	25400	"A" Cap (74/76 mm, 15 Flutes)	6.99
548392	25401	"B" Cap (76 mm, 14 Flutes)	6.99
548393	25402	"C" Cap (93 mm, 15 Flutes)	6.99
548394	25403	"D" Cap (93 mm, 36 Flutes)	6.99

SKU	Part #	Description	Price
548395	25404	"F" Cap (65-67 mm, 14 Flutes)	6.99
344316	25405	"G" Cap (68 mm, 14 Flutes)	6.99
344318	25406	"H" Cap (80 mm, 15 Flutes)	6.99
548396	25407	"I" Cap (74 mm, 15 Flutes)	6.99

Professional Cap Style Filter Wrenches

9 Piece Oil Filter Cap Wrench Set

SKU 255627
27199 **94⁹⁹**

- 3 Forged Low Profile Socket Wrenches Included: 27 mm, 32 mm and 36 mm
- 5 High Quality, Chrome Plated Aluminum Wrenches: 1 Adjustable, 63 mm to 83 mm Sizes and a Filter Wrench for Universal Applications
- 3/8" Square Drive
- Includes Application Chart



Oil Filter Cap Wrenches



SKU	Part #	Applications	Size	Price
383456	25408	2006 BMW Series (E90) and All 1999 - 2005 Volvo Cars (Except 2005 40 and 50 Series)	86.5 mm, 16 Flutes	9.99
255669	25452	BMW Models equipped with a M44 engine, Mercedes (M 102 & 103 engine, Porsche (924 & 944), VW/Audi	74.2 mm, 14 Flutes	9.99
255675	25453	BMW (N52, N54, N55, N63 Engines - 2006 to 2012), Volvo (All Models except 2005 40 and 50 Series)	64.5 mm, 14 Flutes	12.99
255659	25454	Hyundai, Kia	88.8 mm, 15 Flutes	14.99

Toyota/Lexus Oil Filter Cap Wrench Set

SKU 383457
25409 **26⁹⁹**

- Sizes: 64 mm, 73 mm and 74 mm
- Use in Conjunction with a 22 mm or 7/8" Socket or Wrench

OEM TOOLS™

Toyota-Lexus 64 mm Oil Filter Cap Wrench

SKU 082944
OEM25412 **9⁹⁹**

Toyota/Lexus 64.5 mm Oil Filter Cap Wrench

SKU 255634
25451 **9⁹⁹**



Oil Filter Sockets

7 Piece Oil Filter Removal Wrench Set

SKU 191682
27197 **29⁹⁹**

- 3/8" Drive
- Includes: 24 mm for Cadillac; 27 and 36 mm for Mercedes-Benz, VW, Cadillac, Buick, Saturn, SAAB; 29 mm for Dodge Cummins Fuel Filter; 30 mm for Korean Cars; 32 mm for GM, Saturn and SAAB; 35/36 mm for Ford Diesel, Mini Cooper, BMW and Mack; 38 mm for Vauxhall/Vectra



3 Piece Low Profile Oil Filter Socket Set

SKU 094803
27204 **19⁹⁹**

- Includes 27, 32 and 36 mm
- 3/8" Drive
- Comes in a Blow Mold Case



SKU	Part #	Description	Price
255714	25450	27 mm Oil Filter Socket	7.99
548385	25410	32mm Oil Filter Cap Socket	7.99
110279	25411	36 mm Oil Filter Socket for 6.0L Ford Diesel	7.99

32 mm and 36 mm Double Sided Oil Filter Socket

SKU 020797
25421 **8⁹⁹**

- 3/8" Drive
- Applications: VW TDI [2011-2016], Touareg and VR6 Motors [2009-2016]; Audi Q3 and S3 with 2.0 T Gas [2015-2016]; Q7 [2007-2010] and A6 3.0T [2014-2016]; BMW 335d, X5 35d [2009-2011] and BMW 6 and 8 Cylinder Engines [1994-2005]; Volvo Models [2007-2014]; Chevy Cobalt, Impala and Malibu with 2.2 and 2.4 Liter Engines [2007-2014]; Porsche Models [2009-2016]

Double Sided Socket



8-in-1 Oil Drain Swivel Wrench - SAE

SKU 110284
25378 **12⁹⁹**

- 8 Sizes in 1 Tool
- Features Magnet to Hold
- Ideal for Drain Plugs or Nuts
- Easy-to-Use Swivel Head Fits All Angles
- Go-Thru Swivel Head Works in Tight Areas
- SAE: 8 Socket Sizes in One Tool: 3/8", 7/16", 1/2", 9/16", 5/8", 11/16", 3/4" and 13/16"



Cam Action Filter Wrenches

3 Legged Oil Filter Wrench

SKU 548382
 OEM25017 **7⁹⁹**

- Fits Import Cars
- Fits Spin-on Filters 2-1/2" - 3-7/8"



3 Jaw Adjustable Magnetic Oil Filter Wrench

SKU 908387
 25101 **14⁹⁹**

- Oil Filter Diameter: 2.4" to 3.6" (60 mm to 93 mm)
- Includes 3/8" to 1/2" Drive Adapter
- Magnetic Attachment
- Spring-Loaded Legs for a Secure Grip



OEM TOOLS™

3/8" Drive - 2 1/2" to 3 1/8" Range

SKU 548378
 25128 **6⁹⁹**

- Fits Almost All Import Car Filters and the More Common 3" Domestic Car Filters
- Uses 3/8" Drive
- Fits Oil Filters 2-1/2" to 3-1/8"



Professional 3 Legged Filter Wrench

SKU 231212
 25413 **12⁹⁹**

- Range: 2-1/2" to 4-1/2" (63.5 mm to 114 mm)
- Fits 3/8" Drive Ratchet and Extensions



Dispensers

OEM TOOLS™

5 Quart Translucent Oil Dispenser

SKU 544816
 87011 **17⁹⁹**

- Translucent White Material Enables the User to See the Liquid Level
- Includes Flexible Spout



10L Oil Jug

SKU 605325
 87018 **24⁹⁹**

- Safe for Automotive Oils and Fluids
- Convenient Carry and Pour Handles
- Spill Proof Caps



OEM TOOLS™

8 Quart Dispenser Lid and Cap

SKU 080078
 LIS19702 **29⁹⁹**

- Spout Cap and Lid to Keep Out Contaminants
- Many Large SUVs and Trucks Now Require More Oil



Flexible Spout Measuring Cans

- Designed for One-Hand Operation
- 14" Flexible Spout with Tapered Tip
- Recessed Bottom Drains Fully and Guards Against Punctures Rolled-Edge Top Helps Prevent Spilling

5 Quart
 SKU 298486
 LING525 **39⁹⁹**

8 Quart
 SKU 298473
 LING528 **44⁹⁹**



LINCOLN®

Oil Funnels



8 Qt Galvanized Steel Funnel

SKU 824875
 87040 **17⁹⁹**

- Capacity: 8 Quarts (2 Gal, 7.57 L)
- Includes Mesh Screen to Help Filter Large Debris from Passing Through the Funnel



4 Piece Oil Drain and Funnel Set

SKU 754740
 68985 **24⁹⁹**

- Includes: Oil and Transmission Funnel (#87008); 850 cc Square Oil Funnel (#87012); Drain Pan with Level Scale (#87013) 13.8" x 12.6" x 4.3"; 2.8 Quart Low Profile Oil Drain Set (#87017)



Oil and Transmission Funnel

SKU 547009
 87008 **9⁹⁹**

- Straight and 45 Degree Angle
- Screen to Prevent Trash from Entering Transmission
- Dust Cover to Keep Funnel Clean

OEM TOOLS™



Square Oil Funnel

SKU 568467
 87012 **3⁹⁹**

- Minimize Spills with the Unique Funnel Designed to Fit Most 1 Quart Plastic Oil Bottles
- Funnel Body Dimensions: 5-1/2" (L) x 3" (W)
- Depth: 2-1/2"
- Funnel Spout Diameter: 1"
- Funnel Spout Length: 2"
- Capacity: 1 Quart
- Hook for Hanging
- Always Dispose of Oil Responsibly

Filter Pliers

OEM TOOLS™

14" Adjustable Oil Filter Pliers

SKU 757057
 25324 **15⁹⁹**

- Removes Stubborn Oil Filters from Gas or Diesel Engines
- Suitable for Filters with 2.4" - 5" Diameters
- Long Reach Slip Joint Design
- Precision Machined Jaw
- Non-Slip Comfort Grip



10" Master Oil Filter Locking Pliers

SKU 850037
 25323 **19⁹⁹**

- Capacity: 2-1/8" to 4-1/2" (55 to 120 mm)
- Length: 10" (200 mm)
- Provides Ability to Turn without Squeezing
- Removes Oil Filters in Hard-to-Reach Areas



Oil Filter Pliers 2-1/2" to 4-5/8"

SKU 548380
 25320 **9⁹⁹**



Color May Vary

Filter Pliers

CHAN NEL LOCK

2 Piece Oil Filter Plier Set

SKU 081329
 CHA0F-1 **49⁹⁹**

9 Inch Oil Filter Pliers

SKU 081324
 CHA209 **16⁹⁹**

12 Inch Oil Filter Pliers

SKU 081325
 CHA212 **23⁹⁹**

15.5 Inch Oil Filter Pliers

SKU 081326
 CHA215 **27⁹⁹**



HD Filter Wrench

OEM TOOLS™

Heavy Duty Truck Oil Filters

- Heavy Duty Design for Durability and Strength
- Extra Wide Band for Secure Grip
- Use 1/2" Drive Tools



SKU	Part #	Description	Price
344322	25231	Small	9.99
344323	25232	Medium	9.99
344324	25233	Large	9.99

Heavy Duty Oil Filter Wrench

SKU 344321
 25129 **6⁹⁹**

- Heavy Duty Strap Seat with Dual Rivet Design
- Fits Oil and Gas Filters 3-1/2" to 3-7/8"



15" Chain Wrench

SKU 452624
 22659 **34⁹⁹**

- Great for Stubborn Oil Filters
- Designed for Tight Spaces
- Double-action Allows Use in Either Direction



Filter Wrenches

OEM TOOLS™

Strap Oil Filter Wrench

SKU 72843
 25079 **5⁹⁹**

- Remove Spin-On Type Filters Up to 6 Degrees in Diameter
- Strong Wide Nylon Belt for a Strong, No-Slip Grip



4-5/16" to 4-3/4" Truck Swivel Oil Wrench

SKU 210207
 25365 **8⁹⁹**

- Dimpled Ban for Additional Grip



4-in-1 Steel Oil Filter Wrench

SKU 081311
 25447 **9⁹⁹**

- Size Range 2-3/8 Inch to 4-3/8 Inch (60.3 mm to 111.1 mm)
- One Swivel Handle with Four Stainless Steel Bands
- Bands are Easily Removed and Installed



Oil Drain Plug Service

OEM TOOLS™

14 Piece Drain Plug Socket Set

SKU 818568
 25374 **34⁹⁹**

- Designed for Both Foreign and Domestic Vehicles Including: BMW, Ford, Mazda, Mercedes-Benz, Nissan, Peugeot, Renault and More
- Ideal for Removal of Oil Drain Plugs from Manual Transmissions, Transfer Cases, Differential Housings and More
- Includes: (Hex) 9, 10, 12, 14 and 17 mm; (Square) 7, 8, 11, 13 mm, 5/16", 3/8"; (Female Square) 10 mm; (Male Triangle) 10 mm, (Tamper-Proof Triple Square) 16 mm



SMART-O™ 38 Plug Starter Kit

SKU 404638
 BRA38 **119⁹⁹**

- High Performance Seal and Lock for Fast and Foolproof Installation
- Kit Contains 38 Plugs Compatible with 99.9% of Vehicles
- Unified Torque
- Oil Loss Prevention
- Oil Pan and Engine Protection
- Eco-Protection



SMART-O™
 THE INTELLIGENT DRAIN PLUG



SMART-O™ 74 Plug Starter Plug Kit

SKU 404637
 BRA74 **269⁹⁹**

- Kit Includes 74 Plugs with Washers: 10 Each: F1, F3, R1, R6, 6 Each: R3, 4 Each: R9, R20, 2 Each: R4, R5, R11, R16, R21, R22, R23, R24, S13, S18

WE CARRY A FULL LINE OF SMART-O DRAIN PLUGS

FLUID HANDLING

BONUS JOHN DOW FUEL TANK ADAPTER WITH 25 GAL. STEEL GAS CADDY

OEMTOOLS™ Fluid Evacuators

Fluid Evacuator (1.4 Gallon)

SKU 544744
24389 **59⁹⁹**

- 5 Ft. of Flex Hose and 2 Dipstick Hoses
- Use to Extract Most Fluid Types: Engine Oil, Transmission Fluid, Gear Oil, Coolant, Power Steering Fluid



Fluid Evacuator (2.5 Gallon)

SKU 547010
24397 **99⁹⁹**

- Extracts All Types of Engine, Transmission and Lubricating Oils
- Extracts Fluids Through Dipstick Tubes as Well as Other Openings
- Float Assembly to Prevent Overflow



Brake Bleeder Adapter Hose for Fluid Evacuators 24389 and 24397

SKU 568479
24446 **14⁹⁹**

- Quickly Connects to OEMTOOLS™ Models 24389 or 24397 Fluid Evacuators Converting Them into One-Person Vacuum Brake or Hydraulic Clutch Bleeders

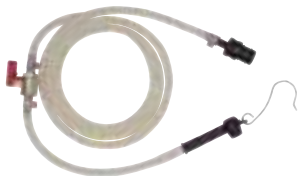

Lincoln Fluid Evacuators

PneumatiVac Fluid Evacuator (2.3 Gallon)

SKU 497203
MITMV7300

149⁹⁹

- Operates on Compressed Air
- Independent Air Shut-Off Valve



Fluid Evacuator Plus

SKU 497200
MITMV7201

139⁹⁹

- Evacuates or Dispenses at the Push of a Button
- Integrated 2.3 Gallon (8.8 liter) Capacity Reservoir
- Durable, Chemical Resistant Polyethylene Construction
- Dipstick Tube Adapters Included



Fluid Evacuator (1.9 Gallon)

SKU 594882
MITMV7400

99⁹⁹

- Integrated 1.9 Gallon (7.3 Liter) Capacity Reservoir



Fluid Extractor

SKU 606542
MITMVA6851

34⁹⁹

1.5L Fluid Extractor/Dispenser

SKU 606541
MITMVA6852 **59⁹⁹**



Fluid Management

ATF Refill and Universal Fluid Dispensing System

SKU 526508
24441 **119⁹⁹**

- Complete System for Servicing Sealed Automatic Transmissions
- Includes Adapters to Fit Ford, BMW, Honda, Nissan, VW, Porsche, Mini Cooper, Audi and Mercedes-Benz Transmissions



Universal Fluid Dispensing System

SKU 265093
MITMV6400 **199⁹⁹**

- Large 1.2 Gallon (5-liter) Fluid Capacity
- Integrated Manual Pump Adds Air Above the Fluid Level to Prevent Aeration
- Pressure Gauge Indicates Fluid Dispensing Pressure
- Safety and Manual Pressure Relief Valve



Automatic Transmission Refill System

SKU 265092
MITMV6410 **339⁹⁹**

- Includes: Reservoir Lid with Integrated Manual Pump, Pressure Gauge, and Pressure Relief Valve, 5 Ft. Fluid Dispensing Hose, MVA5800 ATF Refill Adapter Kit, Fluid Dispensing Wand and Hanging Hook



ATF Adapter Kit

SKU 972278
MITMVA7216 **174⁹⁹**

For Use with the MITMV6410; Or Pair with the MITMVA6852 for a Low-Cost Refill System

- 10 Adapters Fit Ford, Toyota, BMW, Honda, Nissan, VW, Audi and Mercedes Transmissions



Lever Action Pumps

Hand Oil Pump

SKU 462495
24381 **19⁹⁹**

- Oil Pump for Use with Oil-Based Fluids, Heating Oils, Motor Oils, Heavy and Light Oils, Diesel and Kerosene
- Built-in 1-1/2" and 2" Bung for Use on 16 to 55 Gallon Drums with Either Opening
- Not for Gasoline

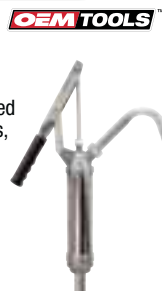

Lever Action Barrel Pump - Polypropylene Stainless Steel Rod

SKU 688038
24472 **29⁹⁹**

- Ideal for Pumping Diesel, Oils, Kerosene, Water-Based Chemicals, Bases and Mild Acids
- Not for Gasoline or DEF



Lever Action Barrel Pump - Ryton® Stainless Steel Rod

SKU 688037
24473 **39⁹⁹**

- Ideal for Pumping Diesel, Oils, Kerosene, Water-Based Chemicals, Bases and Acids Including DEF
- Not for Gasoline



Lever Action Barrel Pump

SKU 970530
LIN1340 **64⁹⁹**

- Pumps Non-Corrosive Fluids, Not for Gasoline
- Telescoping Tube for 16 to 55 Gallon Drums
- Removable Non-Drip Spout Allows for Threaded Hose Connection



Rotary Pumps

Rotary Barrel Pump

SKU 462486
24382 **30⁹⁹**

- Fluid Transfer Pump for Use with Oil-Based Fluids, Heating Oils, Motor Oils, ATF, Diesel and Kerosene
- Not for Gasoline



Polypropylene Rotary Drum Pump

SKU 688035
24470 **59⁹⁹**

- Ideal for Pumping Diesel, Oils, Kerosene, Water-Based Chemicals, Bases and Mild Acids
- Not for Gasoline or DEF



Manual Rotary Pump with Hose for 55 Gallon Drums

SKU 265089
LIN1385H **249⁹⁹**

- Includes: 8 Ft. x 3/4" Anti-Static Hose with Non-Sparking Aluminum Nozzle with Hanger; Seal Tight Telescoping Pick-Up Tube with Strainer for 16 - 55 Gallon Drums with 2" Bung and H.D.



Drum Not Included

Manual Rotary Pump for 55 Gallon Drums

SKU 462977
LIN1385 **179⁹⁹**

Hose and Drum Not Included

BONUS VALUE: \$39.99

5 Qt. Measuring Can
SKU 298486 | LING525
With Purchase of:
Manual Rotary Pump with Hose
SKU 265089 | LIN1385H
VDP ORDERS ONLY
Offer Good Through March 31, 2019
While Supplies Last

Manual Rotary Fuel Pump with Hose for 55 Gallon Drums

SKU 265088
LIN1387 **279⁹⁹**

- 3 Vane Manual Rotary Pump for Most Fluid Types Including Gasoline, Diesel, Kerosene, Coolant, Non-Corrosive Materials, Medium Viscosity Petroleum Based Fluids, Hydraulic Oils and ATF



Drum Not Included

Transfer Pumps

Multi-Purpose Drill Powered Pump

SKU OUTSIDE BUY/EPO
24503 **19⁹⁹**

- Works with a Corded or Cordless Drill to Transfer the Following Liquids: Fresh Water, Sea Water, Organic Solvents, Motor Oil, Heating Oil, Insecticides and Liquid Fertilizers



Available via Outside Buy/EPO,
Call 1-877-298-6651 for Ordering Instructions

Battery-Operated Liquid Transfer Pump

SKU 471071
25712 **11⁹⁹**

- Move Liquids Safely and Easily with This Convenient Handheld Pump
- Pumps Gas, Water, Oil and Other Non-Corrosive Liquids
- Pumps Up to 6 Quarts of Liquid per Minute



Multi-Use Fluid Transfer Pump

SKU 094647
25713 **7⁹⁹**

- Intake and Discharge Transfer System
- Pumps Air into Inflatables
- Includes: (2) 50" (127 cm) Long Hoses



Fluid Transfer Pump

SKU OUTSIDE BUY/EPO
OEM25717 **7⁹⁹**

- Fits All Standard Gallon Bottles
- Quick Fit Nozzle

Available via Outside Buy/EPO,
Call 1-877-298-6651
for Ordering Instructions



Fuel Caddies

25 Gallon Fuel Chief Steel Gas Caddy

SKU 360585
DOWFC25GC **599⁹⁹**

- 25-Gallon Tank is Constructed of 14" Gauge Steel for Use with Unleaded Gasoline, Kerosene, Ethanol E85, Diesel, and Bio-Diesel Fuels



BONUS VALUE: \$189.99

Fuel Tank Adapter

SKU 222503 | DOWJDI-FTA7

With Purchase of:
25 Gallon Fuel Chief Steel Gas Caddy
SKU 360585 | DOWFC25GC



Offer Good Through
March 31, 2019
While Supplies Last

Filter Crusher

Industrial 10-Ton Oil Filter/Can Crusher

SKU 990215
RANRP20FC **1,499⁹⁹**

- Reduces Used Oil Filters to 1/4 of the Original Size
- 20,000 Lbs. Crushing Power
- 100% Air Operated



INCLUDES STAND

Lincoln Powerluber

12V Powerluber
SKU 219686
LIN1242 **199⁹⁹**

- 6,000 PSI with Overload Protection
- High Capacity Ni-Cad 12 Volt Battery
- 30" Flex Hose, Spring Guard and Coupler
- Plated Steel Barrel

Mobile Charger 12-24V

SKU 517572
LIN1815A **59⁹⁹**



18V Cordless Grease Gun - 2 Batteries

SKU 988881
LIN1844 **399⁹⁹**

- High Output 18V Motor Delivers Excellent Performance in Heavy-duty Applications
- New 18V Motor and Battery Technologies Combine to Provide Outstanding Run Time
- Same as LIN1842 Kit but with 2 Batteries to Reduce Downtime



Industrial Fully Auto Pneumatic Grease Gun

SKU 445386
LIN1162 **109⁹⁹**

- Fully Automatic, Continuous Operation
- Accessible Check Valve Assembly
- 30" High-Pressure Hose with Coupler and Attachment Clip
- Pump Ratio: 40:1 at 150 PSI
- Max. Grease Pressure: 6,000 PSI Air Pressure Range: 40-150 PSI



BONUS VALUE: \$89.99

12V Battery
SKU 219699 | LIN1201
With Purchase of:
12V PowerLuber
SKU 219686 | LIN1242
VDP ORDERS ONLY
Offer Good Through March 31, 2019 - While Supplies Last



18V 1 Hour Fast Charger

SKU OUTSIDE BUY/EPO
LIN1855A **79⁹⁹**

Available via Outside Buy/EPO,
Call 1-877-298-6651 for Ordering Instructions

18V Battery

SKU 970540
LIN1801 **89⁹⁹**

BONUS VALUE: \$89.99

18 Volt Battery
SKU 970540 | LIN1801
With Purchase of:
Cordless Grease Gun - 2 Batteries
SKU 988881 | LIN1844
VDP ORDERS ONLY
Offer Good Through March 31, 2019 - While Supplies Last



12V Li-ion PowerLuber Kit

SKU 605324
LIN1264 **219⁹⁹**

- Lithium-ion Battery for Maximum Power and Efficiency
- Provides Effortless, Uniform Lubricant Delivery at up to 8,000 PSI
- Built-in LED Illuminates Dimly Lit Areas
- 30" Grease Hose and Integrated Hose Holder



18V Li-ion PowerLuber

- 2 Speed Design Delivers Outstanding Flow and Pressure
- LCD Flow Meter Displays Grease Output, Cartridge Level and Charge Level
- LED Lights up Fittings when Under Equipment or in Shaded Areas
- Dual Motor Protection Includes Self-resetting Thermocouple
- 18V High-amperage Li-ion Battery Provides Outstanding Run Time
- 36" Hose with Spring Guard



PowerLuber, 2 Batteries

SKU 517581
LIN1864 **499⁹⁹**

Grease Gun Kit, 1 Battery

SKU 517579
LIN1862 **449⁹⁹**

18V Li-ion

SKU OUTSIDE BUY/EPO
LIN1861 **172⁹⁹**

Available via Outside Buy/EPO,
Call 1-877-298-6651 for Ordering Instructions

20V Li-ion PowerLuber Kit

SKU 751676
LIN1884 **389⁹⁹**

- Delivers Grease at Up to 10,000 PSI
- Built-in LED Illuminates the Work Area
- Multi-Function LCD Display
- Includes: Grease Gun, 2 Batteries, Charger and Case, 36 In. Flex Hose



20V Li-ion Battery

SKU 751659
LIN1871 **94⁹⁹**

20V 12/24 Volt DC Mobile Charger

SKU 751663
LIN1875A **59⁹⁹**

Mobile Charger 12-24V

SKU 517572
LIN1815A **59⁹⁹**

Grease Guns

Economy Grease Gun
SKU OUTSIDE BUY/EPO
OEM25748 **12⁹⁹**

- Develops Up to 10,000 PSI
- Uses Standard 14 Oz. Grease Cartridge
- 4 In. Extension with Coupler



Available via
Outside Buy/EPO,
Call 1-877-298-6651 for
Ordering Instructions

OEM TOOLS

Air Grease Gun

SKU 125116
25818 **35⁹⁹**

- Operating Pressure: 30 - 150 PSI
- Delivery Pressure: 1,200 - 6,000 PSI
- Air Consumption: 4.0 CFM



LINCOLN

Heavy-Duty Dual Pressure Lever Grease Gun

SKU 517571
LIN1013 **49⁹⁹**

- High or Low Pressure for Light- or Heavy-duty Greasing Action
- Full Pressure on Short Strokes for Heavy Greasing in Tight Places; Develops Full Pressure with Just 1/4" Stroke
- Extension Swivels 360° for Hard-to-reach Fittings
- Plated Barrel, Head and Handle
- Handy Three-way Loading: Cartridge, Filler Pump or Bulk



LINCOLN

Extra Heavy Duty Pistol Grip

SKU 445385
LIN1134 **55⁹⁹**

- 18" Whip Hose
- Includes Rigid Pipe
- Jam Proof Handle
- Variable Stroke Design
- 7,500 PSI
- Filler Nipple/Bleeder Valve



LINCOLN

Professional Lever Grease Gun

SKU 522902
LIN1142 **37⁹⁹**

- 3 Way Loading: By Cartridge, Bulk Load and Suction Load
- Jam Proof Toggle Mechanism
- Develops 10,000 PSI Pressure
- Uses Common 14-1/2 Oz. Cartridges



Professional Lever Grease Gun with 18" Whip Hose and Coupler

SKU 522903
LIN1147 **44⁹⁹**

Mini Grease Guns

Mini Professional Grease Gun

SKU 417709
25725 **9⁹⁹**

- 12" Flex Hose
- Uses Standard 3 Oz. (85.05G) Grease Cartridge



Mini Grease Gun

SKU 081336
25727 **10⁹⁹**

- Ideal for Accessing Hard-to-Reach Spaces
- Includes (1) 3 Oz. Standard Cartridge of Yellow Lithium Grease



3 Oz. Lever-Action Grease Gun

SKU 526489
LING103 **21⁹⁹**

- Uses 3 Oz. (85 g) Cartridge or Can be Hand Packed or Bulk Filled
- Lever-action Design Produces 6000 PSI
- Conveniently Stores in Tool Box or Tray



Grease Gun Accessories

Hand Operated Grease Gun Hose

- Maximum Working Pressure 3,000 PSI
- 1/8 In. NPT Male Threads
- Hand Operated Guns Only

12"

SKU OUTSIDE BUY/EPO
OEM25708 **4⁹⁹**

Available via Outside Buy/EPO,
Call 1-877-298-6651 for Ordering Instructions

18"

SKU 293489
25709 **4⁹⁹**



Needle Nozzle

SKU 141690
25718 **5⁹⁹**

Grease Injector Needle

SKU OUTSIDE BUY/EPO
OEM25719 **5⁹⁹**

Available via Outside Buy/EPO,
Call 1-877-298-6651 for Ordering Instructions



7 Piece Grease Fitting Adapter Kit

SKU 978118
25711 **19⁹⁹**

- Includes: Press-On 90° Lube Tool, Straight Extension, 300 mm Hose Extension, Slide-On 90° Coupler, Rubber Tip Nozzle, Needle Nozzle, 360° Coupler



70 Piece Grease Fitting Assortment

SKU OUTSIDE BUY/EPO
25752 **12⁹⁹**

- 70 Assorted Grease Fittings in Six Popular Sizes. Sturdy, Easy to Handle Dispenser Box has Labeled and Illustrated Compartments

Available via Outside Buy/EPO,
Call 1-877-298-6651 for
Ordering Instructions



Lincoln Grease Pumps

Manual Gear Lube Dispenser

SKU 174166
LIN1293 **89⁹⁹**

- 5 Ft. Hose, 13" Pump Tube
- Fits 25 - 50 Lbs., 5 Gallon Container
- Delivers 1 Oz. per Stroke



Grease Pump Package

SKU 110259
LING917 **959⁹⁹**

- Portable 50:1, Air Operated, Double-Acting Grease Pump Ensures High-Output Grease Delivery
- Lube Fitting with Control Valve and Universal Swivel
- Standard Follower Wipes 120 Lbs. Drum Sides Clean and Keeps the Pump Primed



Bearing Packers

Universal Bearing Packer

SKU 082945
OEM25070 **8⁹⁹**

- 4-3/8" Cone Diameter
- Forces Out the Old Grease and Evenly Injects Fresh Grease



Bearing Packer

SKU 900799
25073 **19⁹⁹**

- Works on Bearings Up to 3-1/2" O.D.
- Forces Old Grease Out and New Grease In



AIR CONDITIONING

**WE OFFER
A FULL LINE
FROM:**

ROBINAIR

MAHLE



Mastercool
"World Class Quality"

cps

Recovery Machines



Mastercool
"World Class Quality"

COMMANDER3000 R134a and Hybrid R/R/R Machine

SKU 471054 MSC3000 **3,999⁹⁹**

- R134a and Hybrid
- 8" Command Center
- Wi-Fi Capable
- Vacuum Leak Test
- On-Board Instruction Manual and Refrigerant Database
- Built-in Tank Heater
- 6 CFM Vacuum Pump
- Dust Cover
- Hose Flushing
- Does Not Include Automatic Oil Injection



1 Year Warranty

COMMANDER1000 Semi-Automatic R134a R/R/R Machine

SKU 471051 MSC1000 **2,999⁹⁹**

COMMANDER2000 Fully Automatic R134a R/R/R Machine

SKU 471040 MSC2000 **3,799⁹⁹**



Mastercool
"World Class Quality"

COMMANDER4000 R1234YF Recovery, Recycle, and Recharge Machine with Identifier

SKU 471061 MSC4000 **5,799⁹⁹**

- R1234f and Hybrid
- 8" Command Center
- Wi-Fi Capable
- On-Board Instruction Manual and Refrigerant Database
- Built-in Tank Heater
- Vacuum Leak Test
- 6 CFM Vacuum Pump
- Built-in Refrigerant Identifier
- Hose Flushing
- Dust Cover Included
- Does Not Include Automatic Oil Injection



1 Year Warranty

Replacement Filters For Recovery/Recharge Machines

SKU 199675 MSCCOM2FLTRPK **159⁹⁹**



- Replacement Filter Pack Kit for the Commander 1000, 2000 and 3000

SKU 199681 MSCCOM1FLTRPK **139⁹⁹**



- Replacement Filter for Commander 4000 and 4000X

Dual Gas Recovery/Recycle/Recharge Machine with Printer

SKU 850572 CPSFX3030 **7,669⁹⁹**

- Convertible Between R134a and R1234yf
- Built-in Refrigerant Identifier
- Vehicle Refrigerant Capacity Database Included
- Includes 2 Tanks and 2 Sets of Hoses
- 1-2-5 Warranty



Hybrid Ready

Set-Up and Training Included!

FX Recovery Machine Filter Kit

SKU OUTSIDE BUY/EPO CPSFX3030X1 **119⁹⁹**

- For Use with CPS FX Series A/C Recovery Machines

Available via Outside Buy/EPO, Call 1-877-298-6651 for Ordering Instructions

Premier R134a Refrigerant Recovery, Recycling and Recharging Machine

SKU OUTSIDE BUY/EPO ROB34788NI **3,889⁹⁹**

- Fully Automatic Function
- Automatic Oil Drain
- Oil Inject: Auto Oil Injection
- Vacuum Leak Testing
- Refrigerant Charging

WARRANTY: 2 Year Limited Warranty

Premier R134a Refrigerant Recovery, Recycling and Recharging Machine for Hybrid and Non-Hybrid

SKU OUTSIDE BUY/EPO ROB34788NI-H **3,889⁹⁹**

- Does Not Feature Auto Oil Injection

Available via Outside Buy/EPO, Call 1-877-298-6651 for Ordering Instructions

ROBINAIR



AC1234-4 1234YF Recover, Recycle, Recharge Machine

SKU OUTSIDE BUY/EPO ROBAC1234-4 **5,749⁹⁹**

- Fully Automatic Operation — Program for Service, Walk Away and Return When Complete
- Programmable Vacuum Operation
- System Leak Test to Identify Gross Leaks on a System
- Automatic Oil Drain & Air Purge
- Integrated Refrigerant Identifier (Meets SAE J2927)
- Automatic Internal Tank Refill

WARRANTY: 2 Year Limited Warranty

1234YF Recover, Recycle, Recharge Machine

SKU OUTSIDE BUY/EPO ROBAC1234-6 **6,499⁹⁹**

Available via Outside Buy/EPO, Call 1-877-298-6651 for Ordering Instructions

ROBINAIR



Hybrid Ready

Set-Up and Training Included!

ACX-2120H Hybrid Ready R134a A/C Recovery Machine

SKU OUTSIDE BUY/EPO MSSACX2120H **3,599⁹⁹**

- Fully Automatic
- Meets SAE J2788 Purity, Safety and Performance Standards
- Pump Functionality That Performs a Self-Cleaning Process (Reducing Maintenance)
- Hybrid Function Designed for Servicing All Passenger Cars and Hybrid Vehicles
- High Performance Vacuum Pump -- 4 Minutes Faster Service Time Than a Double-Capacity Pump
- New Hinged Service Door Simplifies Unit Service
- Tool Tray for Easy Storage and Organization of Tools
- Automatic Air Purge Maximizes Efficiency, Speed and Ease of Control Process
- Remote Technician Diagnostics Allows Technician to Connect Remotely
- Lifetime Phone Support Coverage and a 2 Year Standard Warranty



A/C Recovery Filter Kit
SKU 207349 MSS268077600 **99⁹⁹**

Set-Up and Training Included!
Revised Software and Filter Upgrade

Available via Outside Buy/EPO, Call 1-877-298-6651 for Ordering Instructions

ACX-2280 A/C Recovery Machine for 1234YF

SKU OUTSIDE BUY/EPO MSSACX2280 **6,949⁹⁹**

- Fully Automatic
- Meets SAE J2788 Purity, Safety and Performance Standards
- 7" Capacitive Touch LCD Display
- Remote Control via Smartphone/Tablet App (iOS and Android)
- Permanent, Wireless, Automatic Software Updates
- Oil System Management Provides Automatic Weighing of Recovered Oil
- Tool Tray for Easy Storage and Organization of Tools
- Remote Technician Diagnostics Allows Technician to Connect Remotely
- Enterprise Data Management/Reporting
- Lifetime Phone Support Coverage and a 2 Year Standard Warranty



Hybrid Ready

Set-Up and Training Included!

A/C Recovery Filter Kit

SKU 470141 MSS268069600 **134⁹⁹**

Available via Outside Buy/EPO, Call 1-877-298-6651 for Ordering Instructions

Portable Recovery Systems



Mastercool
"World Class Quality"

R1234yf Twin Turbo Complete Recovery Machine

SKU 034469 MSC69360-YF **1,299⁹⁹**

- Revolutionary Double Piston Oil-Less Compressor
- Largest Volume Recovery Rate on the Market
- Includes: 30 Lbs. DOT Tank, Sight-Glass, R1234yf Low Side Coupler, Oil Drain Bottle and R1234yf Blue and Yellow Hoses



Mastercool
"World Class Quality"

Portable R134a Recovery System

SKU 290024 MSC69100 **1,369⁹⁹**

- High Performance Oil-Less Compressor
- Includes an Oil Separator and Filter Dryer to Clean Refrigerant During Recovery
- Recovers All Refrigerants, 30 Lbs. DOT Recovery Tank Included



Portable A/C Recovery Machine

SKU 504026 CPSTRA21 **1,499⁹⁹**

- SAEJ2810 Approved, Fastest Recovery Recycle Machine in the Industry
- Oil Separator and Filter Includes 30 Lb. Tank and Manifold Set with 60' Hoses and Manual Couplers





FREE OVERNIGHT SHIPPING
WITH MOST ORDERS
SEE PAGE 3 FOR DETAILS

Vacuum Pump Kits

A/C Service Set with Air Vacuum Pump - R134a

SKU 850564
68991 **99⁹⁹**

- Complete Kit for Diagnosing and Charging R134a A/C Systems
- Includes: Air Vacuum Pump with 1/2" ACME R134a and R12 Connectors, Brass Manifold Gauge Set with 60" Hoses and Snap Style Couplers, Brass Can Tap Valve and Large Diameter Dual Scale Thermometer

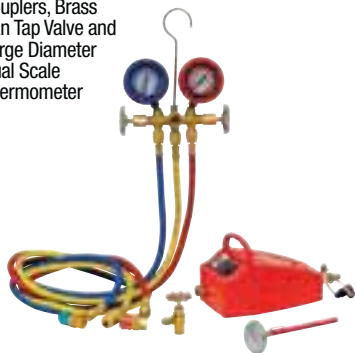

A/C Starter Kit - R134a

SKU 695127
68987 **179⁹⁹**

- 1.8 CFM, 100 Micron Single Stage Vacuum Provides Fast, Thorough Evacuation and Provides Powerful, Quiet, High Vacuum Capability
- Ensures Moisture Removal
- Kit Includes: Professional Quality Extruded Aluminum Manifold with Sight Glass, 72" Hoses, Manual Couplers and Easy-to-Read Spring Dampened Gauges to Reduce Flutter
- R134a Can Tap Connects to Any ACME Threaded R134a Can

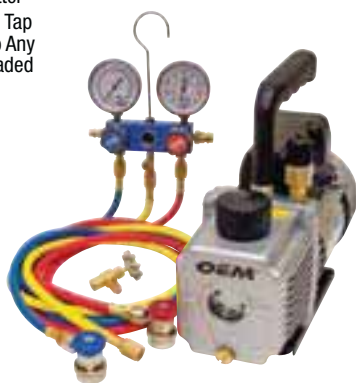

3 Piece High Performance A/C Kit

SKU 626121
68989 **249⁹⁹**

- 6 CFM, 75 Micron Single Stage Vacuum Provides Fast, Thorough Evacuation and Provides Powerful, Quiet, High Vacuum Capability, Ensuring Moisture Removal and Reducing Evacuation Time
- Kit Includes: Professional Quality Extruded Aluminum Manifold with Sight Glass, 72" Hoses, Manual Couplers and Easy-to-Read Spring Dampened Gauges to Reduce Flutter
- 3-in-1 Can Tap Fits 1 Lb. Cans of R134a, R12 and 2" Oil Charge Cans and Includes 1/2" ACME Male and 1/4" FL - Male Ports

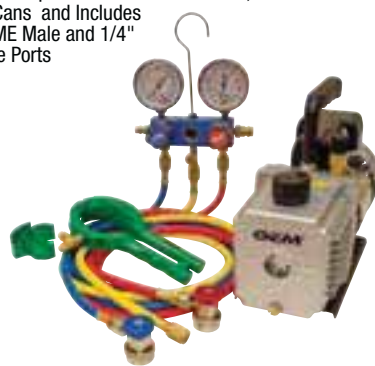

A/C Professional Set - R134a

OEM TOOLS™

SKU 695129
68988 **299⁹⁹**

- 4 CFM, 75 Micron Single Stage Vacuum Provides Fast, Thorough Evacuation and Provides Powerful, Quiet, High Vacuum Capability, Ensuring Moisture Removal and Reducing Evacuation Time
- Kit Includes: Professional Quality Extruded Aluminum Manifold with Sight Glass, 72" Hoses, Manual Couplers and Easy-to-Read Spring Dampened Gauges to Reduce Flutter
- 3-in-1 Can Tap Fits 1 Lb. Cans of R134a, R12 and 2" Oil Charge Cans and Includes 1/2" ACME Male and 1/4" FL - Male Ports
- AC Refrigerant Leak Detector is Sensitive to 0.1 Oz./Year and Responds to All Halogenated Refrigerants



Vacuum Pumps

OEM TOOLS™

6 CFM Single Stage Vacuum Pump

SKU 466306
24502 **159⁹⁹**

- 1/3 HP, 110V Motor
- 75 Microns
- Internal High Volume Cooling Fan for Extended Use
- Inlet Ports: 1/2" ACME - 1/4" Flare
- Oil Capacity: 330 mL, Included



1.8 CFM Single Stage Vacuum Pump

SKU 466312
24500 **124⁹⁹**

- 1/4 HP, 110V Motor
- 100 Microns
- Internal High Volume Cooling Fan for Extended Use
- Inlet Ports: 1/2" ACME - 1/4" Flare
- Oil Capacity: 200 mL, Included



Vacuum Pump Oil (8 Oz.)

OEM TOOLS™

SKU 363429
24399 **9⁹⁹**

- Increases Life Span of the Pump
- Performance of Your Pump Depends on Regular Service and the Quality and Purity of the Vacuum Pump Oil That You Use
- Compatible for Use in Pumps Made By Most Manufacturers



Air-Operated Vacuum Pump

SKU 544730
24533 **29⁹⁹**

- Includes 1/2" ACME (R134a) and R12 Connectors
- Air Pressure Range: 75 - 180 PSI
- Air Consumption: 4.2 CFM @ 90 PSI
- Vacuum Capacity: 28.3" of Mercury @ 90 PSI



Premium Vacuum Pump Oil 1 Quart Bottle

SKU 517580
CPSVPOQ12 **12⁹⁹**

- Compatible with Most Pumps
- Increases Life Span of the Pump
- Performance of Your Pump Depends on Regular Service and the Quality and Purity of the Vacuum Pump Oil That You Use



Manifold Gauges

OEM TOOLS™



R134a Brass Manifold Gauges Set

SKU 752520
24563 **64⁹⁹**

- High Quality Brass Body with Sight Glass
- Large 2-1/2" Gauges are Easy to Calibrate and Have a High Impact Lexan Lens
- 60" 3,000 PSI Burst, 600 PSI Working Pressure Hoses
- Snap Style Quick Couplers

OEM TOOLS™



R134a Manifold Gauge Set with Sight Glass

SKU 466319
24527 **99⁹⁹**

- Easy-to-Read Spring Dampened Gauges to Reduce Flutter
- 72" Hoses with Manual Couplers

OEM TOOLS™



R1234YF Manifold Gauge Set

SKU 752518
24559 **149⁹⁹**

- 3" Easy-to-Read Gauges with Temperature Chart
- 72" Hoses
- High Quality 6-Ball Manual Couplers

Mastercool®
"World Class Quality"



R134a Aluminum Manifold Kit with Dye Injector

SKU 290023
MSC89660UV **149⁹⁹**

- Includes: R134a Aluminum Manifold, 60" Hoses, Standard Couplers and 10 Application Mini Dye Injector

Mastercool®
"World Class Quality"



R134a Aluminum Manifold Kit with Dye Injector

SKU 290022
MSC89661UV **169⁹⁹**

- Includes: R134a Aluminum Manifold, 60" Hoses, Manual Couplers and 10 Application Mini Dye Injector

A/C Recovery Machine Accessories

CALL AZTOOL AT 877-AZTOOL1 FOR ADDITIONAL FILTERS & MAINTENANCE KITS

34412-C Vehicle A/C Refrigerant Database 2018

SKU OUTSIDE BUY/EPO
ROB34412-C **249⁹⁹**

- R-134a Refrigerant Vehicle A/C System Charge Capacities
- Oil Capacities for Various Components within the Vehicle's A/C System
- Covers Most Makes and Models Between 1997-2018 Using R-134a Refrigerant
- For the Robinair 34288NI, 34788NI, 34788NI-H and 34988NI A/C Recovery Machines



R134A Vehicle A/C Refrigerant Database 2018

SKU OUTSIDE BUY/EPO
ROB34411-H **249⁹⁹**

Available via Outside Buy/EPO, Call 1-877-298-6651 for Ordering Instructions

A/C Capabilities Database 2018

SKU OUTSIDE BUY/EPO
ROB34413-A **249⁹⁹**

Vinyl Dust Cover for A/C Recovery Machine

SKU 751574
ROB17499 **99⁹⁹**

- Protect Your Investment with a Heavy Duty Vinyl Dust Cover
- Fits AC1234-6, 34788NI, 34788NI-H Models



A/C Recovery Machine Maintenance Kit

ROBINAIR™

SKU 752703
ROB13172 **74⁹⁹**

- Contains: (1) Quick Change Filter-Drier to Be Used on Both R-12 and R-134a Stations and (1) 16 Ounce Bottle of Our Premium High Vacuum Pump Oil
- For Models Using 34724 Filter-Drier: 17700A, 17700-2K, 34700, 34700-2K, 34800, 34800-2K, 34900 Series



A/C Recycle Guard Accessories

DARG Hose Assembly Kit - Hoses with Quick Couplers, Service Adaptors

SKU 504092
AIR75100 **124⁹⁹**

- Includes 72" High Side and Low Side Charging Hoses with Quick Couplers and High and Low Side Quick Connect Service Adaptor



Recycle Guard™ for R134a - 1/2" ACME Fittings with 36" Service Hose

SKU 504082
AIR72101 **254⁹⁹**

- Can Be Used for R134a and R1234yf
- Includes 36" Service Hose
- Protect Your Recovery Equipment from Debris, Sealant, Dye, Excess Lubricant and Other Contaminants
- Works With All A/C Service Equipment



Recycle Guard™ for 1/4" SAE Flare with 36" Service Hose

SKU 504083
AIR72102 **254⁹⁹**

- Can Be Used for R134a and R1234yf
- Includes 36" Service Hose
- Protect Your Recovery Equipment from Debris, Sealant, Dye, Excess Lubricant and Other Contaminants
- Works with All A/C Service Equipment



Dual Automatic Recycle Guard™ for R134a with (2) 36" Service Hoses

AIRSEPT™

SKU 504091
AIR75000 **389⁹⁹**

- Can Be Used for R134a and R1234yf
- High and Low Side Protection for A/C Service Equipment from Debris, Sealant, Dye, Excess Lubricant and Other Contaminants
- No Technician Input Required - Switches Automatically from Recover to Recharge
- Traps Metal Shavings, Desiccant Particles and Other Harmful Debris
- Includes (2) 36" Service Hoses



AIR CONDITIONING

Manifold Gauge Repair

Replacement Gauge Low Side for A/C Manifold

SKU 481709 **18⁹⁹**
24531

- Low Compound Gauge for OEMTOOLS™ and Other Brands of A/C Manifold Sets Used to Service A/C Systems on Cars
- Reads 0-120 PSI and 0-30" Hg
- 1/8" NPTF Male Threads



Replacement Gauge High Side for A/C Manifold

SKU 481705 **14⁹⁹**
24530

- Replacement High Side Gauge Fits OEMTOOLS™ and Other Brands of A/C Manifolds Used to Service A/C Systems on Cars
- 1/8" NPTF Male Threads
- Reads 0-500 PSI Hose



1/4" Hose Set 72"

SKU 752515 **39⁹⁹**
24557

- 72", 1/4" SAE 3 Hose Set Color Coded: Red, Yellow and Blue



R134a Hose Set 72"

SKU 752516 **39⁹⁹**
24558

- 72" R134a 3 Hose Set Color Coded: Red, Yellow and Blue



96" R134a Red Hose

SKU 489152 **34⁹⁹**
MSC84963

- 1/2" ACME-F and 14 mm-M Auto A/C Fittings - 96"



96" R134a Blue Hose

SKU 489151 **34⁹⁹**
MSC84961

- 1/2" ACME-F and 14 mm-M Auto A/C Fittings - 96"



1/4" Hose Set SAE 60"

SKU 347260 **29⁹⁹**
24390

- Maximum Working / Burst Pressure 300PSI / 3000PSI
- Solid Brass Fittings
- 60" Long



1/4" SAE Hose Set

SKU 512962 **59⁹⁹**
27230

- High Pressure Hose Length: 6'
- Low Pressure Hose Length: 6'
- Freon Hose Length: 8'



A/C Couplers

R134a Refrigerant Tank Adapter

SKU 850565 **17⁹⁹**
24554

- Male Low-Side R134a to Female 1/2" ACME
- Attaches to Virgin Tank and Low-Side Service Coupler



R134a High Side Manual Coupler

SKU 347267 **34⁹⁹**
24395

- All Metal Construction for Extra Durability
- 6 Ball Coupler for Secure Grip
- Includes an Adapter for Use with R12 Hoses



R134a Low Side Manual Coupler

SKU 347266 **29⁹⁹**
24394

- All Metal Construction for Extra Durability
- 6 Ball Coupler for Secure Grip
- Includes an Adapter for Use with R12 Hoses



R134a High and Low Side Coupler Set

SKU 362980 **49⁹⁹**
24396

- Change Your Old R12 Manifold Set to R134a with This Set of Manual Couplers
- All Metal Construction for Extra Durability
- 6 Ball Coupler for Secure Grip
- Includes Adapter for Use with R12 Hoses



R134a Extra Long Coupler

SKU 752517 **49⁹⁹**
24556

- Used on BMW E60 (2003 - 2009 5 Series) and Some Volvo Models
- Allows for A/C Service with No Radiator Removal



Conversion Coupler Set R134a to HFO-1234YF

SKU 752527 **69⁹⁹**
24561

- HFO-1234YF Manual Couplers with 14 mm Female Threads to Convert R134a Manifold and Hoses to HFO-1234YF
- Includes: Tank Adapter, 1/2" ACME Right Hand to 1/2" ACME Left Hand Adapter



A/C Flush

Total A/C Quick Flush Kit

SKU 695646 **49⁹⁹**
MSC91051

- Includes: 17 Oz. Pressurized A/C Flush, Hose and Rubber Tipped Blow Gun with Thumb Control
- Pressurized to 150 PSI
- Non-Toxic
- Self-Evaporating
- Single Use Disposable Cans



A/C Quick Flush 17 Oz. Replacement

SKU 695647 **24⁹⁹**
MSC91050

- Includes: 17 Oz. Replacement A/C Flush Can



A/C Flush 32 Oz. Bottle

SKU 695650 **19⁹⁹**
MSC91049-32

- 6 Pack
- SKU 695652 **79⁹⁹**
MSC91049-32-6



A/C Flush Solvent (1 Gallon)

SKU 695653 **44⁹⁹**
MSC91049-128

- Non-Toxic, Quick Evaporating A/C Flush
- Effectively Removes Debris and Sludge from A/C Components
- Solvent-Based, Leaves No Residue
- Professional Use Only
- Flush Any A/C System



- Case of 4
- SKU 695654 **159⁹⁹**
MSC910491284

A/C Flush Machine

SKU 217370 **989⁹⁹**
CPSAFM100

- Air Operated
- 8 Foot Hoses to Reach Any System
- Forward or Reverse Flush without Changing Hoses
- 2-1/2 Gallon Capacity Tank for Use on Cars and Buses
- Universal Couplers Allows Connection to Virtually All Types of Connections
- Clear Filter Bowl Allows You to See What is Coming Out of the System with a Cleanable Filter



A/C System Flush Kit

SKU 466308 **59⁹⁹**
24515

- Use with MSC91049 A/C Flush Solvents
- Includes: Canister, Hose, Blow Gun, Rubber Tip and Cylinder Cap



MASTERCLEANSE A/C Flush Machine

SKU 034468 **699⁹⁹**
MSC69900

- Designed to Flush All HVAC/R and Automotive Systems
- Pump Power: 0.4 HP; Flow Rate: 4 Gal/Min.
- Stainless Steel Ball Valve Controls
- 1/4" SAE Connection
- Pump Equipped with Mechanical Seal and PTFE Gasket



Can Taps

R134a Can Tap Valve

SKU 466315 **9⁹⁹**
24524

- Connects ACME Threaded R134a Can to Yellow Manifold Gauge Charging Hose



Refrigerant and Oil Charge Can Tap

SKU 466313 **18⁹⁹**
24523

- Fits 1 Lb. Cans of R134a, R12 and 2" Oil Charge Cans
- Plier Type Grip with Positive Lock
- Includes: 1/2" ACME Male and 1/4" FL Male Ports with Safety Valve



R1234yf 1/2" ACME-LH Thread Piercing Can Tap Valve

SKU 034453 **14⁹⁹**
MSC85510-YF

- For Use with R1234yf Pierce-Designed Cans
- Gasket Assures Leak-Proof Operation
- Works with SAE J2844 Fittings



R1234yf 1/2" ACME-LH Thread Self-Sealing Design Can Tap Valve

SKU 034448 **16⁹⁹**
MSC85512-YF

- For Use with R1234yf Self-Sealing/Reusable Designed Cans
- Gasket Assures Leak-Proof Operation
- Works with SAE J2844 Fittings



Valve Tools

No Gas Loss A/C Valve Core Remover/Installer

SKU 466321 **39⁹⁹**
24529

- Remove and Install Standard R134a Valve Cores without the Loss of Refrigerant
- Built-in Ball Valve Retains Charge and Allows Access to A/C System
- For 13 mm and 16 mm High and Low Service Ports



Recharge Kits

R134a DIY Refrigerant Recharge Kit

SKU 466316 **19⁹⁹**
24525

- Will Service Most R134a Systems
- Includes High Pressure Hose and Quick Disconnect Coupler



R1234yf Self-Sealing Design Recharge Kit

SKU 034423 **32⁹⁹**
MSC85535-YF

- Includes: (85512-YF) R1234yf Can Tap Valve, (67534) R1234yf Low Side Quick Coupler and (83181) R1234yf 18" Blue Hose
- R1234yf Low Side Quick Coupler Threading: 12 mm-F x 14 mm



R1234yf Recharge Kit - Piercing Design

SKU 034433 **29⁹⁹**
MSC85525-YF

- Includes: (85510-YF) R1234yf Can Tap Valve, (67534) R1234yf Low Side Quick Coupler, and (83181) R1234yf 18" Blue Hose
- R1234yf Low Side Quick Coupler Threading: 12 mm-F x 14 mm



Leak Detection Lights

UV Pen Light

SKU 695128 **19⁹⁹**
 24610

- Pen Style Ultraviolet Light
- Lightweight, Aluminum Casing
- Convenient Pocket Clip
- Maximum Continuous Run Time is 4.5 Hours



Mini UV Flashlight - 12 LED

SKU 300782 **34⁹⁹**
 MSC53512-UV

- 25,000 Hour Bulb Life
- 3 AAA Batteries / Operates for 22 Hours Under Normal Work Conditions
- Comparable to 50 Watt Illumination
- UV Goggles Included



Mechanic's 500 Lumen Rechargeable Flashlight and 450 Lumen Ultra Slim Wand with UV Inspection

SKU 344835 **79⁹⁹**
 24607

- 500 Lumen Flashlight Will Cast a 170 Meter Beam
- Ultra Slim 450 Lumen Inspection Light Casts a 30 Meter Beam
- 3 Powerful, UV LED Lights on Inspection Light Detect Leaks Quickly and Easily
- Detachable 180 Degree Swivel Hook with Magnets
- Battery Lasts 3.5 Hours at 100% and Fully Charges in 5 Hours
- 5 Light Modes
- Comes with (1) USB Charging Cord, AC Adapter, (1) 18650 Rechargeable Battery, and a 180 Degree Swivel Hook

1 Handle/ 3 Lights



Compact UV Flashlight - 17 LED

SKU 300783 **54⁹⁹**
 MSC53517-UV

- 25,000 Hour Bulb Life
- 3 AAA Batteries / Operates for 22 Hours Under Normal Work Conditions
- Comparable to 75 Watt Illumination
- UV Goggles Included



USB Rechargeable UV Light with Glasses

SKU 626122 **49⁹⁹**
 EXPE93-E02

- 1W Bulb That Casts a Beam Up to 5 Meters
- 0.8 Lumens
- 3 Light Modes: 25%, 50% and 100%
- Run Time: 12 Hours
- USB Cord



INCLUDES:

- Battery
- USB Charging Cord
- Hook
- AC Adapter



① UV Light
 ② Slim Wand
 ③ Flashlight

500 LUMENS FLASHLIGHT
450 LUMENS SLIM WAND
MAX RUN TIME 3.5H

Leak Detection

Complete A/C and Fluid Leak Detection Starter Kit

SKU 291378 **79⁹⁹**
 TRATP8621

- 50 Watt 6 LED Lamp
- Syringe A/C Dye Injector
- 1 Oz. (30ml) Bottle of Dye-Lite® All-in-One™ Standard Dye for All Oil-Based Fluids
- 1 Oz. (30ml) Bottle of Dye-Lite® Coolant Dye
- 1 Oz. (30ml) Bottle of Fluoro-Lite® Universal / Ester A/C Dye
- 8 Oz. (237ml) Spray Bottle of GLO-AWAY™ Dye Cleaner
- R-134a Hose/ Coupler with Purge Fitting
- Fluorescence-Enhancing Glasses and Rugged Carrying Case



A/C Refrigerant Leak Detector

SKU 466307 **74⁹⁹**
 24510 REG. \$79.99

- Detects All Types of Halogenated Refrigerants
- Sensitive to 0.1 Oz. /Yr.
- Single Color LED Display with 7 Level Leak Alarm
- Flexible Stainless Steel Probe to Reach Almost Any Space
- Includes Spare Sensor Tip

SAVE \$5



Offer Good Through March 31, 2019 While Supplies Last

Professional UV Leak Detection Kit with 12V/50W UV Light

SKU 290041 **84⁹⁹**
 MSC53351

- 12 Volt / 50 Watt UV Leak Detector
- 1 Oz. Coolant Dye, 1 Oz. Oil/ATF/Fuel Dye, Dye Remover
- Mini Dye Injector (10 Applications of Universal A/C Dye) Compatible with R134a and R12 Adapter
- UV Enhancing Safety Glasses
- 12 Service Labels



OPTI-PRO™ Leak Detection Kit

SKU 765000 **149⁹⁹**
 TRATP8617

- EZ-Ject™ A/C Dye Injector
- R-134A Hose/Coupler with Purge Fitting
- EZ-Ject™ Universal/Ester A/C Dye Cartridge for Servicing Up to 14 Vehicles
- 1 Oz. (30 ml) Bottle of Dye-Lite® All-In-One™ Dye for All Oil-Based Fluid System
- 1 oz (30 ml) Bottle of Dye-Lite® Coolant Dye
- Includes Fluorescence-Enhancing Glasses and Rugged Carrying Cases



OPTI-PRO™/EZ-Shot™ A/C Dye Injection Kit

SKU 568718 **159⁹⁹**
 TRATP8616

- Cordless, Economical, Violet Light LED Leak Detection Flashlight
- EZ-Shot A/C Dye Injection Gun
- 8 Oz. (237 ml) BigEZ™ Universal/Ester A/C Dye Cartridge
- R-134a Hose/Coupler with Purge Fitting
- Includes Fluorescence-Enhancing Glasses and Rugged Carrying Case



Raptor Refrigerant Leak Detector

SKU 916550 **179⁹⁹**
 MSC56100

- Features (3) Sensitivity Levels and (5) Detection Levels
- Detects Leaks as Small as 1/10 Oz. per Year
- Detects All Refrigerants (CFC, HCFC, HFC)
- Flexible 16" Probe for Hard-to-Reach Areas



Inspector 2-in-1 Electronic/UV Leak Detector

SKU 916553 **199⁹⁹**
 MSC56200

- Pin-point Leaks as Small as 1/10 Oz. (3 gr) per Year
- Built-in Ultra-Bright UV Light at End of Probe – Allowing Easy Access into Tight Areas



IntellaSense II Refrigerant Leak Detector

SKU 695639 **219⁹⁹**
 MSC55900

- Detects: Combustible Gases, Hydrogen, Refrigerants (All CFCs, HCFCs and HFCs)
- Includes Leak Test Vial and Replacement Filters in a Blow Molded Box
- Meets and Exceeds SAE J2791 and J2913



Nitrogen Leak Test Kit

SKU 295560 **299⁹⁹**
 MSC53010

- T-Handle for Ease of Pressure Adjustment Kit
- Includes Leak Testing Gauges and Hoses



Thermal Camera

Thermal Imaging Camera

SKU 034435 **499⁹⁹**
 MSC52325

- Displays Thermal Image Overlays and Temperature – Designed for Automotive Applications
- Measurement Range: -4 to 662°F (-20 to 350°C)
- Accuracy: ±2% of Reading, or 4°F (2°C)
- Image Storage (SD Card): Stores Up to 25,000 Images, BMP Format
- 3.7V Li-Ion Rechargeable Battery Provides 3 Hours of Continuous Run Time



Thermometers

-58 to 300° F Digital Pocket Thermometer

SKU 447147 **12⁹⁹**
 24351

- Accurate Readings from -58 to 300° F (±2°) and from -50 to 150° C (±1°)
- Digital Display Will Rotate 180° and Move Up and Down for Easy Viewing
- Comes with 1.5V Battery



Non-Contact Infrared Thermometer

SKU 951642 **31⁹⁹**
 25245

- Temp Range: -58°F to 716°F, (50°C to 380°C)
- Distance to Spot Ratio of 12:1
- Laser Pointer



STORE STOCKED

Tube Assortment

Master Orifice Tube Assortment

SKU 851868 **24⁹⁹**
 24564

- Covers Most Vehicles That Require Air Conditioning Orifice Tubes
- Includes: Chrysler (Orange, Purple T-Top), Ford (Black, Blue, Brown, Green, Red), GM (Black T-Top, White, Yellow), Jeep (Green - White) and Volvo (Yellow)



Digital Scales

Digital Refrigerant Scale (240 Lb. Capacity)

SKU 752521 **149⁹⁹**
 24560

- High-Visibility .75" x 2.5" LCD Backlit Display
- (3) Units of Measure: kg/Oz./Lb.
- Automatic Shut-Off After 10 Minutes, Backlight Will Shut Off After 3 Minutes
- Fully Enclosed and Removable Metal Scale Platform Enables Use of Product In or Out of the Protective Case



Accu-Charge II™ / Electronic Charging Scale 240 Lb. Capacity

SKU 290029 **229⁹⁹**
 MSC98210A

- Programmable with Alarm



AIR CONDITIONING

Injectors

OEM TOOLS™ In-Line Dye and Oil Injector

- SKU 466322
24532 **49⁹⁹**
- Add Up to 2 Oz. of Oil or Dye to a System Under Vacuum or While Adding Refrigerant
 - 1/2" ACME Fittings to Fit Most R134a Systems
 - Use with TRATP38400601 Bottle Fluoro-Lite® Universal A/C Dye



OEM TOOLS™ R12 and R134a Hand Turn Dye Injector

- SKU 466320
24528 **69⁹⁹**
- Injects Dye or Oil into R12 or R134a Systems
 - Refillable, Capacity: 2 Oz.
 - Includes R134a Quick Coupler
 - Use with Pourable Dyes



TRACERLINE® EZ-Ject™ R-1234yf/PAG A/C Dye Injection Kit

- SKU 568721
TRATP9844 **84⁹⁹**
- Multi-Dose Cartridge Pre-filled with R-1234yf/PAG A/C Fluorescent Dye
 - Easily Overcomes System Pressure, Dye Can Be Injected While System is Off or Running
 - EZ-Ject R-1234yf/PAG A/C Dye Cartridge Services Up to 14 Vehicles



Mastercool® Refillable Universal Dye Injector for R1234YF

- SKU 764999
MSC53123-YF **119⁹⁹**
- Heavy Duty Aluminum Construction
 - Injects Dye or Oil into R1234YF Systems
 - Refillable, Any Dye or Oil Can Be Used
 - Easy Twist Injection System
 - Precise Injection Controlled



TRACERLINE® EZ-Shot™ Universal A/C Dye Injection Kit

- SKU 568723
TRATP9790 **149⁹⁹**
- EZ-Shot Quickly Introduces Dye into a Vehicle's A/C System
 - BigEZ™ Cartridges are Pre Filled with Co-Solvent Free A/C Dye, Certified to Meet SAE J2297 and Calibrated for Exact Dosing
 - BigEZ 8 Oz. Universal Dye Cartridge Services Up to 64 Vehicles



Identifier

Refrigerant Identifier for R134a

- SKU 295556
MSC69134-A **699⁹⁹**
- Avoid Potential Damage from Refrigerant Contamination
 - Automatically Provides Step-by-Step Indication of the Gas Sampling Process
 - Accuracy: Pass/Fail – 95% Pure R134a



Mastercool®
World Class Quality™

Leak Detection Fluid

LeakFinder Coolant Dye (6) 1 Oz. Bottles

- SKU 764995
TRALF3001 **19⁹⁹**
- (6) 1 Oz. (30 ml) Bottles for All Conventional Coolants
 - Find Leaks in Radiators, Hoses, Heater Cores, Water Pumps and Fittings
 - Services (1) Vehicle
 - Glows Green
 - Works with All Leak Detection Flashlights



Comes In Box of (6)
1 Oz. (30 ml) Bottles

LeakFinder Dye Oil (6) 1 Oz. Bottles

- SKU 764986
TRALF2001 **24⁹⁹**
- (6) 1 Oz. (30 ml) Bottle for Oil-Based Fluids
 - Find Leaks in Oil, Fuel, ATF and Power Steering Systems
 - Services (1) Vehicle
 - Glows Yellow/Green
 - Works with All Leak Detection Flashlights



LeakFinder AC Dye 8 Oz. Bottle

- SKU 764998
TRALF1008 **34⁹⁹**
- 8 Oz. (237 ml) Twin-Neck Bottle Universal A/C Dye
 - Find Leaks in A/C Systems; Compatible with R-134A, R-1234YF, and Other Refrigerants
 - Services Up to 32 Vehicles
 - Meets SAE J2297
 - Glows Green
 - Works with All Leak Detection Flashlights
 - Note: Not for Use in Hybrid Vehicles with Electrically Driven A/C Compressors



1 Oz. Bottle Dye-Lite® All-In-One™ Oil Dye (6 Pack)

- SKU 291395
TRATP3405 **34⁹⁹**
- Patented Formulation Works with Any Leak Detection Lamp



LeakFinder AC Dye (6) 1 Oz. Bottles

- SKU 764990
TRALF1001 **39⁹⁹**
- (6) 1 Oz. (30 ml) Bottle Universal A/C Dye
 - Find Leaks in A/C Systems; Compatible with R-134A, R-1234YF, and Other Refrigerants
 - Services Up to 4 Vehicles
 - Meets SAE J2297
 - Glows Green
 - Works with All Leak Detection Flashlights
 - Note: Not for Use in Hybrid Vehicles with Electrically Driven A/C Compressors



Big EZ 8 Oz. LeakFinder AC Dye Cartridge

- SKU 764997
TRALF1800 **44⁹⁹**
- 8 Oz. (237 ml) Replacement Dye Cartridge
 - Services Up to 64 Vehicles
 - Note: Cartridge Fits Most Caulking Guns



1 Oz. Bottle Fluoro-Lite® Universal/POE A/C Dye (6 Pack)

- SKU 291398
TRATP38400601 **54⁹⁹**
- Pourable Dye for Use with Many Dye Injectors or Simply Pour into an Open System
 - Includes 4 Applications for Standard Sized Systems



BigEZ™ 8 Oz. Universal Dye Cartridge

- SKU 291396
TRATP97700108 **64⁹⁹**
- Treats Up to 64 Vehicles
 - Fits Most Caulking Gun Injectors Including TRATP9790



Universal Concentrated Dye Cartridge - 1 Oz. (5 Pack)

- SKU 505040
MSC53810-5 **94⁹⁹**
- 5 Pack of Dye for 53585 Leak Detector Kit
 - 10 Applications per Bottle



A/C Service Tools

Deluxe A/C Clutch Hub Puller and Installer

- SKU 695099
33627150 **99⁹⁹**
- For Removal and Installation of AC Compressor Clutches for Ford, GM and Chrysler



Radiator/Condenser Cleaning Wand

- SKU 514015
THX467A **89⁹⁹**
- New, Improved High Pressure Air/Water Cleaning Wand Reaches 24 Inches Between Radiator and Condenser, Under Mowing Decks, etc. to Clean Away Dirt and Debris
 - Made of Zinc-Plated Steel with Adjustable Valve Assembly
 - Special Tips Deliver Air or Water at a 90 Degree Angle



A/C Compressor Pulley Removal Tool

- SKU 695609
33627001 **45⁹⁹**
- Makes AC Compressor Pulley Removal Jobs Fast and Easy
 - Can Be Used with OEMTOOLS™ 27008 Clutch Puller Jaws



Orifice Tube Remover Set

- SKU 752530
24562 **39⁹⁹**
- To Use, Simply Turn into Orifice Tube for Grip Then Turn Out
 - Includes Auger for Removing Broken Orifice Tubes



A/C Clutch Hub Remover

- SKU 695628
33627005 **30⁹⁹**
- Removes Club Hub from Ford ES-6 Compressors



A/C Clutch Holding Tool

- SKU 695102
33627000 **25⁹⁹**
- Holds Compressor Clutch in Place When Removing Holding Bolt
 - Adjust Pins to Fit Holes in Clutch



Compressor Turner Tool™

- SKU 504135
AIR67700 **29⁹⁹**
- OEM-Approved Compressor Startup Assistance
 - Prevent New Compressor Seizure at Startup
 - Fits Most Hex-less Clutch Hubs

AIRSEPT®



A/C Clutch Hub Plate Remover

- SKU 695626
33627006 **23⁹⁹**
- Removes Club Hub from the Compressor
 - For Use with Chrysler C-171, A590, 6C17 and Tecumseh HR-980 Compressor Clutches



A/C Clutch Puller Jaws

- SKU 695624
33627008 **23⁹⁹**
- Additional Jaws for Use with the OEMTOOLS™ 27001 AC Pulley Puller



A/C Orifice Tube Tool

- SKU 695629
33627004 **21⁹⁹**
- Fits Many GM and Ford Models



A/C Clutch Plate Remover Shoe Tool

- SKU 695630
33627002 **21⁹⁹**
- Used for GM A6 and R4 Compressor Clutches
 - Simply Screw into Clutch and Turn Pressure Screw to Remove



A/C Clutch Hub Installer

- SKU 695625
33627007 **17⁹⁹**
- For Use in Conjunction with OEM 27006, A/C Clutch Hub Plate Remover to Install Chrysler C-171, A590, 6C17 and Tecumseh HR-980 Compressor Clutches



A/C Condenser Fin Comb Straightener/Cleaner

- SKU 466317
24526 **12⁹⁹**
- Clean and Straighten Condenser and Evaporator Coils
 - Compact Design for Confined Spaces
 - Includes 6 Clearly Marked Combs: 8, 9, 10, 12, 14 and 15 Fins per Inch



A/C Valve Core Tool Set

- SKU 466314
24555 **9⁹⁹**
- Set of Two Double Ended Valve Core Tools to Service Both Standard and Large Bore R134a and R12 Cores

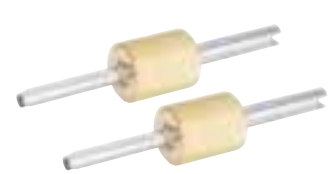

A/C Hose and Line Repair

FIX or TERMINATE a Line in 5 MINUTES!



CERTIFIED LEAK-FREE

UP TO 2600 PSI
OE-APPROVED REPAIR
SOLUTION INSTALLS
IN MINUTES NO SPECIAL
TOOLS, NO GLUE

SAVE TIME & MONEY!

Line Splice Straight Repair Kit **AIRSEPT.**

- Effective, Durable Leak Repair with No Line Removal
- 5 Minute Install with a Wrench (No Special Tools, No Adhesives Required)
- High-Tech Anti-Vibration Tension Ring Ensures Durability in Tough Automotive Applications
- HNBR Seal Sleeve Dramatically Expands the Sealing Surface Area
- Burst Tested to 2600 PSI



SKU	Part #	Size	Price
SAE			
504140	AIR76003	5/16" Line	\$34.99
504138	AIR76002	3/8" Line	\$34.99
504136	AIR76001	1/2" Line	\$34.99
504143	AIR76011	5/8" Line	\$44.99
504145	AIR76012	3/4" Line	\$44.99
METRIC			
504132	AIR77008	8 mm Line	\$34.99
504155	AIR77010	10 mm Line	\$34.99
504156	AIR77012	12 mm Line	\$34.99
504133	AIR77015	15 mm Line	\$44.99
504117	AIR77016	16 mm Line	\$44.99

Line Splice Straight Repair Kit Reducer

SKU	Part #	Size	Price
504141	AIR76004	3/8" to 5/16" Line	\$34.99
504095	AIR76005	1/2" to 5/16" Line	\$34.99
504142	AIR76006	1/2" to 3/8" Line	\$34.99

Smart Splice™ Line to Hose

When a Metal-to-Rubber A/C Line is Damaged, You Often Must Replace the Complete OE Line. If the Line is Not in Stock Locally, You Inconvenience Your Customer by Waiting for a Replacement Line. Quickly and Easily Connect A/C Reduced Barrier Hose to Metal Line Using AirSept's Smart Splice Line-to-Hose Connector™.

- Leak-Proof Line Splice™ Technology on the Metal Side of the Connection
- Superior Hose Crimp Technology on the Rubber Side
- Works for Heater and Coolant Lines Also
- Install in 5 Minutes



SKU	Part #	Size	Price
504125	AIR76701	1/2" Line to #8 Hose	\$34.99
504128	AIR76702	3/8" Line to #6 Hose	\$34.99
504129	AIR76703	5/16" Line to #6 Hose	\$34.99
504130	AIR76704	5/8" Line to #10 Hose	\$44.99
504131	AIR76705	3/4" Line to #12 Hose	\$44.99

Line Terminator Rear A/C Blockoff Kits

OE-Approved Rear A/C Block-Off Kits Block Damaged or Unused A/C Lines — No Line R and R. Save Time and Satisfy Customers. Leaking Rear A/C Components or Lines Can Result in High Operating or Repair Costs. Many Car Owners Would Rather Avoid That Expense and Operate the Front A/C Unit Only. With AirSept's Line Terminator, You Can Give Your Customers an Affordable (Yet Still Profitable) Alternative to the High Cost of Repair or Replacement Labor.

- Quickly and Effectively Blocks A/C Lines at the Damage Point or at the Front System "Y"
- Block-Off Leaking Rear Evaporators and Failed System Components
- Help Maximize Front A/C Performance
- Eliminate Refrigerant and Oil Pooling in Rear A/C Lines

SKU	Part #	Size	Price
504149	AIR76502	3/8" Line	\$24.99
504146	AIR76501	1/2" Line	\$24.99
504152	AIR76504	5/8" Line	\$29.99
504154	AIR76505	3/4" Line	\$34.99

Manual Style A/C Hose Crimper, Bench or Vise Mounted

- Manual Style A/C Hose Crimper
- Mount to Bench Using Holding Fixture or Place in Vise
- Includes: 71500 - 001 Yoke Assembly, 71500 - 002 Arbor Assembly, 71500 - 003 Holding Fixture Assembly, 71500 - 6 Die Set - #6 (5/16"), 71500 - 8 Die Set - #8 (13/32"), 71500 - 10 Die Set - #10 (1/2"), 71500 - 12 Die Set - #12 (5/8"), and 71500-PB Custom Mold Box Carrying Case



AIRSEPT.

Line Splice Straight SAE (5 Pack) and Line Terminator SAE (5 Pack) Combo **SAVE \$49⁹⁹**

SKU 032916
AIR5PKCOMBO

AIR76526	Line Terminator SAE - 5 Pack	\$94.99
AIR76050	Line Splice Straight SAE - 5 Pack	\$149.99
	Regular Price	\$244.98
AIR5PKCOMBO	COMBO PRICE	\$194.99
	SAVINGS	\$49.99

Valid through March 31, 2019

Line Terminator SAE - 5 Pack

- SKU 504122 **94⁹⁹**
AIR76526
- Quickly and Effectively Blocks A/C Lines at the Damage Point or at the Front System "Y"
 - Block Off Leaking Rear Evaporators and Failed System Components
 - Include One Each: 5/16", 3/8", 1/2", 5/8" and 3/4" SAE Kits



Line Splice Straight SAE - 5 Pack

- SKU 504101 **149⁹⁹**
AIR76050
- Effective, Durable Leak Repair with No Line Removal
 - OE Approved
 - 5 Minute Install - No Special Tools
 - Includes One Each: 5/16", 3/8", 1/2", 5/8" and 3/4" Line Splice Kits



AIRSEPT.

Line Terminator SAE/Metric · 10 Pack

- SKU 504124 **189⁹⁹**
AIR76530
- Quickly and Effectively Blocks A/C Lines at the Damage Point or at the Front System "Y"
 - Block Off Leaking Rear Evaporators and Failed System Components
 - Includes One Each: 5/16", 3/8", 1/2", 5/8" and 3/4" SAE Kits; Plus One Each: 8 mm, 10 mm, 12 mm, 15 mm and 16 mm Metric Kits



AIRSEPT.

Line Splice Straight SAE/Metric · 10 Pack

- SKU 504103 **279⁹⁹**
AIR76051
- Effective, Durable Leak Repair with No Line Removal
 - OE Approved
 - 5 Minute Install - No Special Tools
 - Includes One Each: 5/16", 3/8", 1/2", 5/8" and 3/4" SAE Line Splice Kits; Plus One Each: 8 mm, 10 mm, 12 mm, 15 mm and 16 mm Metric Line Splice Kits



Mastercool®

World Class Quality™

RI34a/RI2 Charging Hose Repair Kit

- SKU 295557 **44⁹⁹**
MSC91334-A
- 55 Piece Assortment of Replacement Gaskets, O-rings, Depressors for Charging Hoses and Adapters



AIRSEPT.

Airsept Smart Splice™ Ultimate Line Repair Kit

- SKU 687976 **1,849⁹⁹**
AIR76057
- Everything Needed to Repair A/C, Power Steering Return, Transmission, Trans Oil Cooler, Engine Oil, Engine Oil Cooler, Coolant and Heater Lines
 - OEM Approved Line Repair Solution Installs in Five Minutes, on the Vehicle, without Special Tools or Adhesives
 - Leak Free Up to 2600 PSI



8,000 Line Repair Options in 1 Box!

Smart Splice™ Multi-System Line Repair Tray

- SKU 687973 **479⁹⁹**
AIR76076
- Includes One Each: 5/16", 3/8", 1/2", 5/8", 3/4" Line Splice Straight SAE Repair Kits: 8 mm, 10 mm, 12 mm, 15 mm, 16 mm Line Splice Straight Metric Repair Kits: 5/16", 3/8", 1/2", 5/8" Line Splice 45° SAE Repair Kits: 5/16", 3/8", 1/2", 5/8" Line Splice 90° SAE Repair Kits
 - Top Tray in Master Cabinet



Smart Splice™ Line Terminator and Service Tee Repair Tray

- SKU 687974 **524⁹⁹**
AIR76077
- Everything Needed to Block Off A/C, Coolant and Heater Lines, or Add an A/C Service Port
 - SAE Sizes: OD Metal Lines 1/2", 3/8", 1/2", 5/8", 3/4" OD Metal Lines
 - Metric Sizes: OD Metal Lines: 8 mm, 10 mm, 12 mm, 15 mm, 16 mm



Smart Splice™ Hose to Tube, Hose to Hose Repair Tray

- SKU 687975 **579⁹⁹**
AIR76078
- Everything Needed to Make Hose to Line or Hose to Hose Repairs on A/C, Coolant and Heater Lines
 - SAE Sizes: OD Metal Lines) 5/16", 3/8", 1/2", 5/8", 3/4" OD Metal Lines, SAE Sizes for #6, #8, #10, #12 3/4", A/C Reduced Barrier Hose



Smart Splice™ Aluminum Tube Insert Service Tray

- SKU 687989 **229⁹⁹**
AIR76079
- Repair Long Sections of Damaged or Leaking A/C, Power Steering Return, Transmission, Trans Oil Cooler, Engine Oil, Engine Oil Cooler, Coolant and Heater Lines
 - Includes 12" Lengths of Aluminum Tubing for SAE and Metric Lines



5 Piece Smart Splice™ Tool Assortment

- SKU 688003 **169⁹⁹**
AIR76080
- Includes: Deburring Tool, Tube Cutter, Caliper, Pex Crimper, Rubber Hose Crimper



COOLING SYSTEM

DID YOU KNOW?

AutoZone® carries a full line of truck accessories and parts

Contact Your AutoZone Commercial Sales Manager for Details

Cooling System Tools

Water Pump Holding Tool for GM

SKU 094808 27207 **19⁹⁹**

- Use for 2002 - 2008 GM 2.2L and 2.4L Eco Tech Engine in Chevrolet, Oldsmobile, Pontiac and Saturn Platforms
- Updated Half Moon Design Saves Time



No-Spill Coolant Filling Funnel Kit

SKU 802197 87009 **29⁹⁹**

- 5 High Quality 1 Piece Adapters - No Assembly or Searching for Loose Parts
- Simply Select the Correct Adapter, Attach the Funnel and Fill
- Includes Extensions and Adapters for Hard-to-Reach Surge Tanks



2.4 Gallon Plastic Radiator Filler

SKU 754738 87104 **17⁹⁹**

- Impervious to Oil, Gasoline and Antifreeze
- Stands Up to Extreme Weather
- Double Handles on the Back and Top Make it Easy to Pick Up and Easy to Control



Cooling System Back Flush Tool

OEM TOOLS™

SKU 750008 24506 **29⁹⁹**

- Hose Fittings: 1/2", 5/8" and 3/4"
- Connects to a Normal Garden Hose
- Made of Non-Corrosive Aluminum
- Easy to Use



4 Piece 15" Jumbo Pick Set

SKU 094658 25940 **27⁹⁹**

- Includes: Straight, 90°, Offset and Hook Pick
- Chrome Vanadium Steel for Strength and Durability
- Chrome Finish to Resist Rusting
- Cushion Grip Handles



Color May Vary

Master Freeze Plug Installation Tool Kit

SKU 965837 27208 **69⁹⁹**

- Designed to Remove and Install Freeze Plugs Used in Liquid-Cooled Gas and Diesel Engines



Hose Tools

Locking Hose Pinch-Off Pliers

SKU 626110 24431 **11⁹⁹**

- Clamp Cooling System Hoses Up to 1-1/4" (30 mm) in Diameter
- Features Locking Ratchet Mechanism to Hold Jaws Tightly in Place
- Eliminates the Need to Drain the Radiator When Servicing Cooling System



3 Piece Hose Pinching Pliers Set

SKU 013529 24689 **12⁹⁹**

- Designed to Clamp Hoses Shut and Lock Them into Place
- Clamps Fuel Injection, Brake, Vacuum and Cooling System Hoses
- Designed with Smooth, Rounded Jaws to Prevent Hose Damage
- Small: 1/8" to 5/16" Medium: 1/2" to 3/4" Large: 3/4" to 2-1/2"



STORE STOCKED

5 Piece Hose Clamp Pliers Set

SKU 965836 27159 **34⁹⁹**

- Serves Most Ring-Type or Flat-Band Hose Clamps
- Jaws Swivel to Access Hose Clamps in Any Position



Product May Vary

2 Piece Hose Clamp Pliers

OEM TOOLS™

SKU 972767 25198 **17⁹⁹**

- Includes Flat-Band Hose Clamp Pliers and Angled Hose Clamp Pliers
- Thick, Double-Dipped Handles for a Comfortable and Firm Grip
- Serves Most Ring-Type or Flat-Band Hose Clamps
- Jaws Swivel to Access Hose Clamps in Any Position
- Clamps are Held Open with a Ratchet Locking Mechanism

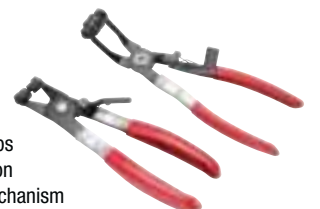

Hose Clamp Pliers

SKU 607069 25246 **36⁹⁹**

- Removes Plastic and Metal Self-Tightening Hose Clamps with Diameters of 11/16" to 2-1/2"



Color May Vary

Cooling System Testing

Professional Series Ethylene Glycol Antifreeze Tester

SKU 750007 24507 **12⁹⁹**

- For Testing Hot or Cold Ethylene Glycol-Based Coolants Including Dex-Cool®
- Easy-to-Read Discs are Magnified by Convex Design of the Clear, Thermal Resistant Plastic Barrel
- Disc-Type 16-1/4" Tester is Accurate at All Temperatures
- Celsius and Fahrenheit Scales



Combustion Leak Detector Fluid (8 Oz.)

SKU 391381 25739 **8⁹⁹**

- Test for Internal Combustion Leaks on Gasoline Engines
- Fluid Turns Yellow When Exhaust Gases are Present in Cooling System



Combustion Leak Detector

SKU 695104 33627145 **25⁹⁹**

- Locate Internal Combustion Leaks Quickly and Easily
- When Fluid Turns from Blue to Yellow a Combustion Leak is Present



Coolant and Battery Refractometer

SKU 471116 RO875240 **59⁹⁹**

- Can Be Used for Measuring the Freezing Point of Either Propylene or Ethylene Glycol Based Cooling Systems
- Can Also Be Used for Checking the Strength of Electrolyte Solution Batteries
- This Precision Instrument Features High-Quality Optics with Ultra-Smooth Focusing
- Scale Range: -60° F To 32° F



Disconnect Tools

Heater Hose Disconnect Tool

SKU 695607 33627106 **14⁹⁹**

- Removes Heater Hoses with 5/8" and 3/4" Quick Disconnect Couplings on Ford Aerostar Vans 1986 to Current and Full Size Ford Vans 2001 to Current
- Works on Rear Heater Hose Couplings on Chrysler and Plymouth 1986 to Current



Coolant Hose Removal Tool Set

SKU 383214 CAL244TNZ **29⁹⁹**

- Thicker Than Most Hose Disconnect Tools
- 40° Offset Designed for Jobs in Tight Spaces
- Low Profile Design for Ease of Use
- Set of Four Will Cover Quick Connect Hose Needs



Master Disconnect Set

SKU 821445 33627318 **90⁰⁰**

- Easily Disconnects A/C Lines, Fuel Lines and Transmission Cooler Lines
- Includes: Hydraulic Clutch Line Disconnect for GM, 3/8" and 5/16" Fuel Line Retaining Clips for GM, Air Conditioning/Fuel Line Disconnects: 5/16", 3/8", 1/2", 5/8", 3/4" and 7/8"
- Scissor Disconnects: 5/16" and 3/8"; 1/2" and 3/8"
- Ford: Fuel Line, Oil Cooler Line and Clutch Coupling Remover
- Coupler Disconnects
- Comes in a Sturdy Blow Mold Case

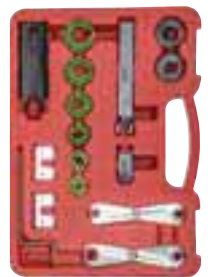

COOLANT PULSATOR COOLING SYSTEM FLUSH TOOL

HECAT

SKU 012619 HCT118550 **599⁹⁹**

- Reduce Come-Backs Caused by Low Coolant Flow and Premature Water Pump Failure
- Patented Pulsating Design Removes Restrictive Sludge, Debris, Sand and Scale Deposits from Heater Cores, Radiators, and Engines. Returns Coolant Flow and Cabin Heat to Like New.
- Included Accessories Connect with Quick Coupler - Large Rubber Cone, Whip Hose with Small Rubber Cone, 5/8" and 3/4" Hose Barb Connectors and Back Flow Preventer



Cooling System AirVac

Airvac Coolant Refiller

SKU 568478 24444 **79⁹⁹**

- Quickly Refills Cooling System and Eliminates Trapped Air
- Helps Prevent Come-Backs and the Threat of Engine Damage
- Performs Vacuum Leak Tests
- Covers Most Radiator and Reservoir Types



Cooling System AirVac Kit

SKU 099292 27066 **84⁹⁹**

- Uses Shop Air to Evacuate the Cooling System for Vacuum Leak Testing
- Refills Cooling System without Trapping Air That Causes Overheating
- Universal Adapter Forms an Airtight Seal with Radiator and Coolant Bottle Necks
- Self-Locking Quick Disconnects for Fast Assembly



Cooling System Testers

Cooling System Pressure Test Pump
 SKU 434722 27069 **69⁹⁹**

- Quickly and Easily Pressure Test Cooling Systems in Most Vehicles
- High Quality Pressure Pump Designed to Work with Most Cooling System Adapters
- Easy Lever Style Pressure Relief Valve



Universal Cooling System Adapter Set
 SKU 434723 27067 **79⁹⁹**

- Designed to Fit Most Passenger Vehicles and Light-Duty Trucks
- Fits Both Radiators and Plastic Reservoirs
- Universal Design Works with Any Cooling System Pressure Pump
- Pressure Test Pump Not Included



Universal Cooling System Pressure Test Kit
 SKU 434717 27068 **104⁹⁹**

- Quickly and Easily Pressure Test Cooling Systems in Most Vehicles
- Includes 3 Expandable Adapters That Take the Place of Numerous Specialized Adapters
- Prevents Damage to Plastic Reservoir Threads That Occurs When the Wrong Adapter is Forced On



Cooling System Pressure Test Set
 SKU 391374 27065 **104⁹⁹**

Works with the OEMTOOLS™ Adapters (See Below).

- (2) 32 mm (9.5 mm and 15 mm Depth) Radiator Adapters are Included to Fit a Variety of Radiators on the Market
- Cap Adapter for These Systems is Also Included
- System Works with Most Other Tester Systems
- Pump is Corrosion Resistant



SmartFit™ Universal Cooling System Test Kit
 SKU 250709 RED950700 **169⁹⁹**

- Works on All Passenger Vehicles and Light-Duty Trucks
- Eliminates the Need to Buy Costly Adapters for Radiators
- Made from Anodized Brass and High Quality Materials
- Made in the U.S.A.



Adapters

Acura, Chevrolet, Chrysler, Geo, Honda, Isuzu, Lexus, Mazda, Mitsubishi, Suzuki and Toyota
 SKU 133624 27244R **29⁹⁹**

- Fits Early Models Directly to Radiator with 32 mm Opening and a 9 mm Depth



BMW
 SKU 133634 27250R **34⁹⁹**

- Fits Models with Threaded Filler Necks Up to 1987
- Diameter: 32 mm; Thread Size: 3 mm



BMW and Range Rover
 SKU 133635 27251R **29⁹⁹**

- Fits BMWs from 1988 - 2006, Land Rover and Range Rover Models 1995 - 2005
- Diameter: 52 mm; Thread Size: 4 mm



BMW 3 Series (2006 and Later) and 5 and 6 Series (2005 and Later)
 SKU 133825 27252R **34⁹⁹**

- Diameter: 52 mm; Thread Size: 3 mm



Cadillac, Chevrolet, Geo, GMC, Pontiac, Ford, Oldsmobile and Saturn
 SKU 133621 27118R **34⁹⁹**

- Fits GM 1999 and Later That Use an O-Ring Seal



Mazda 3, Volvo S40/V50 and Ford Radiator Adapter
 SKU 133633 27249R **34⁹⁹**

- Fits Land Rover LR-2 (2008 - Up), Mazda 3 (2004 - Up), Volvo S40 and V50 (2004 - Up), XC60 (2010 - Up), Ford Fusion and Escape (2012 - Up)
- Diameter: 50 mm; Thread Size: 2.5 mm



Mercedes-Benz and Chrysler
 SKU 133626 27246R **34⁹⁹**

- Fits Mercedes-Benz with Threaded Filler Necks Except the M-Class (1998 - 2005) and Chrysler Crossfire (2004 - 2008)



Ford, Jaguar, Pontiac, Range Rover and SAAB
 SKU 133611 27243R **29⁹⁹**

- Fits Jaguar X Type (2002 - Up), SAAB 900 (1994 - 1998), SAAB 9-3 and 9-5 (1999 - Up), Some Saturns and Other Vehicles
- Diameter: 52 mm; Thread Size: 3 mm



Import
 SKU 695123 33627112 **45⁹⁹**

- Fits Nissan, Datsun, Mitsubishi, Mazda, Subaru and Toyota Systems
- Also Fits Honda Motorcycles with a 45 mm Cap
- Diameter: 32 mm; Depth: 16 mm



Toyota, Lexus and Scion
 SKU 133632 27248R **34⁹⁹**

- Fits Lexus LS (2007 - Up), Toyota Celica (2000 - Up), Spyder MR2 (2000 - Up), RAV4 (2009 - Up), Prius (2004 - Up), Camry (2007 - Up), Highlander (2006 - Up) and Scion XB (2008 - Up)



Volvo, SAAB, Jeep, Maserati and Ferrari
 SKU 133600 27241R **29⁹⁹**

- Fits Maserati and Ferrari Models (2000 - Up), Jeeps with Male Threads (1990 - 1994), SAAB 900 (1978 - 1993), SAAB 900 (Drop Top 1994), SAAB 9000 (1987 - 1998), Volvos with Male Threaded Necks
- Diameter: 45 mm; Thread Size: 3 mm



Audi and VW
 SKU 133549 27240R **29⁹⁹**

- Fits Audi and VW with Male Threads on Filler Neck, Porsche Boxster (1997 - Up), Cayenne (2006 - Up), 911 (1999 - Up)
- Outside Diameter: 48 mm; Thread Size: 3 mm



Audi, VW and Others
 SKU 133625 27245R **34⁹⁹**

- Fits Audi A4 (1996 - Up), A6 (1998 - Up), A8 (1997 - Up), S4 (2004 - Up), TT (2000 - Up), Bentley (2006 - Up), Lamborghini (2006 - Up), Porsche Cayenne (2003 - Up), Porsche Panamera (2010 - Up), Volkswagen Passat (1998 - Up), Beetle (1998 - Up), Golf and Jetta (1999 - Up)



VW
 SKU 133609 27242R **29⁹⁹**

- Fits Volkswagens with Female Threaded Filler Necks (1990 - 1998)



AVAILABLE WHILE SUPPLIES LAST

Coolant Exchange Equipment

Cool-Maxx 2 Tank Coolant Exchanger w/Startup Kit
 SKU 032797 MXMMX2COMBO **2,349⁹⁹**

- 2 Fiberglass Tanks with 10 Gallon Capacity
- Allows Coolant/Antifreeze Exchange Directly from the Radiator Spout or Expansion Tank
- Heavy Duty Aluminum Design
- Energy Saving—No Electricity or Batteries Required
- Eliminates Spills

Includes 12 Bottles Each Radiator Flush & Conditioner Value \$278.88



Coolant not included

Cool-Maxx 3 Tank Coolant Exchanger w/ Startup Kit
 SKU 032795 MXMMX3COMBO **2,599⁹⁹**

- 3 Fiberglass Tanks with 10 Gallon Capacity
- Allows Coolant/Antifreeze Exchange Directly from the Radiator Spout or Expansion Tank
- Heavy Duty Aluminum Design
- Energy Saving—No Electricity or Batteries Required
- Eliminates Spills

Includes 12 Bottles Each Radiator Flush & Conditioner Value \$278.88



Coolant not included

VCX-1 Vacuum Coolant Exchanger
 SKU 573048 MSS4708001900 **2,579⁹⁹**

- Extremely Fast Service Cycles
- Simple Hook-Up and Operation
- Flexible Adaptation for Most Makes and Models



Coolant not included

FluidPRO® VCX-4 Vacuum Coolant Exchanger
 SKU 574376 MSS4708002000 **3,759⁹⁹**

- 4 Transparent, Large Capacity Cylinders; Three for New Coolant and One for Waste
- Easy Coolant Selection/Changeover for Flexible Adaptation of Most Vehicles
- Fast Service Cycles of 5-15 Minutes for Increased Productivity



Coolant not included

VFX1 Radiator Coolant Exchanger
 SKU 112467 SYM35010000 **2,899⁹⁹**

- Dual Mode Functionality, In-Line Back Flush or Vacuum Drain-N-Fill
- With the Vacuum Capability, Air Locks are Eliminated Quickly
- Shop Air Operation
- Multi-Fluid Tank Exchange, (2) Interchangeable New Fluid Tanks
- 15 Gallon Used Fluid Tank
- High Efficiency "Engine Off" Flush
- Pressure Check/Vacuum Test
- All Adapters Included



Coolant not included

FluidPRO® MCX-2HD Multi-Coolant System Fluid Exchanger
 SKU 575159 MSS4708003200 **2,889⁹⁹**

- Compatible with All Coolant Types for Adaptability
- Contains (2) 15 Gallon New Coolant Tanks and (1) 15 Gallon Waste Tank Providing Simple, Rapid Switching from One Coolant to Another
- 3 Minute Service Time for Increased Productivity



Coolant not included

FluidPRO® MCX-2 Multi-Coolant System Fluid Exchanger
 SKU 574749 MSS4708003000 **2,579⁹⁹**

- Includes System Pressure Test Feature and "Hot Car" Radiator Cap Pressure Release
- Compatible with All Coolant Types for Adaptability
- Contains (2) 7.5 Gallon New Coolant Tanks and (1) 15 Gallon Waste Tank Providing Simple, Rapid Switching from One Coolant to Another
- 3 Minute Service Time for Increased Productivity



Coolant not included

CHASSIS/ SUSPENSION

Tie Rod Tools



Master Inner Tie Rod Tool Set

SKU 344979
27178 **90⁹⁹**

Works on Both Small Cars and SUVs

- Tube Handle Has an Inner Diameter of 2.125" to Service Small Cars, Pickups and Large SUVs
- Includes 12 Crowfoot Style Adapters, Sizes: 29 mm, 1-3/16", 1-1/4", 32.5 mm, 1-5/16", 33.6 mm, 1-3/8", 1-7/16", 1-1/2", 38.4 mm, 40 mm and 42 mm
- Comes in a Blow Mold Case

Inner Tie Rod Tool

SKU 094645
25296 **19⁹⁹**

- Use to Easily Turn Tie Rods
- Use with an Extension, Tighten Nuts on U-Bolt as Needed
- Tool Can Remove Inner Tie Rod without Removing the Outer Tie Rod

STORE STOCKED

Inner Tie Rod Tool Kit

SKU 217377
27185 **49⁹⁹**

- Removes and Installs Tie Rod End on Rack and Pinion Steering
- Includes: 1-3/16", 1-5/16" and 1-7/16"



Tie Rod End Remover

SKU 695086
33627175 **40⁹⁹**

- Used on Imports and Many Front Wheel Drive Vehicles and Rack and Pinion Steering
- Pressure Screw Tip Swivels for Damage Free Results and Will Not Damage Tie Rod End Dust Boots



Inner Tie Rod Tool

SKU 291414
LIS45750 **89⁹⁹**

- Utilizes Six Sizes: 1-3/16", 1-1/4", 1-5/16", 1-7/16", 1-1/2" and 33.6 mm
- Long Socket Slips Over Tie Rod End and Connects to the Crowfoot
- Includes 1-1/2" Crowfoot for Use on Chevrolet Colorado and GMC Canyon



Master Inner Tie Rod Tool

SKU 080557
LIS46800 **149⁹⁹**

- Works on Inner Tie Rods with Inaccessible Wrench Flats
- Includes 9 Crowfoot Style Adapters to Work on Various Applications
- Long Socket Slips Over the Tie Rod End and the Crowfoot Engages on the Socket for Easy Removal and Installation



Hub Bearing

23 Piece Hub Bearing Remover and Installer Kit

SKU 094804
27205 **199⁹⁹**

- Removes and Installs Wheel Bearings with Steering Knuckle and Strut Assembly Still on the Vehicle, Eliminates Need for Alignment

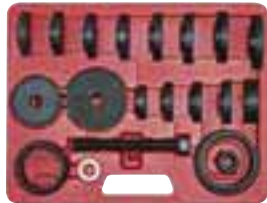

Master Wheel Hub and Bearing Remover and Installer Kit

SKU 298230
27213 **449⁹⁹**

- For Removal and Installation of Front Wheel Hub and Bearings on Asian, Domestic and German Vehicles Along with Rear Wheel Hubs and Bearings on European Vehicles
- Works on Front, Rear and All-Wheel Drive Vehicles
- Self Centering Design is Incredibly Durable and Easy to Use
- Broader Application with Fewer Components Than Many Other Tools



OTC Hub Grappler™

SKU 096847
OTC6575 **599⁹⁹**

- Complete Solution for Servicing Wheel Hubs and Bearings on the Vehicle without Removing the Steering Components or Knuckle - Eliminates Unnecessary Alignments or the Use of a Shop Press
- Applies Maximum Force with Minimal Effort from an Impact Gun



Seal Tools

Seal Puller

SKU 048199
25014 **12⁹⁹**

- Two Tips Fit All Seal Sizes



Transmission/Transaxle Plugs

SKU 298196
24490 **19⁹⁹**

- Includes Five Plugs to Seal Both Transmissions and Transaxes on Most Import and Domestic Vehicles
- Stepped Design for Retention and Positive Sealing
- Includes Side Gear Centering Pin for Ford Transaxes



Universal Seal Installer Kit

SKU 818737
25082 **34⁹⁹**

- Knurled Handles
- Includes: 3" Driver, 2.5" Driver, Short Handle, Long Handle, Spider Insert, 5/16" x 1" Cap Screw, Large Spider, Small Spider and Washer
- Long Handle Provides Good Flexibility When Installing Pinion Seals
- Comes in a Sturdy Blow Mold Case



Bearing Race and Seal Driver Set

SKU 695119
33627119 **74⁹⁹**

- Used to Install Most Standard Wheel Bearing Races and Seals

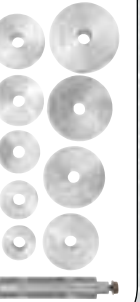

Spring Compressors

Universal Strut Remover

SKU 141509
25423 **24⁹⁹**

- Removes the Top Nut on Many MacPherson Struts
- Deep Socket is Used to Remove Nut
- Includes: 3/4" Adapter, 6.5 mm Hex, "Double D" and 7.5 mm Hex and "Double D" Sockets
- Comes with T-50 Star, 10 mm Internal Hex and "Double D" Sockets



MacPherson Strut Spring Compressor

SKU 070135
25550 **34⁹⁹**

- Used to Compress Strut Spring During Cartridge Replacement
- Forged Hook
- Heat-Treated Forcing Screw
- Safety Latches



Model 7600 Strut Spring Compressor

SKU 547959
BRA7600 **889⁹⁹**

- Handles the Toughest Applications
- Min./Max. Spring Diameters: 3.5" / 11.5"
- No Adapters Required



StrutTamer™ II Extreme with Stand

SKU 471100
OTC6637-ST **899⁹⁹**

- Meets the New ASME PASE Standards for Spring Compressors
- Capable of Safely Compressing the Largest Strut Springs
- New Forged Locking Jaws Include Larger Pads and Offset to Clamp onto and Compress Springs Even Tighter Than Before
- Unique Trunnion Locking Mechanism to Eliminate Arm Movement for Stable Compression



Coil Spring Compressor

SKU 695608
33627035 **50⁹⁹**

- Used to Compress the Coil Spring in the Installation of Coil Spring Spacers
- Comes in a Sturdy Blow Mold Case



Strut/Coil Spring Compressor Kit

SKU 094802
27203 **79⁹⁹**

- Used to Compress Most Sizes of MacPherson Springs and Coil Springs
- 10 Piece Kit
- Heat-Treated for Toughness
- Comes in a Blow Mold Case



Suspension

GM Upper Control Arm Knock Out Tool

SKU 420336
24210 **19⁹⁹**

- Services 1989-2001 Chevrolet and GMC 1/2, 3/4 and 1 Ton, 2 and 4 Wheel Drive Trucks and 1990-2002 All Wheel Drive Chevrolet Astro and GMC Safari Vans



Universal Steering Knuckle Spreader Tool

SKU 512957
27234 **59⁹⁹**

- Used to Spread Lower Ball Joint, Preventing Costly Damage to Knuckle



Camber Adjustment Tool

SKU 360484
DOWTC614 **254⁹⁹**

- Makes Camber Adjustment a "One-Man Job"
- Inflatable Air Bladder Fits Between Tire and Strut for Easy and Controlled Adjustment of Camber Settings
- Camber Can Be Set with Wheels on Ground
- Eliminates the Need for Special Camber Bolts



CV Axle Nut Sockets

6 Point Axle Nut Socket Set

SKU 900822
27188 **103⁹⁹**

- Includes Sizes: 27, 29, 30, 32, 34, 35, 36, 38 and 39 mm
- Chrome Moly Sockets are Impact Rated
- Black Oxide Finish to Resist Rust
- Comes in a Blow Mold Case



1/2" Drive Axle Nut Sockets

- 30 mm SKU 079988 | 25203 **14⁹⁹**
- 32 mm SKU 552315 | 25204 **14⁹⁹**
- 33 mm SKU 864643 | 25152 **14⁹⁹**
- 34 mm SKU 010252 | 25205 **14⁹⁹**
- 35 mm SKU 864642 | 25153 **18⁹⁹**
- 36 mm SKU 079772 | 25206 **19⁹⁹**

- Removes and Installs the Front Drive Hub/Axle Nuts on 4-Wheel Drive and Many Front Wheel Drive Automobiles
- For Use with a 1/2" Drive Ratchet
- 1/2" Drive Chamfered Square Drive

STORE STOCKED

12 Point Axle Nut Socket Set

SKU 751696
24480 **79⁹⁹**

- Includes Sizes: 29, 30, 32, 34, 35, 36, 38 and 39 mm
- Chrome Vanadium Sockets are Impact Rated
- Black Oxide Finish to Resist Rust
- Comes in a Blow Mold Case



12 PT Axle Nut Socket 1/2" Drive

17⁹⁹ EACH

- 29 mm SKU 821446 | 33627322
- 30 mm SKU 191051 | 25157
- 31 mm SKU 821448 | 33627324
- 32 mm SKU 821449 | 33627325
- 33 mm SKU 821451 | 33627326
- 34 mm SKU 821453 | 33627327
- 35 mm SKU 821455 | 33627328
- 36 mm SKU 821456 | 33627329
- 38 mm SKU 821457 | 33627330
- 39 mm SKU 821452 | 33627331

Shock Tools

Volvo Shock Retaining Nut Strut Removal Socket Tool

SKU 300125
24365 **24⁹⁹**

- Includes Holding Socket with "Double D" Axle Center Socket
- Fits Several Volvo Models 1999-2010



Universal Shock Absorber Tool

SKU 036202
25038 **19⁹⁹**

- For Removing and Installing Shock Nuts
- Fits Many Shock Stems



Unloading Tool

GM, Ford, Chrysler Torsion Bar Tool

SKU OUTSIDE BUY/EPO
33627278 **59⁹⁹**

- Safely Loads and Unloads 5-Lug, 6-Lug & 8-Lug GM, Dodge & Ford Torsion Bar Suspensions for Key Replacement
- Pressure Screw is 50% Larger, Includes a Longer Drive Hex to Reduce Tool Slippage, and a Higher Thread Engagement to Increase Durability
- Counter Hex at Base of C Frame Helps to Prevent Twisting of the Tool While Compressing Torsion Bar
- Includes Our New Special FORD/DODGE Adapter for Universal Use



Available via Outside Buy/EPO, Call 1-877-298-6651 for Ordering Instructions

Pitman Arm Pullers

Pitman Arm and Ball Joint Front End Service Kit

SKU 900820
27181 **89⁹⁹**

- Services Pitman Arm, Tie Rod and Ball Joints
- Includes: Pitman Arm/Tie Rod End Puller, Ball Joint Separator, Pitman Arm Puller, Ball Joint/Tie Rod End Remover
- Comes in a Sturdy Blow Mold Case





FREE OVERNIGHT SHIPPING
WITH MOST ORDERS
SEE PAGE 3 FOR DETAILS

Pickle Forks

Tie Rod End Puller

SKU 004463 **11⁹⁹**
25201

- Tapered Fork Wedged Ends with 21/32" Opening
- Overall Length: 11-7/8"

STORE STOCKED

Ball Joint Separator

SKU 004464 **11⁹⁹**
25202

- Tapered Fork Wedged Ends with 15/16" Opening

STORE STOCKED

5 Piece Pickle Fork Set

SKU 466511 **43⁹⁹**
25261

- Set Includes: Tie Rod Spreader with 11/16" Wedge Opening, Ball Joint Separator with 15/16" Jaw Opening, Pitman Arm Wedge with 1-1/8" Opening, 8" Handle

Stepped Pickle Fork Set

SKU 291410 **59⁹⁹**
LIS41400

- 6 Tools in One
- Includes: 11/16", 15/16", 1-1/8"
- Forks and 2 Handles

5 Piece Tie Rod and Ball Joint Set

SKU 094799 **59⁹⁹**
27201

- Used to Remove Tie Rods and Ball Joints
- Includes: 11" x 1-1/8", 11-5/8" x 1-7/16", 11-3/4" x 1-5/8", 16" x 11/16" and 16" x 15/16"

Spindle Nuts

1/2" Drive Socket Bearing Locknut

SKU 231203 **14⁹⁹**
25243

- Fits Adjusting Nuts Found on 1995-96 Ford F150 Trucks and Full-Sized Broncos with Automatic Locking Hubs

STORE STOCKED

Toyota 4-Pin Hub Locknut Socket

SKU 298224 **19⁹⁹**
25969

- Serves High-Torque Locknuts on Toyota 4WD Vehicles Having Free-Wheel (Lock Out) Hubs
- 1995-Newer Tacoma; 1996-Newer T100 and 4Runner
- Improved Design with Solid Pins for Increased Durability

Ball Joint Tools

3/4" Drive Ball Joint Impact Socket 2-9/64"

SKU 462494 **24⁹⁹**
24215

- Used on Chrysler/Dodge Mid Size Cars, Light-Trucks and Vans
- Fits 2-9/64" Ball Joints
- 3/4" Drive

Ball Joint Separator

SKU 793569 **29⁹⁹**
33627308

- Used for Separating the Ball Joint from the Spindle Support Arm on Domestic and Import FWD Vehicles
- Adjustable for Different Size Ball Joints
- Max. Opening Range: 1-1/8" and 2-1/8"
- Steel Construction with Black Oxide Pins
- Comes in a Sturdy Blow Mold Case

Hydraulic Ball Joint Separator

SKU 177718 **99⁹⁹**
25219

- Hydraulic Ram Rated to 8 Tons
- Jaw Capacity: 56 mm (2.25")
- Jaw Width: 22 mm (0.86")

4WD 4 Lug Spindle Socket

SKU 552265 **19⁹⁹**
25072

STORE STOCKED

Dodge Hub Locknut Socket

SKU 344964 **24⁹⁹**
25968

- Fits 1994 and Newer Dodge 1/2-Ton Pick-Up Trucks with Dana 44 Front Axle and Dana 60 Axle with a Vacuum Disconnect
- Designed to Accommodate the 1-11/16" (43 mm) Wheel Bearing Retaining Nut Which is Recessed into the Hub

Ball Joint Adapter Set Ford Van

SKU 695092 **85⁹⁹**
33627166

- Ford Van 2WD, Upper and Lower
- Ball Joint Adapter Set for #27023 and #33627023
- Rust Resistant Finish on All Parts

Honda Ball Joint Adapter Set

SKU 695094 **119⁹⁹**
33627164

- 1980-2000 Honda Accord, Civic, DelSol, CRX and Prelude

Ball/U-Joint Press Set

SKU 695617 **67⁹⁹**
33627023

- Removes and Replaces Ball Joints on Many Vehicles
- C-Clamp Frame Press May Also Be Used to Remove and Replace U-Joints

GM Axle Hub Nut Socket

SKU 298219 **29⁹⁹**
25967

- Applications: GMT900 Silverado, Sierra HDCS, 2-Wheel and 4-Wheel Drive Cheyenne, Silverado, Escalade, Sierra and Avalanche Trucks with 10.5" or 11.5" Ring Gear
- Has 9 Pins to Fit GM New Style Retaining Nuts
- Unapproved Methods Can Damage the Bearing, or Result in Shorter Service Life

Toyota 8 Pin Front Hub Locknut Socket

SKU 298205 **29⁹⁹**
25962

- Allows for Easy Removal and Installation of Front Hub Lock Nut without Damage to the Nut
- Applications 2007 - 2014 Toyota 4Runner 2WD, 2008 - 2014 Toyota Sequoia, 2007 - 2014 Toyota Tundra
- 3/4" Drive

Ford Ball Joint Adapter Set

SKU 695095 **89⁹⁹**
33627163

- 1996-2004 Ford Taurus and Mercury Sable
- Ball Joint Adapter Set for 27023 and 27089
- Rust Resistant Finish on All Parts

Master Ball Joint Installer/Remover Adapter Set

SKU 793562 **135⁹⁹**
33627310

- Expands the Capabilities of OEM #27023 Ball Joint Press
- For Working on Many GM, Ford and Chrysler 2WD and 4WD Pickups, Vans and SUVs
- Includes: 8 Receiving Tubes, 2 Installing Tubes, 2 Receiving Cups, 1 Plug and 1 Remover/Installer
- Comes in a Sturdy Blow Mold Case

Spindle Locknut Wrench Kit

SKU 695087 **110⁹⁹**
33627174

- Ideal for 4 Wheel Drive Axle Retainers
- Use with Many 1/2 Ton Vehicles with Dana 44 Series Axles and with Many 3/4 Ton Vehicles with Dana 70 Series Axles

Ball/U-Joint Press with 4WD Adapter Set

SKU 695584 **109⁹⁹**
33627089

- 1967 to Current 1/2 to 3/4 Ton 4WD
- Dana 44 Series Front Axle Adapter Sets Available: #27163, #27164, #27165 and #27166

Ball Joint Intermediate Service Kit

SKU 087302 **349⁹⁹**
OTC6530

- This Kit is a Combination of 7249, 7918, and 7996 Kits, and Includes 20+ Adapters, C-Frame, and Application Diagrams All Provided in a Case

Axle Tools

FWD Axle Puller Adapter

SKU 695592 **20⁹⁹**
33627058

- Used to Pull CV Drive Axles from the Transmission of Front Wheel Drive Cars
- Use with OEMTOOLS™ #27033 and #33627033 Slide Hammer

Front Wheel Drive Hub Puller

SKU 695606 **25⁹⁹**
33627037

- Fits Most Domestic and Import Vehicles with Independent Front Wheel Suspension
- Yoke and Bolt are Threaded 5/8" x 18

Axle Puller

SKU 695612 **25⁹⁹**
33627032

- Use with OEMTOOLS™ Slide Hammer (#27033 and #33627033) to Pull Flange Type Axle on Most Domestic Cars and Trucks with 4-1/2" or 5-1/2" Bolt Circles

4WD Spindle Puller Attachment

SKU 695583 **35⁹⁹**
33627104

- Use with OEMTOOLS™ Slide Hammer #27033 and #33627033
- Fits Most Spindles 1-1/2", 1-5/8" and 2" on 4WD Vehicles

Bushing Tool

Manual Bushing Installation and Removal Tool Set

SKU 298214 **249⁹⁹**
27212

- Comprehensive Kit for Fast and Effective Removal/Installation of Wheel Bearings/Suspension Bushings and Seals
- Allows the Technician to Service a Wide Range of Bushings without Removing Components from the Vehicle
- Comes with 20 Sleeves for 100's of Combinations
- External Sleeve Diameter: 44, 46, 48, 50, 52, 54, 56, 58, 60, 62, 64, 66, 68, 70, 72, 74, 76, 78, 80, 82 mm

5 Lbs. Slide Puller

SKU 695611 **45⁹⁹**
33627033

- Threaded 5/8" x 18
- Works with OEMTOOLS™ Attachments as Well as Other Manufacturers' Attachments with the Same Thread

Axle Popper™ II

SKU 010119 **44⁹⁹**
STK71415

- Tapered on Both Ends
- Fits in Air Hammer
- Increased Base Size for Additional Strength
- Safer Than a Pry Bar

Rear Axle Bearing Remover Set

SKU 695117 **55⁹⁹**
33627129

- Used to Pull Semi-Floating Rear Axle Bearings
- Use with OEMTOOLS™ #27033 and #33627033 Slide Hammer

Axle Popper Kit (Fork and Shim)

SKU 821450 **87⁹⁹**
33627305

- Strike the Axle Popper Wedge or Use it as a Pry Bar to Remove the Half Shaft
- Shim Included to Fill the Gap on Some Vehicles

Rear Axle Puller Set

SKU 094801 **89⁹⁹**
27202

- Use for Flange-Type Rear Axle and Bearing Removal on Most Late Model Passenger Cars and Light-Trucks

Axle Spindle Threading Set

SKU 514007 **59⁹⁹**
27233

- Set Includes: M20 x 1.25, M20 x 1.50, M22 x 1.00, M22 x 1.50, M24 x 1.50, M24 x 2.00, 13/16" x 20 UNEF, 3/4" x 20 UNEF and 27 mm Extension Bar

Impact Socket

1/2" (12 mm) Ford Drive Line Impact Socket

SKU 420319 **17⁹⁹**
24212

- Applications Include Many Ford Drive Line Bolts
- 12 mm, 12 Point

SERVICE TOOLS

Harmonic Balancer

Harmonic Balancer Remover

SKU 596957 **149⁹⁹**
GGT180

- Time Saving Harmonic Balancer Puller
- Clip-in Compact Design (No Bolts Required)
- Suitable for: GM, 5.3L, 5.7LS1, 6.0LS2, 6.2LS3, 7.0L
- Also Fits: Chrysler/Dodge/Jeep 3.5L & 3.6L V6s and 4.7L, 5.7L, & 6.1L V8s
- Radiator Removal Not Required



GM Harmonic Balancer Puller

SKU OUTSIDE BUY/EPO 25264

119⁹⁹

- Designed to Remove Harmonic Balancers without Tapped Holes
- Time Saving Tool - No Need to Remove Radiator
- GM Applications: 5.3 L, 5.7LS1, 6.0 LS2, 6.2 LS3, 7.0 L
- Chrysler/Jeep/Dodge: 3.5 L V6, 3.6L V6, 4.7 L V8, 5.7 L V8, 6.1 L V8

NEW



Available via Outside Buy/EPO,
Call 1-877-298-6651 for Ordering Instructions

Harmonic Balancer Puller

SKU OUTSIDE BUY/EPO LIS45500

39⁹⁹

- Reduces Damage to the Pulley and the Shaft
- Can Also be Used for Steering Wheel Removal



Available via Outside Buy/EPO,
Call 1-877-298-6651 for Ordering Instructions

Long Reach Harmonic Balancer Pulley Installer

SKU 544785 **36⁹⁹**
24442

- Install Crank Pulley on Many Late Model Ford, GM, Dodge and Chrysler Vehicles with V8 and V6 Engines
- Includes: M16x2.0 - GM; M14x1.5 - Dodge, Chrysler, Jeep; M12x1.75 - Dodge, Chrysler, Jeep; M112x1.5 - Ford; Nut / Bearing Assembly



Harmonic Balancer/Steering Wheel Puller

SKU 532440 **17⁹⁹**
25053

- Removes Balancers, Steering Wheels, Pulleys and/or Gears with Tapped Holes
- Floating Swivel Helps Prevent Damage to Shaft End
- 4 Slots in Yoke, Use for 2 or 3 Hole Applications with 3/8"-24, 5/16"-18 and 3/8"-16 Bolt Sizes

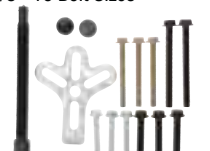

STORE STOCKED

Harmonic Balancer Puller Kit

SKU 818738 **42⁹⁹**
25090

Unique Jaw and Returning Springs for Easy Positioning of the Puller

- Includes: Puller Body, 3 Jaw Puller, (3) Jaw Retaining Pins, (3) Wave Washers, Pressure Screw
- Insert Rods: 4", 5-13/32", 6-1/2" and 7-13/32"
- Used on Many GM, Mitsubishi and Chrysler Engines

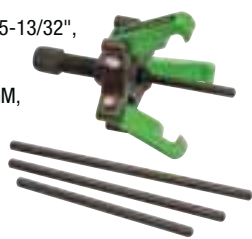

Harmonic Balancer Puller

SKU 695619 **20⁹⁹**
33627019

- Set Includes: Yoke, Pressure Screw, and Pulling Screws
- Floating Swivel Prevents Damage to Shaft Ends
- Comes in a Sturdy Blow Mold Storage Case
- Yoke Features 4 Slots
- Heat-Treated for Strength and Durability



Harmonic Balancer Puller Retrofit Kit for GM

SKU 695100 **14⁹⁹**
33627296

- Use with OEM 33627019, 27019 and 25053 Harmonic Balancer Pullers and Many Other Popular Balancer Pullers
- The 3 Bolts Fit Through the Slotted Holes in the Balancer and Screw into the Threads of the Balancer on GM 3300 and 3800 V6 Engines
- Shoulders on the Bolts Prevent Damage to the Crank Sensor That Can Occur When Using Standard Bolts
- Includes Spacer to Prevent Damage to Crankshaft and Threads



Harmonic Balancer Installer

SKU 695105 **45⁹⁹**
33627144

- Used to Properly Install Harmonic Balancers
- Includes Adapters: 12mm x 1.5mm, 14mm x 1.5, 16mm x 2.0, 7/16" x 2.0, 1/2" x 2.0, 9/16" x 18, 5/8" x 18, 3/4" x 16



Honda/Acura Crankshaft Damper Holding Tool

SKU 217379 **29⁹⁹**
27176

- Holds Crankshaft Damper when Tightening/Loosening Crankshaft Bolt on Honda and Acura Engines 1990-Present



Alternator

Alternator Decoupler Pulley Tool Kit

SKU 300124 **18⁹⁹**
27261

- Set Works on Both Overriding Alternator Decoupler (OAD) and One-Way Clutch (OWC) Pulleys
- Tools May Be Used While the Alternator is On or Off the Vehicle
- Comes in a Blow Mold Case



Alternator Decoupler Pulley Service Kit

SKU 695085 **64⁹⁹**
33627275

- Allows Alternator Shaft to Be Held While the Pulley Retainer is Removed
- Includes a Special Set of Spline and Star Socket Bits for Removal of Bosch Type Alternator Free-Wheel Drive Pulleys



Socket Press

C-Frame Socket Press Set

SKU 012659 **189⁹⁹**
24537

- For the Installation and Removal of Driveline and Non-Driveline Parts
- Any Socket with 1/4", 3/8" or 1/2" Drive Can be used in any Combination for the Use on Virtually all Cars, ATV/UTV/SxS, Light-duty Trucks and Farm Machinery
- Set Includes Flat Anvil Attachments for General Pressing Jobs



Specialty Pullers

Steering Wheel and Lock Plate Puller Kit

SKU 900821 **34⁹⁹**
27182

- Use to Pull Steering Wheels on Many Major Makes of Automobiles
- Includes Yoke, Pressure Screw and Five Sets of Pulling Screws with Washers and Swivel



Power Steering Pulley Puller/Installer Kit

SKU 141495 **32⁹⁹**
25298

- Fits Pulleys with Hub Diameters Measuring 1-1/8", 1-1/4", 1-5/16" and 1-3/8"



Steering Wheel Puller Leg Kit

SKU 793567 **10⁹⁹**
33627312

- Useful During Steering Wheel Removal When There are No Tapped Holes in the Assembly
- For Pontiac Lemans; Newer GM Cars, Subs, Light Trucks; Newer Ford Subs and Light Trucks; Newer Jeep Grand Cherokee; Newer Jeep Liberty; Newer Dodge Sprinter Van
- Use with OEM Steering Wheel Puller #27017 and Other Popular Steering Wheel Pullers to Expand Coverage



Steering Wheel Lock Plate Remover

SKU 070115 **14⁹⁹**
25134

- For Easy Removal and Installation of Lock Plate Snap Rings When Servicing Steering Wheel Column



STORE STOCKED

Steering Pivot Pin Remover

SKU 265106 **8⁹⁹**
25135

- Works on 1969 to Current GM, Chrysler and Ford Vehicles with Saginaw Steering Columns



Universal Steering Knuckle Spreader Tool

SKU 512957 **59⁹⁹**
27234

- Spreads Lower Ball Joint, Preventing Damage to Knuckle



Power Steering Pulley Puller

SKU 070129 **12⁹⁹**
25190

- Removes Pressed-on Pulleys From Alternators and Power Steering Pumps



Power Steering Pump Pulley Service Set

SKU OUTSIDE BUY/EPO OTC4530 **51⁹⁹**

- Fits Pulley Hubs with Diameters of 1-1/8", 1-1/4", 1-5/16" and 1-3/8"

Available via Outside Buy/EPO,
Call 1-877-298-6651 for Ordering Instructions



Steering Wheel Puller

SKU OUTSIDE BUY/EPO LIS45000 **25⁹⁹**

- Screw Pad Protects End of Steering Shaft
- For Most Makes and Models

Available via Outside Buy/EPO,
Call 1-877-298-6651 for Ordering Instructions



Steering Wheel Lock Plate Tool

SKU OUTSIDE BUY/EPO LIS57340 **25⁹⁹**

- Fits Domestic Lock Plates - Tilt and Telescoping

Available via Outside Buy/EPO,
Call 1-877-298-6651 for Ordering Instructions



Power Steering

Universal Air Bleed Adapter

SKU 751699 **25⁹⁹**
MITMVA660

- Helps Remove Trapped Air in the Power Steering System
- Rubber, Cone-Shaped Design
- Seals Pump Necks Ranging from 5/8" Up to 1-5/8" (16 to 41 mm) Internal Diameter
- Works with a Hand Vacuum Pump



Air Bleed Adapter for Ford

SKU 751704 **34⁹⁹**
MITMVA662

- Helps Remove Trapped Air in the Power Steering System
- Seals Ford Power Steering Pump Necks Having an Internal Diameter of 1-1/4" or 2" (32 or 50 mm)
- Works with a Hand Vacuum Pump



Air Bleed Adapter for GM

SKU 751698 **34⁹⁹**
MITMVA661

- Helps Remove Trapped Air in the Power Steering System
- Designed for Sealing GM Power Steering Pumps with a Two-Tab Cap Design
- Works with a Hand Vacuum Pump



Power Steering Adapter Kit

SKU 752069 **69⁹⁹**
MITMVA670

- Helps Remove Trapped Air in the Power Steering System
- Works with a Hand Vacuum Pump
- Includes the MITMVA660, MITMVA661, and MITMVA662



Power Steering Vacuum Pump

SKU 463254 **159⁹⁹**
THX212

- Bleeds Trapped Air from Power Steering System
- Tapered Adapter Allows Use on Most Makes and Models



Power Steering Bleeder Kit

SKU 434716 **22⁹⁹**
27311

- **Reduce Comebacks**
- Eliminates Trapped Air in Power Steering and Brake Systems Following Repairs or Fluid Changes
- Includes 2 EPDM Tapered Rubber Adapters to Fit Most Power Steering Pumps and Reservoirs, Reservoir Bottle to Protect Hand Vacuum Pumps and 3 Sizes of Brake Bleeder Adapters
- Works with a Hand Vacuum Pump



Slide Hammer Pullers

9 Way Slide Hammer Puller Set

- SKU 900825 **99⁹⁹**
 27191
- Pulls Flange-Type Rear Axles and Most Front Wheel Drive Hubs
 - Internal and External Jaws Provide a Variety of Combinations to Pull Bearings, Gears and Seals
 - Two- and Three-Way Cross Blocks
 - Includes a Grip Wrench Adapter and a Dent Puller Attachment
 - Designed for Use with Other 5/8" - 18 Thread Slide Hammer Attachments

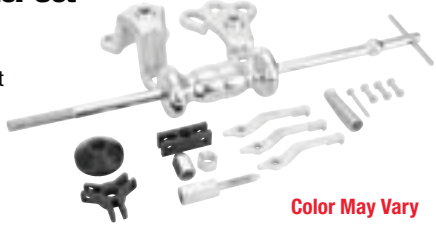

Color May Vary

Blind Hole Puller Set

- SKU 695118 **129⁹⁹**
 33627128
- Pull Blind Hole Bearings, Bushings and Sleeves with Inside Diameters 3/8" - 1-3/8"



5 Lb. Slide Hammer

- SKU 002047 **45⁰⁰**
 27033
- For a Variety of Pulling Tasks
 - Chrome Plated Main Shaft
 - Thread: 5/8" x 18



STORE STOCKED

Pilot Bearing Puller Attachment

- SKU 230517 **15⁰⁰**
 27059
- Use with Slide Hammer OEM# #27033



STORE STOCKED

Pullers

4" 2/3 Jaw Puller

- SKU 246387 **25⁹⁹**
 25903
- Standard Jaw Puller Made with Hi-alloy Steel
 - Jaws Grip Tighter as Pressure is Applied
 - Adjustable and Reversible Jaws with 2 and 3 Jaw Configuration
 - 4" Spread



2/3 Jaw 2 Ton Gear Puller

- SKU 070134 **34⁹⁹**
 25901
- Maximum Reach: 3-1/2"
 - Maximum Spread: 4-3/4"
 - Center Forcing Screw: 3/8" - 24" x 4-7/8"



STORE STOCKED

2 Jaw 5 Ton Gear Puller

- SKU 141513 **29⁹⁹**
 25914
- Reversible
 - Maximum Reach: 3-1/4"
 - Maximum Spread: 6"



STORE STOCKED

2/3 Jaw 5 Ton Long Arm Puller

- SKU 231202 **39⁹⁹**
 25919
- Reversible
 - Maximum Reach 5-1/2"
 - Maximum Spread 7"



STORE STOCKED

Bearing and Pulley Puller Set

- SKU 900824 **89⁹⁹**
 27190
- Makes Up to Eighteen Different Pullers!
- Use on Pitman Arms, Timing Gears, Carrier Side Bearings, Crankshaft Pulleys and More



U-Joint Tools

Automotive U-Joint Puller

- SKU 949561 **89⁹⁹**
 24539
- Easily Removes Seized U-Joint Cups on Most Passenger Vehicles and Light-Duty Trucks
 - Does Not Damage the Driveshaft, Yokes, Joints or Bearing Cups
 - Bearing Cup Outside Diameter: 1" to 1.25"



Intermediate

- SKU 949565 **109⁹⁹**
 24548
- Bearing Cup Outside Diameter: 1.25" to 1.7"

Heavy Duty

- SKU 041474 **149⁹⁹**
 24538
- Bearing Cup Outside Diameter: 1.5" to 2.2"

Automotive Bearing Cup Installer

- SKU 949571 **59⁹⁹**
 24549
- For the Installation of Bearing Cups on Light- and Medium-Duty U-Joints
 - Efficiently Install (2) Bearing Cups in One Process
 - Contact Points Feature Magnets to Retain Bearing Cups During Operation
 - Prevents Damage to Aluminum Drive Shaft



Tubing

Mini Tubing Cutter

- SKU 532507 **8⁹⁹**
 25058
- Capacity: 1/8" to 7/8"
 - Cutter is Capable of Turning on a 1-7/8" Radius
 - Lightweight for Easy Handling



STORE STOCKED

Multi-Purpose Tubing Bender

- SKU 390889 **7⁹⁹**
 25179
- Works on 1/4", 5/16" and 3/8" (4, 6, and 8 mm) O.D. Copper, Aluminum and Stainless Steel Tubing
 - Used to Make Left, Right and Offset Bends Up to 90 Degrees



Tubing Cutter

- SKU 141489 **7⁹⁹**
 25299
- Cuts Tubes Capacity: 1/8" to 1-1/8"
 - Die Cast Frame with Reamer
 - Alloy Steel Cutting Wheel
 - Large, Easy Grip Knob with 1/8" to 1-1/8" Two Facing Flare Groove Rollers



STORE STOCKED

Exhaust Tools

Manifold Drill Template Ford 2V and 3V

- SKU OUTSIDE BUY/EPO **69⁹⁹**
 25251
- Designed to Remove Broken Exhaust Manifold Studs
 - For Ford Triton 2V and 3V Engines - 4.6L, 5.4L and 6.8L V10
 - Interchangeable 2V and 3V Adapters
 - Hi-Vis EVA Tray for Easy Storage and Organization



1-1/2" x 2-7/16" Tailpipe Expander

- SKU 695615 **17⁹⁹**
 33627027

2-1/8" x 3-7/16" Tailpipe Expander

- SKU 695614 **19⁹⁹**
 33627028

- Expands Tailpipes So Mufflers and Tailpipes Can Be Fitted to the Exhaust System



Exhaust Manifold Spreader Set

- SKU 504028 **18⁹⁹**
 25253TWO
- Used for Reinstalling the Manifold on Small-Block Chevrolets
 - Simple Way to Expand Warped Manifold to Align Bolt Holes
 - Helps Prevent Cross-Threading of Manifold Bolts
 - Works Best When Used in Pairs or Install Before Removing Manifold to Prevent Misalignment



Fuel Pump

Fuel Pump Module Spanner Wrench

- SKU 110278 **19⁹⁹**
 25156
- Removes and Installs the Fuel Pump Retaining Ring



Fuel Tank Lock Ring Tool

- SKU 751721 **44⁹⁹**
 24398
- For 2004 - Newer Ford F150 Trucks; 2004 or Newer Chrysler/Dodge Mini-Vans, PT Cruiser, Dakota, Durango; 2004-Newer Chevy 1/2 Ton and 3/4 Ton Trucks
 - Works with 1/2" Drive Ratchet or Breaker Bar



Pipe Stretcher Kit

- SKU 080137 **269⁹⁹**
 LIS17350
- Expands All Types of Exhaust Pipe, Including Stainless Steel, from 1-5/8" to 4-1/4" in Size
 - Use with Impact Wrench to Quickly Stretch Pipes



Specialty Sockets

Water Sensor Wrench

- SKU 459099 **12⁹⁹**
 LIS34900
- Removes and Installs the Water Sensor Located on the Fuel Filter on 2012 and Newer 6.6L Duramax Diesel Engines



Water Sensor Wrench Fits Aftermarket Sensors

- SKU 459101 **12⁹⁹**
 LIS34910
- Removes and Installs the Aftermarket Water Sensor Located on the Fuel Filter on 2001 - 2011 6.6L Duramax Diesel Engines



3/8" Drive Oxygen Sensor Socket

- SKU 047738 **12⁹⁹**
 25001
- For Use with 3/8" Drive Ratchet or 1" Wrench
 - Removes and Installs Oxygen Sensors on All Domestic and Imported Computerized Engine Controlled Vehicles
 - Cutaway Slot Provided in the Side for Sensor Wire Clearance
 - Durable Alloy Steel Construction



STORE STOCKED

7 Piece Sensor Socket Set

- SKU 900823 **49⁹⁹**
 27189
- For Removal and Installation of Hard to Reach Oxygen Sensors, Oil Pressure Switches, Oil Pressure Sending Units and Thermal Sensor Switches



Oxygen Sensor Wrench

- SKU 947305 **29⁹⁹**
 33625246
- Use with Oxygen Sensors on Ford 4.6 and 5.4 Engines
 - 7/8" / 22 mm Used in SUVs and Light Trucks



STORE STOCKED

Oxygen Sensor Socket Set

- SKU 695125 **25⁹⁹**
 33627110
- Universal Slotted Socket to Service Hex Vacuum Switches and Oxygen Sensors
 - 3/8" and 1/2" Drive, 22 mm / 7/8"



Ford Ignition Module Wrench

- SKU 002362 **5⁹⁹**
 25013
- For Removal of 7/32" Hex Head Bolts or T-20 Star Drive Head Bolts



STORE STOCKED

Oil Pressure Switch Socket

- SKU 141490 **11⁹⁹**
 25254
- Fits Most 1" and 1-1/16" Switches
 - Accepts Oil Pressure Sending Units Up to 2-5/8" Long



STORE STOCKED

GM Water Pump Socket

- SKU 693857 **30⁹⁹**
 33627109
- Works on 1993-Newer Cadillac Northstar 4.6L V8 Engine (1993-newer) and Oldsmobile Aurora 4.0L L47 V8 (1995-1999)
 - 1/2" Drive



STORE STOCKED

IPR Socket

- SKU 912334 **14⁹⁹**
 25280
- Remove / Replace IPR Without Damaging the Connector
 - Applications: Ford 6.0 L and Other Diesel Engines
 - 3/8" Drive



STORE STOCKED

SERVICE TOOLS

Flaring Tools



Double Flaring Tool

SKU 864647
25358 **21⁹⁹**

- Includes Five Adapters: 3/16", 1/4", 5/16", 3/8" and 1/2" (4.8 mm Through 12.7 mm)



In-Line Flaring Tool Kit

SKU 238197
24364 **24⁹⁹**

Create a Perfect Flare Every Time!

- Use on Thin-Walled Steel and Copper Tubing
- Low Profile Design Allows for Use On or Off the Vehicle
- 3/16" and 4.75 mm Tubing
- Double Clamp and Hex Screw Keeps Tubing Locked Tightly in Position



Double Flaring Tool

SKU 695622
33627015 **30⁹⁹**

- Produces Single and Double Flares in Soft Steel

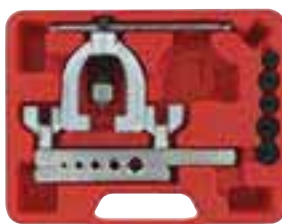

Refractometers



UREA DEF Refractometer

SKU 471112
OTC5025 **99⁹⁹**

- Def-Unique Calibrated Scale with 32.5%
- Enables Operators to Clearly Determine if the Def in Their Vehicle Consists of a 32.5% Urea / Water Solution
- 15-40% Variance on Scale
- 0.5% Line Graduations
- Complete Kit Provides Operators Everything They Need to Calibrate and Use Def Refractometer



STORE STOCKED

Bubble Flaring Tool Kit

SKU 592261
27214 **29⁹⁹**

- Designed for Metric Soft Steel Brake Lines Where an "ISO" or Bubble Style Flare is Required
- Flaring Bar and All the Adapters Needed for ISO Bubble Flaring
- Includes Four Dies 4.75, 6, 8, and 10 mm



Die and Adapter Flare for GM Transmission Cooling Line

SKU 300785
MSC71099-TC **49⁹⁹**

- Die and Adapter Flare for GM Transmission Cooling Line



Universal Hydraulic Flaring Tool Set

SKU 032798
MSC72485 **399⁹⁹**

- Fabricates 1/4", 5/16" and 3/8" Push Connect
- Flare/Double Flare: 3/16", 1/4", 5/16", 3/8" and 1/2"
- Metric Bubble Flare: 4.75, 6, 8 and 10 mm
- Includes GM Fuel Line and Transmission Cooling Line Flares



Disconnect Tools



Fuel Line Disconnect Tool

SKU 246367
25043 **7⁹⁹**

- Fits Any 5/16" or 3/8" Fuel Line Found on GM, Ford and Chrysler Vehicles



A/C and Fuel Line Disconnect Tool Set

SKU 246366
25042 **7⁹⁹**

- Range: A (3/4"), B (5/8"), C (1/2") and D (3/8")



Over-Tank Fuel Pump Disconnect Set

SKU 695115
33627131 **16⁹⁹**

- Provides Easy Access to Hard to Reach Fuel Line Quick Connectors Found Under the ABS Unit on '92 and Newer GM "W" Body Cars
- Red Tool Fits 5/16" Return Lines; Blue Tool Fits 3/8" Fuel Inlet Lines
- Also Works on 1988 and Newer Ford F-Series Pickups to Disconnect the Fuel Lines from the Fuel Sending Unit



Fuel Module Disconnect

SKU 291418
LIS37500 **8⁹⁹**

- Fits Both 3/8" and 5/16" Connectors and Applications
- Tool Can Be Clipped Together for Convenient Storage



AC/Fuel Line Disconnect Tool Set

SKU 222520
LIS37000 **9⁹⁹**

- Set Includes 6 Sizes: 5/16", 3/8", 1/2", 5/8", 3/4" and 7/8"



STORE STOCKED

STORE STOCKED

Fuel and AC Disconnect Pliers

SKU 343391
LIS37300 **27⁹⁹**

- Unique Design Provides Extra Leverage When Disconnecting Quick Connect Coupling Air Conditioning and Fuel Lines



A/C and Fuel Line Quick Connect Tools

SKU 002356
25052 **9⁹⁹**

- Easily Disconnects Air Conditioning Lines and Quick Connect Fuel Lines

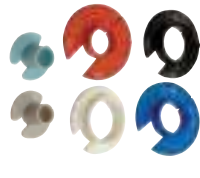

3 Piece 1/2" Oil Line Disconnect Set

SKU 094653
25187 **19⁹⁹**

- Used to Remove and Replace Oil and Transmission Cooler Lines on GM, Ford, Nissan and Toyota



Coolant Hose Removal Tool Set

SKU 383214
CAL244TNZ **29⁹⁹**

- Used to Completely Fill the Void in the Connector to Release the Fastener
- 40° Offset Designed for Jobs Up Against the Firewall or in Tight Spaces



Quick Connect Tools

SKU 363869
25184 **12⁹⁹**

- Sizes: 3/8", 1/2", 5/8" and 3/4"
- Enables Quick and Easy Disconnect of Air Conditioning Couplings



Heater Hose Disconnect Tool

SKU 695607
33627106 **14⁹⁹**

- Removes Heater Hoses with 1/4" or 5/8" Quick Disconnect Couplings on '86 to Current Ford Aerostar Vans and '01s to Current Full Size Ford Vans
- Works on Rear Heater Hose Couplings on '87 to Current Chrysler and Plymouth



NAVISTAR® MAXXFORCE® Fuel Line Disconnect Tool Set - 4 Piece

SKU 004112
25031 **34⁹⁹**

- 4 Piece Disconnect Tool Set for Navistar® MaxxForce® Series 11 and 13 Engines
- Sized to Depress Fuel Release Tabs for Efficient Fuel Line Removal
- (1) Straight and (1) 90° Tool for 11.8 mm Fuel Lines;
- (1) Straight and (1) 90° Tool for 16 mm Fuel Lines



Ford Clutch Disconnect Tool

SKU 695116
33627130 **6⁹⁹**

- Works on 1988 to Present Ford Vehicles and Light-Trucks with Hydraulic Clutches



4 Piece Disconnect Set

SKU 864648
25150 **19⁹⁹**

- Sizes: 1/4", 5/16", 3/8" and 1/2"



4 Piece Disconnect Set

SKU 948999
25183 **24⁹⁹**

- Includes: 1/2", 5/8", 3/4" and 7/8"



6 Piece Disconnect Set

SKU 013603
24681 **19⁹⁹**

- Oil Cooler Line Disconnect Tool Separates Automatic Transmission Oil Cooler Lines on Ford Taurus and Escort with AXPD and ATX Transmissions
- Unique Offset Design Allows for Access in Confined or Obstructed Areas
- Sizes: 5/16", 3/8", 1/2", 5/8", 3/4", and 7/8"



Low Profile Jiffy-Tite® Disconnect

SKU 011609
LIS22990 **69⁹⁹**

- Disengages Jiffy-Tite Quick-Connect Fittings
- No Need to Remove Retaining Clips
- Includes Four Sizes: 3/8", 1/2", 5/8"-30% and 5/8"-39%



Angled Disconnect Set

SKU 291416
LIS39400 **19⁹⁹**

- Disconnects Spring Lock Couplings on Ford and Chrysler A/C Lines
- Works on Fuel Lines and Other Quick Disconnect Couplings on Domestic and Import Vehicles
- 6 Sizes: 5/16", 3/8", 1/2", 5/8", 3/4" and 7/8"



Master Disconnect Sets



15 Piece Master Disconnect Set

SKU 900807
27195 **27⁹⁹**

- Includes Fuel and Transmission Line Disconnect Set, Oil Cooler Line Remover, Air Conditioning and Fuel Line Disconnect Tool



Master Disconnect Set

SKU 821445
33627318 **90⁰⁰**

- Easily Disconnects A/C Lines, Fuel Lines and Transmission Cooler Lines
- Includes: Hydraulic Clutch Line Disconnect for GM, 5/16" and 3/8" Fuel Line Retaining Clips for GM, Air Conditioning/Fuel Line
- Disconnects: 5/16", 3/8", 1/2", 5/8", 3/4", and 7/8"
- Scissor Disconnects: 5/16", 3/8" and 1/2", 3/8"
- Ford: Fuel Line, Oil Cooler Line and Clutch Coupling Remover
- Coupler Disconnects



Master Disconnect Tool Set

SKU 291413
LIS39900 **59⁹⁹**

- Contains 8 Tools for A/C and Fuel Lines
- Comes in a Blow Mold Case





FREE OVERNIGHT SHIPPING
WITH MOST ORDERS
SEE PAGE 3 FOR DETAILS

OEM TOOLS TORQUE WRENCHES

1/2" Drive 10-150 Ft/Lbs. Torque Wrench

SKU 012651 25689 **39⁹⁹**

- Click-Style Torque Wrench Produces Audible Click at the Preset Torque
- High-Visibility Scale Features Ft/Lbs. and Nm Measurements
- Steel Construction with Durable Green Coating
- Reversible Ratchet Head

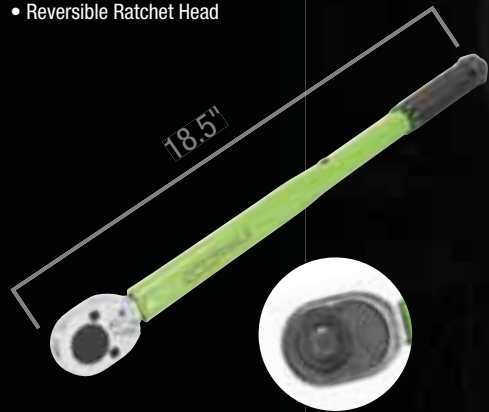

1/2" Drive Torque Wrench 20-250 Ft/Lbs. Range

SKU 177715 25695 **62⁹⁹**

3/8" Drive Torque Wrench 10-80 Ft/Lbs. Range

SKU 177722 25694 **35⁹⁹**

- 24 Tooth Ratchet
- Accuracy: +/-4%

3/8" Drive Torque Wrench 25-250 In/Lbs. Range

SKU 133657 25685 **29⁹⁹**

- 45 Tooth Round Head Ratchet
- Audible Click When Desired Torque is Reached
- Both Clockwise and Counterclockwise Operation

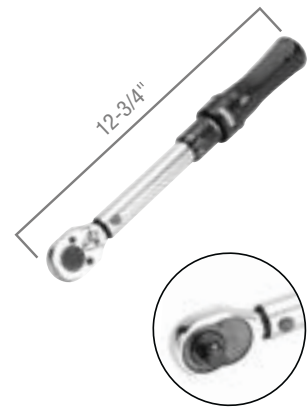

3/4" Drive Professional Micrometer Torque Wrench 80-400 Ft/Lbs. Range

SKU 850046 33627309 **349⁹⁹**

- Range: 86-400 Ft/Lbs.
- Torques in Both Directions
- Positive Lock with Spring-Loaded Pull Down Lock Ring



Great for 2004-2008 Ford F150 Brake Rotor and Hub Assembly Replacement

3/4" Drive Professional Micrometer Torque Wrench 100-600 Ft/Lbs. Range

SKU 217376 25688 **279⁹⁹**

- Micrometer Click Style
- Right Hand Direction



Torque Multipliers

OEM TOOLS™

3/4" Drive Torque Multiplier

SKU 191056 25683 **229⁹⁹**

- Converts Low Torque (Max. 650 Ft/Lbs.) to High Torque (2,200 Ft/Lbs. / 3,000 Nm) with Planetary Gear Set for Heavy Duty Tightening and Loosening
- Input Drive: 3/4", Output Drive 1"
- Comes with a 3/4" Drive 2 Way Quick Release Ratchet



Torque Screwdriver

OEM TOOLS™

1/4" Drive Torque Screwdriver

SKU 695088 33627172 **59⁹⁹** REG. 79.99

25-250 Ft/Lbs. Range

- Range: 10 - 50 In/Lbs.
- Great for Low Torque Applications
- Easy-to-Read Window Scale



SAVE \$20

Offer Good Through March 31, 2019 While Supplies Last

Torque Adapters

OEM TOOLS™

3/8" Drive Digital Torque Adapter

SKU 362559 25684 **49⁹⁹**

- Range 27 - 135 Nm (238.9-1,194.8 In/Lbs.)

Turn Any Ratchet or Breaker Bar into a Digital Torque Wrench!



1/2" Drive Digital Torque Adapter

SKU 900805 25682 **49⁹⁹**

- Range 40 - 200 Nm (29.5-147.5 Ft/Lbs.)
- Buzzes When Target Torque is Reached



Measuring Tools

OEM TOOLS™

Feeler Gauge

SKU 001927 25025 **6⁹⁹**

- 26 Blades Laser Etched with SAE and Metric Sizes



STORE STOCKED

24" Straight Edge

SKU 949552 25355 **25⁹⁹**

- Constructed 1/4" Thick Cold Rolled Steel
- Durable Powder Coat Finish with Precision Ground Edge
- Hang Hole for Convenient Storage
- Includes Reusable Protective Edge



Dial Indicator Set

SKU 186500 FOW72522101 **84⁹⁹**

- Includes 1" Indicator, Magnetic Base, Plus Rods, Swivel Clamp and Case
- 2-1/4" Dial, .001" Increments

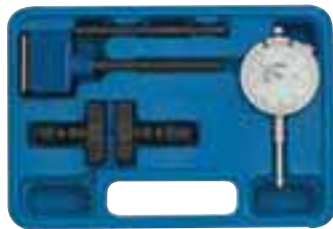

Mini MAG Protractor

SKU 186501 FOW744224501 **94⁹⁹**

- Embedded Magnets with 35 Lbs. Pull
- Uses Standard 9V Battery
- 360 Degree Measuring Range
- Accuracy ±0.2 Degrees



3 Piece Micrometer Set

SKU 186503 CEN3M113 **129⁹⁹**

- 0 to 3" Range
- 3m101: 0 - 1"
- 3m102: 1 to 2"
- 3m103: 2 to 3"
- Set Includes Calibration Tools



Specialty Measuring Tools

OEM TOOLS™

6" Digital Caliper

SKU 013642 24680 **12⁹⁹**

- Easy-to-Read LED Display
- 0-6 In. Range (0-150 mm)
- Zeroing Feature



STORE STOCKED

X-Tread® Digital Tire Gauge

SKU 186495 FOW74225500 **29⁹⁹**

- For Tire Tread Thickness Measurement
- Reads in Inch, Metric and Fractions



RotoCal® with Twin Conical Anvils

SKU 186492 FOW74150004 **89⁹⁹**

- Range 0 to 5.5"
- Reads in Inch, Metric and Fractions
- 3.5" Jaw Depth for Large Rotors



Rotor/Drum Measuring Kit

SKU 186504 CEN3K301 **64⁹⁹**

- Attaches to Any Caliper on the Lower Jaws
- Outward Facing Anvils to Inspect Drums
- Inward Pointing Anvils to Measure Rotors
- 8" to 13" Range
- 0 to 6" Digital Caliper Included



Disc Brake/Ball Joint Gauge

SKU 186496 FOW72520757 **114⁹⁹**

- Checks Ball Joint Wear and Disc Rotor Run-Out
- Checks Gear Backlash and Valve Guide Wear
- 0 to 1" Travel and .001" Graduations



ENGINE SERVICE TOOLS

Cam/Crankshaft Tools

Crank Bolt Socket Set 6 Piece

- SKU 919501 25276 **89⁹⁹**
- Set Includes: 17, 19, 21, 22, 26 and 27 mm
 - Heavy Duty Impact Grade Socket
 - Provides Increased Torque to Break Loose Stubborn Crank Bolt Sockets
 - Constructed with Durable Chrome Molybdenum
 - 1/2" Drive



Crank Bolt Sockets

- | | | |
|---|---|---|
| 17 mm
SKU 912348 25275 15⁹⁹ | 21 mm
SKU 912343 25273 15⁹⁹ | 26 mm
SKU 919500 25278 15⁹⁹ |
| 19 mm
SKU 919499 25274 15⁹⁹ | 22 mm
SKU 919496 25277 15⁹⁹ | 27 mm
SKU 919497 25279 15⁹⁹ |

5 Piece Master Cam Clamp™ Kit

- SKU 383452 27210 **59⁹⁹**
- Covers Most Single, Twin Cam and Quad Cam Engines
 - Locks Camshaft to Hold Valve Timing During Timing Belt Replacement



2 Piece Cam Clamp™ Set

- SKU 238159 24360 **24⁹⁹**



Timing Gear Holder

- SKU 544797 24387 **29⁹⁹**
- Holds the Timing Gear in Place During Removal and Installation and Prevents it from Moving While the Retaining Bolt is Removed
 - Allows the Cam Gear to Rotate to Align Valve Timing Marks
 - Single Lever Locking Design is Easy to Use



Honda Crankshaft Pulley Holding Tool

- SKU 217379 27176 **29⁹⁹**
- Holds Crankshaft Damper When Tightening/Loosening Crankshaft Bolt on Honda and Acura Engines 1990 to Present



Universal Camshaft Bearing Tool

- SKU 191677 27143 **179⁹⁹**
- Removes or Inserts Camshaft Bearings in Nearly All Engines
 - Easy on Bearings
 - Range: 1.125" to 2.69"
 - Set Includes: Driving Shaft, Driving Shaft Extension, Expander Unit, (5) Split Driving Plugs, (2) Driving Collars and Centering Cone



Camshaft and Crankshaft Seal Tool Kit

- SKU 544799 24386 **99⁹⁹**
- Easily Removes and Installs Camshaft and Crankshaft Seals
 - Compact Puller with Unique Extracting Hooks Engage Seal for Quick Removal
 - Interchangeable Sleeves and Mandrels Allow Easy Installation of New Seal
 - Suits Seals from 21.5 mm - 64 mm
 - Sleeves and Mandrels Made from High Strength Fiber Glass Reinforced Polymer



Ford Cam Phaser Noise Repair Kit 4.6/5.4 3V

- SKU 494959 LMEF1503V **699⁹⁹**
- Prevents and Corrects Common Failure Point in 2004-2014 4.6 and 5.4 3V V8 Ford Vehicles
 - Eliminates Cam Phaser Knock
 - Simple in Design and Requires No Special Tools to Install
 - Included Wedge Tool Simplifies Phaser Removal and Securely Holds Chains in Position Simple to Operate Tuner with OBD-II Cable Included
 - *CARB E.O. Pending*

Application List	
2005-2010 Mustang 4.6	2005-2010 F250/350 5.4
2006-2010 Explorer/Mountaineer 4.6	2007-2010 Explorer Sport Trac 4.6
2004-2010 F150 5.4	2005-2014 Expedition (including EL)/Navigator 5.4
2009-2010 F150 4.6 3v	



Ford 2.0L, 2.3L, 2.5L Cam Tool Kit

- SKU 626108 24448 **17⁹⁹**
- Applications: 2.0L DOHC Engines Found in 1994-2003 Ford and Mercury, 2004-2012 2.5L DOHC, 2.3L DOHC 4V and 2.0L DOHC Engines in Ford, Mercury and Mazda, and 2.0L DOHC Engines in 1993-1994 Ford Probe



Universal Pulley and Fan Clutch Holder

- SKU 547013 27281 **54⁹⁹**
- Fits Many Different Fan Clutches, Cam and Crank Pulleys with Slots or Holes
 - Adjustable Diameter: 1-1/2" - 8-5/8"
 - Pin Sizes: 6-10 mm, 8-11 mm, 10-12 mm, 11-16 mm



DOHC Cam Lock Holder

- SKU 291419 LIS36880 **39⁹⁹**
- This Versatile Tool Easily Locks and Holds Both Camshaft Sprockets Firmly in Place
 - Preserves the Engine Timing During Belt or Chain Replacement



Universal Cam Adjuster

- SKU 222524 LIS38220 **39⁹⁹**
- Adjusts to Fit Different Size Cam Sprockets
 - Holds Cam Sprocket in Place When Removing Cam Bolt
 - Works on All Single and Dual Overhead Cam Sprockets with Holes



Belt Service Tools

Serpentine Belt Tool

- SKU 013620 24687 **19⁹⁹**
- Provides Leverage and Clearance to Release the Spring Pressure and Remove the Tensioner Pulley
 - Includes 4 Shallow Sockets, Sizes: 13, 15, 16 and 18 mm; and 1/2" and 3/8" Square Drive Adapters



Serpentine Belt Tool

- SKU 695121 33627115 **24⁹⁹**
- Provides Required Leverage and Clearance to Release Spring Pressure and Remove Tensioner Pulley



Stretch Belt Remover and Installer

- SKU 255866 LIS59370 **22⁹⁹**
- Unique Magnetic Faces Hold the Tool in Place on the Pulley
 - Compact, One-Piece Tool Can Be Used on the Front or Back Side of the Pulley



"Easy On" Stretch Belt Installation Tool

- SKU 227303 24362 **13⁹⁹**
- Allows Stretch Belts to Be Quickly Installed without Damage
 - Accommodates Larger Pulleys Found on Many Vehicles' Serpentine Belt without the Belt Slipping Out of the Tool



Stretch Belt Installation Tool

- SKU 227301 24363 **21⁹⁹**
- Clamping Jaw Allows User to Position Serpentine Belt without the Belt Slipping Out of the Tool
 - Works on Both Large and Small Pulleys



Stretch Belt Mate Kit

- SKU 544729 24388 **5⁹⁹**
- Easily Installs All Stretch Fit Belts



Belt Holding Tool

- SKU 087299 OTC7424 **26⁹⁹**
- Keeps Belt from Falling Off of a Pulley During Belt Installation
 - Universal Design to Fit Most Pulley Styles and Sizes
 - Super Strong Magnet to Hold the Belt Firmly on the Pulley



Fan Clutch Tools

BMW Cooling Fan Wrench Set

- SKU 912340 25100 **19⁹⁹**
- One Tool Holds the Water Pump Pulley in Place, While the 32mm Ultra-Slim Specialty Wrench is Used to Loosen the Radiator Fan Nut
 - 32mm Wrench Features Dipped Rubber Handle for Improved Grip
 - Water Pump Pulley Holder is Outfitted with Multiple Holding Points to Fit a Variety of BMW Vehicles



Ford 4.9 L Fan Clutch Wrench Set

- SKU 002043 27018 **19⁹⁹**
- Services Thermostatic Fan Clutch Assemblies on Ford Vans, Trucks, Light Trucks, and SUVs
 - Set Includes: 1-7/16" (36 mm) and 2-1/4" (57 mm) Wrench Sizes
 - Wrench Length: 14"



Fan Clutch Wrench Set

- SKU 110280 27186 **59⁹⁹**
- Combines OEMTOOLS™ #27108 and OEMTOOLS™ #27141 Into a Master Set
 - Ideal for Removing Fan Clutches from Water Pumps
 - Set Includes: 36, 40, 48, 54, 57, 68, 72, 76 and 83 mm Wrench Sizes



Fan Clutch Service Set for Mercedes-Benz and BMW

- SKU 512958 27224 **129⁹⁹**
- Removes Lock Nuts on Thermo Viscous Fans Found on Mercedes-Benz, BMW and Many Ford Models
 - Includes:
 - (1) Mercedes-Benz Fan Clutch Wrench - 36 mm, 40 mm and 65 mm Opening
 - (1) BMW Fan Clutch Wrench - 32 mm Opening
 - (1) BMW Fan Clutch Holding Wrench - 38 mm and 44.5 mm
 - (1) Mercedes-Benz Fan Clutch Holding Tool

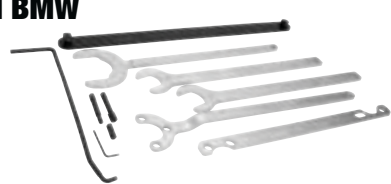

Fan Clutch Holding Tool-GM, Ford, Dodge

- SKU 409637 27270 **80⁹⁹**
- Aids in Changing Fan Clutch by Holding the Pulley
 - Fits Many GM, Ford and Dodge Vehicles



Pneumatic Fan Clutch Wrench Set

- SKU 291409 LIS43300 **179⁹⁹**
- Quickly Removes and Installs Fan Clutch When Repairing the Water Pump or Fan Clutch
 - Set Includes Wrench Sizes: 32, 36, 40 mm; 7/8", 1-7/8" and 2"

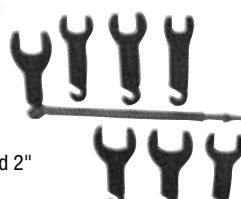

Fuel System Cleaner

Carbon Clean 1000

- SKU 305905 MVC500-0220 **1,309⁹⁹**

- Complete, Through the Rail, Fuel System Decarbonizing Service
- Fuel Rail Hookup Provides the Most Effective Results
- Online Application Guide
- Unique Time Saving Adapter System
- Cleans Fuel Injectors, Combustion Chamber and Intake Valves
- Utilizes the MV5 Proprietary Fuel System Cleaning Chemistry



DID YOU KNOW?

AutoZone® has instrument clusters available.

Contact Your AutoZone Commercial Sales Manager for Details

877-AZTool1
877-298-6651
Hablamos Español
AZtool1.com

Valve Tools

Valve Spring Compressor for 3-Valve Engines

- SKU 814391 24429 **59⁹⁹**
- Designed to Compress the Valve Spring without Removing the Camshaft While Servicing the Cylinder Head in Ford 3-Valve Engines
 - For Use with Ford 3-Valve 4.6L and 5.4L Engines



Ford Valve Spring Compressor

- SKU 626111 24434 **49⁹⁹**
- Applications: 1991-2004 Ford Vehicles with 4.6L, 2V, V8 Engines; 4.6 4V, 5.4 V8 and 6.8 V10
 - Works with Engine Removed or Installed, Cylinder Head On or Off
 - Not for Triton 5.4 3V



Valve Spring Compressor

- SKU 552331 25064 **4⁹⁹**
- Works on GM V8 Engines
 - No Need to Remove Cylinder Heads



Valve Spring Compressor

- SKU 231210 25220 **19⁹⁹**
- Designed for Use on Most Trucks and Cars with Overhead Valves



STORE STOCKED

Hydraulic Valve Lifter Puller

- SKU 695103 33627146 **17⁹⁹**
- Use for Removing Many Valve Lifters from Engine Block



Valve Keeper Remover and Installer Kit

- SKU 011658 LIS36050 **79⁹⁹**
- Makes Valve Component Disassembly and Reassembly Fast and Easy
- For Use with Valve Stems from 4.5 to 7.5 mm and 5/16" to 3/8"
 - Magnet in Tool Body Captures Keepers
 - Works on Toyota 4 Cylinder and Chrysler New World Engine



Push Rod Remover

- SKU 459100 LIS48300 **21⁹⁹**
- Redesigned for Newer 3.5L and 3.6L GM Engines - Also Works on GM V6 2.8L, 3.1L and 3.4L
 - Quickly Removes Push Rods to Replace the Intake Gaskets without Removing Rocker Arms



Piston Tools

Piston Ring Compressor

- Designed with Double Friction Brake Adjustment and Hardened Tool Ratchet
- Constructed of High Grade Spring Steel with 1/4" Square Drive Adjuster
- Beaded Edge Prevents Tool from Entering Cylinder with Pistons



- 3-1/2"-7" **8⁹⁹** 2-1/8" - 5" **8⁹⁹**
- SKU 531947 25039 SKU 531921 25037

Piston Ring Compressor

- SKU 013641 24682 **14⁹⁹**
- 1-1/2" Deep, Low-Friction Wrinkle Band
 - Fits 3" to 5" Pistons



STORE STOCKED

Piston Ring Expander Pliers

- SKU 003509 25083 **17⁹⁹**
- Eliminates Piston Ring Damage and Distortion During the Installation and Removal Process
 - Dipped Rubber Handles for Improved Grip
 - Diameter Range: 3-1/8" (80 mm) to 4-5/8" (120 mm)



Piston Groove Cleaner

- SKU 695604 33627038 **15⁹⁹**
- The Blades are Set in the Wheel Which May Be Rotated to Bring the Desired Blade into Position



Head Bolt Tools

Torque Adaptor, Diesel Head Bolt, Ford 6.0L Power Stroke® Engines

- SKU 298191 24208 **16⁹⁹**
- Prevents Damage to the Rear Heat Shield
 - Use with OEMTOOLS™ 27309 3/4" Drive Torque Wrench and OEMTOOLS™ 22398 18 mm Socket
 - Eliminates the Need to Remove the Evaporator Housing, Saving Time A/C Recharging
 - Eliminates the Need to Remove the Truck/Van Cab to Access the Rear Head Bolts



Flywheel Tools

Duramax Flywheel Lock

- SKU 301613 LIS22100 **49⁹⁹**
- Locks Flywheel in Place When Removing Harmonic Balancer on 6.6L Duramax with Allison Transmissions
 - Saves Time By Locking the Flywheel at the Transmission Instead of Having to Remove the Starter for Water Pump Replacement



Flywheel Turner

- SKU 505066 LIS23800 **36⁹⁹**
- For Turning and Holding Flexplates and Flywheels
 - Easily Turn Engine from Underneath the Vehicle



Spark Plug Sockets

3/8 Drive Magnetic Spark Plug Socket Set- 3pc

- SKU 300140 22891 **19⁹⁹**
- Includes: 5/8", 9/16", and 13/16" Pump Replacement



SPARK PLUG SOCKETS					
Part #	SKU	Drive	Size	Features	Price
22880	082923	3/8"	9/16"	Magnetic	\$5.99
22881	082929	3/8"	18 MM	Magnetic	\$5.99
22882	082931	3/8"	3/4"	Magnetic	\$5.99
22883	082932	3/8"	13/16"	Magnetic	\$5.99
22885	300146	3/8"	5/8"	Magnetic	\$14.99
22886	300147	3/8"	9/16"	6" Extension	\$14.99
22887	825933	3/8"	5/8"	Magnetic	\$5.99
22889	825934	1/2"	13/16"	Magnetic	\$5.99
22895	082936	3/8"	14 MM	Extra Thin Wall	\$5.99

3/8" Drive 14 mm x 12 pt. Spark Plug Socket

- SKU 814164 22814 **9⁹⁹**
- Designed with a Universal Joint for the Installation and Removal of Spark Plugs Situated in Tight Spaces
 - Durable Chrome Moly Steel Construction



3/8" Drive 14 mm x 12 pt. Spark Plug Socket - 1" Extension

- SKU 814337 22813 **12⁹⁹**

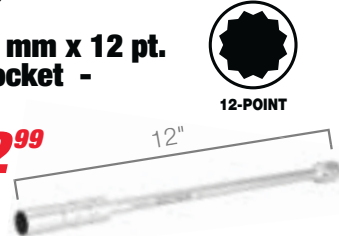

Spark Plug Boot Pliers

- SKU 390900 25542 **9⁹⁹**
- Designed to Remove Hard to Reach Spark Plug Boots
 - Do Not Use When the Engine is Running



Adjustable Spark Plug Wire Puller

- SKU OUTSIDE BUY/EPO LIS51750 **19⁹⁹**
- Adjustable Plier Jaw for Easier Access
 - Cushioned Jaws Grip Straight-On or at an Angle



Available via Outside Buy/EPO, Call 1-877-298-6651 for Ordering Instructions

Spark Plug Wire Puller

- SKU 532549 25061 **3⁹⁹**
- Insulates Hands From Electric Shock. Grips Directly on Boot to Prevent Wire Damage.



STORE STOCKED

Engine Cylinder Hones

Flex-Hone™ BC and Flex-Hone™ GB

- 180 Grit Silicon Carbide with 8" OAL
- ### BC 180SC Flex-Hone Tool Kit
- SKU OUTSIDE BUY/EPO BRM14353 **169⁹⁹**
- 10 Piece Kit Features Flex-Hone Sizes: 10 mm, 1/2", 5/8", 3/4", 7/8", 1", 1-1/4", 1-1/2", 1-3/4" and 2"
 - Complimentary Snap Back Hat, 1/2 Pint of Flex-Hone Oil, and 1GB Flash Drive



Adjustable Engine Cylinder Hone Deglazer

- SKU 532002 25041 **31⁹⁹**
- Range: 2" to 7" (51 mm to 128 mm)
 - Spring Tension Adjusting Nut for Positive Cutting Action at All Speeds
 - Supplied with 4" Medium Grit Stones

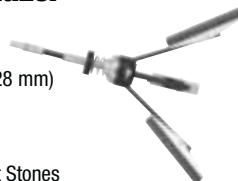

STORE STOCKED

Replacement Stone Sets

- SKU 141540 2541C **11⁹⁹** SKU 532036 2541M **11⁹⁹**
- 3 Coarse Grit (#100)
 - 3 Medium Grit (#220)
- SKU 532044 2541F **9⁹⁹**
- 3 Fine Grit (#400)

STORE STOCKED

Throttle Depressors

Brake - Accelerator Pedal Depressor

- SKU 802194 24232 **29⁹⁹**
- Extends to 24"
 - Suitable for Many Diagnostic Applications



Throttle Pedal Depressor

- SKU 222525 LIS48700 **31⁹⁹**
- Holds Throttle at a Constant RPM
 - Length: 40"

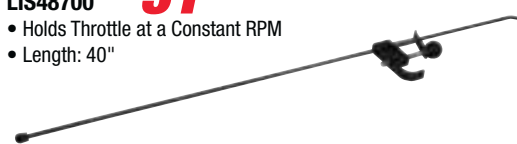

SPECIALTY TOOLS

DID YOU KNOW?

AutoZone® carries bulk packs of mini bulbs and headlight capsules.

Contact Your AutoZone Commercial Sales Manager for Details

Relay Tools

Relay Circuit Tester

SKU 383450
27211 **139⁹⁹**

Cut Relay Related Diagnosis Time By 75 Percent

- Identify at the Push of a Button if a Wire, a Part, or a Relay is Defective
- Test an Entire Circuit from the Battery to the Component
- Bypass Relays to Do Compression Test, Fuel Pressure Test, A/C Fill, etc.
- Kit Includes: Tester, 5 Popular Relay Leads and 1 Universal Relay Lead
- Comes in a Sturdy Blow Mold Case



OEM TOOLS™

Relay Test Jumper Set

SKU 291333
LIS56810 **64⁹⁹**

- Set Includes Four Jumpers to Fit the Most Popular Size Relays on Domestic and Import Vehicles
- Jumpers Have Tabs for Clamping and Flat Pads to Place Test Leads On
- Set Comes in Blow Mold Case for Storage



Relay Test Jumper Set II

SKU 291341
LIS60610 **69⁹⁹**

- Set Includes Four Jumpers to Fit Many Popular Relays on Honda, Nissan, Toyota, Newer Ford and GM Mini Micro Relays as Well as International Trucks
- Set Comes in Blow Mold Case for Storage



Relay Puller Pliers

SKU 291342
LIS46950 **19⁹⁹**

- For Removing Electrical Relays on Most Domestic and Import Vehicles
- Allows Relay to Pop Free from Socket with Less Chance of Damaging the Relay



Circuit Tester

Digital Display Circuit Tester

SKU 568468
24451 **39⁹⁹**

- Detect Voltage, Power, Ground and Circuit Condition
- Display Provides Precise Voltage
- Voltage: 5-30V DC
- Computer Safe - Do Not Use on Airbags

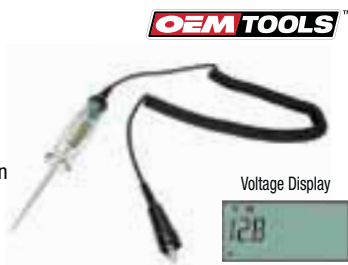

OEM TOOLS™

Computer Safe Circuit Tester

SKU 222515
LIS24550 **14⁹⁹**

- Indicates Polarity
- Draws Less Than 21 mA at 12 Volts DC
- Operating Range: 3 - 28 Volts



AmpHound Tester

SKU 222515
27355 **14⁹⁹**

- Use on 6, 12 and 24 V Electrical Systems
- No Need to Remove a Fuse Which Reduces the Amount of Time to Determine the Current in the Circuit

- Finding Parasitic Drains Can Now Be Done Without Resetting the Offending Circuit
- Tests All of the Most Common Automotive Fuses Types and Amp Ranges



OEM TOOLS™

Terminal Tools

19 Piece Master Terminal Tool Kit

SKU 447159
27169 **99⁹⁹**

- Latest Tools for Coolant Sensors, Wiring Harnesses and Terminal Blocks on Most Modern Vehicles
- Eliminates Potential Damage to Wires or Terminal Blocks
- Application Chart Included Inside Storage Case



OEM TOOLS™

Terminal Tool

SKU 191676
25228 (Green) **19⁹⁹**

- Specialized Prongs Designed to Depress "Barbs" on Conventional Terminals
- Eliminate Damaged Wires and Terminals



Terminal Tool for GM and Domestic Motors

SKU 255953
25229 (Red) **19⁹⁹**

- Used to Remove Wires from Terminals without Damaging the Wire or the Terminal
- Fits Most GM and Domestic Motors Computer Connectors and Terminals

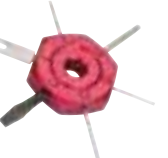

Wire Strippers

6-IN-1 LONG NOSE PLIERS

SKU 177785
22631 **24⁹⁹**

- All-in-One Design
- Offset Jaw for Improved Visibility
- Ergonomic Pistol Grip for Added Leverage
- Ideal for Hard-to-Reach Spots

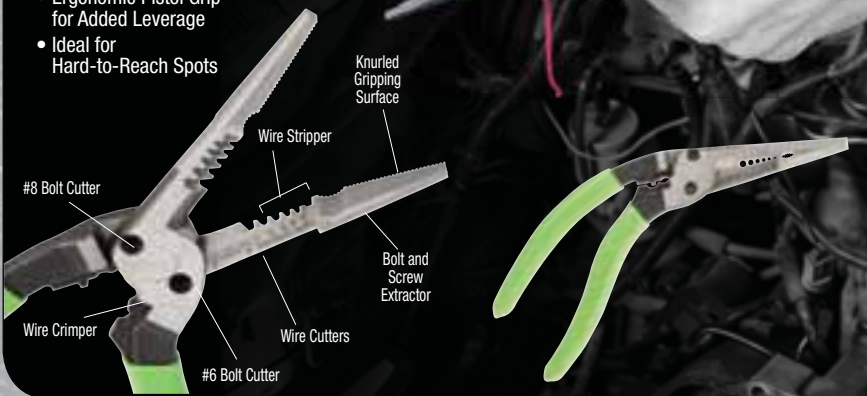

OEM TOOLS™

Innovative Tools. Better Value. Quality Results.

Compact 8-14 Gauge Wire Stripper

SKU 751657
24452 **19⁹⁹**

- Strips 20-12 Gauge Insulated and Non-Insulated Wire
- Length: 7"
- Use for Wire Cutting and Stripping, as Pliers for Grabbing and Twisting or for Crimping of Insulated and Non-Insulated Connectors



OEM TOOLS™

Wire Cutter/Stripper Combo

SKU 191685
25192 (Small) **17⁹⁹**

- Used for Soft Copper, Electrical Wires
- Self-Adjusts to Wire Sizes: 14 AWG to 26 AWG
- Grab, Hold and Strip Wire in One Quick Motion
- Jaws are Made of Surgical Steel



OEM TOOLS™

CrimPro™ 4-in-1 Angled Wire Tool

SKU 087314
OTC5950A **27⁹⁹**

- Compact 7" Design
- Gripping Nose
- Crimper, 12-20 AWG Insulated and Non-Insulated Wire
- Stripper - Strips 12-20 AWG Wire
- Cutter - Ability to Make Cuts Both Above and Below Pivot



CrimPro™ 4-in-1 Wire Tool

SKU 087317
OTC5950S **25⁹⁹**



Remote Starters

Heavy Duty Remote Starter Switch

SKU 265127
25331 **29⁹⁹**

- Heavy Duty, Push Button Remote Starter Allows Technicians to Bump or Crank Engines While Under the Hood
- 5' Heavy Insulated Wire for Long Tool Life
- Heavy Duty Insulated Alligator Clips



Remote Starter Switch

SKU 265124
25330 **19⁹⁹**

- Heavy Clips with Insulated Sleeves Attach to Ground and Starter Solenoid Switch
- 6' Heavy Insulated Wire for Long Tool Life



OEM TOOLS™

Ignition Tester

In-Line Ignition Spark Tester

SKU 900800
25227 **8⁹⁹**

- Quickly Troubleshoot Ignition System
- "Hands-Free" Device Connects In-Line Between Spark Plug and Plug Wire
- Shows a Duplicate View of the Ignition Spark
- Technician Can Visually Check Condition of Ignition System at Each Cylinder



OEM TOOLS™

STORE STOCKED

Fuse Buddy™

3-in-1 Tester Fuse Buddy Pro Tester Kit

SKU 374602
ESI310 **94⁹⁹**

- 3 Interchangeable Test Functions:
- 30 Amp MINI Circuit Amperage Testing
 - 30 Amp ATC Circuit Amperage Testing
 - 30 Amp All Purpose Amperage Testing



Fuse Buddy Current Loop Mini

SKU 374610 | ESI307M **34⁹⁹**

Fuse Buddy Tester Mini 30 Amp

SKU 374613 | ESI305M **39⁹⁹**

Fuse Buddy Tester ATC 30 Amp

SKU 374603 | ESI306B **39⁹⁹**

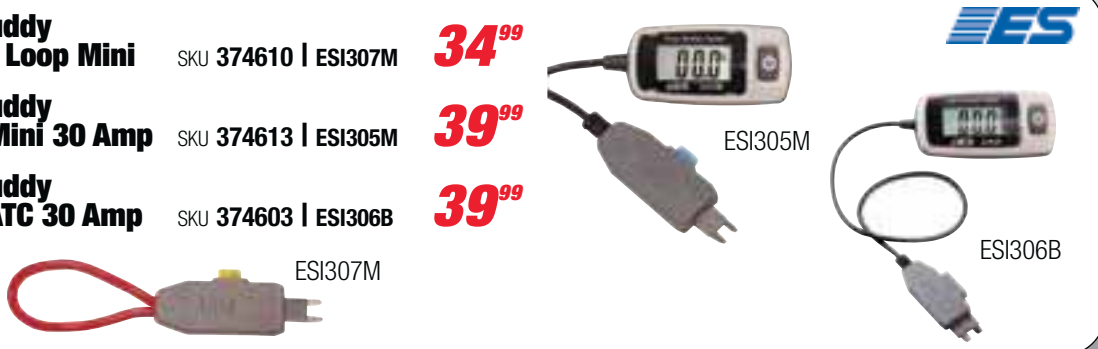

Lockout Tools

BigEasy™ Glo with Easy Wedge Lockout Kit

SKU 964494
STK32955 **84⁹⁹**

- Glow-in-the-Dark Yellow Allows You to See the Tool at Night or Through Tinted Windows
- Easy Wedge Offers Controlled Opening of the Car Door for Inserting the BigEasy Glo

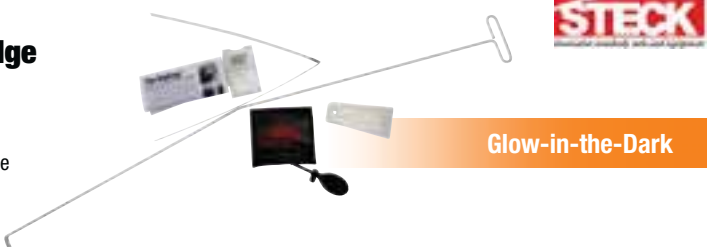

BigEasy™ Lockout Tools Kit

SKU 964491
STK32900 **44⁹⁹**

- High Visibility Pink Powder Coating and Improved Non-Marring Wedge
- Lock Knob Lifter for Cars with Flat Lock Knobs at the Top of the Door
- Paint Protector Reduces Friction Between the Car Door and the BigEasy

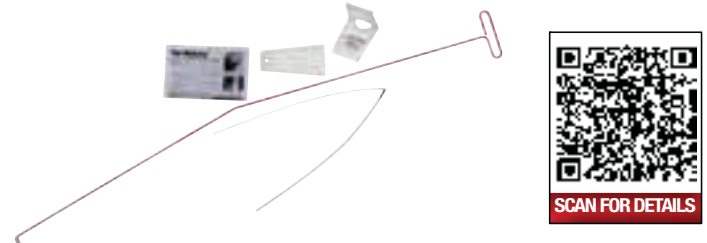

BigEasy™ Carrying Case

SKU 227873
STK32935 **34⁹⁹**

- Made of Soft, Yet Firm Material to Protect Your BigEasy Kit
- Custom Pockets for the BigEasy, Non-Marring Wedge, Lock Knob Lifter and Easy Wedge
- Makes it Convenient to Stow Your BigEasy Kit in Your Truck



BigEasy™ Easy Wedge (Inflatable)

SKU 964493
STK32922 **44⁹⁹**

- Inflatable Controlled Opening of Car Door for Insertion of the BigEasy



BigEasy™ Loop

SKU 964492
STK32903 **17⁹⁹**

- Clips to Any BigEasy to Allow Grabbing of Door Handles and Locks, it Even Glows in the Dark
- Provide Easy Leverage to Pull Door Handles and Window Cranks During the Door Unlocking Process
- Handy Accessory Tool Easily Snaps on the End of the BigEasy Tool Avoiding Need to Purchase Additional, More Costly Specialty Tools



Lock and Snap Ring Pliers

OEM TOOLS™

10 Piece Snap Ring Pliers Set

SKU 900819
27180 **59⁹⁹**

- For Both Internal and External Rings
- Set Includes: 5-1/2" Bent Pliers with .038" Tip; 6" Straight Pliers with .038" Tip; 5-1/2" Bent Pliers with .047" Tip; 6" Straight Pliers with .047" Tip; 7-1/2" Bent Pliers with .070" Tip; 8" Straight Pliers with .070" Tip; 8-1/2" Bent Pliers with .090" Tip; 9" Straight Pliers with .090" Tip
- Also Includes Two Stainless Steel Handle Picks



BONUS VALUE: \$9.99

6-1/2 Inch Heavy Duty Snap Ring Pliers Set - 2 Piece

SKU 141502 | 25356

- Internal and External Snap Ring Pliers with Patented Tapered Tips to Securely Grip Snap Rings



With Purchase of:
10 Piece Snap Ring Pliers Set
SKU 900819 | 27180

OR
Angle Tip Lock Ring Pliers
SKU 191055 | 25354

Offer Good Through March 31, 2019 While Supplies Last

Angle Tip Lock Ring Pliers

SKU 191055
25354 **11⁹⁹**

- Jaws are Scored on the Outside for Secure Gripping
- Spring Loaded Jaws
- Spread: 3/4"
- Length: 8-1/4"



Rivet Tools

Big Daddy® Hand Riveter

SKU 094886
MAR39031 **104⁹⁹**

The Big Daddy is the Most Versatile and Powerful Hand Riveter. Sets Large Diameter Blind Rivets.

- Double Gear Reduction System Easily Sets from 1/8" to 1/4" Diameter Klik-Fast Rivets in All Alloys Including 1/4" Klik-Split® Rivets
- Comes with 5/32", 3/16" and 1/4" Nose Pieces Stored in the Body



Industrial Riveter

SKU 291353
25921 **49⁹⁹**

- For Use with Steel and Aluminum Rivets Noses: 1/8" (3.2 mm), 5/32" (4.0 mm), 3/16" (4.8 mm), 1/4" (6.4 mm)
- 18" Overall Size with Long Handle Provides More Leverage



Deluxe Riveter Kit

SKU 094877
MAR39001KIT **39⁹⁹**

The Choice of Professionals

- Kit Includes: HP-2 Riveter. Sets Up to 3/16" Diameter Rivets, (200) Rivets and Molded Case
- MAR39003KIT Same as MAR39001KIT but Contains (200) Assorted Klik-Fast Stainless Steel Rivets



SKU 094879
MAR39003KIT **39⁹⁹**
Stainless Steel

Air Over Hydraulic Powered Rivet Tool

SKU 222750
MARAK-175 **419⁹⁹**

- Sets 1/8" - 1/4" Steel Rivets with Up to 3,500 Lbs. of Pull Capacity
- Unique Jaw System Accommodates 1/8" - 1/4" Rivet Sizes By Simply Changing the Nose Assembly (No Tools Required)



KLIK-LOK Plastic Rivet Setter

SKU 222531
MAR48005 **44⁹⁹**

- Includes a Universal Nose Piece That Sets All Plastic Rivets



Windshield Tools

Universal Wiper Arm Puller

SKU 265136
25339 **29⁹⁹**

- Prevents Damage to Wiper Arm
- Cross-Piece Special for Wiper Featuring a Nozzle



Windshield Wiper Arm Puller

SKU 191681
25319 **15⁹⁹**

- Easily Removes Wiper Arms on Most Domestic and Foreign Vehicles



18" Professional Windshield Knife

SKU 480782
CAL53100 **24⁹⁹**

- Length: 18"
- Constructed of Heavy Duty Steel and Aluminum with a Padded Ergonomic Handle



Double Head Suction Cups

SKU 291351
24246 **16⁹⁹**

- Twin Head Suction Cups Help Remove Windshields
- ABS Rubber Cups Grab Hold to Glass
- Flexible Handle Bends to Windshield



Window Molding Clip Remover

SKU 265130
25338 **14⁹⁹**

- Use to Release Body Molding Clips
- The Double-Sided Design Works on a Variety of Clip Configurations
- Made with Heat-Treated Carbon Steel for Strength



Ball Joint Separator

Hydraulic Ball Joint Separator

SKU 177718
25219 **99⁹⁹**

- Hydraulic Ram Rated to 8 Tons
- Jaw Capacity: 56mm (2.25")
- Jaw Width: 22mm (0.86")



Balancer Remover

GM Harmonic Balancer Puller

SKU OUTSIDE BUY/EPO
25264 **119⁹⁹**

- Designed to Remove Harmonic Balancers without Tapped Holes
- Time Saving Tool - No Need to Remove Radiator
- GM Applications: 5.3 L, 5.7 LS1, 6.0 LS2, 6.2 LS3, 7.0 L
- Chrysler/Jeep/Dodge: 3.5 L V6, 3.6 L V6, 4.7 L V8, 5.7 L V8, 6.1 L V8



Available via Outside Buy/EPO, Call 1-877-298-6651 for Ordering Instructions

TIME SAVING. MONEY MAKING TOOLS.

G & G Technics
Innovative Automotive Tools

HARMONIC BALANCER REMOVER

SKU 596957
GGT-180 **149⁹⁹**

- Quick Couple Connectors
- One Piece High Tension Steel
- Hardened and Tempered to 40HRC
- Will Not Damage Balancer or Belt Ribs

COMPATIBILITY - Various 3 and 6 Spoke Balancers

GM	5.3 Litre	Ford	Coyote 5.0
GM	5.7 LS1	Chrysler	3.5 Litre
GM	6.0 LS2	Dodge	3.5 Litre V6
GM	6.2 LS3	Jeep	4.7 Litre
GM	7.0 Litre		5.7 Litre
			6.1 Litre V8



THREAD REPAIR

Ford Triton Repair Kit

Ford Cylinder Head Repair Set

SKU 104283
24200 **259⁹⁹**

Current Repair Takes About 10 Labor Hours, This Tool Cuts Time to 30-60 Minutes

- Comes with Instructional Video
- Repair Ford Triton Modular Engines (1996 - 2003) with Spark Plug Thread Erosion
- Works on Ford 4.6, 5.4, 6.8 V10 Engines
- Individual Inserts Available as Part Number 24203; the Patented Replacement Insert is a Permanent Fix That Does Not Have to Be Replaced with Every Tune-Up
- Patented Guide Makes Drilling and Tapping in a Straight Line Easy
- Set Includes: Instruction Sheet, DVD, (6) Inserts, Reamer Tap, Drill Bit, Expanding Tool and Air Blower Accessory Assembly



Ford Triton M14 x 1.25 Repair Insert

SKU 104287
24203 **22⁹⁹**

- Alloy Steel Insert - Not Aluminum
- Seals Perfectly and Prevents Any Loss of Compression
- Taper on the Inside of the Insert That Seats the Spark Plug

Ford Triton 3 Valve Set

SKU 343388
CAL39300 **259⁹⁹**

- Application: 2004-2008 Ford 4.6 and 5.4 3 Valve Engines That Have Spark Plugs That are M16 x 1.5
- Includes (8) Inserts



M16 x 1.5 3 Valve Insert

SKU 396658
CAL393-100 **17⁹⁹**

- Note: THIS IS NOT the Replacement Insert for the Triton 2 Valve Kit

Ford Spark Plug Remover Kit, Triton 3V

SKU 087307
OTC6918 **139⁹⁹**

- Unique Design Helps Prevent Breakage By Locking the Plug Porcelain Core to the Plug Hex Allowing it to Turn as One Complete Unit
- Will Also Pull Plug Porcelain Core if Only Plug Hex is Removed
- Detailed Instructions Included



Ford Spark Plug Extractor Set

SKU 104286
24201 **69⁹⁹**

- Works to Extract Frozen and Broken Off Spark Plug Sleeves in 2004 to Present Ford Triton Engines
- Specially Machined Guide Works with Extra Long Tap and Extractor to Make Sure the Job is Done Right



Ford Spark Plug Porcelain Extractor Set

SKU 104290
24202 **24⁹⁹**

- Use to Extract the Broken Porcelain from Broken Spark Plugs in 2003 to Current Ford Triton Engines
- In Some Cases the Porcelain Will Break Off in the Sleeve and Will Need to Be Extracted in Order for the 24201 to Function Effectively
- Unlike Other Tools That Tell You to Push the Porcelain Through the Sleeve (Ford Says Specifically Not to Do This), This Tool Adheres to the Porcelain Using a Special Adhesive and Then Allows a User to Extract the Broken Porcelain from the Sleeve



Ford Triton Plug-Saver® Kit

SKU 094873
FIX98140T **119⁹⁹**

- Designed to Specifically Repair the Spark Plug Ports in 4.6, 5.4 and 6.8 Ford Triton Engines

- Repairs Worn, Damaged Threads
- Includes Self Cutting Tap, Tool and Eight Inserts in a Sturdy Case



Inserts (Pack of 8)

SKU 110263
FIX98149P **27⁹⁹**

Broken Porcelain Extractor and Electrode Shield Removal Kit

SKU 409621
27274 **10⁰⁰**



Replacement Pins (10 Pack)

SKU 248476
24205 **4⁹⁹**

OEM TOOLS

Spark Plug Thread Repair

M12 - 1.25 Spark Plug Thread Repair Kit

SKU 789141
25640 **37⁹⁹**

- Kit Includes: 6 Thread Inserts, Thread Installer Tool and Thread Tap
- Designed for Rethreading in All Materials Such as Alloys, Steels, Plastics, Magnesium, etc.
- Specified for Military, Aviation, and Other Critical Usage
- Inserts are Made from High Quality 18/8 Stainless Steel Wire with a Diamond Shaped Cross Section Wound to the Shape of a Spring Thread

OEM TOOLS

14 mm Tapered Spark Plug Thread Repair Kit

SKU 141511
25647 **29⁹⁹**

- Can Be Used to Repair Both Taper Seat and Gasket Type Spark Plug Assemblies
- Three Insert Lengths are Available to Accommodate Most Spark Plug Reaches
- Positive Mechanical Locking Feature Means the Insert Will Never Come Out
- Piloted Reamer Tap Means No Drilling is Necessary and Perfect Alignment of the Tapped Hole

OEM TOOLS

M14 - 1.25 Spark Plug Thread Repair System

SKU 557108
25643 **29⁹⁹**

- Replaces Threads for 14 mm Spark Plug
- Kit Includes: 3 Thread Inserts, Thread Installer Tool and Thread Tap
- Size: M14 - 1.25
- Not for Tapered Spark Plugs

14 mm Spark Plug Rethreader Kit

SKU 265137
25649 **7⁹⁹**

- Set Includes Combination Tap/Reamer and 3/8", 7/16", 1/2" and 3/4" Inserts

OEM TOOLS

Limited Access Spark Plug Chaser

SKU 607068
25155 **12⁹⁹**

- Fits Spark Plug Holes with Limited Access. Narrow Profile and Long Length Allows Access to Spark Plug Holes in Confined Spaces.
- Use with a 3/8" Ratchet or Extension
- Size: M14 x 1.25



Spark Plug Thread Repair Inserts M12 - 1.25 (10 Pack)

SKU 082946
OEM25641 **9⁹⁹**

14 mm Tapered Spark Plug Inserts

SKU 141512
25648 **11⁹⁹**

STORE STOCKED

M14 mm - 1.25 Thread Inserts

SKU 557140
25644 **9⁹⁹**

- 10 Pieces in Sizes M14 - 1.25 x 3/8", 1/2", 3/4"

STORE STOCKED

Spark Plug Hole Thread Chaser

SKU 070109
25124 **6⁹⁹**

- Cleans Spark Plug Threads of Dirt and Carbon Build-Up
- Double-Ended 14mm and 18mm Design
- For Use with 13/16" Deep Sockets



Spark Plug Hole Thread Chaser

SKU 081200
LIS20200 **10⁹⁹**



Drain Plug Repair

Drain Plug Repair Kit

SKU 818569
CAL38400 **72⁹⁹**

- Designed to Repair Aluminum Oil Pans with Damaged Drain Plug Threads, Size M12 x 1.75 Commonly Found in GM, Ford and Mazda Vehicles
- Drain Plug Repair Kit Contains a Drill, Counter Bore, Tap, Driver, Guide and (5) 12 mm Inserts
- Allows Users to Use Original Plug Instead of a Replacement



5 Pack Drain Plug Inserts

SKU 850539
CAL384-5 **17⁹⁹**

External Thread Repair

Universal Outside Thread Chaser - 1"- 5"

SKU 466494
25137 **109⁹⁹**

- 6 Dies Restore Damaged Threads to Their Original Condition



2 Piece External Thread Repair Set - 5/32"- 1-1/2"

SKU 343361
NES1000 **199⁹⁹**

- Includes the NES1A and NES2 Restores Inch or Metric, Right or Left Handed Fastener Threads



SEE FULL LINE OF NES ON AZTOOL1.COM

Oxygen Sensor Thread Repair

Oxygen Sensor Thread Chaser

SKU 607067
25255 **13⁹⁹**

STORE STOCKED

Oxygen Sensor Thread Repair Kit

SKU 010134
FIX38189-1 **89⁹⁹**

- No Need to Replace Exhaust Manifold
- Pilot Nose Tap Provided



Axle Spindle Thread Repair

Axle Spindle Threading Set

SKU 514007
27233 **59⁹⁹**

- Used to Clean or Repair Axle Threads
- Included: M20 x 1.25, M20 x 1.50, M22 x 1.00, M22 x 1.50, M24 x 1.50, M24 x 2.00, 13/16" x 20 UNEF, 3/4" x 20 UNEF and 27mm Extension Bar



Head Bolt Thread Repair

Metric Head Bolt Thread Repair Kit

SKU 010131
FIX35119S **149⁹⁹**

- Applications - Cadillac, Honda, Toyota and Other Imports
- Extended Reach for Deep Threads
- Longer Length (33mm) Inserts for Maximum Thread Engagement



Thread Repair

Metric Thread Repair Kits				Replacement Inserts			SAE Thread Repair Kits				Replacement Inserts		
SKU	Part No.	Size	Price	SKU	Part No.	Price	SKU	Part No.	Size	Price	SKU	Part No.	Price
516472	25626	M6-1	29.99	516473	25627	6.99	557009	25602	UNC 1/4" - 20	22.99	557116	25603	6.99
516474	25628	M8-1.25	29.99	516475	25629	7.99	557017	25604	UNC 5/16" - 18	22.99	557124	25605	6.99
516477	25632	M10-1.5	29.99	516478	25633	7.99	557090	25606	UNC 3/8" - 18	22.99	557132	25607	7.99
466588	25634	M12-1.75	35.99	516470	25613	3.99	516464	25608	UNC 7/16" - 14	29.99	516465	25609	7.99
							516467	25610	UNC 1/2" - 13	29.99	516468	25611	9.99
							466578	25614	UNC 1/4" - 28	29.99	978101	25623	9.99
							466582	25620	UNC 7/16" - 20	22.99	516463	25601	7.99

OEM TOOLS

Bolt Extraction

Spiral Bolt Extractor Sets

- Bites into Rusted, Rounded and Painted Over Nuts and Bolts**
- Grips and Removes a Wide Range of Stubborn Fasteners
 - Includes SAE and Metric Sizes: 5/16", 11/16", 3/4", 3/8", 1/2", 9/16", 5/8", 8 mm, 10 mm, 13 mm, 14 mm, 16 mm and 19 mm
 - Aluminum Rails Offers Easy-Access Storage

10 Piece Spiral Type Bolt Extractor Set

SKU 081788 **49⁹⁹**
22988



TOOL of the MONTH
MARCH
SEE INSERT FOR DETAILS

OEM TOOLS™

USE WITH A VARIETY OF TOOLS:



Locking Pliers



Wrench



Ratchet



Specialized Spiral Design for a Secure Universal Grip on Nuts and Bolts

5 Piece Extractor Set on Rail

SKU 081304 **29⁹⁹**
22985

- Fits: 5/16" & 8mm, 10mm, 13mm, 11/16", 3/4", & 19mm Fasteners

5 Piece Extractor Add-On Set

SKU 081306 **19⁹⁹**
22987

- Adds 3/8", 7/16", 1/2", 9/16", & 5/8" Sizes

5 Piece Deep Extractor Set on Rail

SKU 081305 **29⁹⁹**
22986

- Fits: 3/8", 9.5mm, 7/16", 11m, 1/2", 12.5mm, 9/16", 14mm, 5/8", & 16mm Fasteners

Nut Busting Bolt Extractor Socket Sets

- High Visibility Markings for Fast, Easy Socket Selection
- 3/8" Drive
- Specialized Design for a Secure Universal Grip
- Chrome-Molybdenum Steel Construction for Maximum Durability



18 Piece SAE and Metric

SKU 764976 **49⁹⁹**
22980

- Includes SAE Sizes: 1/4", 5/16", 3/8", 7/16", 1/2", 9/16", 5/8", 11/16", 3/4"; Metric Sizes: 8, 10, 11, 12, 13, 14, 16, 17 and 19 mm

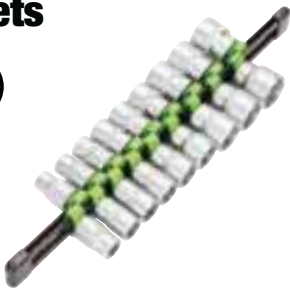

9 Piece Metric

SKU 751718 **24⁹⁹**
22967

- Includes Metric Sizes: 8, 10, 11, 12, 13, 14, 16, 17 and 19 mm



9 Piece SAE

SKU 751720 **24⁹⁹**
22968

- Includes SAE Sizes: 1/4", 5/16", 3/8", 7/16", 1/2", 9/16", 5/8", 11/16" and 3/4"



Color of Rail May Vary

7 Piece Bolt Extractor Nut Driver Set

SKU 298210 **19⁹⁹**
22990

- SAE Sizes: 3/16", 1/4", 3/8", 7/16", 1/2"
- Metric Sizes: 8 mm, 10 mm
- Use with Impact Driver, Drill and Driver Handle



10 Piece Bolt Extractor Set

SKU 231204 **19⁹⁹**
25467

- 5 Mechanic's Length R.H. Cobalt Drill Bits
- Set Includes Extractors Size: #1, #2, #3, #4, #5 and Bits: 5/64", 7/64", 5/32", 1/4" and 19/64"



STORE STOCKED

Screw Extraction Bits

10 Piece Spiral Extractor and Drill Bit Combo Pack

SKU 099229 **14⁹⁹**
24373

- Extractors: Ex-1, Ex-2, Ex-3, Ex-4 and Ex-5
- Left Hand 135 Degree Split Point Cobalt
- Drill Bit Sizes: 5/64", 7/64", 5/32", 1/4" and 19/64"
- Pilot Point Starts on Contact and Eliminates Bit Walking



6 Piece Extractors Only

SKU 099277 **8⁹⁹**
24374

- Extractors: Ex-1, Ex-2, Ex-3, Ex-4, Ex-5 and Ex-6

10 Piece Multi-Spline Screw Extractor Set

SKU 099281 **17⁹⁹**
24375

- Contains Sizes from 1/8" - 13/32" in 1/32" Increments
- Can Be Used with Hand Sockets and Wrenches
- Aggressive Left Hand Spiral Design Provides Extra Gripping Power



35 Piece Master Screw Extractor/Drill Bit Set

SKU 099258 **89⁹⁹**
24377

- Spiral and Multi-Spline Extractors for Removing the Toughest Bolts and Screws from 3/32" to 15/16"
- OEM 135° Split Point Left Hand Cobalt Drill Bits



25 Piece Screw Extractor/Drill and Guide Set

SKU 099215 **19⁹⁹**
24376

- Can Be Used on Thread Sizes 5 mm to 16 mm
- Turns Broken Fastener Out and Permits Highest Torque without Expansion

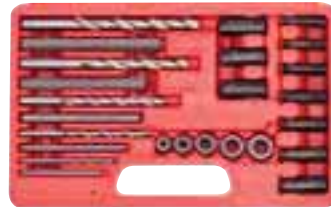

Damaged Screw Extractor Set - 4 Piece

SKU 081310 **7⁹⁹**
25158

- Used to Quickly Remove Stripped, Broken and Painted-Over Screws
- Will Work with Phillips, Flathead, Hex and Other Common Screws



Stud Remover/Installer

Stud Extractor

- Remove Stripped, Rusted, Smooth or Broken Studs
- Universal Design; Clamps 1/4" to 1/2" (6 mm to 12 mm) Studs
- Can Be Used with Hand Ratchets and Air Ratchets

1/2" Drive SKU 012652 | 25218 **18⁹⁹**

3/8" Drive SKU 012658 | 25217 **18⁹⁹**



4 Piece Stud Remover Set - SAE

SKU 695112 **25⁹⁹**
33627136

- SAE: Used to Remove and Install 1/4", 5/16", 3/8" and 7/16" Studs



4 Piece Stud Remover Set - Metric

SKU 695108 **25⁹⁹**
33627140

- Metric: Used to Remove and Install 6, 8, 10 and 12 mm Studs

Trim Clips

Profit and productivity always take a hit when inexpensive service parts are not readily available. Trying to locate, source or wait for delivery of a low-cost item results in idle service bays, wasted technician time and lost profit. The JohnDow Dynamic Automotive Service Parts Assortments Program solves these problems.

Available via Outside Buy/EPO, Call 1-877-298-6651 for Ordering Instructions



DOWDY-BLF-5

JohnDow Dynamic™

VISIT AZTOOL1.COM FOR MORE INFORMATION ON CONTENTS

PART #	SKU	DESCRIPTION	ASSORTMENT	TOTAL PIECE COUNT	OTHER INFORMATION	PRICE
DOWDY-DPA-6	OUTSIDE BUY/EPO	Drain Plug And Gasket Assortment Kit	18 Drain Plug Variations, 4 Gasket Variations	88		86⁹⁹
DOWDY-DGK-240	OUTSIDE BUY/EPO	Master Drain Plug Gasket Assortment Kit	24 Drain Plug Gasket Variations	240	Aluminum, Copper, Crush, Fold-Over, Nylon, Rubber/Metal	89⁹⁹
DOWDY-WS-1	082949	Wheel Stud Assortment	12 Wheel Stud Variations	60		93⁹⁹
DOWDY-WN-12	092947	Wheel Lug Nut Assortment A	12 Lug Nut Variations	120	Standard, Dome, Acorn Thread	58⁹⁹
DOWDY-WN-12B	082948	Wheel Lug Nut Assortment B	12 Lug Nut Variations	120	Dome Acorn, Bulge, Flat-Capped, External Thread	95⁹⁹
DOWDY-BA-6	082942	Master Cylinder Brake Line Adapter Kit	16 Cylinder Line Adapter Types	80	Metric To Metric, SAE To Metric, SAE To SAE	126⁹⁹
DOWDY-BLF-5	082943	Master Brake Line Fitting Assortment Kit	23 Brake Line Fitting Variations	115	Tube Nuts, Union, Brake Line Adapters	79⁹⁹
DOWDY-6000U	082940	Domestic Retainer Assortment Kit	23 Retainer Variations	230	For Doors, Trim And Shrouds	42⁹⁹

SHOP EQUIPMENT

Parts Washers

OEMTOOLS™ Parts Washers are a New Generation of Water-Based Parts Washers Providing All the Cleaning Power of Solvent While Using Cleaning Solutions That are Safe and Biodegradable.

20 Gallon Mobile Parts Washer **OEMTOOLS™**
 SKU 750449 **229⁹⁹**
 24805

- Features Casters for Maneuverability
- Durable Powder-Coated Steel Construction
- Working Capacity: 12 Gallons (45L)
- Dimensions: 38" x 21.5" x 37"



20 Gallon Parts Washer **OEMTOOLS™**
 SKU 300117 **179⁹⁹**
 24801

- Water-Based Parts Washer with 325 Gallon per Hour Electric Pump
- Steel Work Basin is 31"(L) x 21"(W) x 34.5"(H)
- Lid Includes Fusible Link for Fire Safety

Replacement Washer Pump
 SKU 462484 **39⁹⁹**
 24800-12

- Fits OEMTOOLS™ 24800 and OEMTOOLS™ 24801 Water-Based Parts Washer



Color May Vary

40 Gallon Parts Washer **OEMTOOLS™**
 SKU 300118 **328⁹⁹**
 24803

- Use with Non-Flammable, Water-Based Degreaser or Cleaning Agent
- Fully Flexible Nozzle and Fusible Link Which Automatically Closes the Lid in Case of Fire
- Dimensions: 44.75"(L) x 20.5"(W) x 35"(H)

Replacement Washer Pump
 SKU 462476 **39⁹⁹**
 24803-31

- Fits OEMTOOLS™ 24803 Water-Based Parts Washer



Color May Vary

Bench Top Gallon Parts Washer **OEMTOOLS™**
 SKU 300128 **79⁹⁹**
 24800

- Water-Based Parts Washer with 325 Gallon per Hour Electric Pump
- Steel Work Basin is 18"(L) x 13.5"(W) x 9"(H)

Replacement Washer Pump
 SKU 462484 **39⁹⁹**
 24800-12

- Fits OEMTOOLS™ 24800 and OEMTOOLS™ 24801 Water-Based Parts Washer



Color May Vary

Portable Bucket-Top Parts Washer **OEMTOOLS™**
 SKU 003759 **39⁹⁹**
 24816

- Fits Most Standard 5 Gallon Buckets
- Includes a Submersible Pump, 40" Hose and Flow-Through Brush
- Pumping Rate: 1 GPM
- For Degreasing Small Parts and Tools



Does Not Include 5 Gallon Bucket

Mobile Parts Washer **OEMTOOLS™**
 SKU 546660 **129⁹⁹**
 24804

- Solution Capacity (Gallons): Min. 2 - Max. 4
- Use with Water Works™ Heavy Duty Degreaser Concentrate
- Not for Petroleum Based Solvents
- Weight: 11 Lbs.
- Dimensions: 26"(L) x 18" (W) x 9.5"(H)

Lid has Positive Seal and Latches for Mobility



16 Gallon Solvent Parts Washer **CLEANMASTER**
 SKU 479979 **489⁹⁹**
 FOU62125-01

- Removable Screen Filter for Pump Protection
- Flow Through Brush with Adjustable Fluid Control
- Galvanized Drawn Sink Means No Leaks
- Inside Sink Dimensions: 31"(L) x 21"(W) x 9"(D)

30 Gallon CleanMaster Solvent Parts Washer
 SKU 479981 **824⁹⁹**
 FOU54821-01

Includes Drum



RS500D Professional Spray Wash Cabinet **Ranger PRODUCTS**
 SKU 082919 **3,979⁹⁹**
 RANRS500D

- Inside Height: 43"
- Heavy Duty Steel Construction
- Removable Parts Tree
- Brass Nozzles
- Heavy Duty Rubber Casters
- Stainless Oil Skimmer
- Removable Tank Screen



Inside Height 43"

Liftgate Service
 SKU 262533 **95⁰⁰**
 RANLIFTGATE

BONUS VALUE: 64.99

20 Lbs. Aluma-Klean Soap Bucket
 SKU 751966
 RAN5155096

With Purchase of:
RS500D Professional Spray Wash Cabinet
 SKU 082919
 RANRS500D

OR
RS750D Truck Spray Wash Cabinet
 SKU 082920
 RANRS750D

Offer Good Through March 31, 2019 While Supplies Last



RS750D Truck Spray Wash Cabinet **Ranger PRODUCTS**
 SKU 082920 **4,889⁹⁹**
 RANRS750D

- Inside Height: 54"
- Heavy Duty Steel Construction
- Removable Parts Tree
- Brass Nozzles
- Heavy Duty Rubber Casters
- Stainless Oil Skimmer
- Removable Tank Screen



Inside Height 54"

Liftgate Service
 SKU 262533 **95⁰⁰**
 RANLIFTGATE

12 Gallon CleanMaster Low Profile Solvent Brake Parts Washer **CLEANMASTER**
 SKU 479982 **809⁹⁹**
 FOU57429-01

- Flow-Through Brush System for Efficient Cleaning
- Durable, Baked-On Powder Coated Epoxy Finish
- Easy-Roll Swivel Casters (2 Locking)



Air Operated Sprayer **LINCOLN**
 SKU 222507 **49⁹⁹**
 LIN5983

- 1/4" NPT (F) Inlet
- Max. Operating Pressure: 150 PSI
- Can Be Used with Solvents or Detergent Solutions



Atlasta® Parts Cleaning Brush
 SKU 342339 **19⁹⁹**
 PBC50003

- A Tough Brush That Will Last and Last
- Length: 9.75" (25 cm)



Oriflo® Flow-Through Parts Brush
 SKU 342336 **24⁹⁹**
 PBC50001

- Long Lasting, Stiff Trialoy® Polyester Filament Can Be Used with Either Petroleum or Water-Based Cleaning Solutions
- Length: 10.25" (26 cm)



Flow-Through Brush with Hose **Parts Brush Division**
 SKU 459114 **26⁹⁹**
 PBC50001H

- Oriflo Flow-Through Parts Washer Brush and High Quality Hose to Connect to Your Parts Washer



Heavy Duty Degreaser Concentrate - 5 Gallons (1) 5 Gallon Container **WATER WORKS**
 SKU 227558 **139⁹⁹**
 WWSHD-5G

Designed to Effectively Replace Hazardous Solvent in Water-Based Parts Washers

- Concentrated to Be Powerful and to Save You Money
- Quickly Removes Grease, Oil, Carbon and Grime While Safe for the Technician



EcoMaster Heated Aqueous Portable Brake Washer **FOUNTAIN INDUSTRIES, LLC**
 SKU 479988 **1,079⁹⁹**
 FOU61840-02

- Heavy Duty Air Pump
- Heavy Duty Drum Dolly with Two Locking Casters and Two Regular Casters
- Prefilter Screen and Asbestos Sock Filter Designed to Ensure Clean Solution
- Heater: 1,000W - Thermostatically Controlled to Hold at 115° F
- Sink Dimensions: 24"(L) x 20"(W) x 7"(D)



EcoMaster Heated Aqueous Parts Washer **FOUNTAIN INDUSTRIES, LLC**
 SKU 479983 **1,569⁹⁹**
 FOU61330-02

- Capacity: 45 Gallons
- Heater Thermostatically Controlled Preset to 110° F
- Filter System Prolongs Fluid Life

Molded Cart for EcoMaster Heated Aqueous Parts Washer
 SKU 479985 **269⁹⁹**
 FOU61332

- 500 Lbs. Capacity
- High Density Polyethylene Molded Tray



Storm Ultra Spray Wash Solution - 5 Gallons (1) 5 Gallon Container **WATER WORKS**
 SKU 227559 **159⁹⁹**
 WWSU-5G

- Professional Wash Solution for Heated Spray Cabinet/Jet Cabinet Style Parts Washing Equipment
- Super Concentrated for Cost Effectiveness
- Quickly Blasts Away Grease, Oil, Carbon and Grime



Abrasive Blasting

Abrasive Blast Cabinet (Bench Top) **OEMTOOLS™**
 SKU 300119 **189⁹⁹**
 24815

- Easily Remove Paint, Rust and Oxidation
- Fits on Bench or Cabinet
- Dimensions: 19.3"(H) x 19.3"(W)
- Cubic Inches: 28.6"



Color May Vary

Glass Bead Coarse Media, 25 Lbs.
 SKU 010136 **49⁹⁹**
 SHA13077

- Ideal for Many Uses
- Prevents Surface Rust
- Paint and Body Applications
- For Use with OEMTOOLS™ 24815 Abrasive Blast Cabinet



Glass Bead Medium Grit Media, 25 Lbs. **SHARK USA**
 SKU 010139 **49⁹⁹**
 SHA13078



**BONUS \$12.99 ON BENCH VISE
JAW PADS WITH PURCHASE OF
HEAVY DUTY BENCH VISE - 24218**

**FREE OVERNIGHT
SHIPPING
WITH MOST ORDERS
SEE PAGE 3 FOR DETAILS**

Shop Press

**20 Ton Air/ Hydraulic
Shop Press with Gauge**
SKU 544793
24812 **599⁹⁹**

- Includes Press Blocks
- Pressure Gauge Provides Accurate Pressure Readings
- Ram Moves Side to Side for Versatility
- Measurement Between Uprights: 21-1/8"
- Working Range 0" - 40-1/2"



**12 Ton Hydraulic Shop
Press with Gauge**
SKU 544790
24811 **429⁹⁹**

- Includes Press Blocks
- Pressure Gauge Provides Accurate Pressure Readings
- Measurement Between Uprights: 20"
- Working Range 0" - 36-1/8"



20 Ton Shop Press
SKU 300134
24810 **419⁹⁹**

**Stronger Compared to Similar Lighter
Weight Shop Presses on the Market**

- Includes Press Plates
- Remove and Install Bearings, Gears, U-Joints, Bushings, Ball Joints and Pulleys
- Multi-Position Bed for Work Height Adjustment
- Max. Height: 31.5"
- Max. Width: 21.75"



**Super
Heavy Duty
H-Frame
Press Weighs
Over 250 Lbs.**

OEM TOOLS™

Press Support Accessories

OEM TOOLS™

Universal Press Support

SKU 804487
24809 **229⁹⁹**

- Adds Multiple Points of Contact to Improve Safety and Stability While Using Your Shop Press
- Offers Nearly Endless Adjustments to Fit Irregularly Shaped Items
- CNC Machined Anodized Aluminum
- Laser Etched Position Markings for Durability
- Black Oxide Coated Cr40 Steel Hardware



Color May Vary

Shop Press Pin Set

SKU 544794
24813 **99⁹⁹**

- Includes Set of 8 Press Pins, 2-20 Ton Capacity, with 25 mm Ram Adapter Capacity
- Suitable for Use with Hydraulic Ram Style Shop Presses Which Have a Female Ram Assembly Diameter of 25 mm and are Secured with a Bolt
- Includes Mountable Bracket
- Works with OEMTOOLS™ 24811 and 24812
- Not for Use with Bottle Jack Style Shop Presses

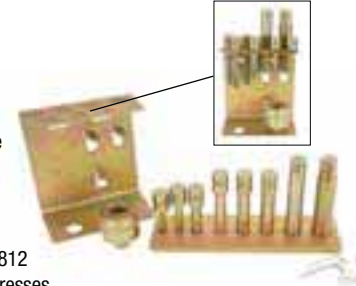

Vises

6" Heavy Duty Bench Vise with Swivel Base

SKU 751654
24218 **89⁹⁹**

- Machined Replaceable Steel Jaws
- Machined Anvil, Permanent Pipe Jaws
- Full 360° Swivel Base
- Clamping Strength: 300 Lbs.

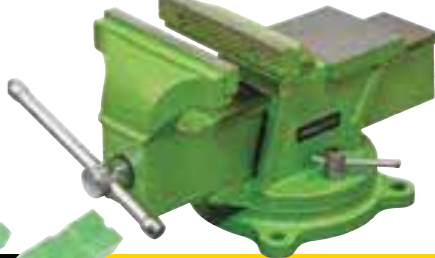

OEM TOOLS™

BONUS VALUE: \$12.99

6" Bench Vise Jaw Pad
SKU 177719 | 24244



With Purchase of:
**6" Heavy Duty Bench
Vise with Swivel Base**
SKU 751654 | 24218

Offer Good Through March 31, 2019 - While Supplies Last

**4-1/2" Light Duty Bench Vise
with Swivel Base**

SKU 751645
24216 **39⁹⁹**

- Machined Replaceable Steel Jaws
- Machined Anvil, Permanent Pipe Jaws
- Full 360° Swivel Base
- Clamping Strength: 100 Lbs.



**4" Heavy Duty Bench Vise
with Swivel Base**

SKU 751643
24217 **49⁹⁹**

- Machined Replaceable Steel Jaws
- Machined Anvil, Permanent Pipe Jaws
- Full 360° Swivel Base
- Clamping Strength: 200 Lbs.

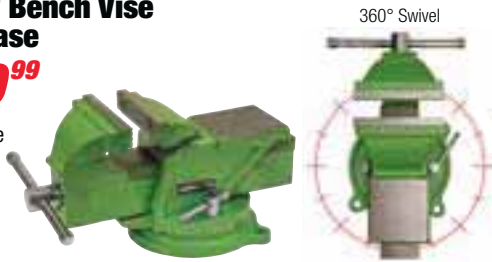

360° Swivel

Vacuums

**5 Gallon Stainless Steel
Wet/Dry Vacuum Cleaner**

SKU 912310
BIG55274 **69⁹⁹**

- Provides Powerful Suction
- Rugged Stainless Steel Construction
- Features (4) Casters for Easy Transport
- Includes: (1) 5' Hose, (3) Extension Wands, (1) Non-Woven Bag, (1) Sponge Filter, (1) Crevice Tool, and (1) Disposable Filter Bag
- Replacement Filter Bags: Kubota® KUB54100 Filter Bags
- Dry Cartridge Filter KUB55022 or Wet Sponge Filter KUB12049 Can Be Used



**Big Vac 8 Gal
Wet/Dry Vacuum**

SKU 750618
BIG55271 **99⁹⁹**

- 5 HP Peak Motor
- Rear Blower Port Design
- Positive Lock-On Hose System to Prevent Unexpected Disconnections
- Swiveling Casters Provide Easy Movement in Any Direction
- Carry Handle and Cord Wrap Design
- Includes These Accessories: 7 Ft Flexible Hose, 2 Extension Wands, Crevice Nozzle, Sofa/Seat Brush, Floor Brush with Switch, Wet Sponge Filter, Dry Cartridge Filter, Dust Bag
- Dry Cartridge Filter KUB55022 or Wet Sponge Filter KUB12049 Can Be Used



BigVac

**Big Vac 14.5 Gallon Leaf
Blower Wet Vacuum**

SKU 750624
BIG55275 **139⁹⁹**

- 5 HP Peak Motor
- Detachable Blower with Blower Tube and Power Cord
- Swiveling Casters Provide Easy Movement in Any Direction
- Includes These Accessories: 5 Ft Extra Large Hose, 2 Extra Wide Extension Tubes, Accessory Adaptor, Wet Floor Brush, Hepa Filter, Crevice Tool and Blower Tube
- Wet Sponge Filter KUB12049 Can Be Used



**Big Vac 12 Gallon
Wet/Dry Vacuum**

SKU 750621
BIG55272 **149⁹⁹**

- 6 HP Peak Motor
- Stainless Steel Tank - 12 US Gallons
- Rear Blower Port Design
- Soft Grip Push Handle
- Large Rear Wheel and Utility Base
- Carry Handle and Cord Wrap Design
- Includes These Accessories: 7 Ft Flexible Hose, Metal Extension Tube, Floor Brush with Switch, Crevice Nozzle, Dry Cartridge Filter and Wet Sponge Filter
- Dry Cartridge Filter KUB55022 or Wet Sponge Filter KUB12049 Can Be Used



Dry Cartridge Filter

SKU OUTSIDE BUY/EPO
KUB55002 **24⁹⁹**

- Fits Kubota and Big Vac Vacuums



Wet Sponge Filter

SKU OUTSIDE BUY/EPO
KUB12049 **10⁹⁹**

Available via Outside Buy/EPO, Call 1-877-298-6651 for Ordering Instructions



Bearing Separators

OEM TOOLS™

**Bearing Splitter,
1/4" to 15/16"**

SKU 514005
27231 **19⁹⁹**

- Thread of Tapped Holes in Adapter: 5/16" - 18
- Distance Between Adjusting Screws: 1-11/16"



**Bearing Splitter,
1/2" to 4-5/8"**

SKU 514006
27232 **59⁹⁹**

- Razor Edges Wedge Between Parts and Securely Holds Tool
- Thread of Tapped Holes in Adapter: 5/8" - 18
- Distance Between Adjusting Screws: 4-3/8"



**5 Ton Bar-Type Puller/Bearing
Separator Set**

SKU 347218
27236 **99⁹⁹**

- Separator Tools are Used with Bar Puller and Legs for a Wide Variety of Pulling Jobs
- Set Includes 2" and 3" Bearing Splitters, Four Sets of Hex Push-Puller Legs and a Bar-Type Puller Head with a 9/16" Forcing Screw
- Use Separately or with Other Pullers or Tools Drop-Forged and Heat-Treated

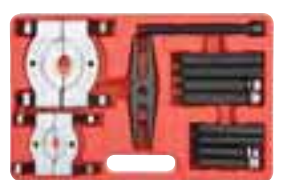

**Bearing Splitter
Combo Set**

SKU 087318
OTC1183 **349⁹⁹**

- Contains 4 of OTC's Most Popular Splitters Plus a Pulley Pulling Attachment in a Rugged Storage Case
- Includes 1121, 1122, 1123 and 1130 Bearing Splitters
- Also Includes 679 Pulley Attachment



OTC

Inverter Generators

2000 Watt Stackable Inverter Generator

SKU 020739
CHM735361 **584⁹⁹**

- Run/Start Watts 1700/2000
- Clean Power (<3% THD) - Clean Electricity for Powering Sensitive Electronics
- Operates at 53 dBA from 23 Feet
- Runs Up to 9.5 Hours on a Full Tank of Gas
- Parallel Capability - Connect with Another Inverter for Increased Power
- Space Saving Stackable Design with Carrying Handles

Carb Compliant



3100 Watt RV Ready Portable Inverter Generator

SKU 757074
CHM755311 **1,004⁹⁹**

- Quiet, Lightweight and Portable - Operates at 58 dBA and Weighs Less than 99 Lbs. with Wheel Kit
- 3100 Starting Watts, 2800 Running Watts with Up to 8 Hours Run Time on a Full Tank of Gas
- RV Ready Outlets - 120V 30A RV, (2)120V 20A Household, 12V DC Outlets
- Champion Support - 3 Year Limited Warranty with Free Lifetime Technical Support

Carb Compliant



73500i 30A Parallel Kit for Linking 2 Stackable Inverter Generators 1600 to 2000 Watts

SKU 757076
CHM735001 **85⁹⁹**



Gas Powered Generators

3500 Watt Portable Generator

SKU 020730
CHM46596 **404⁹⁹**

- Run/Start Watts 3500/4000
- RV Ready - Equipped with a Standard 30A RV Outlet
- Volt Guard™ Protects Your Appliances from Power Surges
- Runs Up to 12 Hours on a Full Tank of Gas
- Starts Easily in Cold Weather
- Durable Steel Frame
- 49 State EPA Compliant
- Champion Support - 3 Year Limited Warranty with Free Lifetime Technical Support
- Intelligauge to Monitor Power Output and Maintenance Intervals



Not Available for Sale in California

6500 Watt Portable Generator

SKU 020745
CHM100109 **769⁹⁹**

- Run/Start Watts 6500/8125
- Volt Guard™ - Protects Your Appliances from Power Surges
- Intelligauge to Monitor Power Output & Maintenance Intervals
- Runs Up to 11 Hours on a Full Tank of Gas
- Outlets: 120V/240V 30A Locking, 120V 20A GFCI Duplexes with Cover Outlets
- CARB Compliant
- Champion Support - 3 Year Limited Warranty with Free Lifetime Technical Support



Carb Compliant

GP3250 Portable Generator

SKU 973238
GENGP3250 **504⁹⁹**

- Rated Watts: 3,250
- Run Time at 1/2 Load: 9.7 Hours
- Outlets: (1) 120V 20A 5-20R Duplex Outlet; (1) 120/240V 20A L14-20R Twist-Lock Outlet
- Gas Tank: 3.5 Gallons
- Low Oil Level Shutdown Automatically Safeguards Engine



Carb Models Available

WARRANTY: 2 Years Parts and 2 Years Labor
Not Available for Sale in California

GP15000 Gas Powered Portable Generator

SKU 568403
GENGP15000E **3,114⁹⁹**

- 16 Gallon Fuel Tank Runs the Generator Continuously Up to 10 Hours at Half Load; Idle Control for Improved Fuel Efficiency
- OHVI Engine is Designed for Extended Run Times for Use at Jobsites or for an Emergency Backup Power Source
- Circuit Breaker Protected Outlets for Added Safety



WARRANTY: 2 Years Parts and 2 Years Labor
Not Available for Sale in California

Gas Powered Electric Start Generators

3500 Watt with Wireless Remote Electric Start

SKU 775503
CHM46539 **579⁹⁹**

- RV Ready - Equipped with a Standard 30A RV Outlet, Enough Power to Start and Run a 15,000 BTU RV Air Conditioner
- 4000 Starting Watts, 3500 Running Watts with Up to 12 Hours Run Time on a Full Tank of Gas
- Powered By a Reliable 196cc Champion Engine with Wireless Remote Start, Up to 80 Ft. Away
- Outlets: 120V 30A Locking, 120V 30A RV, (2) 120V 20A Household Outlets All Secured By Volt Guard™—Protects Your Appliances from Power Surges
- Champion Support - 3 Year Limited Warranty with Free Lifetime Technical Support



Carb Compliant

GP6500E Gas Powered Portable Electric Start Generator

SKU 568402
GENGP6500E **1,044⁹⁹**

- Generac's 389cc OHV Engine with Splash Lubrication Provides a Long Engine Life
- Low-Oil Shutdown Automatically Safeguards Engine from Damage
- Hour Meter Tracks Maintenance Intervals



WARRANTY: 2 Years Parts and 2 Years Labor
Not Available for Sale in California

7500 Watt Portable Electric Start Generator

SKU 020758
CHM100219 **949⁹⁹**

- Run/Start Watts 7500/9375
- Touch Start - Battery Included for Push Button Electric Start
- 25' Power Cord Included
- Volt Guard™ Protects Your Appliances from Power Surges
- Runs on Up to 8 Hours on a Full Tank of Gas
- Intelligauge to Monitor Power Output & Maintenance Intervals
- Champion Support - 3 Year Limited Warranty with Free Lifetime Technical Support



Carb Compliant

9200 Watt Portable Electric Start Generator

SKU 020759
CHM100110 **1,159⁹⁹**

- Run/Start Watts 9200/11500
- 459cc - Champion OHV Engine
- Touch Start - Push-Button Electric Start
- Equipped with a Standard 30A RV Outlet
- Volt Guard™ Protects Your Appliances from Power Surges
- Runs Up to 10 hours on a Full Tank of Gas
- Intelligauge to Monitor Power Output & Maintenance Intervals
- CARB Compliant
- Champion Support - 3 Year Limited Warranty with Free Lifetime Technical Support



Carb Compliant

12000 Watt Portable Generator with Electric Start

SKU 757111
CHM100111 **2,214⁹⁹**

- Touch Start - Push-Button Electric Start (Battery Included)
- 15000 Starting Watts, 12000 Running Watts with Up to 9 Hours Run Time on a Full Tank of Gas
- Powered By a Reliable 717cc Champion V-Twin Engine
- Durable Steel Frame with a Lift Hook for Safe and Easy Transport
- Covered Outlets - 120V/240V 50A, 120V/240V 30A Locking, 120V 30A Locking, (4) 120V 20A GFCI Protected Household Outlets All Secured By Volt Guard™—Protecting Your Appliances from Power Surges
- Champion Support - 3 Year Limited Warranty with Free Lifetime Technical Support



Carb Compliant

GP17500E Gas Powered Portable Electric Start Generator

SKU 626138
GENGP17500E **3,304⁹⁹**

- 16 Gallon Fuel Tank Runs the Generator for Up to 10 Hours at Half Load
- 992 cc Engine Runs on Gasoline to Provide Dependable Power
- Circuit Breaker Helps Protect the Generator and Connected Appliances from Damage



WARRANTY: 2 Years Parts and 2 Year Labor
Not Available for Sale in California

Dual Fuel Powered Generators

3800 Watt Dual Fuel Electric Start Generator

SKU 020777
CHM76533 **634⁹⁹**

- Run/Start Watts 3800/4750 (Gasoline)
- Dual Fuel - Runs on Gas or Propane Straight Out of the Box
- Touch Start - Battery Included for Push-Button Electric Start
- Equipped with a Standard 30A RV Outlet
- Volt Guard™ Protects Your Appliances from Power Surges
- Runs Up to 9 Hours on a Full Tank of Gas or 10.5 Hours on a 20 Lb. Propane Tank
- Champion Support - 3 Year Limited Warranty with Free Lifetime Technical Support



Carb Compliant

5500 Watt Dual Fuel Portable Generator

SKU 775501
CHM100231 **844⁹⁹**

- Dual Fuel - Runs on Gas or Propane Straight Out of the Box
- 6900 Starting Watts, 5500 Running Watts Up to 9 Hours
- Run Time on a Full Tank of Gas and Up to 10.5 Hours on a 20 Lb. Propane Tank
- Powered By a Reliable 389cc Champion Engine
- Outlets: 120V/240V 30A Locking, (2) GFCI 120V 20A Duplex Outlets All Secured By Volt Guard™—Protects Your Appliances from Power Surges
- Champion Support - 3 Year Limited Warranty with Free Lifetime Technical Support



Carb Compliant

7500 Watt Dual Fuel Generator with Electric Start

SKU 020752
CHM100165 **1,054⁹⁹**

- Run/Start Watts 7500/9375 (Gasoline)
- Dual Fuel - Runs on Gas or Propane Straight Out of the Box
- Touch Start - Battery Included for Push-Button Electric Start
- Volt Guard™ Protects Your Appliances from Power Surges
- Runs Up to 8 Hours on a Full Tank of Gas or 5.5 Hours on a 20 Lb. Propane Tank
- Intelligauge to Monitor Power Output and Maintenance Intervals
- Champion Support - 3 Year Limited Warranty with Free Lifetime Technical Support



Carb Compliant

WE OFFER A FULL LINE OF GENERATORS AVAILABLE FROM



877-AZTool1
877-298-6651
 Hablamos Español
AZtool1.com

Pressure Washers

2,900 PSI Power Washer

SKU 004110 GEN6882 **434⁹⁹**

- PowerDial™ Ergonomic Spray Gun Allows You to Easily Adjust the Pressure Needed Between 4 Different Tasks: Car, Wood, Concrete and Soap
- Soap Blaster for Soaping 3X Farther, Saving You Time and Steps
- Generac 196cc OHV Engine Delivers Maximum Cleaning Performance
- Includes 30' High Pressure Flex Hose



Carb Compliant

WARRANTY: 3 Years Parts and 3 Years Labor

3,100 PSI Power Washer

SKU 202417 GEN7019 **509⁹⁹**

- Ergonomic Spray Gun with Integrated PowerDial™
- Powerful 196cc Generac OHV Engine
- Axial Cam Pump with Easy-Access Hose Connections
- Oversized Never-Flat Tires
- Convenient Detergent Tank
- Quick-Change Nozzle Tips – Includes 4 tips: 0°, 25°, 40°, and Soap Applicator
- 25' High Pressure Hose – Connects to the Rear of the Spray Gun for Maximum Convenience



Carb Compliant

WARRANTY: 2 Years Parts and 2 Years Labor

4,200 PSI Commercial Pressure Washer

SKU 570263 GEN6565 **1,189⁹⁹**

- Powerful 420 cc Generac Horizontal Shaft Engine with Low Oil Shutdown
- Professional Grade Triplex Pump with Ceramic Coated Pistons, Designed for Long Life
- Pressure Control Valve Provides Complete Control of Water Pressure
- 3/8" x 50' Steel Reinforced Rubber Hose



These Units are Not for Sale in California. Call for Pricing on CARB Compliant Models.

WARRANTY: 3 Years Parts and 3 Years Labor

Exhaust Hoses

Crushproof Door Port for 2-1/2" Hose (Rubber)

SKU 977551 ACSDF25 **34⁹⁹**

- Rubber Garage Door Port Adapter
- Designed for 2-1/2" ID



Crushproof Door Port for 3" Hose (Aluminum)

SKU 977552 ACSADF30 **39⁹⁹**

- Aluminum Port Allows Hose to Be Vented Through the Door



Crushproof Door Port for 4" Hose (Aluminum)

SKU 977554 ACSADF40 **54⁹⁹**



Crushproof Flarelock Hoses

- Made Exclusively for Cars and Small Trucks
- End is Flared to Permit Connection of Two or More Links at a Time

2.5" x 11'

SKU 977557 ACSFLT250 **99⁹⁹**

3" x 11'

SKU 977559 ACSFLT300 **119⁹⁹**

3.5" x 11'

SKU 977589 ACSFLT350 **169⁹⁹**

4" x 11'

SKU 977590 ACSFLT400 **189⁹⁹**



CRUSHPROOF TUBING COMPANY

Crushproof 2.5" Service Station Kit

SKU 977547 ACSOSS25 **219⁹⁹**

Includes:

- 2 Each - 4' x 2-1/2" Hoses
- 1 Each - 6' x 2-1/2" Hose
- 1 Each - 2-1/2" Rubber "Y" Connector
- 2 Each - Straight Tailpipe Adapter, Hook and Chain
- 1 Each - Splice Connector



3" Service Station Kit

SKU 977548 ACSOSS30 **219⁹⁹**

Crushproof 2.5" Y-Assembly Kit with F250 Adapter

SKU 977549 ACSYA250 **149⁹⁹**

- Designed for Connecting a Single Hose to Vehicles with Dual Exhaust Systems



3" Y-Assembly Kit with F300 Adapter

SKU 977550 ACSYA300 **169⁹⁹**



Crushproof Bell Hose Adapters

- Designed for Easy Adapting to All Sorts of Tailpipes
- Connects with Ball and Snap

2-1/2" Adapter

SKU 977544 ACSRA250 **37⁹⁹**



3" Adapter

SKU 977545 ACSRA300 **39⁹⁹**



Crushproof Straight Tailpipe Adapters with Hook and Chain

2.5" Straight Tailpipe Adapter with Hook and Chain ...SKU 977591 ACSF250.. **24⁹⁹**

3" Straight Tailpipe Adapter with Hook and ChainSKU 977539 ACSF300.. **34⁹⁹**

3.5" Straight Tailpipe Adapter with Hook and Chain ..SKU 977540 ACSF350.. **44⁹⁹**

4" Straight Tailpipe Adapter with Hook and ChainSKU 977541 ACSF400.. **64⁹⁹**

3" x 6" Oval Tailpipe Adapter.....SKU 977542 ACSF475.. **44⁹⁹**

3.5" x 8.5" Oval Tailpipe Adapter.....SKU 977543 ACSF575.. **54⁹⁹**



Hot Water Pressure Washers

HSP 3500 PSI 3.3 GPM

SKU 597220 MTMHSP35043MH **4,299⁹⁹**

- Burner Utilizes a Patented Electro Magnetic Firing (EMF) System, Eliminating the Need for a 12V Battery
- Pump Features a Low Pressure Detergent Injector
- Temperature Rise: 150°F (66°C); Max Outlet Temperature: 200°F
- Unit Includes: 4 Quick Connect Nozzles, 50' x 3/8" Wire-Braided High Pressure Hose, Insulated Trigger Gun with Safety Lock and Adjustable Pressure Insulated Dual Lance
- CSA Certified - US and Canada



HSE 1500 PSI 2.0 GPM

SKU 597218 MTMHSE15020MM **2,799⁹⁹**

- Features a Top-Fired Heat Exchanger and Totally Enclosed, Fan-Cooled Electric Motor
- Temperature Rise: 150°F (66°C); Max Outlet Temperature: 200°F
- Unit Includes: 4 Quick Connect Nozzles, 50' x 3/8" Wire-Braided High Pressure Hose, Insulated Trigger Gun with Safety Lock and Adjustable Pressure Insulated Dual Lance
- 35' Power Cord
- CSA Certified - US and Canada



Fluid Handling Equipment

SEE FULL LINE OF MAXXMARKA ON AZTOOL1.COM

FluidPRO® PSX-3 Power Steering Fluid Exchange System

SKU 850063 MSSPSX3 **1,029⁹⁹**

- Multiple Power Steering Fluid Capability
- Dual Diaphragm-Type Pumps for Speedy Service Times of 5-15 Minutes
- Quick and Easy Changeover Between Different Power Steering Fluid Types Allows Improved Technician Productivity



Fluid not included



FluidPRO® DFX-1 for Differential Fluid Exchange

SKU 572560 MSS4458000100 **1,339⁹⁹**

- Services All Gear Oils Including Synthetic for Increased Compatibility
- Automatic Operation for Improved Technician Efficiency
- Valved-Hose Ends to Prevent Fluid Spill and Ensure Clean Operation

Fluid not included



FluidPRO® ATX-2+Boost Transmission Fluid Exchanger

SKU 573105 MSS4008000800 **3,819⁹⁹**

- Fully Automatic Operation
- Precision Fluid Measurement to Minimize Technician Input
- Digital Weight Scale Technology for Accurate Fluid Exchange
- Transmission Pressure Diagnostics

Fluid Not Included



FluidPRO® ATX+Boost/PS Combo Power Steering/Transmission Unit

SKU 572461 MSS4158001400 **4,429⁹⁹**

- PSX-3 Mounted on Back of ATX-2 Machine
- Fluid Flow Direction Indicator Verifies Correct Hook-Up
- Transmission Diagnostic Pressure Gauge
- Process Time: 3 to 6 Minutes Average Full Exchange

Fluid Not Included

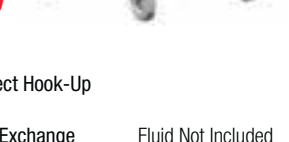

Power-Maxx Power Steering Fluid Exchange w/Startup Kit

SKU 032796 MXMMX1COMBO **1,989⁹⁹**

- Exchanges Power Steering Fluid in Less Than 3 Minutes
- For Use on Cars and Trucks
- No Hoses to Disconnect
- Eliminates Overflow and Spills
- Startup Kit Includes 6 Each Amber and Red Kits of Power Steering Treatment and Power Steering Fluid



Power-Maxx Power Steering Exchange Machine only

SKU 003626 MXMMX1 **1,769⁹⁹**

Trans-Maxx Transmission Flush Machine w/Startup Kit

SKU 202001 MXMMXA9COMBO **3,479⁹⁹**

- Exchanges Automatic Transmission Fluid Directly from the Transmission
- For Cars, Trucks, SUVs, Boats and RVs
- Eliminates Spills



Startup Kit Includes 12 Bottles of Transmission Flush and 12 Bottles Transmission Conditioner



Trans-Maxx Transmission Flush Exchange Machine only

SKU 912330 MXMMXA9 **3,099⁹⁹** Transmission Fluid Not Included

Trans-Tech 4 Plus

SKU 305858 MVC500-1125B **4,069⁹⁹**

- Automatic, In-Line Exchange Through Vehicle Cooler Line
- ATF Exchange Through Vehicle Transmission Dipstick
- Drain Pan Feature
- 26 Quart New Fluid Reservoir
- High Volume Pump for Rapid and Efficient Service
- Comes with Standard Set of Adapters



Fluid Not Included



FluidPRO® ATX-3+Boost/PS Combo Power Steering/Transmission Fluid Exchanger

SKU 572537 MSS4158001900 **4,949⁹⁹**

- PSX-3 Mounted on Back of ATX-3 Machine
- Fluid Flow Direction Indicator Verifies Correct Hook-Up
- Transmission Diagnostic Pressure Gauge
- Process Time: 3 to 6 Minutes Average Full Exchange
- Includes Dipstick Service Mode

Fluid Not Included



FluidPRO® ATX-3+Boost Transmission Fluid Exchanger

SKU 574434 MSS4008000900 **4,429⁹⁹**

- "Dipstick" or "Cooler" Mode Selector
- Fully Automatic Operation
- Precision Fluid Measurement to Minimize Technician Input
- Digital Weight Scale Technology for Accurate Fluid Exchange
- Transmission Pressure Diagnostics

Fluid Not Included

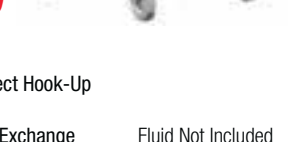

WELDING

Welding/ Cutting

Stick Welder 115V 70 Amp

SKU 814387
24818 **199⁹⁹**

- Convenient 120V AC Input
- DC Inverter Powered for Improved Efficiency and Control
- Lightweight and Portable
- Welds Mild Steel, Stainless and Cast Iron
- Includes: Welder, 5' Ground Cable and Clamp, 6.5' Electrode Cable and Rod Holder, Shoulder Strap, Mask and Combo Brush / Hammer



OEM TOOLS™

Plasma Cutter 120/230V 40 Amp

SKU 819234
24814 **469⁹⁹**

- Cuts Mild Steel, Copper, Brass, Stainless and Aluminum
- Capacity Up to 8mm @110v and 12mm @220v
- Dual Voltage Compatible Works with 120 and 230V AC
- Compact and Portable
- Includes Torch, Ground Cable, 120V Adapter Cord, Wire Brush

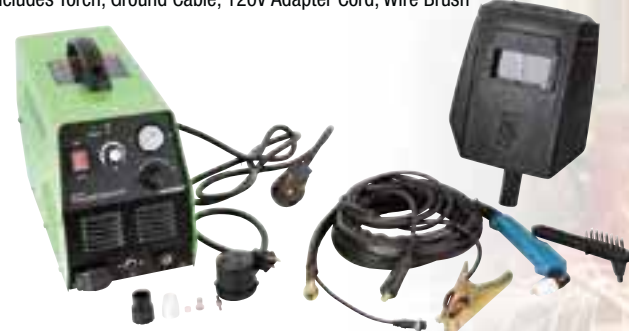

OEM TOOLS™



Spot Welder 120V

SKU 814396
24819 **189⁹⁹**

- 120V AC Input Power
- Spot Welds Uncoated Mild Steel Including Galvanized and Stainless
- Includes 6" Tongs and Replacement Tips



OEM TOOLS™

FP-95 Flux Cored Welding System

SKU OUTSIDE BUY/EPO
THE1444-0322 **499⁹⁹**

- Portable FP-95 MIG/Flux-Cored Wire Welder
- Operates from Standard Household Outlet and Delivers 90 Amps
- Includes Tweco® Gun, Return Cable and Clamp, and .035" Spool of Flux-Cored Wire
- Easy to Use Key Setup Chart
- Gas Solenoid Not Included



Firepower

MST 140i Welder

SKU 688017
THE1444-0870 **749⁹⁹**

- Includes: Firepower MST 140i Power Supply, Firepower 140 Amp MIG Gun, Firepower Argon/CO² Pressure Regulator/Gauge and Hose, Electrode Holder and Ground Clamp, Drive Roll and Contact Tips, 15-20 Amps Power Adapter, Shoulder Strap and Multi-Language Instructional CD



Firepower

MST 180i Welder

SKU 688020
THE1444-0871 **1,059⁹⁹**

- Includes: Firepower MST 180i Power Supply, Firepower 180 Amp MIG Gun, Firepower Argon/CO² Pressure Regulator/Gauge and Hose, Electrode Holder and Ground Clamp, Drive Roll and Contact Tips, Standard 230V Plug, Shoulder Strap and Multi-Language Instructional CD



Firepower

MST 220i Welder

SKU 687990
THE1444-0872 **1,399⁹⁹**

- Includes: Firepower MST 200i Power Supply, Firepower 220 Amp MIG Gun, Firepower Argon/CO² Pressure Regulator/Gauge and Hose, Electrode Holder and Ground Clamp, 230V-115V Adapter Plug and Cable, Drive Roll and Contact Tips and CD with Multi-Language Operating Instructions



Firepower

Plasma Cutter CUTMASTER® 42

SKU 301766
THE1-4200 **1,519⁹⁹**

- Includes: CUTMASTER 42 Power Supply, All New SL40 Torch, Safety Gloves and Glasses, Instructional Plasma Cutting DVD, Consumables Set, Heavy Duty Carrying Case and Power Plug Adapters



Firepower



\$100

Factory Cash Back Rebate! or Welding Cart

VALID JANUARY 1 - MARCH 31, 2019
For Details Go to www.firepoweronline.com/promotions

Welding Accessories

Basic Welding Cart

SKU 849600
THE1444-0900 **149⁹⁹**

- Sturdy Handle Makes Transporting Welders Easy
- Designed for Most Portable Welding/Cutting Systems
- Rugged Solid Steel Construction
- Easy-Rolling 8 Inch Diameter Wheels
- 3 Inch Front Mounted Casters



Firepower

TIG® Torch and Accessories

SKU 295859
THEW4013802 **189⁹⁹**

(Required for TIG Welding)

- TIG Torch, 17V, 13', 8 Pin and Accessory Kit with 1/16", 3/32", 1/8" Thoriated Tungstens
- 1/16", 3/32", 1/8" Collets; 1/16", 3/32", 1/8" Collet Bodies
- No. 5, 6, 7 Alumina Nozzle; Short Back Cap; Long Back Cap



*TIG welding requires purchase of THEW4013802 Accessory Kit

Firepower

160 Amp MIG Spool Gun

SKU 434724
THE1444-0894 **354⁹⁹**

- Interfaces with Firepower MST 180i and 220i 3-in-1 Welders
- Rated 20% Duty Cycle and 160 Amps
- Includes Carrying Case



Firepower

250 Piece Welding Stud Assortment

SKU 271198
68130 **18⁹⁹**

- 250 Piece, 2" x 3/40" Size
- Use with Stud Welder or Stud Gun
- Copper Coated Steel Construction



HARDWARE MACHINERY

Leather Welder's Gloves

SKU 972316
THE14230051 **29⁹⁹**



Firepower

ELECTRODES

E6011 1/8" Electrode 5 Lbs.

SKU 988902 | THE14400106 **24⁹⁹**

E7018 1/8" Electrode 5 Lbs.

SKU 988904 | THE14400186 **24⁹⁹**



Firepower

WIRE

MIG Solid Wire E70S6 - .023 - 2 Lbs. SKU 459160 | SHA12000 **19⁹⁹**

MIG Solid Wire E70S6 - .023 - 11 Lbs. SKU 459162 | SHA12001 **39⁹⁹**

MIG Solid Wire E70S6 - .030 - 11 Lbs. SKU 459164 | SHA12003 **29⁹⁹**

MIG Solid Wire E70S6 - .035 - 33 Lbs. SKU 459173 | SHA12007 **69⁹⁹**

Flux Core Welding Wire - .030 - 2 Lbs. SKU 459175 | SHA12008 **29⁹⁹**

Flux Core Welding Wire - .035 - 2 Lbs. SKU 459180 | SHA12009 **29⁹⁹**



TIPS (25 PACK)

Lincoln MIG Contact .030 Tips SKU 343402 | SHA12874 **29⁹⁹**

Lincoln MIG Contact .035 Tips SKU 343403 | SHA12875 **29⁹⁹**

Miller MIG Contact .030 Tips SKU 343404 | SHA12877 **29⁹⁹**

Benzel and Tweco MIG Contact - .023 Tips SKU 343399 | SHA12937 **24⁹⁹**

Benzel and Tweco MIG Contact - .030 Tips SKU 343401 | SHA12938 **29⁹⁹**





FREE OVERNIGHT SHIPPING
WITH MOST ORDERS
SEE PAGE 3 FOR DETAILS

Welding/Cutting

Oxyfuel Tote with Tanks

SKU **OUTSIDE BUY/EPO**
THE0384-0977 **519⁹⁹**

- Complete Portable Oxy-Acetylene Welding and Cutting System
- Suitable for Light Duty Fusion Welding Braze Welding Brazing and Cutting Applications
- Simple to Use Color Coded Rear Mount Regulators with High Contrast Gauges
- Cuts 1/8" to 3" (With Optional Tips); Cuts 1/2" Out of the Box
- Welds up to 1/4" (With Optional Nozzles); Cuts 1/8" Out of the Box

Available via Outside Buy/EPO,
Call 1-877-298-6651 for Ordering Instructions



250 Series OxyFuel Medium Duty Acetylene Outfit

SKU **573205**
THE0384-2571 **269⁹⁹**

- Cutting Torch and Handle are Ready for Multiple Gas Options: Oxy-Acetylene, Propane, Butane, Natural & LP Gases, & Propane
- Welds Up to 1/2" Steel
- High Capacity: Cut 1/8 In. (3.2 mm) to 5 In. (127 mm)
- High Contrast Gauges are Easy to Use
- Ergonomic Color Coded Knobs (Acetylene & Oxygen)
- Includes Handle, Cutting Attachment, Gauges, Welding Nozzle, Cutting Tip, Eye Protection and Striker



Welding Helmets

Auto Darkening Welding Helmet

SKU **362974**
24357 **49⁹⁹**

- TIG Rated Variable Shade 9-13
- Viewing Area: 3.54" x 1.37"
- Battery Powered with Solar Assist
- Includes Replacement Cover Lenses



Auto Darkening Welding Helmet with Grinding Function

SKU **347233**
24358 **79⁹⁹**

- Variable Shade 9-13, Variable Sensitivity and Delay Controls
- Viewing Area: 3.62" x 1.65"
- Battery Powered with Solar Assist
- Includes Replacement Cover Lenses CE, ANSI Z87.1, CSA
- Z94.3, AS/NZS Approved



Stars and Stripes Darkening Welding Helmet

SKU **850068**
THE1441-0087 **109⁹⁹**

- Variable Shade - Adjustable Welding Shade Levels from 9 to 13
- "Welding" or "Grinding" Selection for Process Mode
- Solar-Powered - So You Don't Have to Worry About Changing Batteries - Ever



Tubing Benders

Blue Bullet Pipe Bender with B2 Die Package

SKU **015341**
BENBB2 **6,639⁹⁹**

- Two Separate End-Finishing Units at Rear for All Necessary Flaring and Expanding
- Knee Control and Depth-of-Bend Degree Plate for Manual Bending Operations
- Integrated Power-Relief Control Valve
- Pass-through Cylinder Stem Passes Completely Through the Primary Frame
- Includes: BB-2 Tooling Package, Quick Release Bending and Finishing Dies, and High-Speed Clampless Swager and Internal Expander



Lift Gate Service

SKU **262533**
RANLIFTGATE **95⁰⁰**

User Set-Up Required

Card System Complete with Rotation Dial / Computer CD

SKU **298074**
BENCS-1 **639⁹⁹**

- Over 3,500 Cards on One CD
- 10,000 Bending Applications
- Includes: Rotation Dial for Standard and "Mirror Image" Bending



3" Die Kit (Optional)

SKU **095070**
BEN300-1 **889⁹⁹**



Please note that the CS-1 Card System does not ship with the Benders and must be purchased separately.

Soldering

Mechanic's Mini Torch

SKU **804655**
24353 **17⁹⁹**

- Designed for Light Welding, Auto Repair and Heating Material in Confined Spaces
- Adjustable Flame Lights Upside Down
- Auto Ignition, Refillable
- Safety Lock When Not in Use
- Butane Not Included

OEM TOOLS™



Mechanic's Torch

SKU **802236**
24354 **19⁹⁹**

- Designed for Auto Repair, DIY Household Repair and Professional Soldering, Micro Welding and Brazing
- Heavy Duty Piezo Ignition with Strong Flame
- ABS Grip
- CPSC Approved and Child Restraint Safety Latch
- Butane Not Included



Professional 3-in-1 Butane Micro Torch Kit

SKU **420339**
24356 **29⁹⁹**

- 3-in-1 Design Can Be Used as a Soldering Iron, Torch or Hot Air Blower without Iron Tip
- Micro Torch Kit Includes: Torch, Metal Tip Wicking Cup with Sponge, Heat-Shrink Deflector, Chisel Point Tip, Anvil Solder Tip, Needle Tip and Hot Air/Soldering Tip and Base
- Ideal for Use with Electrical Repair, Tin and Plastic Melting, Heat-Shrinkable Tubing, Auto Repair, Hobby Repair and Jewelry Repair
- Power Range: 30W - 125W
- Butane Not Included



Professional 3-in-1 Soldering Iron Kit

SKU **420338**
24355 **29⁹⁹**

- 3-in-1 Design Can Be Used as a Soldering Iron, Torch or Hot Air Blower without Iron Tip
- Soldering Iron Kit Includes: Soldering Iron, Metal Tip Wicking Cup with Sponge, Solder Wire, Protective Tip Cap, Heat-Shrink Deflector, Chisel Point Tip, Anvil Solder Tip, Needle Tip and Hot Air/Soldering Tip



Heat-Shrink Tube Sets

171 Piece Heat-Shrink Tube Set

SKU **420335**
68165 **19⁹⁹**

- Protection and Insulation of Components and Wires
- Protection Against Water and Moisture Ingress Preventing Corrosion
- Color Coordinated Sizes
- Quick and Simple to Shrink By Heat Gun



106 Piece Waterproof Heat Shrink Tube Set

SKU **420334**
68164 **29⁹⁹**

- Tubes Shrink to Fit Over Cable Splices and Can Be Used for Wire Harnessing, Covering, Marking and Bundling of Wires
- Adhesive Lined Inner Wall to Seal Out Moisture
- 3:1 Shrink Ratio
- Waterproof



90 Piece Waterproof Heat Shrink Terminal Set

SKU **462482**
68166 **79⁹⁹**

- 30 Ring Connectors
- 15 Butt Connectors
- 15 Tin Butt Connectors
- 15 Female Disconnects
- 15 Male Disconnects
- Re-Sealable Plastic Case



DID YOU KNOW?

We carry water pump and timing component kits.

Contact Your AutoZone® Commercial Sales Manager for Details

AIR COMPRESSORS

BONUS BONUS 24418 & 25837
WITH PURCHASE OF ANY OEMTOOLS
AIR COMPRESSORS BELOW

30 Gallon - 2 Stage Compressors

13 HP Horizontal with Honda Engine

SKU 110435
IRT2475F13GH **2,849⁹⁹**
• Gas Powered Honda Engine
• CFM: 25 @ 175 PSI
• Cast Iron Pump



Delivery Included

Lift Gate Service

SKU 262532
IRTLIFTGATE **80⁰⁰**

Startup Kit

SKU 970499 **139⁹⁹** In Stock - Ready to Ship
IRT32312936
• Includes: 2 Air Filter Elements, 2 Quarts
4 Cycle Engine Oil, 4 Liters of All Season Synthetic Lube
• Use of Kit Extends Compressor Pump Warranty to 2 Years

13 HP 30 Gallon Honda Gas Powered

SKU 592266
26105 **2,399⁹⁹**

- Heavy Duty Low RPM Cast Iron Pump
- 175 PSI Max Pressure
- 23 CFM @ 100 PSI
- 175 PSI Max Pressure
- Electric and Recoil Start



Lift Gate Service

SKU 295540
OEMLIFTGATE **80⁰⁰**

Delivery Included In Stock - Ready to Ship

OEMTOOLS
HONDA

BONUS VALUE **\$154.98**

Heavy Duty Composite Stubby Air Impact Wrench

SKU 087596 | 24418 **139⁹⁹**



PVC Air Hose - 3/8" x 50'

SKU 125076 **14⁹⁹**



With Purchase of:
13 HP 30 Gallon Honda Gas Powered
SKU 592266 | 26105

Offer Good Through March 31, 2019
While Supplies Last

13 HP Horizontal with Honda Engine

Chicago Pneumatic
HONDA

SKU 344741
CPTRCP1330G **2,549⁹⁹**

- 175 Max PSI
- CFM: 25.3 @ 100 PSI
- Premium Cast Iron and Aluminum Hybrid Pump
- 12V Electric and Recoil Starter Standard
- EZ Pull Type Tank Drain
- Oil Monitor
- Cold Start Valve
- Full 2 Year Warranty



Lift Gate Service

SKU 361260 **125⁰⁰**

Delivery Included

60 Gallon - 2 Stage Compressors

5 HP Vertical Air Compressor

SKU 210433
IRT240L5 **1,609⁹⁹**
• CFM: 14.3 @ 90 PSI
• Volts: 230 Single Phase
• Cast Iron Pump
• Factory Mounted and Wired Motor Starter



In Stock
Ready to Ship

Lift Gate Service

SKU 262532 | IRTLIFTGATE **80⁰⁰**

Startup Kit

SKU 970496 **139⁹⁹** Delivery Included
IRT32305880
• 4 Quarts Synthetic Lube and 2 Air Filters
• Use of Kit Extends Compressor Pump Warranty to 2 Years

5 HP 60 Gallon 230V Air Compressor

SKU 592262
26106 **1,099⁹⁹**

- 5 HP
- 1 Phase
- 15.3 CFM @ 100 PSI
- 165 PSI Max Pressure
- 2-Stage
- 2 Year Warranty on the Whole Machine



Lift Gate Service

SKU 295540 **80⁰⁰**

Delivery Included In Stock - Ready to Ship

OEMTOOLS

BONUS VALUE **\$154.98**

Heavy Duty Composite Stubby Air Impact Wrench

SKU 087596 **139⁹⁹**



PVC Air Hose - 3/8" x 50'

SKU 125076 **14⁹⁹**



With Purchase of:
5HP 60 Gallon Single Phase 230V Compressor
SKU 592262 | 26106

Offer Good Through March 31, 2019
While Supplies Last

5 HP Reciprocating Air Compressor

Chicago Pneumatic

SKU 344627
CPTRCP561VNS **1,099⁹⁹**

- CFM 15.3 @ 100 PSI
- Volts: 208 - 230 Single Phase
- 165 Max PSI
- Premium Cast Iron and Aluminum Hybrid Pump
- Magnetic Starter: Not Required
- Full 2 Year Warranty



Lift Gate Service

SKU 361260 **125⁰⁰**

Delivery Included

80 Gallon - 2 Stage Compressors

5 HP Vertical Air Compressor

SKU 095102
IRT2475N5V **2,434⁹⁹**
• CFM: 16.8 @ 175 PSI
• Volts: 230 Single Phase
• Cast Iron Pump
• Factory Mounted and Wired Motor Starter



In Stock - Ready to Ship

5 HP Premium Vertical Air Compressor

SKU 040598
IRT2475N5-P **2,544⁹⁹** In Stock - Ready to Ship
• Features of the Non-Premium Model Plus Air-Cooled Aftercooler
• Electronic Automatic Tank Drain
• Low Oil Level Protection Switch

7.5 HP Vertical Air Compressor

SKU 210434
IRT2475N7.5 **2,649⁹⁹**
• CFM: 24 @ 175 PSI
• Volts: 230 Single Phase
• Cast Iron Pump
• Factory Mounted and Wired Motor Starter



In Stock - Ready to Ship

7.5 HP Premium Vertical Air Compressor

SKU 040597
IRT2475N7.5P **2,619⁹⁹**
• Features of the Non-Premium Model Plus Air-Cooled Aftercooler
• Electronic Automatic Tank Drain
• Low Oil Level Protection Switch

Startup Kit

SKU 970496 **139⁹⁹**
IRT32305880
• 4 Quarts Synthetic Lube and 2 Air Filters
• Use of Kit Extends Compressor Pump Warranty to 2 Years

Lift Gate Service

SKU 262532
IRTLIFTGATE **80⁰⁰**

In Stock - Ready to Ship

5 HP 80 Gallon 230V Compressor

- Magnetic Starter Mounted and Wired
- Heavy Duty Low RPM Cast Iron Pump
- 18 CFM at 100 PSI
- 175 PSI Max Pressure
- 2-Stage
- 2 Year Warranty on the Whole Machine



Single-Phase

SKU 592257 **1,699⁹⁹**

3-Phase

SKU 592202 **1,699⁹⁹**

7.5 HP 80 Gallon 230V Compressor

- Magnetic Starter Mounted and Wired
- Heavy Duty Low RPM Cast Iron Pump
- 18 CFM at 100 PSI
- 175 PSI Max Pressure
- 2-Stage
- 2 Year Warranty on the Whole Machine

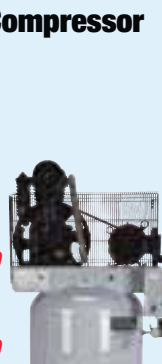

Single-Phase

SKU 592252 **2,099⁹⁹**

3-Phase

SKU 592239 **2,099⁹⁹**

Lift Gate Service

SKU 295540 **80⁰⁰**

Delivery Included In Stock - Ready to Ship

OEMTOOLS

BONUS VALUE **\$154.98**

Heavy Duty Composite Stubby Air Impact Wrench

SKU 087596 **139⁹⁹**



PVC Air Hose - 3/8" x 50'

SKU 125076 **14⁹⁹**



With Purchase of any:
SKU 592257 | 26100
SKU 592202 | 26101
SKU 592252 | 26102
SKU 592239 | 26103

Offer Good Through March 31, 2019
While Supplies Last

5 HP Vertical Air Compressor

Chicago Pneumatic

SKU 012631
CPTRCP-381VS **1,749⁹⁹**

- CFM: 18.5 @ 100 PSI
- Volts: 208 - 230 Single Phase
- 175 Max PSI
- Premium Cast Iron and Aluminum Hybrid Pump
- Mag Starter Included
- Solid Cast Iron Cylinders
- High Performance Inter-Cooler and Aftercooler
- Comes Ready to Run, No Startup Kit Required



5 HP Premium Vertical Air Compressor

SKU 344629
CPTRCP581V **2,249⁹⁹**

- Premium Model Includes: Low Oil Level Switch, Auto Tank Drain, Triple Pass Pump Mounted Aftercooler

Lift Gate Service

SKU 361260 **125⁰⁰**

7.5 HP Vertical Air Compressor

SKU 012624
CPTRCP-7581VS **2,099⁹⁹**

- CFM: 25.3 @ 100 PSI
- Volts: 208 - 230 Single Phase
- 175 Max PSI
- Premium Cast Iron and Aluminum Hybrid Pump
- Mag Starter Included
- Solid Cast Iron Cylinders
- High Performance Inter-Cooler and Aftercooler
- Comes Ready to Run, No Startup Kit Required



7.5 HP Two Stage Premium Air Compressor

SKU 344631
CPTRCP-7581V **2,349⁹⁹**

- Premium Model Includes: Low Oil Level Switch, Auto Tank Drain, Triple Pass Pump Mounted Aftercooler

120 Gallon - 2 Stage Compressors

10 HP Horizontal Air Compressor

SKU 210437
IRT2545E10V **2,944⁹⁹**
• CFM: 35 @ 175 PSI
• Volts: 230 Three Phase
• Cast Iron Pump
• Factory Mounted and Wired Motor Starter



Delivery Included

10 HP Premium Horizontal Air Compressor

SKU 040549
IRT2545E10-P **4,069⁹⁹**
• Features of the Non-Premium Model Plus Air-Cooled Aftercooler

Lift Gate Service

SKU 262532
IRTLIFTGATE **80⁰⁰**

- Electronic Automatic Tank Drain
- Low Oil Level Protection Switch

Startup Kit

SKU 970497 **174⁹⁹**
IRT32305898

- 4 Quarts Synthetic Lube and 2 Air Filters
- Use of Kit Extends Compressor Pump Warranty to 2 Years

In Stock - Ready to Ship

10HP 120 Gallon Three Phase 230V Air Compressor

SKU 592204
26104 **2,699⁹⁹**

- 35 CFM at 100 PSI, 175 PSI Max Pressure
- Heavy Duty, Low-RPM Cast Iron Pump
- Magnetic Starter Mounted and Wired
- Includes Oil and Filter - No Startup Kit Required
- ASME Tank and Safety Valves
- High Flow Belt Guard
- 2 Year Warranty on the Whole Machine

Lift Gate Service

SKU 295540 **80⁰⁰**



In Stock - Ready to Ship

BONUS VALUE **\$154.98**

Heavy Duty Composite Stubby Air Impact Wrench

SKU 087596 | 24418 **139⁹⁹**

PVC Air Hose - 3/8" x 50'

SKU 125076 **14⁹⁹**

Offer Good Through March 31, 2019 While Supplies Last

10 HP Horizontal Air Compressor

Chicago Pneumatic

SKU 012626
CPTC10123HS **2,749⁹⁹**

- CFM: 35 @ 100 PSI
- Volts: 208 - 230 Three Phase
- 175 Max PSI
- Premium 800 RPM Cast Iron Pump
- Mag Starter Included
- Concentric Disc Valves
- Cast Iron Inter-Cooler and Aftercooler
- Full 2 Year Warranty



10 HP Vertical Air Compressor

SKU 012634
CPTC10123VS **3,049⁹⁹**

Lift Gate Service

SKU 361260 **125⁰⁰**



• Free Delivery in 48 Continental United States • Specifications Subject to Change without Notice or Liability. Prices Do Not Include Vehicles, Installation or Optional Equipment as Shown. • Customers Responsible for Off-Loading Equipment Upon Arrival. Ask Your Sales Rep for Details. • Leasing Terms Available.† Ask Your AutoZone® Commercial Sales Manager.

FOR FINANCING PROGRAMS SEE PAGE 2

877-AZTool1
877-298-6651
 Hablamos Español
AZtool1.com



Call 877-AZTOOL1 (877-298-6651) or email us at aztool@aztool1.com for details, sizing and pricing.

Need More Air?

We Offer Chicago Pneumatic Duplex and Rotary Screw Compressors that Provide Up to 48 CFM on Single Phase Power and 64 CFM on Three Phase Power.

Need Drier Air?

Water is an Air Tool's Enemy. We Offer Affordable Dryers for All Applications.



Gas Compressors

5.5 HP, 30 Gallon Horizontal with Honda Engine

SKU 110298 OEMPUK5530G **999⁹⁹**
 • Gas Powered Honda Engine
 • CFM: 12 @ 90 PSI
 • ASME Certified

Lift Gate Service

SKU 295540 OEMLIFTGATE **80⁰⁰**

Carb Compliant

WARRANTY: 1 Year Parts



HONDA OEM TOOLS™

8 HP, 30 Gallon Horizontal with Honda Engine

SKU 979920 OEMTUE8030HGE **1,799⁹⁹**
 • Electric Start
 • CFM: 16 @ 175 PSI
 • Cast Iron Pump
 • Synthetic Oil

Lift Gate Service

SKU 295540 OEMLIFTGATE **80⁰⁰**

Carb Compliant

WARRANTY: 1 Year Parts



Duplex Compressor

10 HP 120 Gallon Two Stage Single Phase Horizontal Reciprocating Duplex Air Compressor

SKU OUTSIDE BUY/EPO CPTRCP-C10121D **3,849⁹⁹**

- Start/stop Dual Pressure Switch Control
- 1" Tank Discharge Valve
- Fully Enclosed Belt Guard
- ASME Safety Valves on Tank and Pump
- Full 2 year Warranty (Including Valves)

Lift Gate Service

SKU 361260 CPTLIFTGATE **125⁰⁰**

RCP Series Compressors Exceptional Strength

Available via Outside Buy/EPO, Call 1-877-298-6651 for Ordering Instructions



Single Stage Compressors

X Force Black Label Series XF-VT6389

SKU 081193 XFCXF-VT6389 **399⁹⁹**
 • 3.0 Peak Horse Power
 • 5.5 CFM @ 90 PSI
 • Assembled in U.S.A.
 • Factory Reconditioned with 1 Year Parts Warranty

Lift Gate Service

SKU 295540 OEMLIFTGATE **80⁰⁰**



X Force Black Label Series XF-VT6362

SKU 081197 XFCXF-VT6362 **449⁹⁹**
 • 6.0 Peak Horse Power
 • 11 CFM @ 90 PSI
 • Assembled in U.S.A.
 • Factory Reconditioned with 1 Year Parts Warranty

Lift Gate Service

SKU 295540 OEMLIFTGATE **80⁰⁰**



X Force Black Label Series XF-TQ3126

SKU 081199 XFCXF-TQ3126 **699⁹⁹**
 • 7.0 Peak Horse Power
 • 16 CFM @ 90 PSI
 • Assembled in U.S.A.
 • Factory Reconditioned with 1 Year Parts Warranty

Lift Gate Service

SKU 295540 OEMLIFTGATE **80⁰⁰**



Champion®

Advantage Series Model VR7F-8

SKU 305807 CHCADVA-S168 **3,179⁹⁹**
 • 7.5 HP
 • 80 Gallon Vertical Tank
 • 208V/1 Phase
 • One Piece Cylinder and Cylinder Head
 • High Efficiency Stainless Steel Disc Valves
 • Two Piece Connecting Rod

Lift Gate Service

SKU 295540 OEMLIFTGATE **80⁰⁰**



Regulators/Filters/Drains

Digital Air Regulator

SKU 978113 25862 **19⁹⁹** REG. \$29.99 **SAVE \$10**
 • Ensures Accurate and Consistent Air Pressure for Spray Guns and Other Air Operating Tools

Offer Good Through March 31, 2019 - While Supplies Last

Regulator with Gauge (1/4")

SKU 543086 ARRR262G **29⁹⁹**
 • Adjustment Range is 5 - 125 PSIG
 • Rated for 25 SCFM

Disposable In-Line Desiccant Filter Dryer (1/4")

SKU 543077 ARRDFD-10 **19⁹⁹**
 • Maximum Flow Capacity: 15 CFM
 • Maximum Pressure: 125 PSI
 • See-Through Housing Shows Desiccant Color Change, Indicates That the Dryer Needs to Be Replaced

Particulate Filter (1/2")

SKU 543079 ARRF354 **39⁹⁹**
 • 40 Micron
 • 100 CFM
 • 150 PSI

Particulate Filter (3/8")

SKU 543078 ARRF353 **39.99**

Air Regulator with Gauge (1/2")

SKU 543091 ARRR354G **49⁹⁹**
 • Adjustment Range is 5 - 125 PSIG
 • Rated for 100 SCFM

Regulator with Gauge (3/8")

SKU 543088 ARRR353G **54.99**

Automatic Lubricator (1/2")

SKU 543085 ARRL354 **59⁹⁹**
 • Lubricator May Be Filled without Shutting Down Air Line
 • 3 Position Adjustment Knob

Automatic Lubricator (3/8")

SKU 543083 ARRL353 **59.99**

1/2 Inch Electronic Drain

SKU 543065 ARR5804 **74⁹⁹**
 • Automatically Drains Compressor Tanks, Receiver Tanks or Filters
 • 110 Volt
 • 6' Power Cord

5 Stage Desiccant Filter/Dryer

SKU 543076 ARRC7612XL **375⁹⁹**
 • Includes Gauge, Shut-Off Valve and One Gallon of Desiccant
 • Lowers the Dew Point to -30° F

Replacement Desiccant Silica Gel, 1 Quart

SKU 543068	ARR34189	15.99
------------	----------	--------------

Filter Regulator Lubricator with Gauge Modular Combo (1/2")

SKU 543075 ARRC33354 **199⁹⁹**
Extend the Life of Your Air Tools!
 • Cleans, Dries and Lubricates Air Supply
 • Operating Pressure Range 5 - 125 PSI
 • 40 Micron Element
 • 142 CFM

Filter Regulator Lubricator w/ Gauge Modular Combo (1/4")

SKU 543072	ARRC33352	199.99
------------	-----------	---------------

Filter Regulator Lubricator w/ Gauge Modular Combo (3/8")

SKU 543073	ARRC33353	199.99
------------	-----------	---------------

Integral Filter/Regulator with Gauge (1/2")

SKU 543071 ARRB754G **74⁹⁹**
 • Operating Pressure Range 5 - 125 PSI
 • 40 Micron Element
 • 3 Position Non-Rising Adjustment Knob

Integral Filter/Regulator w/ Gauge (1/4")

SKU 543069	ARRB752G	69.99
------------	----------	--------------

Integral Filter/Regulator w/ Gauge (3/8")

SKU 543070	ARRB753G	69.99
------------	----------	--------------

Coalescing Filter Oil Removing Filter (1/2")

SKU 543081 ARRF554AW **74⁹⁹**
 • .03 Micron Filter Element
 • 37 CFM
 • Manual Drain

Coalescing Oil Removing Filter (3/8")

SKU 543080	ARRF553AW	74.99
------------	-----------	--------------

• Free Delivery in 48 Continental United States • Specifications Subject to Change without Notice or Liability. Prices Do Not Include Vehicles, Installation or Optional Equipment as Shown. • Customers Responsible for Off-Loading Equipment Upon Arrival. Ask Your Sales Rep for Details. • Leasing Terms Available.† Ask Your AutoZone® Commercial Sales Manager.

AIR TOOLS

DID YOU KNOW?

AutoZone® has availability to over 14,000 unique part numbers for replacement engines and transmissions.

Contact Your AutoZone Commercial Sales Manager for Details

3/8" Impact Wrenches

Mighty Compact 3/8" Drive Impact Wrench

SKU 802213
24411 **109⁹⁹** REG. \$119.99

- Lightweight and Compact, Weighs Only 3.5 Lbs.
- Fits in One Hand (5-1/4" in Length)
- Free Speed: 11,000 RPM
- Working Torque: 280 Ft/Lbs.
- Maximum Torque: 320 Ft/Lbs. Reverse
- Clutch Type: Twin Hammer

SAVE \$10

4.7 CFM



Offer Good Through March 31, 2019 - While Supplies Last

3/8" Titanium Impact Wrench

SKU 198065
IRT2115TIMAX **239⁹⁹**

- Torque: 300 Ft/Lbs.
- Feather Touch Trigger and Patented Push Button Forward/Reverse



3/8" Impact Wrench

SKU 970486
IRTIR212 **209⁹⁹**

- Most Powerful 3/8" Pistol Grip Impact
- Torque: 180 Ft/Lbs.
- Single Hammer Design



1/2" Impact Wrenches

Heavy Duty 1/2" Composite Stubby Impact Wrench

SKU 087596
24418 **139⁹⁹** REG. \$149.99

- 1/2" Square Composite Air Impact Delivering 900 Lbs. of Torque
- Includes (7) 1/2" Short Impact Sockets Sizes 13 mm-19 mm
- Custom Cut EVA Foam for Storage Tray

SAVE \$10

4.0 CFM



Offer Good Through March 31, 2019 While Supplies Last

Mighty Compact 1/2" Impact Wrench

SKU 626146
24403 **109⁹⁹** REG. \$149.99

- Max. Torque: 450 Ft/Lbs. Reverse
- 3 Torque Adjustments
- Small but Powerful
- Lightweight: 3.5 Lbs.

SAVE \$40

4.7 CFM



Offer Good Through March 31, 2019 While Supplies Last

1/2" Titanium Impact Wrench

SKU 695134
IRT2235TIMAX **344⁹⁹**

- 1,350 Ft/Lbs. of Torque
- 930 Ft/Lbs. of Reverse Torque
- Twin Hammer Impact Mechanism
- Lightweight



1,350 Ft/Lbs. of Nut Busting Torque

1/2" Impact Wrench Classic

SKU 495316
IRT231C **124⁹⁹**

- Torque: 600 Ft/Lbs.
- Pressure-Fed Lubrication
- Adjustable Power Regulator
- 1/2" Square Drive



Original Twin Hammer Impact

1/2" Super Air Impact Wrench with 2" Extended Anvil

SKU 604744
IRT231HA2 **199⁹⁹**

- In-Handle Exhaust Directs Air Away from User
- 590 Ft/Lbs. Maximum Torque
- Pressure-Fed Lubrication System



Best Selling Tire Impact

1/2" Composite Impact Wrench

SKU 347258
24400 **239⁹⁹**

- Max. Torque: 900 Ft/Lbs.
- Air Inlet Thread: 3/8"
- Weight: 4.58 Lbs.
- Sound Level: 96.2 dBA
- CFM: 5.1



BONUS VALUE: \$14.99

PVC Air Hose - 3/8" x 50'

SKU 125076 | 25837

With Purchase of:

1/2" Composite Impact Wrench

SKU 347258 | 24400

Offer Good Through March 31, 2019 - While Supplies Last

1/2" Composite Impact Wrench

SKU 900832
25775 **149⁹⁹**

- Max Torque: 500 Ft/Lbs.
- Soft-grip Handle
- Weight: 4.2 Lbs.



3.9 CFM

1/2" Impact Wrench

SKU 884521
25821 **59⁹⁹**

- Torque: 400 Ft/Lbs.
- 6,500 RPM Forward



5.6 CFM

1/2" Impact Wrench

SKU 900831
25774 **89⁹⁹**

- Torque: 400 Ft/Lbs.



5.6 CFM

1/2" Drive Air Mini Impact Wrench

SKU 744023
KNGNC-4620HQ **219⁹⁹**

- Jumbo Hammer Type Impact Wrench
- Compact Size and Lightweight at 3.7 lbs
- Industrial Grade Durability and Quality
- Avg. Air Consumption: 4.4 CFM
- Max Torque 500 FT-LB



4.4 CFM

1/2" Quiet Impact Wrench

SKU 738489
IRT2135QXPA **279⁹⁹**

- Torque: 780 Ft/Lbs.
- Light, Quiet and Powerful Impact
- Twin Hammer Mechanism
- Weighs Only 4 Lbs.



Super Quiet

1/2" Impact Wrench

SKU 970487
IRT231HA **159⁹⁹**

- Pressure-Fed Lubrication System
- Handle Exhaust Directs Air Away from User
- Industry Standard for 3 Decades
- Sound Pressure: 94 - 105 dBA



590 Ft/Lbs. of Torque

1/2" Thundergun Street Legal™ Impact Wrench

SKU 495318
IRT232TGSL **364⁹⁹**

- Torque: 625 Ft/Lbs.
- 10,000 RPM for Lightning Fast Removal is Best-in-Class



1/2" Drive Composite Impact Wrench

SKU 592243
KNGNC-4255Q **219⁹⁹**

- 1,200 Ft/Lbs. Max Reverse Torque
- 85 dBA Noise Level Bests OSHA Standards
- Ultra Lightweight at 3.74 Pounds
- Twin Hammer Mechanism



1/2" Drive Impact Wrench

SKU 592249
KNGNC-4232Q **189⁹⁹**

- 700 Ft/Lbs. Max Reverse Torque
- 85 dBA Noise Level Bests OSHA Standards
- Ultra Lightweight at Less Than 3 Pounds
- Twin Hammer Mechanism



Mighty Small, Mighty Powerful Air Impact Wrench

3/4" Impact Wrenches

3/4" Heavy Duty Impact Wrench

SKU 466617
25810 **279⁹⁹**

- Torque: 1,300 Ft/Lbs.
- 4,400 RPM Free Speed



6.6 CFM

3/4" Drive Composite Impact Wrench

SKU 592352
KNGNC-6255Q **279⁹⁹**

- One of the Lightest and Most Powerful 3/4" Drive Guns
- 1,400 Ft/Lbs. of Max Reverse Torque
- 85 dBA Noise Level Bests OSHA Standards
- Ultra-Light 4.2 Pounds
- Twin Hammer Mechanism



3/4" Drive Quiet Air Impact Wrench

SKU 592242
KNGNC-6236Q **289⁹⁹**

- Power of a 3/4" Drive in a 1/2" Body
- 1,200 Ft/Lbs. Max Reverse Torque
- 83 dBA Noise Level Bests OSHA Standards
- Weighs 5.9 Pounds
- Twin Hammer Mechanism



1" Impact Wrenches

1" Super Duty Impact Wrench with Extended Anvil

SKU 466618
25811 **379⁹⁹**

- Torque: 1,600 Ft/Lbs.
- 3,700 RPM Free Speed



9.0 CFM

Integrated Protective Cover

M7 Mighty Seven NC-8237 1" Drive Air Impact Wrench

SKU 592207
KNGNC-8237 **599⁹⁹**

- Super Light and Quiet for a 1" Gun
- 1,800 Ft/Lbs. of Max Reverse Torque
- 92 dBA Noise Level
- 12.8 Pound Weight
- Twin Hammer Mechanism



1" Impact Wrench with Extended Anvil

SKU 970474
IRTIR285B6 **694⁹⁹**

- 1,770 Ft/Lbs. of Reverse Torque
- 6" Anvil for Better Truck Wheel Nut Accessibility
- Hi-Efficiency Motor





FREE OVERNIGHT SHIPPING
WITH MOST ORDERS
SEE PAGE 3 FOR DETAILS

1/4" Air Ratchets

1/4" Drive Super Duty Air Impact Ratchet
SKU 850508 24415 **109⁹⁹** REG. \$119.99

- Max Torque: 50 Ft/Lbs.
- Free Speed: 700 RPM
- CFM: 3.1 @ 90 PSI
- Length: 6.5"
- Sealed Head Ratchet Housing Prolongs Tool Life
- Compact and Lightweight
- Most Power to Weight Ratio
- Rear Air Exhaust: 360° Adjustable

SAVE \$10

Impact Mechanism Adds Power and Prevents Kickback

Offer Good Through March 31, 2019 While Supplies Last

BONUS VALUE: \$9.99
BUY EITHER OF THESE, GET THIS

OEMTOOLS™ Recoil Air Hose - 1/4" x 50'
SKU 125157 | 25858

With Purchase of: **3/8" Drive Mini Super-Duty Air Impact Ratchet** OR **1/4" Drive Super Duty Air Impact Ratchet**

SKU 850055 | 24416 OR SKU 850508 | 24415

Offer Good Through March 31, 2019 - While Supplies Last

3/8" Drive Mini Super-Duty Air Impact Ratchet

SKU 850055 24416 **109⁹⁹** REG. \$119.99

- Max Torque: 50 Ft/Lbs.
- Free Speed: 700 RPM
- CFM: 3.1 @ 90 PSI

SAVE \$10

Impact Mechanism Adds Power and Prevents Kickback

Offer Good Through March 31, 2019 - While Supplies Last

Air Ratchets

1/4" Industrial Air Ratchet
SKU 466593 25763 **49⁹⁹**

- Delivers 18 Ft/Lbs. of Torque and 240 RPM Free Speed

1/4" Stubby

SKU 970472 1RT105D2 **134⁹⁹**

- Delivers 25 Ft/Lbs. of Torque and 250 RPM Free Speed

3/8" Drive Reactionless Air Ratchet

SKU 347259 24401 **99⁹⁹**

- Maximum Torque: 75 Ft/Lbs.
- Free Speed: 450 RPM
- Air Inlet: 1/4" NPT
- Air Consumption: 2.5 CFM
- Ratchet Pawl: Single
- Exhaust: Rear

Impact Mechanism Adds Power and Prevents Kickback

3/8" Air Ratchet

SKU 970485 1RT107XPA **134⁹⁹**

- Max Torque: 54 Ft/Lbs.
- Advanced Head Design
- 360° Adjustable Exhaust

3/8" Super-Duty Air Ratchet

SKU 495290 1RT109XPA **169⁹⁹**

- Torque: 76 Ft/Lbs.
- Variable Speed Button Trigger
- 360° Adjustable Exhaust

Cut-Off Tools

Heavy Duty Reciprocating Air Saw
SKU 802225 24409 **64⁹⁹**

- Recommended Air Pressure: 90 PSI
- Air Consumption: 1.7 CFM
- Enhanced Blade Guard Design and Trigger Safety Lock
- 9,000 Strokes per Minute

Air Reciprocating Saw

SKU 970481 1RT1R429 **124⁹⁹**

- Designed for Cutting Intricate Shapes
- Cuts Flat and Curved Surfaces
- Comes with 6 High Speed Steel Cutting Blades

Air Sanders and Polishers

2" Surface Prep Tool
SKU 094650 25778 **49⁹⁹**

All Twist Lock Accessories Work with This Sander

- RPM: 20,000
- CFM: 3
- 4 Position Air Volume Control
- Quick Change "Twist Lock" Mandrel

Straight Line Sander

SKU 970479 1RT1R315 **159⁹⁹**

- Twin Piston Design for Smooth Operation
- 3,000 Strokes per Minute
- Quick-Action Paper Clamps

6" Dual Action Sander

SKU 970475 1RT1R311A **84⁹⁹**

- Dual Action Pad Motion Reduces Swirl
- Built-in Silencer for Quiet Operation

High Speed Air Sander

SKU 466594 25764 **44⁹⁹**

- Air Consumption: 4.5 CFM
- Free Speed: 15,000 RPM
- Recommended Air Pressure: 90 PSI
- Sound Level: 88 dBA
- Weight: 2-1/2 Lbs.

2" and 3" Starter Pack Surface Prep Kit

SKU 812338 24944 **29⁹⁹**

- Includes: (3) 2 In. and (2) 3 In. Medium Grit Surface Prep Discs, (5) 2 In. and (3) 3 In. Coarse Surface Prep Discs, (3) 2 In. and (2) 3 In. Sander Discs
- Type "R" Button Backing Fits All Type "R" Holders (Holders Not Included)
- Guaranteed to Last as Long as the Competition

Heavy Duty Mini Surface Prep Kit

SKU 087620 24417 **99⁹⁹** REG. \$109.99

SAVE \$10

Includes:

- 2" and 3" Heavy Duty Mini Air Surface Prep Sander
- (1) 2" Backer Pad and (1) 3" Backer Pad
- (2) 2" and (2) 3" Medium Grit Surface Prep Discs
- (2) 2" and (2) 3" Coarse Surface Prep Discs
- (2) 2" and (2) 3" Sander Discs
- Air Nipple
- Wrench

Offer Good Through March 31, 2019 While Supplies Last

5" High Speed Air Sander

SKU 688297 80-365 **39⁹⁹**

- Free Speed: 18,000 RPM
- Designed for Light Sanding, Feathering, Edging and Rust Removal

Die Grinders

1/4" Mini Air Die Grinder
SKU 751631 24404 **34⁹⁹** REG. \$49.99

- Requires Only 2.4 CFM @ 90 PSI for Optimum Performance
- Free Speed: 25,000 RPM
- Ultra Compact Size Fits Into Spaces Regular Die Grinders Cannot
- Lightweight: 0.7 Lbs.
- Collet Size: 1/4"
- Includes: 1/4" Mini Die Grinder and 2 Wrenches

SAVE \$15

Offer Good Through March 31, 2019 While Supplies Last

1/4" Mini Angle Air Die Grinder

SKU 802214 24407 **54⁹⁹**

- Air Consumption: 2.8 CFM
- Free Speed: 18,000 RPM
- Recommended Air Pressure: 90 PSI
- Air Inlet Thread Size: 1/4" NPT
- Angle: 90 Degrees

1/4" Extended Air Die Grinder

SKU 802216 24408 **64⁹⁹** REG. \$79.99

- Air Consumption: 2.5 CFM
- Free Speed: 23,000 RPM
- Recommended Air Pressure: 90 PSI
- Air Inlet Thread Size: 1/4" NPT

SAVE \$15

Offer Good Through March 31, 2019 While Supplies Last

1/4" Mini Air Die Grinder

SKU 802211 24405 **39⁹⁹**

- Air Consumption: 3.4 CFM
- Free Speed: 25,000 RPM
- Recommended Air Pressure: 90 PSI
- Air Inlet Thread Size: 1/4" NPT
- Includes: 1/4" Compact Die Grinder and 2 Wrenches

1/4" Mini Die Grinder

SKU 802212 24406 **49⁹⁹**

- Air Consumption: 3.4 CFM
- Free Speed: 22,000 RPM
- Recommended Air Pressure: 90 PSI
- Air Inlet Thread Size: 1/4" NPT
- Includes: 1/4" Compact Die Grinder and 2 Wrenches

1/4" Mini Die Grinder

SKU 466591 25761 **44⁹⁹**

- Air Consumption: 4.0 CFM
- Free Speed: 26,000 RPM
- Recommended Air Pressure: 90 PSI
- Air Inlet Thread Size: 1/4" NPT
- Recommended Hose Size: 3/8"

1/4" Mini Angle Die Grinder

SKU 466592 25762 **79⁹⁹**

- Air Consumption: 6 CFM
- 25,000 RPM Free Speed
- Recommended Air Pressure: 90 PSI
- Air Inlet Thread Size: 1/4" NPT
- Recommended Hose Size: 3/8"

Air Hammers

Heavy Duty Air Hammer
SKU 900833 25776 **74⁹⁹** REG. \$79.99

- 3,500 BPM
- Recommended Air Pressure: 90 PSI
- Air Consumption: 6.3 CFM
- Air Inlet Thread Size: 1/4" NPT

SAVE \$5

Offer Good Through March 31, 2019 While Supplies Last

Reversible Drills

3/8" Reversible Air Drill
SKU 466595 25765 **69⁹⁹**

- 90 PSI
- 4 CFM Air Consumption
- 2,200 RPM Free Speed
- 35 In/Lbs. Max Torque
- Sound Level: 96 dBA
- Weight: 2-1/2 Lbs.

AIR TOOL ACCESSORIES



42 Piece 3/8" Impact Socket Set in EVA Foam Tray

- SKU 087600 **99⁹⁹**
23983
- (8) 3/8" Drive 6-Point SAE Sockets, Sizes 5/16"-3/4"
 - (12) 3/8" Drive 6-Point Metric Sockets, Sizes 8 mm-19 mm
 - (8) 3/8" Drive Deep 6-Point SAE Sockets, Sizes 5/16"-3/4"
 - (12) 3/8" Drive Deep 6-Point Metric Sockets, Sizes 8 mm-19 mm
 - 3/8" Drive 3" Extension Bar
 - 3/8" Drive Universal Joint

OEM TOOLS™



EVA
FOAM TRAY

Impact Sockets

3/8" Impact Sockets

- 6 Point High Quality Impact Sockets
- SAE: 5/16", 3/8", 7/16", 1/2", 9/16", 5/8", 11/16", 3/4", 13/16", 7/8", 15/16" and 1"
- Metric: 8, 9, 10, 11, 12, 13, 14, 15, 16, 17, 18 and 19 mm

12 Pc. Shallow (SAE)

SKU 391191
25589 **26⁹⁹**



12 Pc. Shallow (Metric)

SKU 391190
25587 **21⁹⁹**

1/2" Impact Sockets

- 6 Point High Quality Impact Sockets
- SAE: 3/8", 7/16", 1/2", 9/16", 5/8", 11/16", 3/4", 13/16", 7/8", 15/16" and 1"
- Metric: 10, 11, 12, 13, 14, 15, 16, 17, 18 and 19 mm

11 Pc. Shallow (SAE)

SKU 391195
25593 **29⁹⁹**



10 Pc. Shallow (Metric)

SKU 391192
25591 **26⁹⁹**

12 Pc. Deep (SAE)

SKU 442193
25590 **39⁹⁹**



12 Pc. Deep (Metric)

SKU 464314
25588 **34⁹⁹**

11 Pc. Deep (SAE)

SKU 391196
25594 **54⁹⁹**



10 Pc. Deep (Metric)

SKU 391194
25592 **44⁹⁹**

33 MM, 1" Drive "Budd" Style Wheel Socket

SKU 466569
25528 **29⁹⁹**

- 1" Drive 33 mm Budd Wheel Socket for Mack, Midliner, Volvo, White and Other Import Trucks with Dual Rear Wheels



35 MM, 1" Drive "Budd" Style Wheel Socket

SKU 466566
25525 **19⁹⁹**
REG. \$25.99

- 1" Drive 35 mm Budd Wheel Socket for Mack, Midliner, Volvo, White and Other Import Trucks with Dual Rear Wheels



SAVE
\$6

Offer Good Through March 31, 2019
While Supplies Last

1-1/2" Hex x 13/16" Square Deep 1" Drive "Budd" Style Wheel Socket

SKU 466570
25529 **29⁹⁹**

- For Budd Wheel 1-1/2" Hex with 13/16" Inside Square



Cut-Off Accessories

Mandrel for 1/4" and 3/8" Screws (2 Pack)

SKU 094907
SHA32 **24⁹⁹**



3" x 1/16" x 3/8" Cut-Off Wheels for Cutting Aluminum, 10pk

SKU 306331
SHA13178PK2 **19⁹⁹**

- Silicon Carbide Grain
- Works on All 3" Die Grinders



3" x 1/16" x 3/8" Cut-Off Wheel, 25PK

SKU 306273
SHA25E5PK5 **29⁹⁹**

- Use with Any Pneumatic Cut-Off Tools
- Never Exceed the Recommended RPM
- Maximum 25,000 RPM



Couplers/ Plugs

High Flow Coupler and Plug Kits

OEM TOOLS™

- Ideal for HVLP Spray Guns and High Torque Impact Wrenches
- Delivers the Highest Air Volume with the Lowest Pressure Drop

7 Pc., 1/4" Body, 1/4" NPT

SKU 757040 | 26132 **19⁹⁹**



14 Pc. 1/4" Body, 1/4" NPT

SKU 757091 | 26134 **29⁹⁹**



7 Pc., 1/4" Body, 3/8" NPT

SKU 757046 | 26133 **19⁹⁹**



MILTON INDUSTRIES, INC.

Hi-Flo V-Style 1/4" MNPT Steel Plug, 10 Pk. SKU 480772 . MILS7601-5 . **24⁹⁹**

Hi-Flo V-Style 3/8" MNPT Steel Plug, 10 Pk. SKU 480775 . MILS7621-5 . **29⁹⁹**

Hi-Flo A,M,V-Style 1/4" FNPT Coupler, 2 Pk. SKU 480783 . MILS764-2 . **24⁹⁹**

Hi-Flo A,M,V-Style 3/8" FNPT Coupler, 2 Pk. SKU 480784 . MILS766-2 . **24⁹⁹**

Improves Performance of High Air Consumption Air Tools.

1/2" Female Coupler G-Style, Ea SKU 481703 . MILS1815 **19⁹⁹**

1/2" Male Coupler G-Style, Ea SKU 481696 . MILS1816 **19⁹⁹**

1/2" Male Plug G-Style, 5 Pk SKU 480770 . MILS1817-5 . . . **24⁹⁹**

1/2" Female Plug G-Style, 5 Pk SKU 480771 . MILS1818-5 . . **27⁹⁹**

OEM TOOLS™

1/4" Universal, No Scratch, Composite Body Quick Coupler

SKU 099186
24241 **14⁹⁹**

- 1/2" x 18 NPT; Female



Fits All 3
ARO Trufflate Industrial

1/4" Universal Composite Body Quick Coupler (5 Pack)

SKU 297201
24241PK **39⁹⁹**

- Quick One-Handed Connection Will Save You Time
- 1/2" x 18 NPT; Female
- One Size Fits Most



1/4" Air Swivel Connectors

SKU 099162
24242 **19⁹⁹**

- 360° Swivel Action at 2 Points for Maximum Maneuverability
- 1/4" NPT
- Maximum Air Pressure: 150 PSI



OEM TOOLS™

Surface Prep

OEM TOOLS™

2" Surface Prep Discs (25 Pack) Twist-Lock Style

Coarse
SKU 125687
24941 **34⁹⁹**
1.40 each

Medium
SKU 125690
24940 **34⁹⁹**
1.40 each



3" Surface Prep Discs (25 Pack) Twist-Lock Style

Coarse
SKU 125691
24942 **44⁹⁹**
1.80 each

Medium
SKU 125692
24943 **44⁹⁹**
1.80 each



2" Purple Strip Disc with Rollock, 5 Pack

SKU 298097
SHA16206 **19⁹⁹**



2" Surface Disc Assortment Twist-Lock Style

SKU 094920
SHA620TBA **44⁹⁹**

- Includes: (12) Coarse, (10) Medium, (3) Fine and (1) 2" Holder



Twist-Lock Disc Holders

SKU 094911
SHA323T2 **29⁹⁹**
• 2" Holder / 2 Pack

SKU 094916
SHA333T2 **29⁹⁹**
• 3" Holder / 2 Pack

SKU 094912
SHA323TB **29⁹⁹**
• 2" and 3" Holder Set

Thermostat Gasket Residue Remover

SKU 291346
LIS22500 **25⁹⁹**

- Floating Guide Shaft to Steer Abrasive Pad Around the Gasket Surface
- Use with a Die Grinder to Quickly Clean Off the Gasket Surface



Twist-Lock Mini Grinding Discs



GREEN ZIRCONIA					
ITEM	SKU	SIZE	GRIT	Qty	PRICE
SHA12613	306282	2"	36	25	\$29.99
SHA12614	305896	2"	50	25	\$29.99
SHA12615	204022	2"	80	25	\$29.99
SHA12617	306323	3"	36	25	\$34.99
SHA12618	305827	3"	50	25	\$34.99
SHA12619	204009	3"	80	25	\$34.99
SHA13083	306277	2"	ASSORTED	6	\$37.99



RED CERAMIC					
ITEM	SKU	SIZE	GRIT	Qty	PRICE
SHA12622	306325	2"	36	25	\$33.99
SHA12624	202403	2"	50	25	\$33.99
SHA12626	203670	2"	80	25	\$33.99
SHA12628	305938	3"	36	25	\$38.99
SHA12630	305940	3"	50	25	\$38.99
SHA12632	202357	3"	80	25	\$38.99
SHA13086	202436	2"	ASSORTED	6	\$24.99

2" Mini Flap Discs Assorted Grits, 6 Pk

SKU 306275
SHA13056 **29⁹⁹**

- Outlasts Mini Grinding Discs By 3 Times
- Includes 2 Each of 40, 60 and 80 Grit



Impact Adapters

OEM TOOLS™

5 Piece Adapter and Universal Joint Set (3/8" and 1/2" Drive)

SKU 965864
24226 **29⁹⁹**

- Chrome Moly Steel Construction
- Includes: 3/8" Drive Universal Joint, 3/8" Drive (F) x 1/2" (M) Adapter, 1/2" Drive Universal Joint, 1/2" Drive (F) x 3/8" (M) Adapter and 1/2" Drive (F) x 3/4" (M) Adapter



Impact Star

OEM TOOLS™

10 Piece External Star Socket Set

SKU 191054
25954 **19⁹⁹**

- Includes: 3/8" - 1/2" Drive Star: E5, E6, E7, E8, E10, E12, E14, E16, E18 and E20
- Chrome Moly Steel Construction



Impact Extensions

OEM TOOLS™

1/2" to 3/8" Drive Reducing Extension Adapters

SKU 110292
25240 **59⁹⁹**



AIR HOSES AND REELS

877-AZTool1
877-298-6651
 Hablamos Español
AZtool1.com

HEAVY DUTY POLYMER - NEVER KINKS!

VIPERFLEX®

3/8" x 50 Ft. Hybrid Polymer Air Hose

SKU 347224
 24424 **109⁹⁹**

- Heavy Duty Polymer Hose Material Redefines Flexibility - Stays Flexible Under All Weather Conditions (-40° to 150° F)
- Holds No Memory - Kink Resistant Under Pressure
- 300 PSI Working Pressure
- Bend Restriction for Reducing Wear and Tear and Extending Life of Hose
- Solid Brass MNPT Ends



Hose Included

Whip Hoses

1/4" NPT End Fittings

3/8" x 4 Ft. Swivel Whip Hose

SKU 347219
 24420 **15⁹⁹**



3/8" NPT End Fittings

1/2" x 4 Ft. Swivel Whip Hose

SKU 347221
 24421 **21⁹⁹**



3/8" Hoses

1/4" NPT End Fittings

3/8" x 25 Ft. Air Hose

SKU 347222
 24422 **22⁹⁹**



3/8" x 100 Ft. Air Hose

SKU 347225
 24425 **60⁹⁹**

SKU 347223
 24423 **25⁹⁹**

3/8" x 50 Ft. Air Hose

SKU 347223
 24423 **25⁹⁹**



1/2" Hoses

1/2" NPT End Fittings

1/2" x 25 Ft. Air Hose

SKU 347226
 24426 **24⁹⁹**



1/2" x 50 Ft. Air Hose

SKU 347227
 24427 **48⁹⁹**

1/2" x 100 Ft. Air Hose

SKU 347228
 24428 **74⁹⁹**

Hoses and Hose Reels

3/8" x 50 Ft. Air Hose Reel

SKU 900815
 25979 **109⁹⁹**

- Smooth Automatic Retracting Spring Coil
- 50 Ft. Hose
- 3/8" NPT Fittings
- Max. Pressure: 250 PSI



OEM TOOLS™

3/8" x 50 Ft. Value Series Air Hose Reel

SKU 972284
 LIN83753 **189⁹⁹**

1/2" x 50 Ft. Value Series Air Hose Reel

SKU 972285
 LIN83754 **209⁹⁹**

- Retractable Delivery Hose
- Durable Heavy Gauge Steel Construction
- Slotted Mounting Base for Easy Installation



LINCOLN

3/8" x 25 Ft. Red Rubber Air Hose, 1/4" NPT Male Ends

SKU 978117
 24905 **29⁹⁹**

- Working Pressure: 250 PSI

3/8" x 50 Ft. Red Rubber Air Hose, 1/4" NPT Male Ends

SKU 978112
 24906 **34⁹⁹**

- Working Pressure: 250 PSI

1/2" x 50 Ft. Red Rubber Air Hose, 1/2" NPT Male Ends

SKU 978116
 24908 **59⁹⁹**

- Working Pressure: 250 PSI



GOODYEAR
 ENGINEERED PRODUCTS

3/8" x 5 Ft. x 1/4" NPT Swivel End Whip Hose

SKU 186489
 IRTWH385 **24⁹⁹**

- 1-1/4" x 1/4" NPT Ends
- Working Pressure: 200 PSI
- Burst Pressure: 800 PSI
- OSHA Yellow for Safe Visibility
- Temperature Range: -20 to 150 Degrees



IR Ingersoll Rand

100 Ft. Manual Steel Hose Reel

SKU 291343
 25970 **22⁹⁹** REG. \$32.99

- Hand Crank with Spring-Loaded Axle
- Mount Horizontally or Vertically



OEM TOOLS™

SAVE \$10

Offer Good Through March 31, 2019 - While Supplies Last

Piping Systems

RapidAir Compressed Air Piping System 1/2" Master Kit

SKU 360485
 RAP90500 **139⁹⁹**

- Designed to Easily Install Beneath Walls of New Construction or on Wall Surfaces of Existing Workshops
- Allows Compressed Air Lines Exactly Where You Want Them, Just Like Electrical Outlets
- Includes: 2 Air Outlet Kits, 1 Compressor Manifold Kit, 100' Nylon Tubing and Tubing Cutter



1/2" RapidAir Outlet Kit

SKU 360542
 RAP90100 **32⁹⁹**

Compressor Manifold Kit

SKU 360548
 RAP90200 **34⁹⁹**

100 Ft. RapidAir Tubing Kit

SKU 360549
 RAP20100 **49⁹⁹**

MaxLine Compressed Air Piping System 3/4" Master Kit

SKU 360593
 RAPM7500 **249⁹⁹**

- Heavier Duty Components for Longer Air Runs in Larger Buildings
- 3 Air Outlets, (1) 3/4" NPT Straight Fitting, 2 Tees, 20 Clips
- 100' of 3/4" HDPE Tubing



RAPIDAIR
 Compressed Air Piping System

3/4" MaxLine Outlet Kit

SKU 360629
 RAPM7510 **29⁹⁹**

Aluminum Core: Holds Any Bent Shape!

100 Ft. 3/4" MaxLine Tubing Kit

SKU 360649
 RAPM6030 **139⁹⁹**

300 Ft. 3/4" MaxLine Tubing Kit

SKU 360650
 RAPM6031 **369⁹⁹**

3/4" Union Fitting

SKU 360656
 RAPM8022 **19⁹⁹**



Inflators

OEM TOOLS™

Dual-Head Chuck Tire Inflator Gauge

SKU 094652
 25864 **24⁹⁹** REG. \$29.99

SAVE \$5

- 6" Chrome-Plated Dual-Head Chuck with Full 360° Swivel Action and 15" Air Hose
- Capacity: 10 to 120 PSI
- Gauge Reads in 2 Lb. Increments



Offer Good Through March 31, 2019 - While Supplies Last

Tire Inflator

OEM TOOLS™

SKU 301772
 24380 **61⁹⁹**

- Clear and Easy-to-Read 80 mm 180 PSI Gauge
- 3-in-1 Function: Inflate, Deflate and Measure Tire Pressure
- Increased Accuracy to Improve Tire Performance and Prevent TPMS Comebacks



Digital Tire Inflator

OEM TOOLS™

SKU 802198
 24412 **64⁹⁹**

- Easy-to-Read Backlit LCD Display
- Four Units of Measure (PSI, Bar, kPa, kgf)
- Measuring Range: 0 - 175 PSI (0 - 12 Bar)
- Accuracy: +/-1.2 PSI Up to 58 PSI, +/-2.3 Between 58 PSI and 145 PSI Inclusive, +/-3.6 PSI Greater Than 145 PSI
- High Air Flow Saves the Technician Time

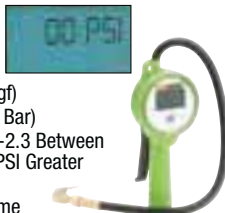

Inflator Gauge, Dual-Head Straight Foot for Inner Duals

MILTON INDUSTRIES INC.

SKU 301603
 MILS516 **62⁹⁹**

- 15" Hose
- 10 - 120 PSI Dual Foot Straight Chuck Ideal for Dual Wheel Equipped Vehicles
- Heavy Duty Construction Provides for Long Life Even Under Extreme Use and Conditions
- Gauge and Valve Cartridges are Replaceable
- Equipped with Magnifying Lens for Full View of Scale



Air Chucks

OEM TOOLS™

Air Chuck with Comfort Grip Handle

SKU 802200
 24414 **17⁹⁹**

- Durable, OEM Screwdriver Style Handle for Comfort and a Positive Grip
- Sealed-Ball Air Chuck is Extended 1" from Handle to Allow Access to Tight Areas



Dual Foot Air Chuck with Comfort Grip Handle

SKU 802201
 24413 **19⁹⁹**

- Comfortable Screwdriver Style Handle
- 30° Reverse Angle Chuck Can Be Used on Outside Tires
- Tilt Lock Feature Locks onto the Valve

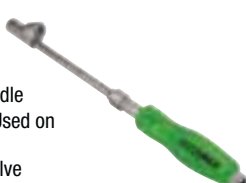

Air Blow Gun

OEM TOOLS™

5 Piece Interchangeable Tip Air Blow Gun

SKU 338823
 24439 **19⁹⁹**

- Includes 4 Interchangeable Tips: 100 mm (4"), 140 mm (5.5"), 320 mm (12.5") and a Turbo Wide Angle Nozzle
- Quick Change Coupling Makes it Easy to Change Tips
- Wide Angle Nozzle for High Volume
- Variable Trigger to Control Volume and Tip Pressure
- 1/4" NPT Air Inlet

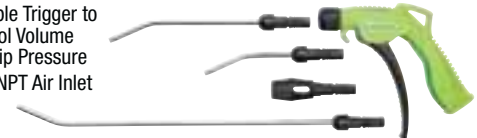

AIR TOOLS & ACCESSORIES

AVAILABLE FOR HOT SHOT DELIVERY*

VAPER

4-in-1 Interchangeable Blow Gun Kit

SKU 285972
19475 **19⁹⁹**



QUICK RELEASE ROTATING KNOB



WIDE ANGLE FAN TIP



VENTURI TIP BOOSTS AIR FLOW
4X



ALSO INCLUDES: 13 INCH AND 4-1/4 INCH RUBBER TIP NOZZLES



STORE STOCKED

AIR TOOLS

1/2" Drive Air Impact Wrench

SKU 976504
19748
• 230 Ft/Lbs. Maximum Torque
STYLES MAY VARY



44⁹⁹

Air Hammer

SKU 976508
19750



22⁹⁹

STYLES MAY VARY

Air Die Grinder

SKU 977046
19747
• Ideal for Light Duty Metal Fabrication, Grinding, Porting and Polishing Applications



STYLES MAY VARY

3" Air Cut-Off Tool

SKU 976505
19746
• 18,000 RPM No Load Speed
STYLES MAY VARY



31⁹⁹

Dual Setup Spray Gun Kit

SKU 976507
19766
79⁹⁹
• 1.4 mm Set for Lighter Materials
• 1.7 mm Set for Heavier Materials
• Locking Pressure Regulator with Gauge
• Operating Pressure: 15 - 45 PSI



Siphon Feed Spray Gun

SKU 976511
19418
• 1.8 mm Needle



44⁹⁹

1.4 mm Gravity Feed HVLP Spray Gun

SKU 976510
19765
• Stainless Steel Needle and Nozzle Set



44⁹⁹

3/8" Drive Air Ratchet

SKU 976509
19749
• 45 Ft/Lbs. Max Torque
STYLES MAY VARY



STORE STOCKED

AIR ACCESSORIES

Pistol Style Blow Gun

SKU 977886
19360
• OSHA Compliant Tip



4⁹⁹

Blow Gun with Removable Venturi Tip

SKU 807628
19402
• Venturi Tip Allows for 4X the Air Flow!



9⁹⁹

Blow Gun with Rubber Tip

SKU 976307
19435
1/4" (6.3 mm) NPT (F)



5⁴⁹

Dual Foot Inflator and Gauge

SKU 977878
19341 **12⁹⁹**



Tire Inflator and Gauge

SKU 977879
19344
• 0 to 150 psi



14⁹⁹

Digital Tire Inflator

SKU 543041
19357
• Easy to read backlit LCD display
• Inflation range: 0-174 psi



74⁹⁹

Air Adjusting Valve with Gauge

SKU 978090
19359
• 0 to 140 PSI



6²⁹

(2) 3/8" Hose Splicers

SKU 977888
19345 **2³⁹**



Quick Connect Set

SKU 977885
19330
• 1/4" NPT Female & Male



4²⁹

Air Adjusting Valve with Gauge

SKU 977895
19303
• 1/4" NPT



13⁵⁹

(2) 3/8" Hose Ends

SKU 980359
19346 **2⁶⁹**



17 Piece Accessory Kit

SKU 977877
19338



12⁹⁹

Spot Sprayer

SKU 333347
19419
• Designed to Spray Fluids Such As Alcohol, Solvents and Cleaners



32⁹⁹

STORE STOCKED

AIR HOSES

Hybrid Air Hose

THE AIR HOSE YOU WON'T FIGHT

3/8" x 25'

SKU 268697
19464

3/8" x 50'

SKU 977898
19465

19⁹⁹

21⁹⁹



KINK RESISTANT



ULTRA FLEXIBLE

50' Rubber Air Hose

SKU 359693
19382 **29⁹⁹**
• Working Pressure: 300 PSI
• Burst Pressure: 1,200 PSI



50' PVC Air Hose

SKU 977899
19371 **18⁹⁹**
• Working Pressure: 300 PSI
• Burst Pressure: 1,200 PSI



1/4" x 25' Recoil Hose

SKU 977897
19368

9⁹⁹



STORE STOCKED



REVOLUTIONARY LUMENATION

Multi-Application Work Lights Deliver Functionality of Several Lights in Just One Versatile Light



200 Lumens

SKU 105545
24603 **34⁹⁹**
 • 3 Hr. Run Time on High
 • Length: 6"

600 Lumens

SKU 822266
25997 **59⁹⁹**
 • 6 Hr. Run Time on High
 • Length: 13.4"

330 Lumens

SKU 105560
24605 **39⁹⁹**
 • 4 Hr. Run Time on High
 • Length: 8.5"

1000 Lumens

SKU 850228
24604 **129⁹⁹**
 • 9 Hr. Run Time on High
 • Length: 23.6"



LIGHT ACCESSORY KIT

SKU 435496
24608 **14⁹⁹**

Rubber End Casings

- Non-Marring End Casings
- Use with Magnetic Adhesive Pads on Non-Ferrous Surfaces
- 2 Pack

Magnetic Adhesive Pads

- Ideal for Non-Ferrous Metal Surfaces

Hanging and Pivoting Hooks

- Pivots 180°
- 2 Pack

Hanging Strap

- Nylon Strap
- Adjustable Lengths



For undercar and suspension work, the magnetic attachment can attach to any ferrous surface.



Utilize the pistol grip attachment to use as a spot light, or to inspect tight spaces.

Compact Illumination 1,000 Lumens Where You Need It

Hood Hawk Rechargeable Underhood Light Set

SKU 064925
EZRXLUHL **99⁹⁹**

The E-Z RED XLUHL Hood Hawk Li-Ion Underhood Light Set is a multi-functional shop light that provides 1,000 lumens of wide-angle lighting to illuminate your entire workspace. The revolutionary attachment system provides three innovative options to adapt to the job at hand.

DIAGNOSTIC WORK LIGHT THE MOST INNOVATIVE 3-IN-1

SKU 591153
24609 **99⁹⁹**
 • 5 Hr. Run Time on High
 • Length: 13.4"

13.4" Multi-Use
Rechargeable Diagnostic
Under-the-Hood Work Light

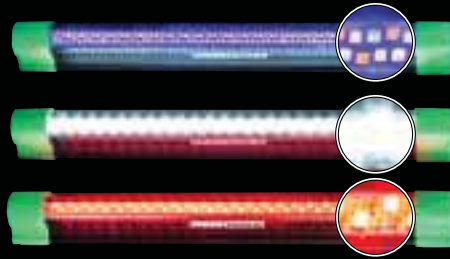

UV Leak Dye
Detection Light

400 LUMENS Super
Bright Work Light

Yellow Smoke
Detection Light



Charge Devices
with Universal
USB Port

Digital Charge
Level Indicator



Work Lights



16.25" Tire Kicker and High Performance Bat Light (Black)

SKU 432100 **24⁹⁹**

SKU 467251 **24⁹⁹**

SKU 32818 (Black)

SKU 32820 (Gray)

3 Beam Settings

High Low Flashing

(4) AA

MAX RUN TIME 72hrs

200 LUMENS

32818

32820

Enduro® LED Headlamp

SKU 291379 **27⁹⁹**

STL61400

• Uses (2) 1.5V AAA Batteries

100 LUMENS

MAX RUN TIME 1hr



Handheld Fluorescent Lights

- Heavy Duty End Caps with Shatterproof Casing
- 360° Rotating Hook
- 15' Cord

26 Watt
SKU 915801 | 25984 **49⁹⁹**



7 LED Rechargeable Work Light

SKU 819644 **49⁹⁹**

25982

- 3W COB LED, Super Bright White Lights: 210 Lumens
- 3.7V 2200 mAh Li-ion Battery
- Run Time: 3 Hrs. (Work Light), 20 Hrs. (Torch Light)

210 LUMENS

MAX RUN TIME 3hrs



Swivels, Hang, or Stick



- Cordless, Rechargeable
- Powerful Magnets on the Back and Swivel Base
- Recharge Using USB Cable (Included)

Bounce Lite® Reel and Light

SKU 186477 **144⁹⁹**

CEN12010

- Patented Bounce-Bulb Shock Technology Protects Bulb When Light is Dropped
- 40' Oil and Water Resistant 18/2 Gauge SJTOW 110 Volt Power Cord
- Heavy Duty Swivel Hook and Fully Enclosed Safety Switch

SKU 186476 **114⁹⁹**

SKU 186475 **119⁹⁹**

• 25' Oil and Water Resistant 18/2 Gauge SJTOW 110 Volt Power Cord

Bounce Lite® Bulbs

SKU 186480 **24⁹⁹**

SKU 1100617

• Replacement Bulbs for CEN12009 and CEN12010



25 Watt Underhood Lite® and LitePerch®

SKU 186479 **179⁹⁹**

CEN13003

- Hands-Free Lighting of Entire Engine Compartment
- Works on All Passenger Cars and Light Trucks
- 25' 18/2 Heavy Duty Power Cord
- LitePerch Opens: 4' to 6.6'



3 Pack Underhood Light® Bulbs

SKU 186481 **79⁹⁹**

SKU 1056026



LIGHTING

DID YOU KNOW?

AutoZone® carries over 30 part numbers of Power Sport Batteries. These fit motorcycles, ATVs/UTVs, snowmobiles and personal watercraft.

Contact Your AutoZone Commercial Sales Manager for Details

Great Deals On Rechargeable Flashlights

Super-Bright Rechargeable LED Palm Light

- SKU 912333 32859 **39⁹⁹**
- Compact and Lightweight at Only 2.9" Long and .07 Lbs. (Excluding Battery)
 - 100 Meter Beam Distance
 - Waterproof: IPX7
 - Magnetic Base
 - Includes Lanyard and Rechargeable RCR123A Battery

Fits in Your Palm



450 LUMENS
MAX RUN TIME **1.5hrs**

GreatLite

Periscope LED Flashlight

- SKU 526504 25458 **14⁹⁹**
- Beam Distance: 2m
 - Impact Resistance: 1.5m
 - Water Resistant: IPX-3
 - Comes with (2) AA Batteries



60 LUMENS
MAX RUN TIME **6hrs**

OEM TOOLS™

CREE LED Pen Light

- SKU 592184 32835 (Black) **NOW \$14⁹⁹ WAS \$19⁹⁹**
- Comes with (2) AAA Panasonic® Batteries and Tactical Clip
 - 3 Modes: Low (50 Lumens), High (150 Lumens) and Strobe
 - Battery Run Time: 6 Hours (Low), 3 Hours (High)
 - 80 Meter Beam Distance
 - Impact and Water Resistant
 - Dimensions: 5.7" (L) x 0.6" (D)
 - Weight: 1.6 Oz.



- Additional Colors
- (Blue) SKU 592185 32836
 - (Green) SKU 592186 32837
 - (Red) SKU 592188 32838
 - (Silver) SKU 592183 32839

150 LUMENS
MAX RUN TIME **3hrs**

GreatLite

E67 CREE LED Tactical Flashlight Kit

- SKU 462478 EXPE67-E02 **49⁹⁹**
- Beam Distance: 200m
 - Impact Resistance: 1.5m
 - Waterproof: IPX-8
 - Comes with (1) 18650 Battery and Charger



400 LUMENS
MAX RUN TIME **3hrs**

GreatLite

E84 CREE LED Professional Stubby Pocket Flashlight

- SKU 568464 EXPE84 **NOW \$19⁹⁹ WAS \$34⁹⁹**
- Dimensions: 3.5" (L) x 0.9" (D) x 0.9" (Head)
 - Beam Distance: 30m
 - Impact Resistance: 1.5m
 - Waterproof: IPX-8
 - Comes with (1) CR123A Battery



200 LUMENS
MAX RUN TIME **1.5hrs**

GreatLite

E66 CREE LED Flashlight

- SKU 347204 EXPE66 **NOW \$29⁹⁹ WAS \$49⁹⁹**
- Dimensions: 10.2" (L) x 1.7" (D) x 2.2" (Head)
 - Beam Distance: 300m
 - Impact Resistance: 1.5m
 - Water Resistant: IPX-4
 - Comes with (2) D Duracell® Batteries



500 LUMENS
MAX RUN TIME **3hrs**

GreatLite

E67 CREE LED Tactical Flashlight Only

- SKU 347205 EXPE67 **24⁹⁹** (Comes with (2) CR123A Batteries. Rechargeable Batteries and Charger Sold Separately)

E81 CREE LED Tactical Flashlight Kit

- SKU 462479 EXPE81-E02 **59⁹⁹**
- Beam Distance: 200m
 - Impact Resistance: 1.5m
 - Waterproof: IPX-8
 - Comes with (1) 18650 Battery and Charger



500 LUMENS
MAX RUN TIME **3hrs**

GreatLite

E81 Cree LED Tactical Flashlight Only

- SKU 347207 EXPE81 **NOW \$29⁹⁹ WAS \$49⁹⁹** (Rechargeable Batteries and Charger Sold Separately)

E54 Cree LED Tactical Flashlight Kit

- SKU 462477 EXPE54-E01 **79⁹⁹**
- Beam Distance: 300m
 - Impact Resistance: 1.5m
 - Waterproof: IPX-8
 - Comes with (2) 18650 Batteries and Charger



700 LUMENS
MAX RUN TIME **3hrs**

GreatLite

E87 Rechargeable Flashlight

- SKU 568466 EXPE87-E02 **49⁹⁹**
- Adjusts to 5 Light Modes: 500LM, 190LM, 35LM, STROBE and S.O.S.
- Beam Distance: 200m
 - Impact Resistance: 1.5m
 - Waterproof: IPX-8
 - Comes with (1) 18650 Battery and Charger



500 LUMENS
MAX RUN TIME **2hrs**

GreatLite

E36 CREE Rechargeable Flashlight Only

- SKU 568460 EXPE36 **NOW \$39⁹⁹ WAS \$44⁹⁹**
- Beam Distance: 300m
 - Impact Resistant Up to 1.5m
 - IPX-6 Water Resistant
 - Comes with (2) CR123A Batteries

800 LUMENS
MAX RUN TIME **2hrs**

(Rechargeable Batteries and Charger Sold Separately)



GreatLite

Strion® Rechargeable LED Flashlight with AC/DC Charger

- SKU 295851 STL74301 Black **179⁹⁹**
- Ultra-Compact and Powerful
 - C4® LED Technology
 - Impervious to Shock, 50,000 Hour Lifetime
 - Light Output: High (260 Lumens); Medium (130 Lumens); Low (65 Lumens)



E36 CREE Rechargeable Flashlight Kit

- SKU 568461 EXPE36-E02 **49⁹⁹** **Our Brightest Light!**
- Beam Distance: 300m
 - Impact Resistance: 1.5m
 - Water Resistant: IPX-6
 - Comes with (1) 18650 Battery and Charger

800 LUMENS
MAX RUN TIME **2hrs**



GreatLite

Stinger® Rechargeable LED Flashlight with AC/DC Piggyback Charger

- SKU 291368 STL75732 Black **199⁹⁹**
- C4® LED Technology
 - 3 Watt Super High Flux LED, Impervious to Shock with a 20,000 Hour Lifetime
 - Run Time: High (1.75 Hours); Medium (3.5 Hours); Low or Strobe (6.75 Hours)
 - Light Output: High (350 Lumens); Medium (175 Lumens); Low (85 Lumens)



Rechargeable Batteries

- Battery Charger for 32859**
SKU 912351 32860 **14⁹⁹**



- RCR123A Battery**
SKU 912338 32861 **17⁹⁹**
For Use with: 32859



- 3.7 Volt Li-ion Battery**
SKU 535222 EXPE04 **NOW \$9⁹⁹ WAS \$17⁹⁹**
For Use with: 32827, 24607, 24648



- 3.7 Volt 18650 Rechargeable Battery**
SKU 347210 EXPE03 **17⁹⁹**
For Use with: Explorer Series



- Charging Unit for (1) 18650 Battery**
SKU 347209 EXPE02 **24⁹⁹**
• Comes with (1) 18650 Battery



GreatLite



FREE OVERNIGHT SHIPPING
WITH MOST ORDERS
SEE PAGE 3 FOR DETAILS

Work Lights

Slim Folding Rechargeable Work Light

SKU 081750 26028 **39⁹⁹**

- COB Super Bright Work Light – 350 Lumens
- Max Output: 350 Lumens/175 Lumens
- Function: Low-High-OFF
- Run Time: 2 Hrs. (350 Lumens), 4 Hrs. (175 Lumens)
- Head Swivels 180° and Adjustable 360°
- Beam Distance: 85 Ft.
- Powerful Magnetic Base
- Water Proof: IPX4
- Charge Time: 4 Hrs.
- Lightweight: 0.5 Lbs. (Including Battery)

NEW



Adjustable Illumination at any Angle



Powerful Magnetic Base Puts Light Where You Need It



2-in-1 Rechargeable Pocket Light

SKU 081751 26029 **29⁹⁹**

- 2-in-1 Pocket Light: Super Bright COB LED Work Light with Integrated LED Flashlight
- Convenient Pocket Clip Rotates 120° for Adjustable Illumination
- Easy Hands-Free Operation with Magnetic Base and Magnetic Pocket Clip
- Max Output (Work Light): 200 Lumens

OEM TOOLS™

NEW

- Max Output (Flashlight): 140 Lumens
- Run Time: 3 Hrs.
- Charge Time: 3 Hrs.
- Lightweight: 0.25 Lbs.
- Cordless and Rechargeable (50 cm USB Cable Included)



120° Rotating Magnetic Clip

Inspection Light

700 Lumen Rechargeable COB LED Slim Inspection Light

SKU 418752 24646 **29⁹⁹**

- Unique Variable Dial Lets You Control Output (0-700 Lumens)
- Run Time: 10 Hours (at 50% power), 2.5 Hours (at 100%)
- Removable Magnetic Base with 360° Swivel and Lock Feature Lets You Adjust Angle to Point Light Where it's Needed

OEM TOOLS™

Dimming Light Dial

SHOP SUPPLY of the MONTH
JANUARY
SEE INSERT FOR DETAILS



USB Charging Port

360° Swivel Base



Rechargeable Multi-Head All-in-One Work Light Kit

OEM TOOLS™

SKU 765525 24648 **99⁹⁹**

- Quick-Attachment Allows for Easy Accessory Transition

One Flashlight Body + Handle with Multiple Attachments

1 Powerful Flashlight Attachment Produces 350 Lumens



AAA AAA

2 Dual Function Inspection Light Attachment Produces 350 Lumens and Features a UV Setting

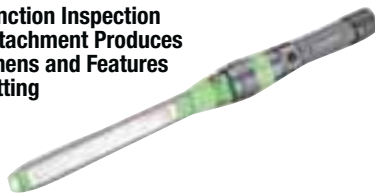

3 15" Flexible Extension Attachment Illuminates Hard-to-Reach Areas and Features a Focusing Lens



Comes With (1) 18650 Rechargeable Lithium-ion Battery

Accessories Included: USB Charging Cord, Adapter, and 360° Swivel Hook



2 Powerful Magnets on the Swivel Hook Stick to Any Ferrous Surface



Work Lamp Attachment for 24648 Work Light Kit

SKU 884377 24648E **19⁹⁹**

- Adds Versatility to the 24648 Multi-Head Work Light Set

Pro 500 Lumen Rechargeable Flashlight with 450 Lumen Ultra Slim Inspection Light

SKU 798710 32827 **59⁹⁹**

- Beam Distance: Flashlight 170m, Inspection 30m
- Impact Resistance: 1m
- 5 Light Modes: 100%, 50%, 25%, Strobe and S.O.S.
- Includes USB Charging Cord with UL Adapter and (1) 18650 Rechargeable Battery



USB Rechargeable

One Flashlight Body with Interchangeable Heads



500 LUMENS FLASHLIGHT

450 LUMENS INSPECTION

MAX RUN TIME 3.5hrs

GreatLite®

Attachable 360° Hook for 32827 Light

SKU OUTSIDE BUY/EPO 32829 **9⁹⁹**

Rotates 360°



Available via Outside Buy/EPO, Call 1-877-298-6651 for Ordering Instructions

Mechanic's 500 Lumen Rechargeable Flashlight and 450 Lumen Ultra Slim Wand with UV Inspection

SKU 344835 24607 **79⁹⁹**

- Five Light Modes: 100%, 50%, 25%, Strobe and S.O.S.
- Flashlight Head Can Be Removed and Replaced with the Slim Inspection Light (as Shown)
- 3 Powerful, UV LED Lights on Inspection Light Detect Leaks Quickly and Easily

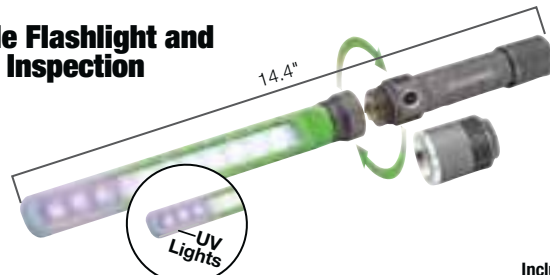

UV Lights

Detachable 180° Swivel Hook

USB Rechargeable

500 LUMENS FLASHLIGHT

450 LUMENS INSPECTION

MAX RUN TIME 3.5hrs

Includes Hook Battery

OEM TOOLS™

Pivoting Ultra-Slim Work Light

SKU 603727 24696 **29⁹⁹**

- Ultra-Slim Body Design Pivots 180° Providing More Light to Any Work Area
- Magnetic Base Attaches to Any Ferrous Surface
- 4 Light Modes: High, Low, Top Light and Handle Spotlight
- Handle Spotlight Offers an Additional Light Function
- Top Light Illuminates the Tightest Work Areas
- 3 AAA Batteries Included

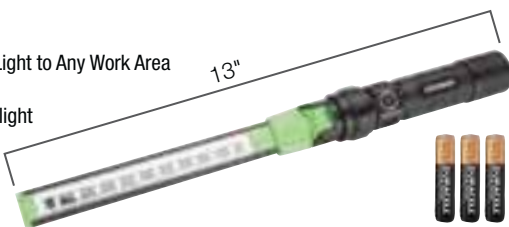

13"

(3) AAA

Rotates 180°

Top Light

Handle Spotlight

300 LUMENS FLASHLIGHT

MAX RUN TIME 1.5hrs

OEM TOOLS™

STORE STOCKED

LIGHTING

EIKO[®] LIGHTING

Commercial Stocking, Cabinet & New Tray Program

Conveniently stores and displays popular automotive miniature lamps

Cabinet has individual bins that offer easy product selection and inventory at-a-glance

Tray has a durable and long lasting case which guarantees a long term attractive display



Lamps Included With Tray:

1156 (10)	168 (10)	2057 (10)	7440 (10)
1157 (10)	194 (10)	3057 (10)	7443 (10)
1157NA (10)	194NA (10)	3157 (10)	921 (10)

With slots for the following optional mini bulbs:

37	211-2	1895	7506	4114K
57	906	2825	7528	4157K
67	912	6418	3047K	4157NAK
74	1003	7225	3157NA	DE3175

Cabinet Includes:



AutoZone Commercial Tray

SKU 800038, Part# AZTRAY - \$89.99

AutoZone EIKO Commercial Cabinet

SKU 312725, Part# AZCABINET- \$129.99

With over 135 items in-stock & over 200 items available for order, we have all your lighting needs covered. Ask your AutoZone sales contact for additional information on this program.



ECCO[®]

PROFESSIONAL SAFETY PROVIDER FOR COMMERCIAL VEHICLES

**BACK-UP ALARMS | BEACONS
CAMERA SYSTEMS | DIRECTIONAL LEDS
INTERIOR LIGHTING | LIGHTBARS | MINIBARS
SAFETY DIRECTORS | UTILITY BARS | WORKLAMPS**



SKU127365 / SKU203956
7945A / 7945A-VM
SAE CLASS II LED
Medium & Heavy Duty
109⁹⁹ / 129⁹⁹



SKU126984 / SKU126927
5580CA / 5580CA-VM
SAE CLASS II LED
High-Intensity Illumination
324⁹⁹ / 354⁹⁹



SKU210363 / SKU210378
EW2461-NA / EW2461-CAMO
Magnetic LED
Rechargeable battery
104⁹⁹ / 104⁹⁹



SKU127458 / SKU127345
E92004 / E29007
700 Lumens
3 Year Warranty
69⁹⁹ / 64⁹⁹

DID YOU KNOW?

AutoZone® carries Weather-Tech brand of floor mats and other Weather-Tech accessories.

Contact Your AutoZone Commercial Sales Manager for Details

877-AZTool1
877-298-6651
 Hablamos Español
AZtool1.com



NEW



SKU **949391** SL26RU
 SKU **082956** SL26BU
 SKU **949392** SL26GU

Mini Lithium Ion Cordless LED Work Lights

- UNIQUE BALL JOIN ENABLES 360° SWIVEL AND TILT
- 5 Super-Bright SMD LEDs
- Soft-touch rubberized casing
- Multifunction button for work light and torch
- End-mounted super-strong magnet
- USB/Micro USB charging cable
- Swivel hook
- Rechargeable lithium ion battery
- 1 watt torch function

59⁹⁹



360° LED Cordless Work Light + Magnetic Torch

SKU **082952** SL158U **64⁹⁹**

- UNIQUE BALL JOIN ENABLES 360° SWIVEL AND TILT
- 7 super-bright SMD LEDs
- 3 watt torch function
- Multifunction button for high/low and torch function
- Two rear and end-mounted super-strong magnets
- 120 AC wall charger with USB/Micro USB charging cable
- Swivel hook
- Rechargeable lithium ion battery
- High-impact ABS housing



SKU **949397** SL360RU
 SKU **949398** SL360BU
 SKU **949397** SL360GU

Lithium Ion 360° LED Cordless Work Lights

- LITHIUM ION 360° CORDLESS WORK LIGHT AND MAGNETIC TORCH
- Two swivel hooks and three covered magnets allow hands-free operation
- 10 Super-bright SMD LEDs
- High-powered 3W directional torch
- Multifunction switch for high/low and torch function
- Charging port for included 120V AC and 12V chargers
- Unique ball joint enables 360° swivel and tilt
- Rechargeable lithium ion battery

89⁹⁹



SKU **949402** SL137R
 SKU **949403** SL137B
 SKU **594727** SL137G

360° Plus Cordless Lithium Ion LED Work Light

- CORDLESS RECHARGEABLE WORK LIGHT AND MAGNETIC TORCH
- WITH TWO 2600 mAh LITHIUM ION BATTERIES
- Two rechargeable lithium ion batteries for longer operation
- 16 Super-bright SMD LEDs
- High-powered 3W directional torch
- Soft touch rubberized casing
- Unique ball joint enables 360° swivel and tilt
- Two swivel hooks and three covered magnets allow hands-free operation
- Multifunction switch for high/low and torch function
- Battery level LED indicators
- Charging port for AC and car chargers (not included)

109⁹⁹

NEW



SKU **083828** SL184RU
 SKU **083825** SL184BU
 SKU **083827** SL184GU

Lithium Ion 360° Slim Rechargeable Work Light

These 600 lumen lamps are ideal for daily use at home or in the shop. The unique ball joint allows the full range, swivel and tilt to aim the dimmable light where you need it. The magnetic base or folding hook can hold it in place leaving both hands free to work. Keeping the lithium ion battery charged will ensure you have 90 working minutes of bright light on hand.

- Unique ball joint enables 360° swivel and tilt
- 16 super-bright SMD LEDs
- 1W torch – 120 lumens
- Rotary dimmer switch – adjusts from 50 to 600 lumens
- 2600 mAh rechargeable lithium ion battery
- 5-LED charging status indicator
- Strong magnetic base with a folding hook
- IP54 and IK07 rated

65⁹⁹

NEW



360° SMD LED Portable Rechargeable Work Light

SKU **082953** SL175RU **164⁹⁹**

- IDEAL FOR ELECTRICIANS, CONTRACTORS & DIYERS
- 72 super-bright SMD LEDs
- 4400 mAh rechargeable lithium ion battery
- Up to 3,000 lumens
- High, medium, low settings
- 6500K
- CRI rating 80+
- IP65 rated
- Aluminum housing with steel stand and foam-covered handle
- Flexible 360° swivel and tilt – position in any direction
- 3-LED charging status indicator
- 5V, 2.1A USB output – charges mobile devices



15W COB LED Under-the-Hood Work Light

SKU **949407** SL176RU **149⁹⁹**

- 3 ADJUSTABLE LAMPS PROVIDE UP TO 400 LUMENS EACH
- Lamp heads rotate, to allow flexible spread of light
- Each 5W COM LED lamp provides up to 400 lumens, to illuminate the whole work area
- 360-minute life (three lamps); 840-minute life (single lamp)
- Four 2600mAh rechargeable Lithium Ion batteries, for longer life
- Battery status LED indicators
- Die-cast aluminum housing with durable ABS
- Foam-covered handles
- COB covered with PC lens – for eye protection
- Micro USB charging socket, with charging cable

NEW



Lithium Rechargeable Flex Light With Magnetic Base

SKU **083835** SL876U **47⁹⁹**

- IDEAL FOR ELECTRICIANS, CONTRACTORS & DIYERS
- Cree® XPG High-Performance LED
- Max output: 250 lumens (high) 125 lumens (low)
- 2 modes: High and Low
- Beam distance: 100 meters
- Magnetic base
- Impact and water resistant (IPX4)
- Focus system: Spot Light/Wide Area
- Rechargeable Lithium Ion Battery: 18650 Li-ion
- Power On Indicator on Front
- LED Charging Level Indicator: Red—Charging/Green—Charged

Cree® is a registered trademark of Cree, Inc.



15-LED Rechargeable Magnetic Work Light

SKU **082954** SL197U **69⁹⁹**

The SL197U is perfect for lighting up your tool boxes, cabinets and work stations. The sliding magnetic brackets rotate 180° allowing a flexible spread of light to illuminate your whole work area with the 15 SMD LEDs. The battery status LED indicators let you know when it's time to charge the 2200mAh battery with the included charging cable via the micro USB charging socket. This light feature has durable aluminum housing with a PC lens to protect your eyes.

- Attaches to any ferrous metal surface
- Sliding magnetic brackets rotate 180°
- 15 SMD LEDs, 6500K, 80+ CRI
- Rechargeable lithium ion battery – 3.7V, 2.2Ah
- Durable aluminum housing
- Battery status LED indicator
- Micro USB charging socket, with charging cable

POWER TOOLS

OEM TOOLS™

20V MAX*
Li-Ion
TECHNOLOGY

POWER AND PERFORMANCE AT THE RIGHT PRICE

RECHARGEABLE PROFESSIONAL SERIES

ALL THE TOOLS YOU NEED - 1 BATTERY PLATFORM

20V MAX* Li-ion Heavy Duty 1/2" Drive Impact Wrench

SKU 818594
24481 **159⁹⁹**

- Speed: 0-2,200 RPM and 0-2,900 IPM
- Nut Busting Torque: 300 Ft/Lbs.
- Tightening Torque: 260 Ft/Lbs.
- Battery: 4.0Ah Li-ion
- Weight: 8 Lbs.
- 4 Battery Light Indicators: 100% (4), 75% (3), 50% (2) and 25% (1)
- Charge Time: 2 Hours
- Includes Li-ion Battery with Charging Station



20V MAX* Li-ion 1/2" Brushless Impact Wrench

SKU 592251
24486 **169⁹⁹**

- Anvil: 1/2" Square Drive
- Variable Speed: 0-2,600 RPM; 0-3,000 IPM
- Nut Busting Torque: 300 Ft/Lbs.
- Tightening Torque: 260 Ft/Lbs.
- Battery: 4.0Ah Li-ion
- Charge Time: 2 Hours
- Weight: 9.28 Lbs.
- Includes: 20V MAX* Li-ion Brushless 1/2" Drive Impact Wrench, Rechargeable 4.0Ah Li-ion Slide Battery and Charging Station



20V MAX* Li-ion 1/4" Brushless Impact Driver

SKU 592213
24487 **139⁹⁹**

- Drive: 1/4" Quick Release
- Variable Speed: 0-3,000 RPM; 0-3,000 IPM
- Nut Busting Torque: 300 Ft/Lbs.
- Tightening Torque: 260 Ft/Lbs.
- Battery: 2.0Ah Li-ion
- Charge Time: 1 Hour
- Weight: 7.17 Lbs.
- Includes: 20V MAX* Li-ion Brushless 1/4" Drive Impact Driver, Rechargeable 2.0Ah Li-ion Slide Battery and Charging Station



20V MAX* Li-ion Heavy Duty 1/2" 2 Speed Cordless Drill

SKU 818593
24482 **124⁹⁹**

- Chuck Size: 1/2"
- 2 Speed Gear Box: 0-600 RPM and 0-2,000 RPM
- 4 Battery Light Indicators: 100% (4), 75% (3), 50% (2) and 25% (1)
- Electric Brake
- Clutch: 21 + 1 Torque Clutch Setting
- LED Work Light
- Charge Time: 1 Hour
- Includes Li-ion Battery with Charging Station



20V MAX* Li-ion 1/2" Brushless Drill

SKU 592256
24484 **129⁹⁹**

- Chuck Size: 1/2" Keyless Jacob's Chuck
- Variable Speed: 0-600 RPM and 0-2,000 RPM
- Max. Torque: 310 In/Lbs.
- Electric Brake
- Clutch: 21 + 1 Torque Setting
- Battery: 2.0Ah Li-ion
- Charge Time: 1 Hour
- Weight: 7.63 Lbs.
- Includes: 20V MAX* Li-ion 1/2" Brushless Drill, Rechargeable 2.0Ah Li-ion Slide Battery and Charging Station



20V MAX* Li-ion 1/2" Brushless Hammer Drill

SKU 593469
24485 **139⁹⁹**

- Chuck Size: 1/2" Keyless Jacob's Chuck
- Variable Speed: 0-600 RPM and 0-2,000 RPM
- Max. Torque: 310 In/Lbs.
- Electric Brake
- Clutch: 21 + 1 Torque Setting
- Battery: 2.0Ah Li-ion
- Charge Time: 1 Hour
- Weight: 7.65 Lbs.
- Includes: 20V MAX* Li-ion 1/2" Brushless Hammer Drill, Rechargeable 2.0Ah Li-ion Slide Battery and Charging Station



20V MAX* Li-ion Reciprocating Saw

SKU 592353
24491 **99⁹⁹**

- Variable Speed: 0-3,000 SPM
- Length of Stroke: 1"
- Max. Cutting Capacity (Wood with 12" Blade): 3-1/8"
- Max. Cutting Capacity (Pipe): 3/4"
- Overall Length: 14-1/4"
- Battery: 2.0Ah Li-ion
- Charge Time: 1 Hour
- Weight: 7.29 Lbs.
- Includes: 20V MAX* Li-ion Reciprocating Saw, (1) High-Quality, Multi-Purpose Bi-Metal Reciprocating Saw Blade, Rechargeable 2.0Ah Li-ion Slide Battery and Charging Station



20V MAX* Li-ion Cordless Angle Grinder

SKU 598786
24492 **134⁹⁹**

- Speed: 0-10,000 RPM
- Max. Disc Diameter: 4-1/2"
- Spindle Thread: 5/8"
- Spindle Lock: Yes
- Battery: 4.0Ah Li-ion
- Charge Time: 2 Hours
- Weight: 7.97 Lbs.
- Includes: 20V MAX* Li-ion Cordless Angle Grinder, (1) Grinding Disc, (1) Assist Handle, Rechargeable 4.0Ah Li-ion Battery and Charging Station



20V MAX* Li-ion 6-1/2" Circular Saw

SKU 592349
24488 **139⁹⁹**

- No-Load Speed: 3,800 RPM
- Arbor Size: 5/8"
- Depth of Cut at 45 Degrees: 1-9/16"
- Depth of Cut at 90 Degrees: 2-1/8"
- Battery: 4.0Ah Li-ion
- Charge Time: 2 Hours
- Weight: 10.35 Lbs.
- Includes: 20V MAX* Li-ion Circular Saw, 6-1/2" Blade, Edge Guide, Rechargeable 4.0Ah Li-ion Slide Battery and Charging Station



20V MAX* Li-ion Jig Saw

SKU 592269
24489 **99⁹⁹**

- Variable Speed: 0-2,500 SPM
- Bevel Capacity: 45 Degrees
- Orbital Positions: 3
- Stroke Length: 3/4"
- Battery: 2.0Ah Li-ion
- Charge Time: 1 Hour
- Weight: 6.39 Lbs.
- Includes: 20V MAX* Li-ion Jig Saw, (1) High-Quality Blade for Wood, Rechargeable 2.0Ah Li-ion Slide Battery and Charging Station



ALL PROFESSIONAL TOOLS WORK WITH:



20V MAX* Li-ion
Replacement Battery 4.0Ah
SKU 824772
27314A **79⁹⁹**



20V MAX* Li-ion
Fast Battery Charger
SKU 824773
27314B **29⁹⁹**
• Charges Both 2.0Ah and 4.0Ah Batteries



20V MAX* Li-ion
Replacement Battery 2.0Ah
SKU 824777
27333A **49⁹⁹**

OEM TOOLS™

NOW AVAILABLE IN STORES

**20V MAX* Li-ion
 3/8" Drive Cordless
 Impact Wrench**

- SKU **52379** **69⁹⁹**
24661
- 3/8 In. Drive Ball Detent, Heat-Treated Anvil
 - Variable Speed: 0-2,400 RPM and 0-2,900 IPM
 - Max. Torque: 200 Ft/Lbs. (Forward) and 240 Ft/Lbs. (Reverse)
 - Battery: 1.5Ah Li-ion
 - Electric Brake
 - Battery Charge and Capacity Indicator Lights
 - Charge Time: 1 Hour
 - Contents: (1) 3/8 In. Cordless Impact Wrench, (1) 1.5Ah Lithium-ion Slide Battery and (1) Diagnostic Fast Battery Charger



**20V MAX* Li-ion
 3/8" Drive Cordless Drill**

- SKU **52383** **54⁹⁹**
24660
- No-Load Variable 2 Speed Gear Box: 0-350 RPM and 0-1,150 RPM
 - Max. Torque: 250 Ft/Lbs.
 - Max. Drilling Capacity: 5/16" (Metal) and 3/4" (Wood)
 - Keyless, Auto Spindle Lock Chuck Size: 3/8"
 - Clutch: 16 + 1 Torque Clutch Setting
 - Electric Brake
 - Forward and Reverse Switch
 - Battery Charge and Capacity Indicator Lights
 - Charge Time: 4-6 Hours
 - Contents: (1) 3/8" Cordless Drill/Driver, (1) 1.5Ah Lithium-ion Slide Battery and (1) Battery Charger



**Individual Battery and
 Charger Available**

- 20V MAX* Li-ion
Battery
 SKU **029415** **39⁹⁹**
24660A
- Fits 24660, 24661
 - Charges in 30 Minutes
- 20V MAX* Li-ion
Battery Charger
 SKU **029418** **29⁹⁹**
24660B
- Charges 24660A Batteries



STORE STOCKED

**20V MAX* Li-ion
 1/2" Drive Cordless Impact Wrench**

- SKU **52380** **99⁹⁹**
24670
- 1/2: Drive Ball Detent, Heat-Treated Anvil
 - Variable Speed: 0-2,200 RPM and 0-2,900 IPM
 - Max. Torque: 240 Ft/Lbs. (Forward) and 300 Ft/Lbs. (Reverse)
 - Battery: 2.0Ah Li-ion
 - Electric Brake
 - Forward and Reverse Switch
 - Battery Charge and Capacity Indicator Lights
 - Charge Time: 1 Hour
 - Contents: (1) 1/2 In. Cordless Impact Wrench, (1) 2.0Ah Lithium-ion Slide Battery and (1) Diagnostic Fast Battery Charger



STORE STOCKED

**Heavy Duty 1/2" Drive
 Impact Wrench**

- SKU **52388** **79⁹⁹**
24666
- Input Power: 8.5 Amp
 - Motor: 120V, 60Hz
 - 1/2" Square Drive with Hog Ring Retainer
 - No-Load Speed: 0-2,200 RPM and 0-3,000 IPM
 - Max. Tightening Torque: 320 Ft/Lbs.
 - Max. Nut Busting Torque: 400 Ft/Lbs.
 - Replaceable Carbon Brushes
 - 8 Ft. Cord



4V MAX Li-ion
 Cordless Screwdriver**

- SKU **339037** **24⁹⁹**
24667
- 1/4" Hex Drive with Auto Lock
 - No-Load Speed: 230 RPM
 - Trigger Activated LED Work Light
 - Toggle Switch for Easy Forward / Reverse Change
 - Battery Charge Indicator Lights on Tool
 - Contents: (1) 4V Cordless Screwdriver, (4) 1/4" Hex Bits and (1) Charger



STORE STOCKED

STORE STOCKED

**20V MAX* Li-ion
 Battery**

- SKU **OUTSIDE BUY/EPO** **59⁹⁹**
24662A
- Fits 24662
 - Charges in 30 Minutes



**20V MAX* Li-ion
 Battery Charger**

- SKU **OUTSIDE BUY/EPO** **39⁹⁹**
24662B
- Charges 24662A Batteries



Available via Outside Buy/EPO, Call 1-877-298-6651 for Ordering Instructions

STORE STOCKED

Dual Temp Heat Gun

- SKU **52387** **34⁹⁹**
24665
- Input Power: 10 Amp
 - Motor: 120V, 60Hz
 - Temperature Settings: 482° F / 842° F
 - Trigger: 3 Position Rocker
 - Hanging Loop for Storage
 - 6 Ft. Cord



**Rotary Tool with 35 Piece
 Accessory Kit**

- SKU **339082** **24⁹⁹**
24664
- Input Power: 1.2 Amp
 - Voltage: 120V, 60Hz
 - No-Load Speed: 10,000 - 35,000 RPM
 - Collet Capacity: 1/8" to 3/32"
 - Spindle Lock for Easy Bit and Accessory Change
 - 6 Ft. Cord
 - Includes Grinding Stones, Wheels, Brush, Sanding Bands and Disks, plus Grinding Cloth, and Cut Off Wheels



STORE STOCKED

4-1/2" Compact Angle Grinder

- SKU **52382** **29⁹⁹**
24663
- Motor: 6 Amp
 - Voltage: 120V, 60Hz
 - Speed: 10,500 RPM
 - Interchangeable Handle for Left or Right Hand Use
 - Heavy Duty, Cast Aluminum Gear Head for Strength and Durability
 - 6 Ft. Cord
 - Contents: (1) 4-1/2" Compact Angle Grinder, (1) Grinding Wheel, (1) Spanner Wrench and (1) Disc Guard



STORE STOCKED

3/8" Drill

- SKU **52385** **29⁹⁹**
24669
- Input Power: 4.0 Amp
 - Voltage: 120V, 60Hz
 - No-Load Speed: 0-3,000 RPM
 - 3/8" Keyless Chuck
 - Lock-On Button to Reduce User Fatigue
 - Belt Hanger for Convenience and Safety
 - 6 Ft. Cord



**Flexible Shaft Rotary
 Tool Extension**

- SKU **003483** **12⁹⁹**
24657
- Easily Attaches to Many Popular Rotary Tools



STORE STOCKED

MORE FROM OEMTOOLS™ POWER TOOLS

6" Bench Grinder with Lamp

- SKU **412598** **69⁹⁹**
80058
- Solid, Heavy Duty Construction for Shaping and Sharpening Hardened Steel
 - 6" Wheels with Tool Rests
 - Tool Rests Adjust to 45° or 90° Position
 - Includes: Coarse and Fine 6" Grinder Wheels, Goose Neck Lamp, Adjustable Eye Guards and Spark Breakers



Mounting Hardware Not Included

**Bench Grinder
 Stand**

- SKU **818596** **49⁹⁹**
80173
- Works with Most Bench Grinders
 - Base: 18-7/8" x 19-3/4"
 - Convenient 12-1/2" x 13-3/8" Tool Tray



Engraver

- SKU **339060** **24⁹⁹**
33624668
- Motor: 0.2 Amp
 - Voltage: 120V, 60Hz
 - Max. Continuous Operating Time: 5 Minutes
 - Replaceable, Tungsten Carbide Engraving Steel Tip Bit
 - Max. Depth Adjustment Dial: 9 Positions
 - Weight: 0.8 Lbs.
 - 6 Ft. Cord



7" Variable Speed Polisher

- SKU **592258** **79⁹⁹**
24496
- No-Load Speed: 1,000 - 3,000 RPM
 - Power: 11 Amp
 - Spindle Thread: 5/8"
 - Spindle Lock: Yes
 - Power Cord Length: 6 Ft.
 - Weight: 8 Lbs.
 - Includes: 7" Variable Speed Polisher (1) Sanding Paper (1) Sanding Pad (1) Terry Bonnet (1) Wool Bonnet (1) Foam Piece and 6 Ft. Power Cord



14" Chop Saw

- SKU **592253** **149⁹⁹**
24497
- Power: 15 Amp
 - No-Load Speed: 3,700 RPM
 - Disc Diameter: 14"
 - Clamping Vise: Yes
 - Arbor: 1"
 - Max. Cutting Depth: 4.72" Round Pipe
 - Power Cord Length: 6 Ft.
 - Weight: 33 Lbs.
 - Includes: 14" Chop Saw, 8 mm Hex Wrench, Cutting Blade and 6 Ft. Power Cord



Dual Temp Heat Gun

- SKU **592200** **39⁹⁹**
24498
- Powerful 1500 Watts Heating Power
 - 3 Position Trigger Switch for On/Off and Temperature Setting
 - Temperature: 482° F to 842° F (250° C to 450° C)
 - Built-in Aluminum Stand
 - 10 Piece Set Includes: Dual Temp Heat Gun, Nozzle Deflectors, 3 Interchangeable Scraper Blades, Scraper Handle, Scraper and Blow Mold Case



Oscillating Tool

- SKU **592331** **52⁹⁹**
24495
- Variable Speed: 11,000 - 20,000 OPM
 - Power: 2.3 Amp
 - Oscillating Angle: 3.2 Degrees
 - Overall Length: 14-1/2"
 - Power Cord Length: 6 Ft.
 - Weight: 4.1 Lbs.
 - Includes: Quick Release Oscillating Tool, (1) 3-1/2" Semi-Circle Wood Saw Blade, (1) 2" Rigid Scraper, (1) 1-1/4" Wood Plunge Blade, (1) Standard Sanding Pad, (3) 60/80/120 Grit Sandpapers and 6 Ft. Power Cord



POWER TOOLS



Makita
World's Largest
18V Li-ion
Tool Platform

3 YEAR WARRANTY
ON TOOL & BATTERY

12V Cordless Combo Kit

SKU 847089
MAKCT226 **134⁹⁹**

- 3/8" Driver Drill with 210 In/Lbs. of Max Torque
- 1/4" Impact Driver with 970 In/Lbs. of Max Torque
- Includes (2) 12V Slide Batteries
- Batteries Charge in 25 Minutes
- Built-in LED Light



18V LXT[®] Li-ion Sub-Compact Brushless Cordless 3/8" Impact Wrench Kit (2.0Ah)

SKU 949560
MAKXWT12RB **329⁹⁹**

- Compact Design Measures 5-5/8" Long
- Variable Speed: 0-1,300/0-2,400 RPM; 0-2,000/0-3,600 IPM
- BL[™] Brushless Motor Delivers 130 Ft/Lbs. of Max Torque



7" Variable Electric Polisher and Sander Kit - Corded

SKU 555414
MAK9237CX2 **309⁹⁹**

- 0 - 3000 RPM Variable Speed
- Constant Speed Control Maintains Speed Under Load
- Soft Start Feature for Easy Startups
- Externally Accessible Brushes for Easy Serviceability
- Includes a Foam Pad and Heavy Duty Tote Bag and (2) Bonnets



BONUS

GET ITEM BELOW
\$54.99 VALUE!
12V max CXT[™] Li-ion Compact Job Site Radio

SKU 434581
MAKRM02

VDP ORDERS ONLY



Offer Good Through March 31, 2019 - While Supplies Last

BONUS

GET ITEM BELOW
\$79.99 VALUE!
18V Lithium-ion 2.0Ah Battery

SKU 555436
MAKBL1820

VDP ORDERS ONLY



Offer Good Through March 31, 2019 - While Supplies Last

BONUS

GET ITEM BELOW
\$49.99 VALUE!
18V LXT[®] Li-ion Cordless 12 LED Flashlight (Tool Only)

SKU 849456
MAKDML801

VDP ORDERS ONLY



Offer Good Through March 31, 2019 - While Supplies Last

BUY EITHER OF THE TOOLS BELOW - GET THIS

5" Dual Action Random Orbit Polisher

SKU 762481
MAKP05000CX1 **419⁹⁹**

- 7.8 AMP Motor
- 7/32" Orbit Diameter Provides a Swirl-Free Finish
- Variable Speed Control Dial (1,600 - 6,800 OPM)
- Electronic Controller Provides Constant Speed Control



18V LXT[®] Li-ion Cordless Combo Kit

SKU 696478
MAKLT320 **479⁹⁹**

- 3/8" Impact Wrench Provides 155 Ft/Lbs. of Max Torque
- Impact Driver Provides 1,420 In/Lbs. of Max Torque
- Extra Bright 12 LED Flashlight Has 240 Lumens and Rotates Left to Right
- (2) 18V LXT[®] Li-ion 3.0 Ah Batteries that Reach Full Charge in 30 Minutes
- Rapid Optimum Charger Optimize Battery Life By Actively Controlling Current, Voltage, and Temperature
- Tool Bag



BONUS

GET ITEM BELOW
\$134.99 VALUE!
12V Lithium-ion Cordless Combo Kit

SKU 847089
MAKCT226

VDP ORDERS ONLY



Offer Good Through March 31, 2019 - While Supplies Last

18V Tool Kits

18V (36V) LXT[®] Li-ion Brushless Blower Kit w/ 4 Batteries (5.0Ah)

SKU 004135
MAKXBU02PT1 **379⁹⁹**

Kit Includes X2 LXT[®] Li-ion Brushless Blower, Dual-Port Charger and (4) 18V LXT[®] 5.0Ah Batteries

- Delivers Up to 28 Minutes of Run Time at Mid-Speed (15,800 RPM) Using (2) 18V LXT[®] 5.0Ah Batteries
- BL[™] Brushless Motor Delivers Up to 120 MPH Air Velocity and 473 CFM of Air Volume
- Sound Pressure Rating of 60.2 dB
- Zero Emissions and Reduced Maintenance No Need for Gas or Oil
- Features Extreme Protection Technology (XPT[™]) to Provide Increased Dust and Water Resistance in Harsh Job Site Conditions



18V X2 (36V) LXT[®] Li-ion Brushless Cordless 14" Chainsaw Kit w/ 4 Batteries

SKU 004152
MAKXCU03PT1 **439⁹⁹**

Kit Includes X2 LXT[®] Brushless Cordless Chainsaw, Dual-Port Charger and (4) 18V LXT[®] 5.0Ah Batteries

- BL[™] Brushless Motor Direct-Drive System Provides High Power Efficiency Equivalent to a 32cc Gas Chainsaw
- Variable Speed Trigger and High Chain Speed (0-3,940 FPM) for Improved Cutting Performance
- Low Noise Level and Zero Emissions



Tools Only

WORKS WITH MAKITA 18V BATTERIES

18V LXT[®] Li-ion Cordless Recipro Saw (Tool Only)

SKU 912336
MAKXRJ04Z **119⁹⁹**

- Variable Speed Motor Delivers 0-2,800 Strokes per Minute with a 1-1/4" Stroke Length for Faster Cutting
- Tool-less Blade Change System
- Variable Speed Trigger
- Extreme Protection Technology (XPT[™]) Improved Dust and Water Resistance



Tool Only, Does Not Include Battery or Charger

18V LXT[®] Li-ion Cordless 1/2" Driver Drill (Tool Only)

SKU 004137
MAKXFD10Z **119⁹⁹**

- 4-Pole Motor Delivers 480 In/Lbs. of Max Torque and 290 In/Lbs. of PTI Torque
- Variable 2-Speed Motor (0-400 & 0-1,500 RPM)
- Built-in LED Light
- Rubberized Soft Grip Handle
- Equipped with Star Protection Computer Controls[™]



Tool Only, Does Not Include Battery or Charger

18V LXT[®] Li-ion Cordless 1/4" Die Grinder (Tool Only)

SKU 004153
MAKXDG01Z **199⁹⁹**

- Delivers 25,000 RPM for Faster Grinding
- Weighs Only 4.4 Lbs. with Battery (Battery Not Included)
- Vent Slots Direct Exhaust Air Away from the User
- Round-Shaped Collet Nut Reduces the Possibility of Damage
- Stepped Neck for Working in Tight Spaces



Tool Only, Does Not Include Battery or Charger

18V LXT[®] Li-ion Brushless 3/4" Dr Impact Wrench (Tool Only)

SKU 004146
MAKXWT07Z **299⁹⁹**

- BL[™] Motor Delivers 780 Ft/Lbs. of Fastening Torque and 1,250 Ft/Lbs. of Breakaway Torque
- 3-Speed Power Selection Switch
- 3/4" Anvil with Friction Ring and Thru-Hole Retention System
- Efficient BL[™] Brushless Motor for Up to 50% Longer Run Time
- Built-in Dual LED Lights



Tool Only, Does Not Include Battery or Charger

18V Batteries

18V 4.0Ah Li-ion Battery

SKU 849464 | MAKBL1840B

- With Charge Indicator Light

109⁹⁹

18V 5.0Ah Battery

SKU 849454 | MAKBL1850B

- With Charge Indicator Light

129⁹⁹

18V LXT[®] Li-ion 3.0Ah Battery

SKU 949575 | MAKBL1830B

- With Charge Indicator Light

109⁹⁹

18V 3.0Ah Li-ion Battery

SKU 262507 | MAKBL1830

99⁹⁹

18V 2.0Ah Li-ion Battery

SKU 849432 | MAKBL1820B

- With Charge Indicator Light

89⁹⁹

18V 2.0Ah Li-ion Battery

SKU 555436 | MAKBL1820

79⁹⁹



FOR FINANCING PROGRAMS SEE PAGE 2

877-AZTool1
877-298-6651
 Hablamos Español
 AZtool1.com

BONUS TOOL OFFERS VIA MAIL-IN REBATE • OFFERS VALID JANUARY 1, 2019 THROUGH MARCH 31, 2019
 All Mail-in Rebate Requests Must Be Postmarked No Later Than **APRIL 15, 2019** • While Supplies Last for Rebate Form, Go to WWW.DEWALT.COM/FAQS.ASPX and Type "AUTOZONE" in the Search Field



BUY ANY ONE OF THE TOOLS BELOW - GET THIS

20V MAX* XR Brushless High Torque 1/2" Impact Wrench Kit with Detent Pin

SKU 850035
DWTDCF899P1

364⁹⁹

- 1200 Ft/Lbs. of Breakaway Torque
- Max Torque: 700 Ft/Lbs.
- Includes: 20V MAX* XR Brushless High Torque 1/2" Impact Wrench with Detent Pin Anvil, 5.0Ah Battery, (1) Multi Voltage Charger



20V MAX* Li-ion 1/2" High Torque Impact Wrench Kit

SKU 559064
DWTDCF889HM2

384⁹⁹

- 400 Ft/Lbs. of Maximum Torque
- Variable Speed Trigger with Electric Brake
- Hog Ring Anvil



20V Max* 1/2" Brushless High Torque Impact Wrench Kit

SKU 803108
DWTDCF899HP2

464⁹⁹

- 1200 Ft/Lbs. of Break Away Torque
- 700 Ft/Lbs. of Max Torque
- Hog Ring Anvil
- LED Light for Visibility



BUY ANY ONE OF THE TOOLS BELOW - GET THIS

20V MAX* Li-ion Compact Drill / Driver Kit

SKU 559076
DWTDC280C2

279⁹⁹

- Includes DCD780 1/2 In. Drill/Driver and DCF885 1/4 In. Impact Driver
- High Speed Transmission Delivers 2 Speeds (0-600 and 0-2,000 RPM)



20V MAX* Li-ion Compact Drill/Driver Kit

SKU 559042
DWTDCD780C2

229⁹⁹

- Includes DCD780 1/2 In. Drill Driver and (2) 20V Max Lithium-ion Battery Packs Fast Charger
- High Speed Transmission Delivers 2 Speeds (0-600 and 0-2,000 RPM)



20V MAX* Brushless Drill/Impact Kit (2.0Ah)

SKU 850655
DWTDC283D2

339⁹⁹

- Brushless Motor Delivers Up to 57% More Run Time Over Brushed
- XR Li-ion Batteries Provide 33% More Capacity Over Standard



BUY ANY ONE OF THE TOOLS BELOW - GET THIS

20V MAX* Li-ion Grease Gun

SKU 559072
DWTDCGG571M1

279⁹⁹

- Compact, Lightweight Design
- 3 LED Lights Provide Visibility



20V MAX* Li-ion 3/8" Impact Wrench Kit

SKU 559059
DWTDCF883M2

289⁹⁹

- Compact (5.70" Front to Back), Lightweight (3.4 Lbs.) Design
- Three (3) LED Lights with 20 Second Delay After Trigger Release



20V MAX* Li-ion 1/2" Impact Wrench Kit

SKU 559056
DWTDCF880HM2

309⁹⁹

- Compact (5.70" Front to Back), Lightweight (3.4 Lbs.) Design
- Three (3) LED Lights with 20 Second Delay After Trigger Release
- Hog Ring Anvil



BUY ANY ONE OF THE TOOLS BELOW - GET THIS

12V MAX** 1/4 Screwdriver Kit

SKU 559050
DWTDCF610S2

124⁹⁹

- Compact, Lightweight Design Fits Into Tight Areas
- 3 LED Lights Provide Visibility without Shadows



12V MAX** Cordless Li-ion Drill/Driver/Impact Driver Combo Kit

SKU 559074
DWTDC211S2

229⁹⁹

- DCD710 12V MAX** 3/8" Drill/Driver Features 2 Speed Transmission (0-400 and 0-1,500)
- DCF815 12V MAX** 1/4" Impact Driver Features (3) LED Lights



12V MAX** 3/8" Impact Wrench Kit

SKU 559053
DWTDCF813S2

179⁹⁹

- 3/8" Hog Ring Anvil
- 1,150 In/Lbs. of Torque
- Three (3) LED Lights
- Compact, Lightweight Design



BONUS GET ITEM BELOW VIA MAIL-IN REBATE†† UP TO \$149.99 VALUE!

20V MAX* XR 1/4" 3-Speed Impact Driver (Tool Only)

SKU 305937
DWTDCF887B

149⁹⁹

Tool Only, Does Not Include Battery or Charger



BONUS GET ITEM BELOW VIA MAIL-IN REBATE†† UP TO \$94.99 VALUE!

20V MAX* LED Area Work Light (Tool Only)

SKU 695139
DWTDCLO50

94⁹⁹

Tool Only, Does Not Include Battery or Charger



BONUS GET ITEM BELOW VIA MAIL-IN REBATE†† UP TO \$149.99 VALUE!

20V MAX* XR 1/4" 3-Speed Impact Driver (Tool Only)

SKU 305937
DWTDCF887B

149⁹⁹

Tool Only, Does Not Include Battery or Charger



BONUS GET ITEM BELOW VIA MAIL-IN REBATE†† UP TO A \$39.99 VALUE!

12V MAX** LED Work Light (Tool Only)

SKU 559080
DWTDCLE510

39⁹⁹

Tool Only, Does Not Include Battery or Charger



Corded Tools

4-1/2" Small Angle Grinder with One-Touch™ Guard

SKU 559122
DWTDWE4011

69⁹⁹

- 7.0 Amp AC/DC, 12,000 RPM Motor
- One-Touch Guard



6" Bench Grinder

SKU 559118
DWTDW756

114⁹⁹

- Powerful 5/8 HP Induction Motor
- Industrial Cast Iron Base and Motor Housing



4-1/2" Angle Grinder

SKU 695136
DWTDWE402

134⁹⁹

- 7.0 Amp AC/DC, 11,000 RPM Motor
- 2-Position Side Handle
- 4-1/2" One-Touch™ (T27) Guard
- Quick-Change™ Wheel Release Allows Tool Free Wheel Removal



12.0 Amp Compact Reciprocating Saw

SKU 559121
DWTDWE357

134⁹⁹

- Keyless Lever Action Blade Clamp with 4 Positions for Additional Versatility
- Variable Speed Trigger



7" / 9" Variable Speed Polisher

SKU 559123
DWTDWP849

189⁹⁹

- 12.0 Amp
- Electronic Control Maintains Specified Speed Under Load



Lighting

20V MAX* Li-ion LED Work Light (Tool Only)

SKU 559079
DWTDCLO40

54⁹⁹

- Bright LED Output – 110 Lumens

Tool Only, Does Not Include Battery or Charger



20V MAX* LED Area Work Light (Tool Only)

SKU 695139
DWTDCLO50

94⁹⁹

- 3 Bright LED Bulbs
- 2 Brightness Settings
- Pivoting Head

Tool Only, Does Not Include Battery or Charger



20V MAX* Jobsite LED Spotlight (Tool Only)

SKU 012639
DWTDCLO43

99⁹⁹

- 3 Bright LEDs, 1 Red for Night Vision
- Max Output of 1,000 Lumens
- 90 Degree Pivoting Head

Tool Only, Does Not Include Battery or Charger

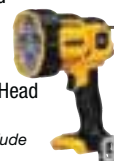

LED Work Light (Tool Only)

SKU 695140
DWTDCLO61

134⁹⁹

- 1,500 Lumens
- Compatible with 18V or 20V Battery
- AC Outlet for Additional Power
- Adjustable Light Head

Tool Only, Does Not Include Battery or Charger



Batteries and Chargers

12V MAX** Li-ion Battery Pack

• Compact, Lightweight Design

• Quick 40 Minute Charge Time

1 Pack

SKU 559033
DWTDCB127

59⁹⁹

2 Packs

SKU 850656
DWTDCB127-2

84⁹⁹



12V MAX**/20V MAX* Li-ion Battery Charger

SKU 559032
DWTDCB115

69⁹⁹

- Charges Current DEWALT 12V MAX**/20V MAX* Li-ion Batteries
- Charges in 1 Hour or Less



7.2V-18V NiCad/NiMH/ Li-ion Fast Charger

SKU 559031
DWTDC9310

89⁹⁹

- Diagnostics with LED Indicator Communicates Battery Charge Status



20V MAX* Battery Packs

- No Memory and Virtually No Self-Discharge
- Compatible with Current Line of DEWALT 20V MAX* Tools

1.5 Ah

SKU 559035 | DWTDCB201

79⁹⁹

3.0 Ah

SKU 559034 | DWTDCB200

109⁹⁹



Premium XR™

SKU 559036 | DWTDCB204

129⁹⁹

Premium XR™ 5.0 Ah

SKU 559037 | DWTDCB205

149⁹⁹

5.0 Ah 2 Pack

SKU 850488 | DWTDCB205-2

199⁹⁹

FLEXVOLT™ 20V/60V MAX Lithium-ion Battery Pack

2 Pack

SKU 912327
DWTDCB606 - 2

209⁹⁹

1 Pack

SKU 762502
DWTDCB606

154⁹⁹



18V XRP™ Battery Pack

SKU 559029
DWTDC9096

109⁹⁹

POWER TOOL ACCESSORIES

Screwdriver and Drill Bit Driver Sets

7 Piece Bolt Extractor Nut Driver Set
OEM TOOLS™
 SKU 298210 22990 **19⁹⁹**

- Reverse Spiral Flutes for Maximum Gripping Power
- SAE Sizes: 3/16", 1/4", 3/8", 7/16", 1/2"
- Metric Sizes: 8 mm, 10 mm
- Chrome Moly Steel Construction
- Use with Impact Driver, Drill and Driver Handle



Spiral Step Drill Set
OEM TOOLS™
 SKU 099189 24372 **24⁹⁹**

- Titanium Coated Finish
- 28 Hole Sizes in 3 Bits
- Bit One: 13 Sizes from 1/8" to 1/2"
- Bit Two: 6 Sizes from 3/16" to 1/2"
- Bit Three: 9 Sizes from 1/4" to 3/4"



70 Piece Impact Drill-Driver Bit Set
Makita
 SKU 847085 MAK2-01725 **34⁹⁹**

- Compatible with 1/4" Impact Drivers and 3/8" or 1/2" Driver/Drills
- UltraLok™ 1/4" Hex Shanks
- Magnetic 3" Bit Holder and Nut Drivers
- Black Oxide Coating to Resist Corrosion
- Compatible with Quick-Change Connector Systems

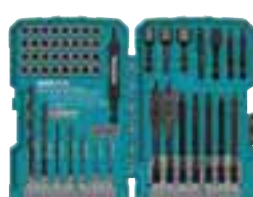

38 Piece Impact Drill and Driver Set
Makita
 SKU 847083 MAK2-01373 **24⁹⁹**

- (4) Black Oxide Drill Bits: 1/16", 3/32", 1/8" and 1/4"
- (3) 3-1/2" Extra Length Drill Bits
- (6) 2" Power Bits: 2-P2, 2-P3, R15 and R20
- (21) 1" Bit Tips: Slotted, Phillips, Robertson and Torx
- (1) 1/4" to 1/4" Hex to Square Adapter
- Injection Molded Case



40 Piece Impact Ready® Screwdriving Set
DEWALT
 SKU 850480 DWTDWA2T40IR **29⁹⁹**

- FlexTorq™ Allows Bits to Flex Up to 15 Degrees
- 10X Magnetic Screw Lock System
- Minimizes Drops and Reduces Wobbling
- Reduces Breakage for Longer Life



21 Piece Pilot Point Titanium Drill Bit Set
DEWALT
 SKU 297498 DWTDW1361 **34⁹⁹**

- Titanium-Coating Lasts Up to Six Times Longer Than Standard Bits
- Suitable for Drilling Through Metal, Wood, and Laminates
- No Spin Shanks
- Tapered Web Provides Greater Durability to Reduce Breaking



45 Piece Screwdriving Set
DEWALT
 SKU 850468 DWTDW2166 **29⁹⁹**

- Most Common Screwdriver Accessories
- Precise Fitment on No. 2 Phillips Bits
- Double-Ended 1" Bits
- Titanium Torsion Bits
- Includes Tough Case



14 Piece Pilot Point Industrial Cobalt Drill Bit Set
DEWALT
 SKU 297460 DWTDWA1240 **29⁹⁹**

- Designed for Maximum Speed and Life
- Pilot Point and Split Tip Design
- No Bit Walking Means More User Control
- For Use on Hard Metals



37 Piece Screwdriving Set
DEWALT
 SKU 849592 DWTDW2163 **29⁹⁹**

- Includes Slotted Bits and Bit Tips
- 10 of the Most-Needed No. 2 Phillips Bit Tips
- Power Bits, Square Recess Bits and a Double Ended Bit
- Compact Magnetic Drive Guide
- Includes Tough Case



80 Piece Screwdriving Set
DEWALT
 SKU 850469 DWTDW2587 **49⁹⁹**

- 17 Black Oxide Drill Bits
- Industrial Screwdriving and Fastening Bits
- Magnetic Bit Tip Tray
- Includes Tough Case



29 Piece Pilot Point Drill Bit Set
DEWALT
 SKU 596975 DWTDW1969 **69⁹⁹**

- No-Spin Shank Eliminates Bit Spinning in the Chuck
- Gold Ferrous Oxide Coating
- Tapered Web Provides Greater Durability to Reduce Breaking
- Size Markings Located Above the Shank to Prevent Wearing Away
- Pilot Point Tips Start on Contact for Clean, Accurate Holes



Grinding Wheels

4-1/2" x 1/4" x 7/8" Metal Grinding Wheel - (10 Pack)
DEWALT
 SKU 850482 DWTDW4514B5 **17⁹⁹**

- Heavy Duty Cutting and Grinding of Ferrous Metals
- High Grain Concentration for Aggressive Grinding Action and Smoother Running Wheels
- 3 Full Sheets of Fiberglass for Durability and Safety
- Proprietary Aluminum Oxide Grain Combination



4-1/2" x 0.045" x 7/8" Metal Cutting Wheel - (2 Pack of 5)
DEWALT
 SKU 850030 DWTDW8424B5 **17⁹⁹**

- Heavy Duty Cutting and Grinding of Ferrous Metals
- Thin .045" Wheel Design for Fast Burr Free Cutting
- Premium Resin Bonds Inspected Before Use
- Proprietary Aluminum Oxide Grain Combination



Bench Grinding Wheel

6" Bench Grinding Wheel
SHARK USA
 SKU 112398 SHA2017 **14⁹⁹**

- 6" x 3/4" Wheel with 1" Arbor Hole with Reducing Bushings 1/2"-5/8"-3/4"
- 46 Grit



Depressed Center Hubless Grinding Wheels 4-1/2" x 1/4" x 7/8" (10 Pack)
SHARK USA
 SKU 459136 SHA12661 **34⁹⁹**

- Fits 4-1/2" Angle Grinder
- Great for Auto Body Work as Well as All Types of Metal Fabrication and Steel Finishing/Removal
- Max. RPM: 11,900



Depressed Center T27 Hub Grinding Wheels 4-1/2" x 1/4" x 5/8" - 11NC (10 Pack)
SHARK USA
 SKU 459155 SHA12662 **44⁹⁹**

- Fits 4-1/2" Angle Grinder with 5/8" - 11NC Arbor
- Great for Auto Body Work as Well as All Types of Metal Fabrication and Steel Finishing/Removal
- Max. RPM: 11,900



14" x 1/8 x 1" Cut-Off Wheel (5 Pack)
SHARK USA
 SKU 459158 SHA12663 **54⁹⁹**

- Use on Stationary Chop Saws
- Max. RPM: 4,400



Reciprocating Saw Blades

4" 14 TPI Saw Blade - 5 Pack
Makita
 SKU 847084 MAK723062-A-5 **19⁹⁹**

- Lasts 10X Longer Than HCS Blades
- 0.035" Blade Thickness
- For Cutting in Metal Under 1/8"
- Pack of 5



6" 14 TPI Saw Blade - 5 Pack
Makita
 SKU 847080 MAK723066-A-5 **19⁹⁹**

- Lasts 10X Longer Than HCS Blades
- 0.035" Blade Thickness
- For Cutting in Metal 1/8"-3/16" Thick
- Pack of 5



9" 18 TPI Saw Blade - 5 Pack
Makita
 SKU 847081 MAK723069-A-5 **19⁹⁹**

- Lasts 10X Longer Than HCS Blades
- 0.035" Blade Thickness
- For Cutting in Metal 1/8"-3/16" Thick
- Pack of 5



Hole Saw Set

6 Piece Bi-Metal Hole Saw Set
OEM TOOLS™
 SKU 547011 24378 **39⁹⁹**

- Slotted Saw Allows for Easier Plug Removal
- Durable Enamel Finish Protects Against Corrosion
- Bi-Metal Construction for Increased Wear Resistance
- Sizes Included: 7/8", 1", 1-1/8", 1-1/4" and 1-1/2" (22 mm, 25 mm, 29 mm, 32 mm and 38 mm)
- Set Comes in a Blow Mold Case



Metal and Wood Cutting Recip Blade Set
DEWALT
 SKU 850474 DWTDW4856 **17⁹⁹**

- Contains 6 Blades
- (4) Metal-Cutting Blades
- (2) Wood-Cutting Blades
- Raker Tooth Design
- 6 Degree Hook Angle



Metal and Wood Cutting Recip Blade Set
DEWALT
 SKU 850473 DWTDW4857 **17⁹⁹**

- Contains 5 Blades
- (3) Metal-Cutting Blades
- (2) Wood-Cutting Blades



8 Piece 2X Recip Blade Set
DEWALT
 SKU 850471 DWTDWA4101 **29⁹⁹**

- (3) 6" 6 TPI Recip Blades
- (3) 6" Premium Cutting Blades
- (1) 9" 10 TPI Recip Blade
- (1) 8" Premium Cutting Blade
- (1) Tough Case



Metal and Wood Cutting Recip Blade Set
DEWALT
 SKU 850475 DWTDW4892 **29⁹⁹**

- (3) 6" Wood-Cutting Blades
- (2) 6" Metal-Cutting Blades
- (3) 8" Metal-Cutting Blades
- (3) 9" Wood-Cutting Blades
- (1) 9" Demolition Blade



Metal and Wood Cutting Recip Blade Set
DEWALT
 SKU 850477 DWTDW4890 **34⁹⁹**

- (5) 6 TPI Wood-Cutting Blades
- (5) 14 TPI Metal-Cutting Blades
- (5) 18 TPI Metal-Cutting Blades
- Includes Tough Case



Ratchets

• CR-V Steel • Knurled Grip

Duralast

3/4" Drive Round Head Ratchet

SKU 914050 **36⁹⁹**
72-130



STORE STOCKED

3/8" Drive Stubby Ratchet

SKU 482540 **22⁹⁹**
73-872



3/8" Drive Comfort Handle Ratchet

SKU 482541 **24⁹⁹**
73-873



1/2" Drive Comfort Handle Ratchet

SKU 557430 **24⁹⁹**
72-127

While Supplies Last

3/8" Drive Super 72 Ratchet

SKU 454285 **26⁹⁹**
73-879

- Sealed Head Keeps Dust and Dirt Out
- 72 Teeth, Fine-Tooth Design Offers 5° Backlash
- Quick Release for Secure Holding of Sockets
- One Finger Reverse Switch



1/2" Drive Super 72 Ratchet

SKU 454286 **29⁹⁹**
72-131

1/4" Quick Release Ratchet

SKU 013645 **17⁹⁹**
71-420

STORE STOCKED

3/8" Ratchet with 1/4" Body

SKU 013644 **19⁹⁹**
73-868

- 72 Tooth Ratchet with 5 Degree Arc Lets You Work in Tight Spaces
- One Handed Forward and Reverse Action



While Supplies Last

STORE STOCKED

Adapters

1/4" M x 3/8" F Adapter.....SKU 482536 | 73-814 **4⁹⁹**

3/8" M x 1/4" F Adapter.....SKU 557436 | 73-816 **4⁹⁹**

3/8" M x 1/2" F Adapter.....SKU 482534 | 73-812 **6⁹⁹**

1/2" M x 3/8" F Adapter.....SKU 482535 | 73-813 **4⁹⁹**

3/4" M x 1/2" F Adapter.....SKU 560449 | 73-413 **5⁹⁹**



Screwdriver Set

28 Piece Speed Driver Screwdriver Set

SKU 013649 **29⁹⁹**
70-000



- 6 Times Faster Than Standard Hand Screwdrivers
- The Double Drive Gear Mechanism Allows Continuous Rotation in Forward or Reverse without Ever Lifting Your Hand
- Comes with 28 Piece Bit Set with Multiple Sizes for Most Applications

STORE STOCKED

Bit Sets

9 Piece XZN Triple Square Bit Set

SKU 013563 **24⁹⁹**
70-070

- These Hard to Find Bits are for Tightening and Loosening Head Bolts, Brake Caliper Bolts, Door Handles, Screws, Axle Bolts, and Other Applications Found on Many European Vehicles
- Includes 1/4", 3/8" and 1/2" Drives
- 1/2" Drives are Tamper Proof



STORE STOCKED

11 Piece 5-Lobe Tamper-Proof Star Plus Bit Set

SKU 013553 **24⁹⁹**
70-071

- These Hard to Find Bits are for Tightening and Loosening Electrical Sensors, Interior, Dash, Body and Trim Pieces Along with Other Applications Found on Many European Vehicles
- Includes 1/4", 3/8" and 1/2" Drives
- S2 Steel



STORE STOCKED

Ratcheting Wrench Sets

Ratcheting Wrenches are Precision Engineered with 5° Swing Arc Action to Get Into the Tightest Spots

7 Piece Slip Resistant Ratcheting Wrench Set

SKU 607062 (Metric) **51⁹⁹**
70-023

- Metric: 8, 10, 12, 13, 14, 15 and 18 mm

SKU 607063 (SAE) **49⁹⁹**
70-024

- SAE: 5/16", 3/8", 7/16", 1/2", 9/16", 5/8" and 3/4"



STORE STOCKED

4 Piece Double Offset Ratcheting Wrench Set

SKU 561039 SAE **59⁹⁹**
70-015

- SAE: 5/16" x 3/8", 7/16" x 1/2", 9/16" x 5/8" and 11/16" x 3/4"



While Supplies Last

2 Piece Double Duty Wrench Set 8 Wrenches for the Price of 2

SKU 951644 (Metric) **29⁹⁹**
70-008

- Metric: 8, 10, 12, 13, 14, 17, 18 and 19 mm
- SAE: 5/16", 3/8", 7/16", 1/2", 9/16", 5/8", 11/16" and 3/4"



SKU 951643 (SAE) **29⁹⁹**
70-009

STORE STOCKED

Screwdriver Set

20 Piece Screwdriver Set

SKU 363800 **24⁹⁹**
70-204

Set Includes:

- Slotted: 3/32" x 2", 1/8" x 2-1/2", 3/16" x 4", 1/4" x 4", 1/4" x 6", 1/4" x 1-1/2", Offset Screwdriver
- Phillips: #00 x 1-1/2", #0 x 2-1/2", #1 x 3", #2 x 4", #2 x 6", #2 x 1-1/2"; Star: #15, #20, #2 Square Plus 4 Piece Hook and Pick Set
- Acetate Handles



Spark Plug Sockets

5/8" x 6" Magnetic Spark Plug Extension

SKU 454330 **12⁹⁹**
75-499

- Chrome Vanadium for Strength
- Fully Polished to Resist Rust
- 3/8" Drive
- Color Coded Blue - SAE



9/16" x 6" Magnetic Spark Plug Extension

SKU 454328 **14⁹⁹**
75-498

- Chrome Vanadium for Strength
- Fully Polished to Resist Rust
- 3/8" Drive
- Color Coded Blue - SAE



STORE STOCKED

Flare Nut Wrenches

Flare Nut Wrench Set (SAE)

SKU 914117 **15⁹⁹**
70-026

- SAE: 3/8" x 7/16", 1/2" x 9/16" and 5/8" x 11/16"



STORE STOCKED

Pliers

Slip Joint Pliers

6" Slip Joint.....SKU 482480 | 77-016 **6⁹⁹**

8" Slip Joint.....SKU 482481 | 77-018 **6⁹⁹**

6.5" Diagonal.....SKU 482485 | 77-206 **7⁹⁹**

8" Linesman.....SKU 482487 | 77-308 ... **17⁹⁹**

6.5" Long Nose.....SKU 482483 | 77-106 **7⁹⁹**

8" Long NoseSKU 482484 | 77-108 **8⁹⁹**

Sawtooth Jaw Parrot Nose Locking Pliers

8.5" ParrotSKU 013647 | 77-513 **19⁹⁹**

Wrenches

Wrenches are Forged with Longer Shanks for Extra Leverage

Metric

7 mm Combo Wrench..... SKU 482606 | 79-007 **6⁹⁹**

8 mm Combo Wrench..... SKU 482607 | 79-008 **6⁹⁹**

9 mm Combo Wrench..... SKU 482608 | 79-009 **7²⁹**

10 mm Combo Wrench .. SKU 482609 | 79-010 **7⁹⁹**

11 mm Combo Wrench .. SKU 482610 | 79-011 **7⁹⁹**

12 mm Combo Wrench .. SKU 482611 | 79-012 **7⁹⁹**

13 mm Combo Wrench .. SKU 482613 | 79-013 **7⁹⁹**

14 mm Combo Wrench .. SKU 482614 | 79-014 **8⁹⁹**

15 mm Combo Wrench .. SKU 482615 | 79-015 **8⁹⁹**

16 mm Combo Wrench .. SKU 482616 | 79-016 **8⁹⁹**

17 mm Combo Wrench .. SKU 482617 | 79-017 **8⁹⁹**

18 mm Combo Wrench .. SKU 482618 | 79-018 **9⁹⁹**

19 mm Combo Wrench .. SKU 482619 | 79-019 **9⁹⁹**

20 mm Combo Wrench .. SKU 482621 | 79-020 .. **10⁹⁹**

21 mm Combo Wrench .. SKU 482622 | 79-021 .. **10⁹⁹**

22 mm Combo Wrench .. SKU 482623 | 79-022 .. **10⁹⁹**

23 mm Combo Wrench .. SKU 482624 | 79-023 .. **12⁹⁹**

24 mm Combo Wrench .. SKU 482625 | 79-024 .. **12⁴⁹**

SAE

1/4" Combo Wrench..... SKU 482626 | 79-100 **6⁹⁹**

5/16" Combo Wrench SKU 482627 | 79-101 **6⁹⁹**

3/8" Combo Wrench..... SKU 482628 | 79-102 **6⁹⁹**

7/16" Combo Wrench SKU 482629 | 79-103 **6⁹⁹**

1/2" Combo Wrench..... SKU 482630 | 79-104 **6⁹⁹**

9/16" Combo Wrench SKU 482631 | 79-105 **6⁹⁹**

5/8" Combo Wrench..... SKU 482632 | 79-106 **6⁹⁹**

11/16" Combo Wrench .. SKU 482633 | 79-107 **8⁹⁹**

3/4" Combo Wrench..... SKU 482634 | 79-108 **8⁹⁹**

13/16" Combo Wrench .. SKU 482635 | 79-109 **9⁹⁹**

7/8" Combo Wrench..... SKU 482636 | 79-110 **9⁹⁹**

15/16" Combo Wrench .. SKU 482637 | 79-111 .. **11⁹⁹**

1" Combo Wrench SKU 482639 | 79-112 .. **13⁹⁹**

1-1/16" Combo Wrench ... SKU 482640 | 79-113 .. **14⁹⁹**

1-1/8" Combo Wrench ... SKU 482641 | 79-114 .. **15⁹⁹**

1-1/4" Combo Wrench ... SKU 482642 | 79-115 .. **16⁹⁹**

Wide Mouth Adjustable Wrenches

- Chrome-Plated Finish Resists Rust
- Jaws Open Extra Wide for Added Versatility
- Ruler for Quick, Accurate Adjustment



6" AdjustableSKU 482601 | 78-006 **8⁹⁹**

8" AdjustableSKU 482602 | 78-008 **9⁹⁹**

10" AdjustableSKU 482603 | 78-010 .. **11⁹⁹**

12" AdjustableSKU 482605 | 78-012 .. **15⁹⁹**

STORE STOCKED

HAND TOOLS



Stay Organized

- A Soft Foam Tray with Hi-Vis Cut Outs
- Sized to Maximize Tool Drawer Space
- Each Tool Size is Clearly Marked

ORGANIZED TOOLS SAVE TIME AND MONEY

EVA Trays Feature a Custom Cut Contrast Soft Foam to Keep Your Tools Organized

80 Piece 1/4" Ratchet and Socket Set

SKU 087605
23982 **99⁹⁹**

- Features a 90 Tooth Ratchet with 4 Degree Arc to Get into Tight Spaces
- (10) 1/4" Drive 6-Point SAE Sockets, Sizes 3/16" - 9/16"
- (12) 1/4" Drive 6-Point Metric Sockets, Sizes 5 mm-15 mm
- (10) 1/4" Deep Drive 6-Point SAE Sockets, Sizes 3/16" - 9/16"
- (12) 1/4" Deep Drive 6-Point Metric Sockets, Sizes 5 mm-15 mm
- Extension Bar
- Universal Joint
- 32 Piece Bit Set with 72-Tooth 1/4" Mini Ratchet
- Comes in Sturdy Blow Molded Case and Tools are Set in a Removable EVA Tray



31 Piece 3/8" Drive Mechanic's Set

SKU 802210
23998 **79⁹⁹**

- Featuring 36 Teeth Sealed Head 3/8" Ratchet
- 3/8" Drive Sockets, 6-Pt: 8, 9, 10, 11, 12, 13, 14, 15, 16, 17, 18 and 19 mm
- 3/8" Drive Deep Sockets, 6-Pt: 8, 9, 10, 11, 12, 13, 14, 15, 16, 17, 18 and 19 mm
- 3/8" Wobble Extensions: 3", 6" and 12"
- 3/8" Universal Joint
- 3/8" Spark Plug Sockets: 5/8" and 9/16"

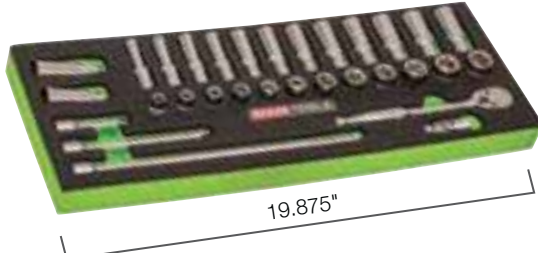

Sealed Head Mechanism

Ratchet heads are sealed to keep dirt and debris out. Heads are fully re-buildable and repair parts are available.



64 Piece 1/4" Drive Mechanic's Set

SKU 020788
23997 **99⁹⁹**

- Shallow Sockets, 6 Pt: 4, 4.5, 5, 5.5, 6, 7, 8, 9, 10, 11, 12, 13, 14 and 15 mm
- Deep Sockets, 6 Pt: 4, 4.5, 5, 5.5, 6, 7, 8, 9, 10, 11, 12, 13, 14 and 15 mm
- 1/4" Drive Wobble Straight Extension
- 1/4" x 1/4" Extension
- Bit Extension Bars: 6" and 10"
- Ratchet Screwdriver
- 1/4" Drive Universal Joint
- 1/4" Drive Ratchet
- 28 Bits: Square: 1, 2, 3; Slotted: 6-8, 8-10, 10-12, 1/4; Phillips: #1, #1, #2, #2, #2, #3; Torx: T8, T10, T15, T20, T25, T27, T30; Torx Tamper: TT8, TT10, TT15, TT20, TT25, TT27, TT30

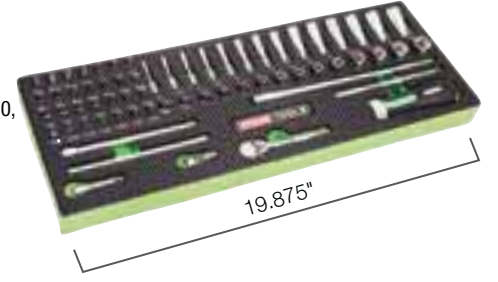

EVA Locking Pliers Set

7 Piece Locking Pliers Set

SKU 012622
23987 **64⁹⁹**

- Sizes: 4", 5", 7", 10" Curved Jaw and 4", 6", 9" Long Nose

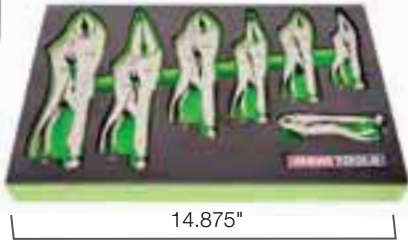

EVA Screwdriver Set

8 Piece Mechanic's Screwdriver Set

SKU 802208
23999 **59⁹⁹**

- Slotted: 1/4" x 1-1/2", 3/16" x 3", 1/4" x 4", 5/16" x 6" and 3/8" x 8"
- Phillips: #2 x 1.5", #1 x 3" and #2 x 4"

Black Magnetic Tip

Hex Bolster Hex shaped bolster for when you need more turning power

Unique Ergonomic Handle 3 sided handle feels good in your hands



EVA Bit Sets

44 Piece Multi-Drive Star Socket Set

SKU 802206
23992 **49⁹⁹**

- 1/4" Bit Holder
- 1/4" Hex Drive Tamper-Proof Star Bits: T7, T8, T9, T10, T15, T20, T25, T27 and T30
- 1/4" Drive Star: T10, T15, T20, T25, T27 and T30
- 3/8" Drive Star: T40, T45, T47, T50, T55 and T60
- 3/8" Drive Metric Hex: 2, 2.5, 3, 4, 5, 6, 7, 8 and 10 mm
- 3/8" Drive SAE Hex: 1/8", 5/32", 3/16", 7/32", 1/4", 5/16" and 3/8"
- 3/8" Drive Phillips: #1, #2 and #3
- 3/8" Drive Slotted: 3/16", 1/4" and 5/16"

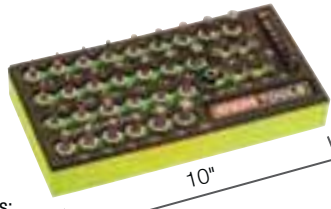

35 Piece Multi-Drive Star Socket Set

SKU 802217
23991 **39⁹⁹**

- 1/4" Drive Star: T10, T15, T20, T25, T27 and T30
- 1/4" Drive Tamper-Proof Star: T7, T8, T9, T10, T15, T20, T25 and T30
- 1/4" Drive Female Star: E4, E5, E6, E7 and E8
- 3/8" Drive Star: T40, T45, T47, T50 and T55
- 3/8" Drive Tamper-Proof Star: T40, T45, T50 and T55
- 3/8" Drive Female Star: E10, E12, E14 and E16
- 1/2" Drive Star: T60 and T70
- 1/2" Drive Female Star: E18

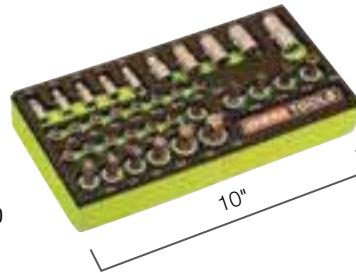

26 Piece Master Hex Bit Set

SKU 802219
23990 **44⁹⁹**

- 1/4" Drive: 1/8", 5/32", 3/16" and 7/32"
- 3/8" Drive: 1/4", 9/32", 5/16" and 11/32"
- 1/2" Drive: 3/8", 1/2", 9/16", 3/4" and 5/8"
- 1/4" Drive: 2.5, 3, 4 and 5 mm
- 3/8" Drive: 6, 7, 8 and 9 mm
- 1/2" Drive: 10, 12, 14, 17 and 19 mm

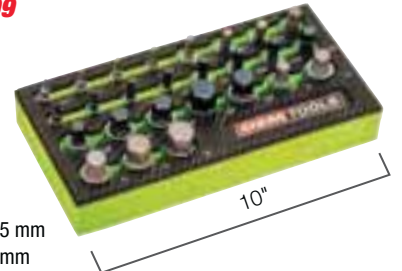

EVA Socket Sets

10 Piece 1/4" Deep Socket Set (SAE)

SKU 850056
23985 **24⁹⁹**

- Includes Sizes: 3/16", 7/32", 1/4", 9/32", 5/16", 11/32", 3/8", 7/16", 1/2" and 9/16"

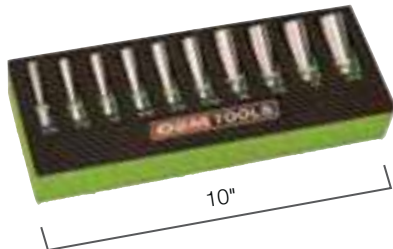

12 Piece 1/4" Deep Socket Set (Metric)

SKU 850510
23986 **24⁹⁹**

- Includes Sizes: 5, 5.5, 6, 7, 8, 9, 10, 11, 12, 13, 14 and 15 mm



Knurled Base for Firmer Grip

Chamfered Ends Chamfered ends on bits and sockets make fastener engagement quick and smooth

12 Piece 3/8" Deep Socket Set (Metric)

SKU 103402
23981 **49⁹⁹**

- Sizes: 8 mm-19 mm



42 Piece 3/8" Impact Socket Set

SKU 87600
23983 **99⁹⁹**

- (8) 3/8" Drive 6-Point SAE Sockets, Sizes 5/16"-3/4"
- (12) 3/8" Drive 6-Point Metric Sockets, Sizes 8mm-19mm
- (8) 3/8" Deep Drive 6-Point SAE Sockets, Sizes 5/16"-3/4"
- (12) 3/8" Deep Drive 6-Point Metric Sockets, Sizes 8mm-19mm
- Extension Bar
- Universal Joint Bar



EVA Wrench Sets

RingStop® Reversible Ratcheting Wrench Set

- Patented RingStop Design Makes One-Hand Use Easy
- Posi-Grip No-Slip® Design

- Jaw is 15° Offset
- Made with Chrome Vanadium Steel

8 Piece Set (SAE)

SKU 803139
23989 **109⁹⁹**

- SAE Sizes: 5/16", 3/8", 7/16", 1/2", 9/16", 5/8", 11/16" and 3/4"



12 Piece Set (Metric)

SKU 803140
23988 **119⁹⁹**

- Metric Sizes: 8, 9, 10, 11, 12, 13, 14, 15, 16, 17, 18 and 19 mm



5 Piece Flex Head Flare Nut Wrench Set (SAE)

SKU 749849
22063 **59⁹⁹**

6 Piece Flex Head Flare Nut Wrench Set (Metric)

SKU 749930
22064 **69⁹⁹**



Combo Wrench Set

14 Piece (SAE)

SKU 802222
23993 **109⁹⁹**

- 1/4", 5/16", 3/8", 7/16", 1/2", 9/16", 5/8", 11/16", 3/4", 7/8", 15/16", 1", 1-1/16" and 1-1/8"

16 Piece (Metric)

SKU 802224
23994 **109⁹⁹**

- 6, 7, 8, 9, 10, 11, 12, 13, 14, 15, 16, 17, 18, 19, 21 and 22 mm



BONUS VALUE: \$19.99

8 Piece Go Thru Socket Set (SAE)

SKU 807946 | 22979

Offer Good Through March 31, 2019 - While Supplies Last

BONUS VALUE: \$29.99

12 Piece Go Thru Socket Set (Metric)

SKU 807945 | 22978

Offer Good Through March 31, 2019 - While Supplies Last

Turning Power Open End Has 15° Offset So You Can Flip It Quickly For A Better Grip



Mechanic's Sets

26 Piece 1/2" Drive Ratchet and Socket Set

SKU 591154 23995 **99⁹⁹**

- Includes: (21) 6 Pt. Metric and SAE Sockets
 (1) 1/2" Drive Extension Bar 3"
 (1) 1/2" Drive Extension Bar L6
 (1) 1/2" Swivel U-Joint
 (1) 1/2" Drive Regular Ratchet



121 Piece Mechanic's Tool Set

SKU 850892 23984 **129⁹⁹**

Multi-Drive Set 1/4" and 3/8"

- Heavy Duty Blow Mold Case
- Includes: Combo Wrenches; 1/4" and 3/8" Drive Sockets; Extension Bars and Ratchets; Long Nose, Diagonal, and Groove Joint Pliers, Reducing Adapters; Ratcheting Screwdriver with 6" Bit Driver Blade; 33 Piece Chrome Plated Bit Set; SAE and Metric Hex Key Sets and More



POSI-GRIP NO-SLIP®
 Socket Off Corner Loading for Greater Torque and More Socket-to-Fastener Contact



OEM TOOLS™

SEALED Head RATCHETS to Keep Out Dirt and Debris
 Smooth Satin Finish is Easy to Clean, Won't Show Prints and Keeps Rust Away

PRECISION MACHINED JAWS
 Precise Gripping and Maximum Strength

EVA Chisel Sets

11 Piece Punch and Chisel Set

SKU 802227 23996 **44⁹⁹**

- Tapered Punches: 3/32" x 8 mm x 5-1/4", 5/32" x 10 mm x 6", 3/16" x 12 mm x 6-1/4"
- 3 Piece Pin Punches: 3/32" x 8 mm x 4-1/4", 5/32" x 10 mm x 5", 3/16" x 10 mm x 5-1/4"
- Center Punches: 3/16" x 12 mm x 6"
- Cold Chisels: 3/8" x 8 mm x 5-1/2", 1/2" x 10 mm x 6", 5/8" x 12 mm x 6-1/2"
- 1 Gauge



OEM TOOLS™

Screwdriver Set

8 Piece Screwdriver Set

SKU 127934 22970 **39⁹⁹**

- Set Includes:
 #2 x 1-1/2", #2 x 4", #1 x 3", 1/4" x 1-1/2", 3/16" x 3", 1/4" x 4", 5/16" x 6", 3/8" x 8"
- Magnetic Tips for Gripping Power
- Sand Blasted Tips Resist Chrome Flaking
- Bolstered End to Add Wrench for Even More Torque Power
- Patented 3-Sided Handle

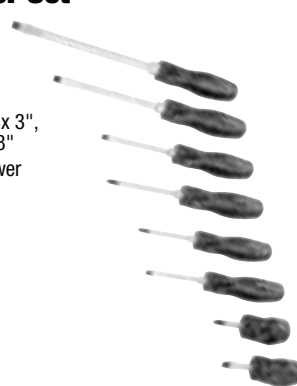

OEM TOOLS™

7 Piece Screwdriver Set with Code Blue Grips

SKU 081330 CHASD-7CB **28⁹⁹**

- Set Includes:
 Slotted 1/4" x 4", 1/4" x 6", 3/16" x 4", 3/8" x 8" and Phillips #1 x 4", #2 x 4", #3 x 6" Code Blue® Screwdrivers
- Magnetic Tips for Ease of Use
- Go-Thru Steel Blades for Added Strength
- Laser Etched Steel Caps for Easy Identification
- High Torque 3-Sided Hold-E-Zee Code Blue Grips

CHANNEL LOCK



Bit Sets

Security Bit Set - 33 Piece

SKU 012671 25959 **10⁹⁹**

- Set Includes: Torq (3), Spanner (4), Tri-wing (4), Metric Hex Security (6), SAE Hex Security (6), Tamper-Proof Star (9), Storage Case and 1/4" Hex Bit Adapter



OEM TOOLS™

Compact Bit Driver Set

SKU 447158 25945 **10⁹⁹**

- Includes: Phillips (#1, #2, #3), Slotted (3/16", 1/4", 5/16"), Star (T15, T20, T25 and T30) with Magnetic Extension
- Ergonomic Case Converts to Driver



Ratcheting Screwdrivers

Pivot-Grip Ratcheting Screwdriver

SKU 004103 22557 **19⁹⁹**

- Pivoting Handle Provides Ergonomic Gripping Positions
- Forward and Reverse Ratcheting
- Includes (6) Bits: Phillips (#1, #2), Slotted (4 mm, 6 mm) and Robinson (#1, #2)



Pivoting Handle

Internal Bit Storage

OEM TOOLS™

29 Piece Dual Drive Screwdriver Set

SKU 081322 25999 **21⁹⁹**

- Dual Drive Technology is 2x's Faster than Standard Ratcheting Screwdrivers
- 150 mm Flexible Shaft
- 20 Piece Bit Set with Plastic Dispenser
- 6 Piece Power Nut Driver Bits



Knives

Utility Knife and Blade Dispenser Set - 2 Pack

SKU 765561 25540 **27⁹⁹**

- Includes: Lockback® Utility Knife, Auto-Loading Lockback® Utility Knife, (2) 50-Pack Blade Dispensers
- Auto-Loading Utility Knife Holds (3) Blades and Features a Blade Release Button for Quick Blade Replacement
- Extra-Wide Handles for Increased Comfort and Leverage



OEM TOOLS™

Precision Drivers

Precision Screwdriver Set - 6 Piece

- Magnetic Tips to Secure Fasteners
- Constructed with Durable Chrome-Vanadium Steel

Star Screwdriver Set

SKU 003763 22559 **14⁹⁹**

- Set Includes: T5, T6, T7, T8, T9 and T10

Screwdriver Set

SKU 003751 22560 **14⁹⁹**

- Slotted Screwdrivers: (1.4, 2, 2.4 and 3 mm)
- Phillips Screwdrivers: (#0 and #1)



OEM TOOLS™

Pry Bars

Light Duty Smoothing / Prying Kit - 3 Piece

SKU 4111 25084 **19⁹⁹**

- Pry Dashboard Parts and Vents without Damaging Interior
- Clean Crevices and Joints in Small Electronics
- Disassemble Key Fobs and Other Remotes
- Evenly Smooth Epoxy and Adhesives

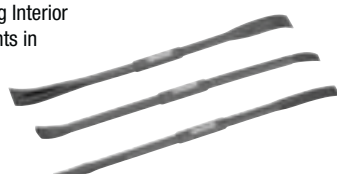

OEM TOOLS™

5/8" x 36" Pry Bar

SKU 695126 24435 **34⁹⁹**

- 3-Sided Handle for Secure Grip and Comfort
- Forged and Hardened 5/8" Square Stock for Incredible Strength



3 Piece Pry Bar Set

SKU 626114 24433 **39⁹⁹**

- Pry Bar Sizes: 3/8" x 12", 7/16" x 18" and 7/16" x 24"
- 3 Sided Handle for Secure Grip and Comfort
- Handles are Solvent Resistant and Easy to Clean



Pick-Up Tools

Heavy Duty Telescopic Magnetic Pick-Up Tool

SKU 231205 25466 **7⁹⁹**

- Lifts Up to 3 Lbs.
- Telescoping Handle Range 6" to 33" with a Steel J-Hook



3-in-1 Pick-Up Tool Magnet, Claw and LED Light

SKU 110277 25293 **14⁹⁹** Reg. \$19.99

- 24-1/2" Flexible Reach

- FEATURES:**
- LED Tip
 - 4 Claws
 - Magnetic Base



Offer Good Through March 31, 2019 While Supplies Last

OEM TOOLS™

SAVE \$5

Jumbo Picks

4 Piece 15" Jumbo Pick Set

SKU 094658 25940 **27⁹⁹**

- Includes: Straight, 90°, Offset and Hook Pick
- Chrome Vanadium Steel for Strength and Durability
- Cushion Grip Handles



OEM TOOLS™

Color May Vary

HAND TOOLS

OEM TOOLS™



JUMBO WRENCHES

Jumbo Wrenches Are Made of High Quality Drop Forged Steel and Are Precision Machined to Prevent Fastener Damage

Part#	SKU	Metric of SAE	Size	PRICE
22101	338833	SAE	1-1/2", 1-5/8", 1-3/4", 1-7/8", 2"	79 ⁹⁹
22100	338830	SAE	1-1/16", 1-1/8", 1-1/4", 1-5/16", 1-3/8", 1-7/16"	59 ⁹⁹
22120	338852	Metric	21 mm, 22 mm, 24 mm, 25 mm, 27 mm, 29 mm, 30 mm, 32 mm	54 ⁹⁹
22121	338858	Metric	33 mm, 34 mm, 35 mm, 36 mm, 40 mm, 42 mm, 46 mm, 50 mm	99 ⁹⁹

Continuous Curve Design Reduces Spreading, Slippage, and Fastener Damage



Box End Offset 15 Degrees for Work in Tight Spaces



Works on Both 6 Point and 12 Point Fasteners



Sets Include Heavy Duty Vinyl Roll-Up Storage Bag
Vinyl Storage Bag May Vary in Style

Jumbo Angle Head Wrench Set - 6 Piece

SKU 912341 **89⁹⁹**
22113

- Constructed with Durable Carbon Steel
- Includes Sizes: 1-3/8", 1-1/2", 1-5/8", 1-3/4", 1-7/8" and 2"

Adjustable Wrenches

8" Ratcheting Adjustable Wrench

SKU 255655 **25⁹⁹**
22658

- Patented 8" Self-Ratcheting Function Allows for Fast Reversing
- Spring-Loaded Ratcheting Mechanism Releases Tension on One of the Jaws
- High Torque Exceeds ASME Breaking Test Standards
- Ideal for Limited Space and Hard-to-Reach Areas
- Matte Chrome Finish Resists Rust

Spring-Loaded Ratcheting Mechanism



OEMTOOLS™ Adjustable Wrenches

- Made with Special Alloy Steel, Heat Treated
- Deep Marking for Easy Identification
- Turn Screw to Adjust Pressure and Fit Work
- Easy Release Trigger for Greater Control
- Nickel Chrome Plated Steel Won't Rust
- Flat Profile is Comfortable in Hands

Part#	SKU	Size	Price
22650	081268	4"	6 ⁹⁹
22651	081269	6"	7 ⁹⁹
22652	081271	8"	9 ⁹⁹
22653	081273	10"	11 ⁹⁹
22654	081274	12"	14 ⁹⁹

OEM TOOLS™



ChannelLock® Adjustable Wrenches

CHAN NUT LOCK

- Longer Jaws Grip Better, Thinner Jaws Give Greater Access in Tight Spaces
- Measurement Scales are Handy for Sizing Nuts, Pipe and Tube Diameters
- Greater Jaw Capacity Supports Larger Nuts and Bolts
- 4 Threaded Knurl & Non-Protruding Jaws Provide Greater Capacity; Minimal Head Width Improves Performance in Confined Space

Part#	SKU	Size	Price
CHA806W	082861	6"	17 ⁹⁹
CHA808W	082862	8"	19 ⁹⁹
CHA810W	082863	10"	22 ⁹⁹
CHA812W	082865	12"	32 ⁹⁹
CHA815	082866	15"	54 ⁹⁹
CHA818	082868	18"	99 ⁹⁹
CHA824	082870	24"	199 ⁹⁹



Specialty Wrenches

15" Chain Wrench

SKU 452624 **34⁹⁹**
22659

- Excellent for Objects of Various Sizes
- Designed for Tight Spaces When Ordinary Wrenches Can't Fit
- Double-Action Allows Use in Either Direction



90° Swedish Pattern Pipe Wrench

SKU 081284 **54⁹⁹**
KNP8310010

- Jaws with Offset Teeth in Opposite Directions
- Teeth Additionally Induction Hardened
- I-Beam Handle Style to Keep Handles Close Together While Still Getting the Full Capacity in the Jaws
- Quick Adjustment by Spinning the Nut
- German Chrome Vanadium Steel; Forged, Oil-Hardened



90° Swedish Pattern "S-Type" Pipe Wrench

SKU 081285 **49⁹⁹**
KNP8330005

- Set Includes: Slotted 1/4" x 4", 1/4" x 6", 3/16" x 4", 3/8" x 8" and Phillips #1 x 4", #2 x 4", #3 x 6" Code Blue® Screwdrivers
- Magnetic Tips for Ease of Use
- Go-Thru Steel Blades for Added Strength
- Laser Etched Steel Caps for Easy Identification
- High Torque 3-Sided Hold-E-Zee Code Blue Grips



KNIPEX®

Combination Wrench Sets

Combination Wrench Sets

- Off Corner Loading for Greater Torque with More Socket-to-Fastener Contact
- Longer Shaft for Extra Leverage
- Exceeds ANSI Standards
- 12 Point End Design Which Allows 15° Backward Movement to Re-Engage Fastener
- Smooth Open End Won't Mark Fasteners

9 Piece (SAE)

SKU 127906 **39⁹⁹**
22996

- Includes Sizes: 5/16", 3/8", 7/16", 1/2", 9/16", 5/8", 11/16", 3/4", 13/16"

10 Piece (Metric)

SKU 127920 **44⁹⁹**
22995

- Includes Sizes: 10, 11, 12, 13, 14, 15, 16, 17, 18, 19 mm

OEM TOOLS™
HARD CHROME™ FINISH

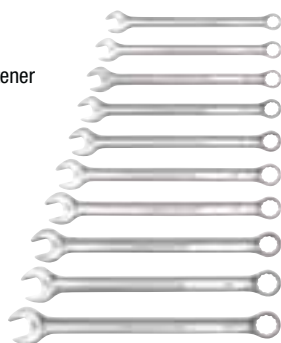

DID YOU KNOW?

AutoZone® has availability on MOOG® Hub Bearing Assemblies.

Contact Your AutoZone Commercial Sales Manager for Details

Dead Blow Hammers

TRUSTY-COOK
INCORPORATED

Professional Grade Quality

- One Piece, Hot Cast Polyurethane Construction
- Safety Red
- Maximum Dead Blow Non-Bounce Action
- Textured, Non-Slip, Comfort Contoured Handle

Dead Blow Ball Peen



Soft Face Hammers

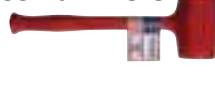

Soft Face Sledge Hammers



Product	Part #	SKU	Weight	Face Diameter	Head Length	Overall Length	Price
Ball Peen - 26	TCH26BP	420347	26 Oz.	1"	4.1875"	12.75"	39 ⁹⁹
Ball Peen - 36	TCH36BP	420349	36 Oz.	1.25"	4.5"	13"	44 ⁹⁹
Ball Peen - 47	TCH47BP	420351	47 Oz.	1.75"	4.8125"	13.625"	49 ⁹⁹
Ball Peen - 50	TCH50BP	420352	50 Oz.	1.75"	4.8125"	16.5"	59 ⁹⁹
Soft Face Hammer - 1	TCH1	420343	21 Oz.	1.75"	3.75"	11.25"	19 ⁹⁹
Soft Face Hammer - 2	TCH2	420344	26 Oz.	2"	4.125"	12.75"	24 ⁹⁹
Soft Face Hammer - 13	TCH3	420345	45 Oz.	2.25"	4.1625"	14.375"	29 ⁹⁹
Soft Face Hammer - 4	TCH4	420346	53 Oz.	2.75"	5.375"	15.25"	44 ⁹⁹
Soft Face Sledge - 7	TCH7	420353	5.5 Lbs.	2.75"	7"	20"	59 ⁹⁹
Soft Face Sledge - 14	TCH14	420354	12 Lbs.	3.25"	8"	36"	129 ⁹⁹

OEM TOOLS™

3 Piece Dead Blow Hammer Set

SKU 900804 **17⁹⁹**
25517

- 1/2 Lb., 1 Lb. and 2 Lbs.
- Soft Rubber Handles for Non-Slip Grip
- Steel Shot Filled for More Force
- Non-Spark Material Used





FREE OVERNIGHT SHIPPING
WITH MOST ORDERS
SEE PAGE 3 FOR DETAILS

Socket Adapters

3 Piece Low Profile Adapter Set

SKU 818570
22535 **12⁹⁹**

- CR-V Steel for Strength
- Get into Tighter Spaces
- Includes Sizes: 1/4" F x 3/8" M, 3/8" F x 1/2" M and 1/2" F x 3/4" M



2 Piece Reducing Adapter Set

SKU 390937
25178 **14⁹⁹**

- Reduces Larger Drive Sizes Down for Use on Smaller Drive Tools
- Set Contains 1/4" Female x 3/8" Male and 3/8" Female x 1/2" Male



3/8" F x 1/2" M Adapter

SKU 081230
22532 **4⁹⁹**



3/8" F x 1/4" M Adapter

SKU 081232
22533 **4⁹⁹**

1/4" F x 3/8" M Adapter

SKU 081233
22534 **4⁹⁹**

OEM TOOLS™

1/2" F x 3/4" M Adapter

SKU 081228
22530 **10⁹⁹**

1/2" F x 3/8" M Adapter

SKU 081229
22531 **7⁹⁹**

Universal Joint

OEM TOOLS™

45° Universal Joint Set with Locking Feature

SKU 447155
24271 **19⁹⁹**

3/8" Drive
SKU 081226
22521 **7⁹⁹**



1/4" Drive

SKU 081225
22520 **6⁹⁹**

1/2" Drive

SKU 081227
22522 **8⁹⁹**

Extensions

OEM TOOLS™

Extensions

- Chamfered Ends for Positive Engagement with Drive Tools
- Knurled Shank for Easy Fingertip Turning
- Milled Ends Provide a Solid Connection



Part #	SKU	Drive	Length	Price
22480	081212	1/4"	2"	4⁹⁹
22481	081213	1/4"	4"	4⁹⁹
22482	081215	1/4"	6"	4⁹⁹
22483	081218	1/4"	11"	4⁹⁹
22490	081219	3/8"	1-3/4"	3⁹⁹
22491	081220	3/8"	3"	4⁹⁹
22492	306326	3/8"	6"	5⁹⁹
22494	306287	3/8"	10"	6⁹⁹
22495	306279	3/8"	18"	9⁹⁹
22500	081221	1/2"	3"	6⁹⁹
22501	081223	1/2"	6"	8⁹⁹
22502	081224	1/2"	10"	12⁹⁹

Ratchets

- 36 Teeth with 10 Degree Arc Motion for Precision and Strength
- Reversing Lever Allows a Forward and Reverse in One-Hand Action
- Sealed to Keep Dirt and Debris Out of Head
- Compact Head Designed to Get into Tight Spaces
- Fully Re-Buildable Head with Repair Parts Available

1/4" Drive Standard Ratchet - 4-1/4"

SKU 081298
22900 **15⁹⁹**



3/8" Drive Stubby - 4"

SKU 177702
22910 **17⁹⁹**



3/8" Drive Standard - 8" 1/2" Drive Standard Ratchet - 10"

SKU 177728
22911 **18⁹⁹**

SKU 177768
22920 **21⁹⁹**

1/4" Drive Flexible - 6"

SKU 081301
22901 **19⁹⁹**

3/8" Drive Flexible - 11-1/2"

SKU 177730
22912 **25⁹⁹**



Flexible Head

1/2" Drive Flexible Ratchet - 17-1/2"

SKU 177769
22921 **35⁹⁹**

3/4" Drive Round Head Ratchet

SKU 133637
RA20 **24⁹⁹**



21 Piece 3/4" Drive Socket Set with Case

SKU 237647
SSH21 **139⁹⁹**



Flex Head Breaker Bars

OEM TOOLS™

3/8" Drive Breaker Bar 11 9/16 Inches

SKU 081302
22913 **17⁹⁹**

1/2" Drive 24" Flex Head Breaker Bar

SKU 750437
22923 **24⁹⁹**

1/2" Drive 18" Flex Head Breaker Bar

SKU 081303
22922 **21⁹⁹**



SOCKET SETS

OEM TOOLS™

CHOOSE THE RIGHT SET FOR THE JOB:



- Posi-Grip No-Slip®
- Off Corner Loading for Greater Torque
- Knurling Position for Best Finger Gripping
- Chamfered Ends Allow the Socket to Easily Slip Over the Bolt Head
- Deep Marking for Easy Identification

1/4" Drive Socket Sets

12 Piece - Metric
SKU 127836
22950 **18⁹⁹**

10 Piece - SAE
SKU 127786
22952 **18⁹⁹**



1/2" Drive Socket Sets

11 Piece - SAE
SKU 127812
22960 **27⁹⁹**

10 Piece - Metric
SKU 127807
22958 **27⁹⁹**



3/8" Drive Socket Sets

9 Piece Low Profile Metric
SKU 802232
22969 **19⁹⁹**

9 Piece Low Profile SAE
SKU 802226
22976 **19⁹⁹**



10 Piece Deep - Metric 11 Piece Deep - SAE

SKU 127809
22959 **34⁹⁹**

SKU 127846
22961 **35⁹⁹**



12 Piece Shallow Metric

SKU 127794
22954 **24⁹⁹**

11 Piece Shallow SAE

SKU 127798
22956 **24⁹⁹**



11 Piece Deep SAE

SKU 127803
22957 **29⁹⁹**

12 Piece Deep Metric

SKU 127797
22955 **29⁹⁹**



Triple Square

OEM TOOLS™

9 Piece Triple Square Bit Set

SKU 191052
25953 **24⁹⁹**



- Set Includes: 1/4" Drive: 37 mm: M4, M5 and M6, Length 37 mm; 3/8" Drive: M8, M10 and M12, Length 48 mm; 1/2" Drive: Tamper-Proof: M14, M16 and M18, Length 55 mm
- Bits are Made with S2 Steel Bits and Sockets are Chrome Vanadium Steel



12 Point Triple Square Bit Set

SKU 081790
LIS60750 **14⁹⁹** REG. 24.99

SAVE \$10

- Triple Square (12 Point) Bits to Fit 6, 8, 10, and 12 mm Sizes
- Fit All on 1/2 Inch Hex Drives
- Fits Some Head Bolts, Retaining Bolts, Disc Brake Calipers and Other Applications



Offer Good Through March 31, 2019 - While Supplies Last

HAND TOOLS

DID YOU KNOW?

AutoZone® carries a full line of Fel-Pro gaskets.

Contact Your AutoZone Commercial Sales Manager for Details

Torx Sets

1/4" Drive Stubby Star Drive Sets

- 3/4" Overall Length Designed for Limited Access Applications



13 Piece
SKU 447157
24293

22⁹⁹
• Sizes: T7-T50



Tamper-Proof 13 Piece

SKU 447156
24294

22⁹⁹
• Sizes: T7-T50



Master TORX® Socket Set

SKU 087309
OTC5900A **114⁹⁹**

52 Piece, Professional TORX® Socket Set

- Includes: TORX, TORX PLUS, Tamper-Resistant TORX and External TORX
- Made from Superior S2 Steel to Meet or Exceed Torque Specifications
- Includes Storage Case



7 Pc Star Socket Set

SKU 081309
24707 **6⁹⁹**

- For External Star Drive Bolts
- Sizes: E6, E7, E8, E10, E12, E14, E16



12 Piece Star Set

SKU 704328
25974 **15⁹⁹**

- Includes: 1/4" Drive: T10, T15, T20, T25, T27, T30
- 3/8" Drive: T40, T45, T47, T50, T55
- 1/2" Drive: T60

12 Piece Star Set

SKU 127870
22971 **17⁹⁹**

- Set Includes: (1/4" Drive) T8, T10, T15, T20, T25, (3/8" Drive) T27, T30, T40, T45, T47, T50, T55
- Knurling Position is Optimized for Best Finger Gripping Position
- Chamfered Ends Allow the Socket to Easily Slip Over the Bolt Head (Makes Fastener Engagement Quick and Smooth)



11 Piece Tamper Proof Star Set

SKU 127872
22972 **16⁹⁹**

Torx Socket Set

SKU 081786
LIS26750 **16⁹⁹** REG. 29.99

- Bit Sizes E-6 Through E-16
- Made of Heat-Treated Alloy Steel for Durability
- Comes in a Vinyl Holder for Easy Storage

SAVE \$13



Offer Good Through March 31, 2019 - While Supplies Last

1/4" Drive Tamper-Proof Bit Set

SKU OUTSIDE BUY/EPO
33625006 **4⁹⁹**

- Sizes: T8, T10, T15, T20, T25, T27, T30 and T40
- 1/4" Drive Socket Adapter



Available via Outside Buy/EPO. Call 1-877-298-6651 for Ordering Instructions

3/8" Drive 4 Piece Long Star Socket Set

SKU 141506
33625418 **19⁹⁹**

- Sizes: T40, T45, T50 and T55
- Great for Brake Caliper Service



Torx Bit Set - 9 Piece

SKU 081784
LIS26550 **22⁹⁹** REG. 39.99

- Sizes: T10, T15, T20, T25, T27, T30, T40, T45 and T50

SAVE \$17



Offer Good Through March 31, 2019 While Supplies Last

10 Piece Super Torx Bit Set

SKU 081319
LIS37600 **24⁹⁹** REG. 39.99

- Sizes: T10, T15, T20, T25, T27, T30, T40, T45 and T50

SAVE \$15



Offer Good Through March 31, 2019 While Supplies Last

Hex Sets

7 Piece Hex Bit Set

- Made with S2 Steel Bits
- Chamfered Ends Allow the Socket to Easily Slip Over the Bolt Head (Makes Fastener Engagement Quick and Smooth)



Metric

SKU 127883
22981 **19⁹⁹**

- Set Includes: (3/8" Dr.) 6, 8, 10 mm, (1/2" Dr.) 12, 14, 17, 19 mm

SAE

SKU 127904
22982 **19⁹⁹**

- Set Includes: (3/8" Dr.) 5/16", 3/8", (1/2" Dr.) 7/16", 1/2", 9/16", 5/8", 3/4"



12 Piece Hex Bit Set (SAE)

SKU 127905
22984 **17⁹⁹**

- Set Includes: (1/4" Dr.) 1/16", 5/64", 3/32", 7/64", 1/8" (3/8" Dr.) 9/64", 5/32", 3/16", 7/32", 1/4", 5/16", 3/8"



Master Hex Bit Set

SKU 094663
25952 **39⁹⁹**

SAE

- 1/4" Drive: 1/8", 5/32", 3/16" and 7/32"
- 3/8" Drive: 1/4", 9/32", 5/16" and 11/32"
- 1/2" Drive: 3/8", 1/2", 9/16", 3/4" and 5/8"

Metric

- 1/4" Drive: 2.5, 3, 4 and 5 mm
- 3/8" Drive: 6, 7, 8 and 9 mm
- 1/2" Drive: 10, 12, 14, 17 and 19 mm
- Comes in a Blow Mold Case



Hex Bit Set

SKU 081787
LIS13600 **16⁹⁹** REG. 29.99

- Sizes: 1/8", 5/32", 3/16", 7/32", 1/4", 5/16", 3/8"

SAVE \$13



Pliers

High Leverage Diagonal Pliers

- High Leverage Design for Gripping, Bending and Cutting Tasks



Groove Joint Pliers

- Adjustable Jaw Provides Gripping Power for Turning Irregularly Shaped Objects, Nuts and Bolts



Linesman Pliers

- Designed for Gripping, Twisting, Bending and Cutting Wire and Cable



Long Nose Pliers with Side Cutter

- For Powerful Gripping and Cutting in Hard-to-Reach Spaces



Slip Joint Pliers

- Adjustable Jaw for Gripping Small Objects and Tightening Fasteners



- Precision-Machined Jaws Provide Improved Grip
- TecReady Grip Handles Reduce User Fatigue
- Nickel Chrome Plated to Resist Rust

Part#	SKU	Type	Size	PRICE
22614	081240	High Leverage Diagonal	6-1/2"	7⁹⁹
22615	081241	High Leverage Diagonal	7-1/2"	8⁹⁹
22617	081245	Groove Joint	6"	6⁹⁹
22618	081246	Groove Joint	8"	8⁹⁹
22619	081247	Groove Joint	10"	11⁹⁹
22620	081248	Groove Joint	12"	14⁹⁹
22624	081252	Groove Joint	16"	24⁹⁹
22616	081243	Linesman	8"	14⁹⁹
22612	081237	Long Nose Pliers with Side Cutter	6"	7⁹⁹
22613	081239	Long Nose Pliers with Side Cutter	8"	8⁹⁹
22610	081235	Slip Joint	6"	6⁹⁹
22611	081236	Slip Joint	8"	7⁹⁹

7-1/2" Adjustable Angle Offset Diagonal Pliers

SKU 749916
22625 **16⁹⁹**



8-1/2" Adjustable Angle Offset Long Nose Pliers

SKU 749933
22626 **16⁹⁹**



8-1/2" Adjustable Angle Offset Linesman Pliers

SKU 749934
22627 **16⁹⁹**



Snap/Lock Ring Pliers

Lock Ring Pliers

SKU 081320
LIS44900 **15⁹⁹**

- Spread Lock Rings Commonly Found on Transmissions, Master Cylinders, Brakes and other Automotive Applications
- Specially Designed Jaws Feature Knurled Ends to Prevent Slippage



Convertible Internal and External Snap Ring Pliers

SKU 081789
LIS46000 **13⁹⁹**

- Quick Change Lever Converts from Internal to External Snap Ring Pliers
- Includes 4 Sets of Tips



Heavy Duty Snap Ring Pliers

SKU 081321
LIS49200 **39⁹⁹**

- Reversible for Internal and External Snap Rings
- Heavy Duty Construction and Larger Tips Designed for Larger Snap Rings
- Conical Tip Ends Prevent Slippage



6-1/2" Heavy Duty Snap Ring Pliers Set - 2 Piece

SKU 141502
25356 **9⁹⁹**

- Internal and External Snap Ring Pliers with Patented Tapered Tips to Securely Grip Snap Rings

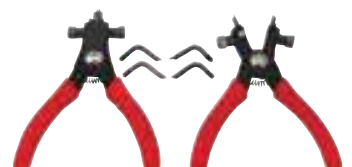

Channellock Pliers



Diagonal Cutting Pliers

- Laser Heat Treated Teeth Grip Better and Last Longer
- Knife and Anvil Style Cutting Edge

7-3/4" Curved Jaw

SKU 019260
CHA447 **24⁹⁹**

7" High Leverage

SKU 081328
CHAE337 **20⁹⁹**



10" Straight Jaw Tongue and Groove Pliers

SKU 019254
CHA430 **15⁹⁹**

- Right Angle, Laser Heat Treated Teeth Grip Better and Last Longer
- 2" Jaw Capacity
- Reinforcing Edge Minimizes Stress Breakage



6" High Leverage Long Nose Pliers

SKU 081327
CHAE326 **19⁹⁹**

- CXLT Xtreme Leverage Technology - Less Force Required to Cut Than Traditional High Leverage Pliers
- Crosshatch Pattern on Jaws for a Secure Grip
- Laser Heat-Treated Cutting Edges to Resist Wear
- Knife and Anvil Style Cutting Edge

Extended Reach Pliers

11" Long Reach Long Nose Pliers



- Constructed with Durable Heat-Treated Steel-Alloy
- Precision-Machined Jaws Provide Improved Grip
- TecReady Grip Handles Reduce User Fatigue
- Nickel Chrome Plated to Resist Rust

Straight*

SKU 081249
22621 **12⁹⁹**



45°*

SKU 081250
22622 **12⁹⁹**



90°*

SKU 081251
22623 **12⁹⁹**



*Color May Vary

Knipex Pliers



Alligator Pliers

- Plastic Coated Non-slip Handles
- Box-joint Design with Double Guide Provides Improved Stability
- Hardened Teeth for a Secure Grip



Cobra® Pliers

- Highly Stable, Box-Joint Design
- Fast Adjustment Directly on Workpiece
- Guard Prevents Fingers from Pinch points
- Gripping Surfaces with Special Hardened Teeth for Low Wear and Secure Grip



Pliers Wrench

- Functions as Pliers and a Wrench
- Smooth Jaws Won't Damage Soft Finishes
- Secure Grip, 10X Your Strength
- Push-Button Adjustment Directly on the Work Piece
- Parallel Jaws Allow Infinitely Variable Gripping of All Widths Making it Excellent for Gripping, Holding, Pressing, and Bending
- The Lever Transmission is Greater Than 10 -1 for Strong Gripping Power



3 Piece Pliers Wrench Set 7", 10", and 12"

SKU 297686
KNP002006US2 **184⁹⁹**

- Set Includes 7", 10", and 12"



3 Piece Forged Steel Universal Pliers with Alligator Pliers Set

SKU 082950
KNP002008US1 **84⁹⁹**



4 Piece Automotive Pliers Set

SKU 081317
KNP9K008094US

134⁹⁹ REG. 154.99



Offer Good Through March 31, 2019
While Supplies Last

7-1/2" Wire Rope Cutter

SKU 081316
KNP9561190 **59⁹⁹**

- For Medium Hard Wire Up to 6 mm Diameter (e.g. Bowden Cords) -- Also for Cables and Steel Rods
- Opening Spring and Locking Lever
- Special Blade Geometry Prevents the Wire Rope from Fanning Out



8" Lever Action Bolt Cutter

- Induction Hardened Cutting Edges
- Lever-Action Design Provides Optimal Cutting Performance with Minimal Effort
- Oil-hardened and Tempered Chrome Vanadium Electric Steel

Mini

SKU 081276
KNP7101200 **59⁹⁹**



Cobolt Angled Head Compact

SKU 081278
KNP7121200 **59⁹⁹**

Mini-Bolt with Notch

SKU 042478
KNP7131200 **57⁹⁹**

Diagonal Cutter

- Contains 6-1/2" and 10" Straight Head Cutters and 8" Angled Head Cutter
- Precision, Induction-Hardened Cutting Edge

3 Piece High Leverage Set

SKU 081254
KNP002005US **104⁹⁹**

6-1/2" Flush Cut

SKU 081279
KNP7201160 **37⁹⁹**

- Flush Ground Cutting Face
- Non-beveled for Flush Cutting Sprues Off Plastic Components or Soft Materials Such as Lead

8" Angled High Leverage

SKU 081283
KNP7421200 **37⁹⁹**

- Angled Cutter (12-Degree) Allows Greater Hand Clearance when Cutting on a Parallel Surface
- Lightweight, Oil-Hardened CR-V Electric Steel for Strength and Durability



8" Long Nose Pliers w/Cutter

SKU 082950
KNP2611200 **27⁹⁹**

- Half Round, Long Jaws with Serrated Gripping Surfaces
- Induction-Hardened Cutting Edges that Cut Medium-to-Hard Wire (Medium: 3.2 mm Diameter / Hard: 2.2 mm in Diameter)
- Forged, Oil-Hardened Steel
- Plastic Coated Handles

11" Hose Gripper Pliers Set - 3 Piece



SKU 094811
L311L **19⁹⁹**

- Includes Sizes: 5/16", 1/2" and 3/4"
- Constructed with Durable Drop Forged Steel
- Specialized Jaw will Securely Grip Cooling System, Fuel and Vacuum Lines—without Damaging the Hose
- Heavy Duty Double-Dipped Synthetic Grip Handles to Minimize Slippage and Reduce User Fatigue
- Chrome Plated to Resist Rust



OEMTOOLS Locking Pliers

Locking Pliers Set - 7 Piece

SKU 012622
23987 **64⁹⁹**

- Includes Curved Jaw Pliers: 4", 5", 7" and 10"; Long Nose Pliers: 4", 6" and 9"
- Constructed with Heat-Treated Alloy Steel
- Precision-Machined Jaws Feature Hardened Teeth to Provide a Sure Grip from Any Angle
- Easy Release Trigger for Improved Control



Curved Jaw

4" SKU 081256
22635 **8⁹⁹**

5" SKU 081257
22636 **9⁹⁹**

7" SKU 081261
22638 **10⁹⁹**

10" SKU 081263
22640 **12⁹⁹**



Long Nose

6-1/2" SKU 081260
22637 **9⁹⁹**

9" SKU 081262
22639 **11⁹⁹**



11" C-Clamp Locking Pliers

SKU 081265
22641 **15⁹⁹**

- Versatile Wide-Opening Jaws
- Constructed with Durable Heat-Treated Steel Alloy
- Hardened Teeth Designed to Grip from Any Angle
- Spring-Loaded Trigger Mechanism for Easy Release and Improved Control



19" Locking Chain Pliers



SKU 081267
22642 **15⁹⁹**

- For Clamping Around Irregularly Shaped Objects or Groups of Materials
- Constructed with Heat-Treated Alloy Steel
- Heavy Duty Chain Provides Added Strength
- Easy Release Trigger for Improved Control
- Nickel Chrome Plated to Resist Rust



PAIN AND BODY TOOLS

Body Repair

4 Ton Fast Action Body Repair Kit

SKU 301327
24820 **129⁹⁹**

- Long Handle Enables Low Pumping Effort
- Comes in a Blow Mold Case



10 Ton Fast Action Body Repair Kit

SKU 301328
24821 **199⁹⁹**

- Features a Faster (Double-Action) Hydraulic Pump Causing the Ram to Move with Both the Up and Down Strikes of the Arm
- Comes in a Blow Mold Case



Dent Pullers

Pull Rod Set

SKU 964653
STK20000 **44⁹⁹**

- Super Tough Alloy Steel is Precisely Heat-Treated for Maximum Strength
- Kit Contains: (4) Pull Rods and (2) Pick Rods, Stainless Steel Straight Edge, HS Split Point Drill Bit, Instruction Sheet



Super Dent Puller Set

SKU 265148
25922 **129⁹⁹**

- 12 Lbs. Hammer, Slide Hammer Shaft, Slide Hammer Handle, Deep Hook, Short Hook, Door Edge Tool, Claw, Straight Driver, Hook and Chain, Sheet Metal Screw and Holder, Nose Piece with Screw
- Comes in a Blow Mold Case



Body Tools

Fender Roller

SKU 912346
25895 **79⁹⁹** REG. \$89.99

- Great for Use on Lowered Vehicles or Vehicles with Larger Tires
- For Passenger Vehicles and Light Trucks with 4- and 5-Lug Bolt Patterns (Up to 4.75"/120 mm)
- Adjustable Roller Range (Measured from Center of Hub): 14" to 22.5"



Offer Good Through March 31, 2019 - While Supplies Last

7 Piece Body Tool Set

SKU 900813
25924 **59⁹⁹**

- Standard Bumping Hammer
- Pick and Finish Hammer
- Reversed Curve Hammer
- Shrinking Dolly
- Two Ended and Curved Dolly



Trim Clip Plier Set

SKU 447152
25947 **39⁹⁹**

- Quickly Removes Plastic Anchors That Have Center Pins without Damaging Pins or Anchors

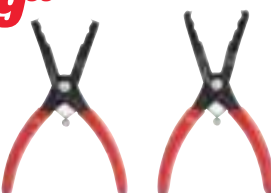

3 Piece Seam Splitter Set

SKU 265129
25337 **34⁹⁹** REG. 39.99

- Includes Straight, 30° Offset and 90° Angle Seam Splitters
- Tough Chrome Vanadium Steel
- Go Through Shafts
- Shock Dampening Grip Provides Comfort



Offer Good Through March 31, 2019 - While Supplies Last

Body Clip Pliers

SKU 094657
25923 **22⁹⁹**

- Designed to Remove Any Clip Found on Trim, Bumpers, etc.
- Steel Levers Enclosed in Plastic, Prevents Scratches

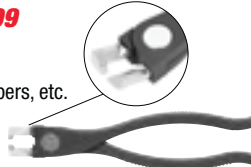

Easy Pry Tool

SKU 222857
STK21730 **19⁹⁹**

- Non-Marring Wedge
- 1" Blade with a Curved Clip End That Allows Easy Access and Removal of Plastic Bezels, Moldings, Trim and Panels without Scratching the Surface



5 Piece Fastener and Molding Remover Set

SKU 900801
25314 **19⁹⁹**

- Includes 5 Tools for Easy Removal of Fasteners, Molding, Wheel Hubs and More
- For Use on Internal and External Vehicle Molding and Trim Fasteners



Air Bag Release Tool for GM

SKU 191678
25310 **16⁹⁹**

- Fits Most GM Cars, Minivans and Light-Trucks
- Tips are Tapered to Make Removal Easier



Spray Guns

Gravity Spray Gun

SKU 738481
80-373 **54⁹⁹**

- Spray Nozzle Tip Size: 1.4 mm
- Air Consumption: 5-10 CFM @ 30-43 PSI
- Gravity Feed Cup Capacity: 20 Oz.



HVLP Spray Gun w/Gauge

SKU 738283
80-376 **54⁹⁹**

- Duralast HVLP Gravity Spray Gun Features a High Volume, Low Pressure Sprayer That Reduces Overspray to Provide Smooth, Natural Looking Results
- 20 Oz. Gravity Spray Gun Has a 1.4 mm Tip and is Great for High Volume Paint Jobs



3 Piece HVLP Spray Gun Kit

SKU 738479
80-374 **99⁹⁹**

- Duralast 3 Piece HVLP Spray Gun Kit Includes High Volume, Low Pressure Sprayers That Reduce Overspray to Provide Smooth, Natural Looking Results
- Includes: (1) 1.4 mm HVLP Spray Gun for Lighter Materials, (1) 1.7 mm HVLP Spray Gun for Heavier Materials, (2) 1,000 ml Aluminum Gravity Paint Cups, (1) Adjustable Locking Pressure Regulator with Gauge and (1) Brush



Hood Props

Telescopic Hood Support

SKU 420337
24211 **14⁹⁹**

- A Simple Turn Unlocks and Locks Support in Place
- Rubber End Caps Protect Vehicle's Finish
- 21" When Closed and Almost 48" When Fully Extended
- Compact and Easy to Store



Colors May Vary

Universal Lift Support Adjuster

SKU 191671
25307 **16⁹⁹**

- Securely Holds Gas-Charged Lift Supports in Hoods, Tailgates, Hatchbacks and Trunks
- Aluminum Body and Brass Threads Prevent Damage to the Lift Support Shaft



Hood Prop with Adapter

SKU 291352
LIS46170 **39⁹⁹**

- Includes a Support to Help Prevent Slipping
- 3 Piece Telescoping Shaft Locks in Any Position (Telescopes from 20" to 48-1/4")



Hatch Jammer Lift Gate and Hatch Holder

SKU 222853
STK17200 **69⁹⁹**

- Holds Hatch Open and Secure for Prep, Paint, Buffing and Paintless Dent Removal
- Extends to 59"



Door Tools

Door Hinge Adjuster

SKU 447144
25946 **49⁹⁹**

- Adjusts Door Hinge Position on Most Vehicles
- Two Head Adapter Works with Large and Small Latches



Door Panel and Trim Removal Set - 6 Piece

SKU 003868
25301 **39⁹⁹** REG. 44.99

- Includes: V-Notch Clip Remover, U-Notch Clip Remover, 2 Door Panel Removal Tools, C-Type Clip Removal Tool and Handle Clip Removal Tool



SAVE \$5

Offer Good Through March 31, 2019 - While Supplies Last

5 Piece Door Panel and Trim Tool Set

SKU 989263
25312 **39⁹⁹**

- Comprised of 3 Door Panels and 2 Trim Tools
- Textured, Comfortable Grips with Thumb Stop and Hanging Hole



Skin Zipper2™ Black

SKU 010125
STK21894 **39⁹⁹**

- Air Hammer Driven Door Skinning Tool for the Window Flange
- Self-Lubricating Reinforced Nylon Head
- Crimps Door Skin to the Door Shell at Window Opening



Replacement Head

SKU 010118
STK21895 **24⁹⁹**



Door Spring Tool

SKU 447118
25336 **16⁹⁹**

- Quickly and Easily Remove or Install Door Hinge Springs
- Designed for GM Cars and Light-Trucks



STORE STOCKED

Door Panel Remover

SKU 048579
25313 **9⁹⁹**

- For Easy Removal of Door Panel Clips without Damage



Window and Door Clip Remover/Installer

SKU 191679
25311 **9⁹⁹**

- Works on GM, Ford and Other Vehicles Using the Common "C" Type Clip



STORE STOCKED

Upholstery Pliers

Hog Ring Pliers Set

SKU 447162
25931 **22⁹⁹**

- Use for Upholstery Work in Most Domestic and Foreign Cars
- Includes 45° and Straight Hog Ring Pliers



Window Tint Meter

Window Tint Meter

SKU 762511
CAL63 **219⁹⁹**

- Designed to Test Windows that Roll-down or Are Fixed
- Features an Internal Light Source Guaranteeing an Accurate Measurement in All Lighting Conditions
- Measurement Range: 0-100% (+/- 2%)
- Test Time: 4 Seconds Max
- Power Source: 4 x 1.5V AAA Batteries (Not Included)



Abrasive Media

Glass Bead Coarse Media, 25 Lbs.

SKU 010136
SHA13077 **49⁹⁹**

- Ideal for Many Uses
- Prevents Surface Rust
- Paint and Body Applications
- For Use with OEMTOOLS™ 24815 Abrasive Blast Cabinet

Glass Bead Medium Grit Media, 25 Lbs.

SKU 010139
SHA13078 **49⁹⁹**





FREE OVERNIGHT SHIPPING
WITH MOST ORDERS
SEE PAGE 3 FOR DETAILS

NEW POWERTOOLS NOW IN STORE



20V MAX* Li-Ion
3/8" Drive Cordless Drill
SKU 052383 24660 **54⁹⁹**

20V MAX* Li-Ion
3/8" Drive Cordless Impact Wrench
SKU 052379 24661 **69⁹⁹**

Dual Temp Heat Gun
SKU 052387 24665 **34⁹⁹**

20V MAX* Li-Ion
1/2" Drive Cordless Impact Wrench
SKU 052380 24670 **99⁹⁹**

Heavy Duty 1/2" Drive Impact Wrench
SKU 052388 24666 **79⁹⁹**

Rotary Tool with 35 Piece Accessory Kit
SKU 052384 24664 **24⁹⁹**

4-1/2" Compact Angle Grinder
SKU 052382 24663 **29⁹⁹**

4V MAX* Li-Ion
Cordless Screwdriver
SKU 052389 24667 **24⁹⁹**

3/8" Drill
SKU 052385 24669 **29⁹⁹**



*With respect to 20V MAX, maximum initial battery voltage (measured without a workload) is 20 volts. Nominal voltage is 18.

STORE STOCKED

Specialty Tool Kits



Strut Tool / Spring Compressor Kit 91

- Allows to Quickly Compress the Strut Coil Spring
- Includes Safety Wires in Case Spring Breaks
- Forged Off-Set Metal Plates Hold Spring Securely
- Patented Design

The Powerbuilt Strut Tool spring compressor kit was designed to securely compress and hold the strut coil spring, in order to remove and install a new strut. This patented tool is heavy duty and most efficient way for completing this type of service job. The Powerbuilt patented Strut Tool is a portable alternative to the stationary shop units that most pay way too much for. The tool can be held by a standard bench vise and can be run using an impact wrench allowing you to complete this job in a matter of minutes.



Strut Coil Spring Compressor

Model 641429T
SKU #537058

200⁰⁰



22 Pc. Cooling System Pressure Test Kit 70

Model 940427T
SKU #449951

249⁹⁹

- Designed For Testing a Multitude of Cooling Systems (Caps, Radiators and Reservoirs)
- Contains Numerous Test Adapters to Fit More Than 80% of All Cars and Trucks on Road
- Allows Technician to Easily Identify Leaks in Radiator Systems
- For Expanded Coverage Use with Expansion Kit 647893



23 Pc. Ball Joint / U-Joint Service Kit 24

Model 648617T
SKU #449947

204⁹⁹

- Removes and Replaces Ball Joints and U-Joints On Many Popular Vehicles
- Heavy Duty Forged C-Clamp Frame Press Removes Even the Toughest of Ball Joints
- Works On Most Older and Late Model Domestic Vehicles
- Professional Grade Tool



4 Pc. Exhaust Pipe Kit 42

Model 648612T
SKU #536918

109⁹⁹

- For Easy and Fast Exhaust Pipe Repair
- Includes Expanders for Pipe Diameters - 1-1/2" To 3-1/2"
- Pipe Cutter Cuts Exhaust Pipes Up to 3-1/2" Diameter
- Includes a Nut Splitter Tool for Seized / Rusted Nuts



TOOL STORAGE

SAVE \$199⁹⁹ WHEN YOU PURCHASE COMBO

OEM TOOLS™

72" 26 Drawer Chest and Cabinet Combo

- Raise and Release Drawer Latches
- Gas Struts for Easy Opening
- Drawer Liners Included
- 20 Gauge Steel Shell
- 22 Gauge Steel Drawers
- Dimensions: 72" x 20" x 63" (W x D x H)

1,699⁹⁹



Features:



Locking Top and Drawers



Full Extension 100 Lbs. Capacity Slides



PU Casters



C4 Sandblasted Aluminum Trimmed Drawer Pulls

Lift Gate Service

SKU 295540
OEMLIFTGATE **80⁰⁰**

24627, 24585 or 24624	10 Drawer Top Chest	\$699.99
24628, 24586 or 24625	16 Drawer Cabinet	\$1,199.99
	Regular Price	\$1,899.98
24629, 24587 or 24626	COMBO PRICE	\$1,699.99
	SAVINGS	\$199.99

Available via Outside Buy/EPO.
Call 1-877-298-6651 for Ordering Instructions

SKU OUTSIDE BUY/EPO
24629 Blue

SKU OUTSIDE BUY/EPO
24587 Red

SKU OUTSIDE BUY/EPO
24626 Gun Metal Gray

72" 10 Drawer Top Chest

699⁹⁹

- Dimensions: 72" x 19.7" x 22.4" (W x D x H)

Lift Gate Service

SKU 295540
OEMLIFTGATE **80⁰⁰**



SKU OUTSIDE BUY/EPO
24627 Blue



SKU OUTSIDE BUY/EPO
24585 Red

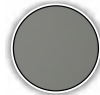

SKU OUTSIDE BUY/EPO
24624 Gun Metal Gray

Available via Outside Buy/EPO, Call 1-877-298-6651 for Ordering Instructions

72" 16 Drawer Cabinet

1,199⁹⁹

- Dimensions: 72.6" x 20" x 40" (W x D x H)

Lift Gate Service

SKU 295540
OEMLIFTGATE **80⁰⁰**



SKU OUTSIDE BUY/EPO
24628 Blue



SKU OUTSIDE BUY/EPO
24586 Red



SKU OUTSIDE BUY/EPO
24625 Gun Metal Gray

Available via Outside Buy/EPO, Call 1-877-298-6651 for Ordering Instructions

Elite Series Tool Storage

72" 11 Drawer Cabinet, with 3 Door Upper Cabinet Stainless Steel

SKU OUTSIDE BUY/EPO | 24615

1,299⁹⁹

Features:

- Dimensions: 72" x 18" x 71.5" (W x D x H)
- Upper Cabinet is 12" x 18" (H x D)
- Drawer Liners Included
- Pegboard is 18" Tall
- PVC Coated MDF Top
- Stainless Steel

Lift Gate Service

SKU 295540
OEMLIFTGATE **80⁰⁰**



Available via Outside Buy/EPO, Call 1-877-298-6651 for Ordering Instructions

OEM TOOLS™



Color Coded Flat Key Locking System



Black Aluminum Drawer Pulls



Full Extension 100 Lbs. Capacity Slides



5" x 2" Heavy Duty Casters

Service Trays

29" Portable Tear Down Trays

- Adjustable Table Height: 33-1/2" to 49-1/4"
- Total Weight Capacity: 55 Lbs.
- EVA Foam Work Surface Liners
- 29.1" x 20.1" Work Surface
- Rubber Bumper Corners

Features:



Adjustable Heights



Portable



Divider Tray with EVA Liners

SKU 850045
24616 Green
111⁹⁹



SKU 512947
24960 Black
111⁹⁹



SKU 912335
24934 Green/Black
111⁹⁹



SKU 912339
24935 Red/Black
111⁹⁹



SKU 912342
24933 Blue
111⁹⁹



OEM TOOLS™

29" Stainless Steel Tear Down Tray

SKU 819160
24634 **124⁹⁹**

- Offset Support Column Enables More of the Base to Slide Beneath the Vehicle
- 5 EVA-Lined Compartments to Organize Parts and Tools
- Adjustable Height: 38.38" to 47.63"
- Max Capacity: 165.35 Lbs. (at 38.38" Height); 110.23 Lbs. (at 47.63" Height)
- Sleek Stainless Steel Finish



• Free Delivery in 48 Continental United States • Specifications Subject to Change without Notice or Liability. Prices Do Not Include Vehicles, Installation or Optional Equipment as Shown.
• Customers Responsible for Off-Loading Equipment Upon Arrival. Ask Your Sales Rep for Details. • Leasing Terms Available.† Ask Your AutoZone® Commercial Sales Manager.

Service Carts

Professional Service Cart - 5 Drawers and 1 Tray

- Unique Raise and Release Drawer Latches to Prevent Drawers from Drifting Open
- Durable Powder Coated Finish
- Each Drawer Loading Capacity of 75 Lbs.
- Total Load Capacity of 500 Lbs.
- Dimensions: 49" L x 18" D x 37" H (with Tray Extended)

SKU 298231 24570 Green **351⁹⁹**

SKU 512950 24963 Black **351⁹⁹**



Professional Service Cart 5 Drawer and 1 Tray Features:



Locking Top and Drawers



75 Lbs. Ball Bearing Slides



Raise and Release Drawer Latches



Easy to Maneuver with (4) Swivel Casters: (2) Standard and (2) Locking



Lockable Side Has 26 Slots for Extra Storage

Hi-Impact Structural Polypropylene Service Carts - 500 Lbs. Capacity

- Stands Up to Rugged Use
- 2 Large 3" Deep Trays Keep Load Secure While Transporting
- Easy Assembly
- Heavy Duty Polypropylene
- Maximum Weight Carrying Capacity of 500 Lbs. (250 Lbs. per Shelf)
- Smooth Rolling, Non-Marring 5" Casters

Standard Service Cart

SKU 751723 24957 **124⁹⁹**

- Cart Dimensions: 33-5/8" x 17-5/16" x 40-3/8" (H x W x L)

Large Service Cart

SKU 751722 24958 **149⁹⁹**

- Cart Dimensions: 33-2/3" x 25-3/4" x 46-7/8" (H x W x L)



Convenient Organizer Tray and Cup Holder Built into Handle



Built-in Towel Rack



Smooth Rolling, Non-Marring 5" Casters

2 Fixed and 2 Swivel

Service Cart with Locking Lid and Drawer

SKU 512948 24961 **149⁹⁹**

- Easy to Maneuver with 4 Swivel Casters
- Stays Securely in Place with 2 Locking Casters
- Total Load Capacity: 350 Lbs.
- Drawer Load Capacity: 75 Lbs.
- Full Length Aluminum Drawer Handles
- Chrome Tube Legs
- Durable Powder Coated Finish
- Ball Bearing Slides
- Dimensions: 30" (H) x 18" (D) x 30" (L)



Professional Service Cart - 4 Drawers and 1 Tray

SKU 512949 24962 **287⁹⁹**

- Aluminum Trimmed Raise and Release Drawer Latches
- Durable Powder Coated Finish
- Easy to Maneuver with 4 Swivel Casters: 2 Standard and 2 Locking
- 75 Lbs. Ball Bearing Slide
- Total Load Capacity of 500 Lbs.
- Dimensions: 49" L x 18" D x 36" H (with Tray Extended)



2 Tray Service Cart

SKU 432099 24959 **119⁹⁹**

- 4" Swivel Casters: (2) Locking and (2) Standard
- Dimensions: 30"x 16" x 35.3" (W x D x H)
- Load Capacity: 350 Lbs.



3 Shelf Utility Cart

SKU 003750 24635 **135⁹⁹**

- Max Capacity: 202.8 Lbs. (92 kg)
- Tray Depth: 3"
- Dimensions: 28.75" (L) x 15.17" (W) x 30.88" (H)



(4) 4" Rubber Casters and a Sturdy Push Handle for Easy Maneuvering

Tool Bags

Wide Mouth Tool Bag with Rigid Base

SKU 814137 24543 **44⁹⁹** Reg. \$49.99

- 21 Total Tools and Parts Pockets in a Range of Sizes
- Wide Mouth Design for Easy Access to Tools
- Rugged Plastic Base
- Includes Adjustable, Detachable Shoulder Strap
- Exterior Tape Measure Clip for Convenient Access
- Constructed with Durable 1680D Polyester

Offer Good Through March 31, 2019 - While Supplies Last



Tools not included



Bucket Bag

SKU 814392 24544 **29⁹⁹**

- Tools and Parts Pockets in a Range of Sizes
- 20 Total Pockets
- 44 Total Tool Loops
- Designed for Use with 3 to 5 Gallon Buckets
- Tapered Exterior Tool Loops to Keep Tools in Place
- Wide Interior Tool Loops for Larger Tools



OEM TOOLS™



Tools and Bucket not included

Rolling Utility Bag

SKU 814174 24547 **69⁹⁹**

- Removable Interior Dividers for Customized Storage
- 19 Total Pockets
- Smooth-Rolling Casters for Easy Transport
- Rugged Plastic Base
- Includes Adjustable Shoulder Strap
- Collapsible Handle
- External Storage Net



Tools not included



Tool Tote Bag

SKU 814271 24546 **49⁹⁹**

- Tools and Parts Pockets in a Range of Sizes
- 18 Total Pockets
- 14 Total Tool Loops
- Durable Plastic Base
- Reinforced Side Panels
- Stainless Steel, Padded-Grip Handle
- Includes Adjustable Shoulder Strap
- Exterior Tape Measure Clip for Convenient Access



Tools not included



Tool Storage

Interlocking 20-Compartment Organizer

SKU 912353 22188 **14⁹⁹**

- Removable Dividers for Customized Configurations
- Durable Clear Lid for Easy Tool and Part Identification
- Interlocking Design Allows for Secured Stacking of Multiple Organizers
- Dimensions: 14.0" x 11.0" x 2.4"



Toolbox Set - 3 Piece

SKU 003799 22180 **29⁹⁹**

- Set Includes: 19" Toolbox, 12.5" Toolbox and Removable Tool Tray
- Built-in Small-Parts Organizers
- Lockable Design (Lock Not Included)
- Dimensions: 20" x 8.6" x 10"



21 Bin Storage Set

SKU 003525 22181 **34⁹⁹**

- For Storage and Organization of Small Parts, Tools and Hardware
- Wall-Mountable Design
- Constructed with High-Density Polystyrene
- Interlocking Sections for Customized Configurations
- Dimensions: 23.9" x 3.6" x 11.9"



24" 2-in-1 Toolbox and Organizer

SKU 004074 22182 **44⁹⁹**

- Features Removable Tool/Parts Organizer—Simply Pull the Front Handle to Release
- Transparent Polycarbonate Organizer Lid for Easy Tool and Part Identification
- Max Capacity: 40 Lbs.
- Dimensions: 24.0" x 12.0" x 10.0"



TOOL STORAGE

DID YOU KNOW?

AutoZone® offers ALLDATA® diagnostic software.
Contact Your AutoZone Commercial Sales Manager for Details

SAVE BIG ON TECHNICIAN SETS



SAVE \$529⁹⁹

Tool Set Savings: \$180.00
Bonus Tool Cart: \$349.99
TOTAL SAVINGS: \$529.99



OEM TOOLS™
Professional Quality Tools

Items Subject to Change

167 Piece Mechanic's Set **819⁹⁹** REG. \$999.99

SKU 533204 | 24974

This Set Includes 167 of the Most Common Tools Used by Technicians. All in a Great Looking 5 Drawer Cart

- 1/4", 3/8" and 1/2" Drive Tools
- Hand Tools
- Battery Service Tools
- Oil Change Tools

BONUS VALUE: \$349.99

5 Drawer Service Cart
SKU 512950 | 24963

With Purchase of:
167 Piece Mechanic's Set
SKU 533204 | 24974



Offer Good Through March 31, 2019 - While Supplies Last

SAVE \$649⁹⁹

Tool Set Savings: \$350.00
Bonus Tool Cart: \$299.99
TOTAL SAVINGS: \$649.99



OEM TOOLS™
Professional Quality Tools

Items Subject to Change

160 Piece Lube Tech Starter Set **999⁹⁹** REG. \$1,349.99

SKU 227302 | 24965

160 of the Most Popular Tools Used by Lube Techs

- Hand Tools
- Battery and Tire Service Tools
- Specialty Oil Filter Wrenches to Service Late Model Cars and Trucks

BONUS VALUE: \$299.99

4 Drawer Service Cart
SKU 512949 | 24962

With Purchase of:
160 Piece Lube Tech Starter Set
SKU 227302 | 24965



Offer Good Through March 31, 2019 - While Supplies Last

SAVE \$849⁹⁹

Tool Set Savings: \$500.00
Bonus Tool Cart: \$349.99
TOTAL SAVINGS: \$849.99



OEM TOOLS™
Professional Quality Tools

Items Subject to Change

312 Piece Technician's Set **1,399⁹⁹** REG. \$1,899.99

SKU 533203 | 24975

This Set Includes 312 of the Most Common Tools Used by Technicians

- 1/4", 3/8" and 1/2" Drive Tools
- Hand Tools
- Battery Service Tools
- Oil Change Tools

BONUS VALUE: \$349.99

5 Drawer Service Cart
SKU 512950 | 24963

With Purchase of:
312 Piece Technician's Set
SKU 533203 | 24975



Offer Good Through March 31, 2019 - While Supplies Last

SAVE \$949⁹⁹

Tool Set Savings: \$600.00
Bonus Tool Cart: \$349.99
TOTAL SAVINGS: \$949.99



OEM TOOLS™
Professional Quality Tools

Items Subject to Change

350 Piece Apprentice Starter Set **1,899⁹⁹** REG. \$2,499.99

SKU 227300 | 24964

This Set Includes 350 of the Most Common Tools Used by Technicians

- 1/4", 3/8" and 1/2" Drive Tools
- Air Tools
- Hand Tools
- Brake Service Tools
- Battery Service Tools
- Oil Change Tools
- Tire Tools

BONUS VALUE: \$349.99

5 Drawer Service Cart
SKU 512950 | 24963

With Purchase of:
350 Piece Apprentice Starter Set
SKU 227300 | 24964



Offer Good Through March 31, 2019 - While Supplies Last

EVERYTHING IN ITS PLACE



SLIDE RACK CABINET

RETAIL
338.41
PL-8DH-M

Slide rack cabinets are designed to hold large standard duty, heavy-duty or plastic compartment tray boxes. Heavy-duty ball bearing drawer slides for a smooth and quiet slide. Drawers extend fully to allow compartment boxes to be opened fully while in cradles. Boxes can be easily removed for transport to work areas. Drawers snap in closed position. *Locking arm available to secure contents. (*Sold separately)

SLIDE RACK CABINET
8 SLIDE RACK
20.5" W X 12.5" D X 30" H
PL-8DH-M (Shown)
Additional options available

COMPARTMENT BOXES
18" W X 12" D X 3" H
Sold separately
PL-15 (Shown)
Additional options available



RETAIL
54.86
PL-15

STORAGE BIN CABINET

4 sliding shelves equipped with ball bearing slides. Create your own bin configuration. Each shelf holds either 10 small bins (PL-SB4-2) or 5 large bins (PL-SB4-1). *Gray bin packs sold

RETAIL
305.50
PL-SB4

STORAGE BIN CABINET
41.125" W X 12.5" D X 21" H
PL-SB4

RETAIL
39.96
PL-SB4-1

LARGE BINS
7.5" W X 12" D X 3.75" H
*PL-SB4-1 - 5 Per Pack

RETAIL
45.71
PL-SB4-2

SMALL BINS
3.75" W X 12" D X 3.75" H
*PL-SB4-2 - 10 Per Pack



LOCKING UTILITY CABINETS

RETAIL
273.98
PL-UC2R

Two door utility storage cabinet can be free standing or wall mounted. Full length piano hinges and easy grip polymer handles for easy opening and closing. Inside the cabinet are (2) fully adjustable shelves that snap in and out of notches for easy adjustment. Keep items secure by attaching a padlock to the provided hasp. Cabinet is pre-drilled to coordinate with other P&L products for a complete modular storage system. Optional bases are available. Finished in a black textured powder coat. Ships fully assembled.

UTILITY CABINET
35.25" W X 12.5" D X 30" H
PL-UC2R



HEAVY DUTY BASE
35.25" W X 12.5" D X 6" H
PL-35B (Sold separately)

RETAIL
109.65
PL-35B

CHEMICAL TRAY

- Constructed from cold rolled steel
- Black texture powder coat paint
- Tray is wall mountable
- Wall mounts included

13.75" W X 5.5" D X 5.5" H
PL-CADDY

RETAIL
17.39
PL-CADDY



CONTACT YOUR COMMERCIAL SPECIALIST TO ORDER

All Items Available Through Outside Buy/EPO

 **PLATT & LABONIA**
COMPANY LLC.

APPROVED AUTOZONE® OUTSIDE BUY VENDOR



Platt & LaBonia Company LLC. An Industrial Leader Specializing In Custom Cabinets, Cases & Displays.

TOOL ORGANIZATION

Organizers

12 Piece Tool Organizer Set

SKU 765581
22189 **52⁹⁹**

- 10-Compartment Drawer Organizing Tray Features a Low Profile Design for Shallow Toolbox Drawers - Dimensions: 16" (L) x 11" (W) x 1.5" (H)
- Drawer Dividers Equipped with Adhesive Attachment for Quick Assembly
- Pliers Holder Rack and Organizer is Outfitted with Extra-Wide Spaces for Storing Up to 16 Pliers with Rubber Grips
- Organize Up to 80 Wrenches with (2) 4 Piece Wrench Holder Sets

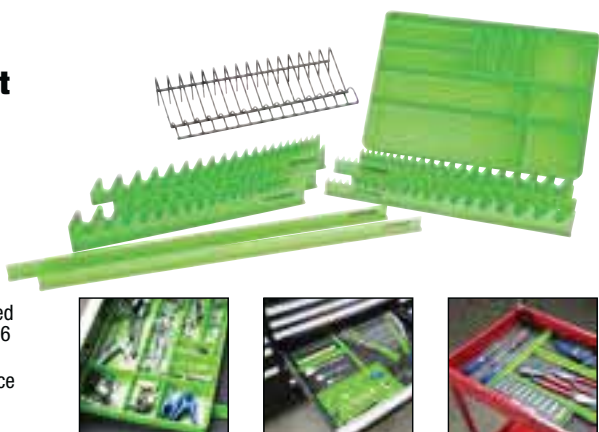

Tools Not Included

16 Piece Pliers Holder

SKU 765589
22215 **9⁹⁹**

- 16 Extra-Wide Spaces for Pliers with Rubber Grips
- Vinyl Coating for Lasting Dependability
- Dimensions: 14.0" (L) x 5.2" (W) x 2.5" (H)

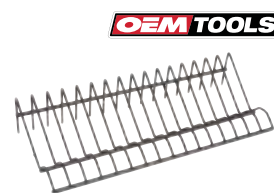

Drawer Organizer Tray

SKU 749932
22213 **11⁹⁹**

- Rolled Bottom Edges Allow Easy Removal of Small Parts
- Low Profile Fits in Shallow Toolbox Drawers
- 10-Compartment Tray; Dimensions: 16" (L) x 11" (W) x 1.5" (H)
- Stackable Design



Tools Not Included

Wrench Organizers

Pro Magnetic Wrench Organizer - Green

SKU OUTSIDE BUY/EPO
22177 **12⁹⁹**

- Organize up to 12 Wrenches
- Strong Magnets will Hold Organizer Upright at Full Capacity
- Non-marring Foam Backing

Pro Magnetic Wrench Organizer - Black

SKU OUTSIDE BUY/EPO
22176 **12⁹⁹**

- Organize up to 12 Wrenches
- Strong Magnets will Hold Organizer Upright at Full Capacity
- Non-marring Foam Backing



Strong Magnets will Hold Organizer Upright at Full Capacity

Available via Outside Buy/EPO, Call 1-877-298-6651 for Ordering Instructions

OEM TOOLS™



40 Wrench Magnetic Organizing Rails - Pair

- Sort Up to 40 Wrenches
- Magnetic Attachment for Quick Assembly on Any Ferrous Surface
- Rail Dimensions: 16.6" (L) x 1.9" (H)

Green

SKU 749850
22217 **14⁹⁹**

Black

SKU 765514
22219 **14⁹⁹**

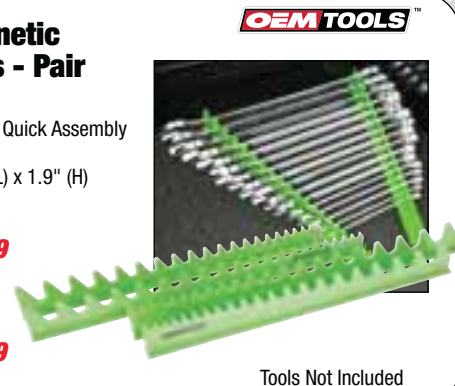

Tools Not Included

Socket Rails

OEM TOOLS™

3 Piece Black Aluminum Rail Socket Organizer Set - 1/4", 3/8", 1/2" Drive

SKU 081211
22235 **27⁹⁹**

- 3 Rails Hold Up to (16) 1/4" Drive Sockets, Up to (16) 3/8" Drive Sockets, and Up to (16) 1/2" Drive Sockets
- Each Rail is Easily Customizable with Up to (16) Detachable Studs and Dual-sided Rail
- Rails Hold Metric and SAE Sockets Upright in Tool Box/Tool Chest Drawers
- Studs Feature Ball Bearing for a Secure Fit
- Dimensions: 17-1/4" (L), 7/8" (W), 1" (H)

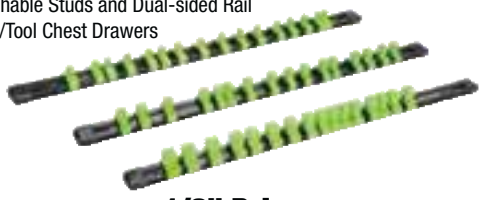

Black

1/4" Drive

SKU 749859
22198 **9⁹⁹**

3/8" Drive

SKU 749863
22197 **9⁹⁹**

1/2" Drive

SKU 749845
22196 **9⁹⁹**

3 Piece Matte Aluminum Rail Socket Organizer Set - 1/4", 3/8", 1/2" Drive

SKU OUTSIDE BUY/EPO
22236 **27⁹⁹**

Available via Outside Buy/EPO, Call 1-877-298-6651 for Ordering Instructions



Tools Not Included

Matte Silver

1/4" Drive

SKU 749929
22202 **9⁹⁹**

3/8" Drive

SKU 749843
22201 **9⁹⁹**

1/2" Drive

SKU 749852
22200 **9⁹⁹**

Socket Rail Magnetic Clips - 2 Piece

SKU 081206
22190 **7⁹⁹**

- Magnetic Attachments for Socket Rails: 22196, 22197, 22198, 22200, 22201 and 22202



Socket Trays

OEM TOOLS™

6 Piece Socket Tray Set - Metric and SAE

SKU 949573
22233 **39⁹⁹**

- Metric Socket Range: 4mm to 15mm (1/4" Drive), 6mm to 20mm (3/8" Drive), 10mm to 27mm (1/2" Drive)
- SAE Socket Range: 1/8" to 5/8" (1/4" Drive), 1/4" to 1" (3/8" Drive), 3/8" to 1-1/4" (1/2" Drive)

3 Piece Socket Tray Set - SAE

SKU 749921
22207 **22⁹⁹**

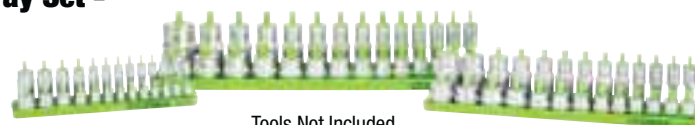

Tools Not Included

SAE - Green

1/4" Drive

SKU 749854
22204 **8⁹⁹**

- Socket Range: 1/8" to 5/8"

3/8" Drive

SKU 749918
22205 **9⁹⁹**

- Socket Range: 1/4" to 1"

1/2" Drive

SKU 749931
22206 **12⁹⁹**

- Socket Range: 3/8" to 1-1/4"

3 Piece Socket Tray Set - Metric

SKU 749937
22211 **22⁹⁹**



Tools Not Included

Metric - Black

1/4" Drive

SKU 749851
22208 **8⁹⁹**

- Socket Range: 4 mm to 15 mm

3/8" Drive

SKU 749826
22209 **9⁹⁹**

- Socket Range: 6 mm to 20 mm

1/2" Drive

SKU 749924
22210 **12⁹⁹**

- Socket Range: 10 mm to 27 mm

Pro Tool Organization

Professional Socket Trays

8 Piece Set

SKU 606549
22388 **114⁹⁹**

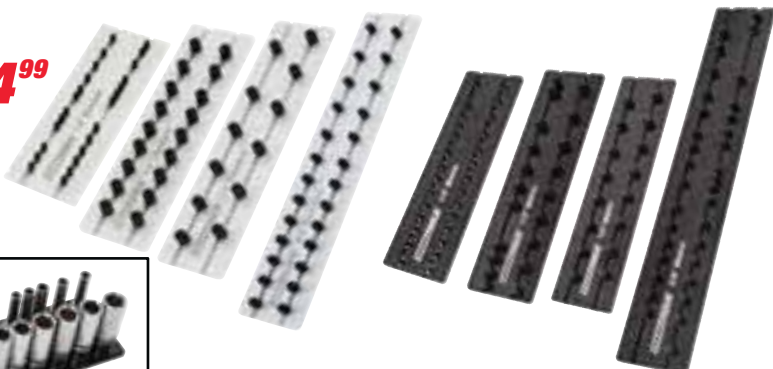

- 8 Trays with Anodized Black and Aluminum Finish for Drive Size 1/4", 3/8", and 1/2" Sockets
- Rubber Non-Slip Feet Protect Your Work Bench from Scratches
- Billet Aluminum Construction



Adjustable Studs for Custom Socket Locations

Matte Aluminum 4 Piece Set

SKU 606548
22387 **58⁹⁹**

Black Aluminum 4 Piece Set

SKU 606547
22383 **58⁹⁹**



Tools Not Included

80 Piece Socket Rail Tray

- Accommodates (80) Sockets: (20) 1/4" Drive, (30) 3/8" Drive, (30) 1/2" Drive
- Detachable Clips Feature Ball Bearing for Secure Fit
- Convenient Carrying Handle for Easy Transport
- Compatible with Metric and SAE Sockets
- Dimensions: 17.5" (L) x 6.0" (W) x 1.0" (H)

Green

SKU 749917
22203 **24⁹⁹**



Tools Not Included

Black

SKU 764983
22199 **24⁹⁹**



Tools Not Included

Magnetic Socket Tray Rack

SKU 082922
22389 **26⁹⁹**

- Magnetic Socket Tray with Customizable Stud Configurations for Easy Storage and Organization
- Store Up to 36 Total Sockets - 1/4", 3/8" and 1/2" Drive
- Removable Back Panel Allows Magnets to Adhere to any Ferrous Surface



Tools Not Included

Magnetic Tool Holder

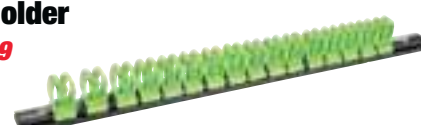

SKU 749848
22212 **19⁹⁹**

- 18" Rail with 16 Detachable Clips for Customization
- Multi-Purpose Clips for a Variety of Tools
- Powerful Magnet for Secure Hold Under Load
- Foam Magnet-Shield to Protect Paint Finishes from Scratching

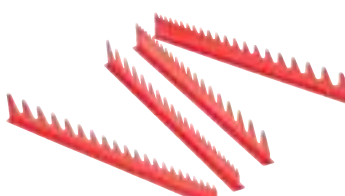

Tools Not Included

<p>ERNST</p> <p>11 Tool Gripper Stubby Wrench Organizer - Red SKU 543261 ERN5076 5⁹⁹</p> <ul style="list-style-type: none"> • Can Hang on Walls, Pegboard, or Side of a Mobile Tool Cart Using the Vertical Cart Mount Kit  <p>7 Tool Gripper Wrench Organizer - Red SKU 543262 ERN5080 4⁹⁹</p> 	<p>8 Inch Magnetic Socket Organizer with Twist Lock Clips 1/4" - Blue SKU 543253 ERN8407M 14⁹⁹</p>  <p>3/8" - Blue SKU 543254 ERN8408M 14⁹⁹</p> <p>1/2" - Blue SKU 543255 ERN8409M 14⁹⁹</p>	<p>8 Inch Magnetic Socket Organizer with Twist Lock Clips 1/4" - Red SKU 543247 ERN8410M 14⁹⁹</p>  <p>3/8" - Red SKU 543248 ERN8411M 14⁹⁹</p> <p>1/2" - Red SKU 543251 ERN8412M 14⁹⁹</p>	<p>ERNST</p> <p>Socket Boss 3 Rail Socket Tray</p> <p>Red SKU 255105 ERN8450 22⁹⁹</p>  <p>Blue SKU 255120 ERN8451 22⁹⁹</p> 
--	---	---	---

<p>40 Wrench Organizer Kit</p> <ul style="list-style-type: none"> • Graduated Teeth Provide Maximum Wrench Storage • Trims Easily for a Custom Fit • Made in the USA 	<p>Red - Magnetic SKU 543275 ERN6014M 16⁹⁹</p> <p>Red - Nonmagnetic SKU 543273 ERN6014 9⁹⁹</p> 	<p>Black - Magnetic SKU 543276 ERN6015M 16⁹⁹</p> <p>Black - Nonmagnetic SKU 543274 ERN6015 9⁹⁹</p> 
--	--	---

<p>20 Wrench Rail Set with Magnetic Back- Black SKU 543271 ERN6013M 13⁹⁹</p> 	<p>20 Screwdriver Rail Set - Black SKU 543265 ERN6011 7⁹⁹</p> 	<p>10.5 Inch x 10.5 Inch 10 Compartment Organizer Tray - Black SKU 543252 ERN5021 5⁹⁹</p> 	<p>3 Compartment Organizer Tray - Red SKU 543278 ERN5020 5⁹⁹</p> 
--	--	---	--

EZRRED Wrench Racs

<p>15 Piece WrenchRac</p> <ul style="list-style-type: none"> • Sliding Magnetic Posts Can Hold a Variety of Wrench Sizes and Types • Non-Scratch Heavy Duty Aluminum Rail • Magnetic End Caps That Adhere to Any Steel Surface 	<p>Red SKU 221560 EZRWR1500 22⁹⁹</p>  <p>Tools Not Included</p>	<p>Blue SKU 221598 EZRWR1500B 22⁹⁹</p>  <p>Tools Not Included</p>	<p>Green SKU 203945 EZRWR1500G 22⁹⁹</p>  <p>Tools Not Included</p>
--	--	---	---



Tools Go Where You Go with Tear Down Trays

The OEMTOOLS™ Tear Down Tray has powder-coated, all-steel construction for durability and a work surface with EVA foam liner to keep tools in place when tray is moving. It features rubber-lined corners to prevent scratching or denting vehicles and other objects in the work area.



For More Details Go to Page 106

SHOP SUPPLIES

Shop Stools

Buy 2 and SAVE

One Swivel Shop Stool

SKU 512951 24910 **62⁹⁹**
 • Swivel Seat
 • 30.5" High x 14" Across



Color May Vary

Two Swivel Shop Stools

SKU 432326 24910TWO **99⁹⁹**

Buy 2 and SAVE \$50.99

Adjustable Hydraulic Shop Stool with Backrest (Green)

SKU 758782 24931 **124⁹⁹**
 • Ideal for Shop or Garage Use
 • Durable, Vinyl-Padded Swivel Seat and Backrest for Comfortable Support
 • Adjustable Height: 29" to 33"
 • Rugged Matte Black Finish Prevents Wear from Corrosion
 • Easy to Assemble



Buy 2 and SAVE \$54.99

One Adjustable Hydraulic Stool (Black)

SKU 512945 24911 **124⁹⁹** Color May Vary

Two Adjustable Hydraulic Stools (Black)

SKU 362969 24911TWO **194⁹⁹** Color May Vary

Adjustable Hydraulic Stool That Raises from 28" to 32.5"



Orange
 SKU 298183 24914 **89⁹⁹**

Green
 SKU 751712 24912 **89⁹⁹**

Green
 Two Swivel Shop Stools
 SKU 749837 24912TWO **99⁹⁹**

Truck Step

Adjustable Tire Step

SKU 818571 24913 **30⁹⁹**
 • Fits Both Front and Rear 9" to 13" Wide Tires
 • Powder Coat Finish
 • Designed for SUVs, Motor Homes and Light-Duty Trucks
 • Heavily Textured Non-Slip Step for Safety
 • Adjustable Rubber Bumpers Protect Your Wheels and Ensure the Step is Sturdy and Level
 • Easy to Adjust
 • Weight Capacity: 300 Lbs.



Work Stand

Pro Step Adjustable Work Stand

SKU 222856 24911 **189⁹⁹** REG. \$209.99
 • 500 Lbs. Capacity
 • 32" x 16"
 • Height Adjustable from 6-1/2" to 22-1/2"



Offer Good Through March 31, 2019 While Supplies Last

Shop Supplies

Paper Floor Mats

SKU 186484 24911 **49⁹⁹**
 • Coated Paper "Footprint" Style
 • Box of 500
 • 17" x 22"



Work Ticket Holder (25/Box)

SKU 698887 24911 **44⁹⁹**
 • Durable Brass Grommet Increases Strength
 • Accommodates Most Pre-Printed and Computer Generated Forms
 • Dimensions: 14.5" x 10.5"



Value Coated Paper Floor Mats (500/Case)

SKU 262539 24911 **51⁹⁹**
 • 17" x 19" Plain Paper Mat
 • Reusable
 • Disposable
 • Dispenses Off of Roll



White Plastic Key Tag Write On (1,000 Count)

SKU 262547 24911 **22⁹⁹**
 • Self Locking Plastic Key Tags Help Secure Keys
 • Write On
 • 1,000 Count

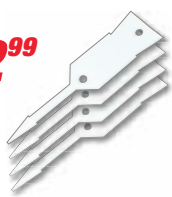

Value Seat Cover (Disposable) (500/Roll)

SKU 186487 24911 **69⁹⁹**
 (250/Roll) **49⁹⁹**
 SKU 262537 24911 **49⁹⁹**
 SNGMFGP994314



Steering Wheel Cover (500/Box)

SKU 186485 24911 **59⁹⁹**
 (250/Box) **39⁹⁹**
 SKU 262538 24911 **39⁹⁹**
 SNGMFGP994336



Startup Kit (Dispenser and Product)

SKU 262544 24911 **379⁹⁹**
 SNGMFKP994376
 • 250 Seat Covers, 500 Plastic Floor Mats, 500 Parts Bags, 250 Steering Wheel Covers, 100 Tire Bags and 250 Paper Floor Mats



Plastic Floor Mats

SKU 186488 24911 **59⁹⁹**
 SNGMFGP994302
 • Slip-N-Grip® Plastic Disposable Mat
 • Box of 500
 • Roll 16.5" x 21"



Adhesive Floor Mats (175/Roll)

SKU 280375 24911 **99⁹⁹**
 SNGMFGP994438
 • Self Adhesive, 3 mil Protective Film Keeps Carpet Protected



Oil Change Labels

Thermal Oil Change Sticker Printer

SKU 526488 24911 **699⁹⁹**
 SNGFKGX00106
 • Kit Includes: Printer, Keyboard, Power Cord/Adapter, (1) Ink Ribbon and (2) Rolls of 500 Generic Static Cling Labels



Static Cling Refill Kit

SKU 291380 24911 **119⁹⁹**
 SNGMFGO16501
 • 2 Rolls of Labels • 1 Replacement Ribbon

Hand Cleaner

World's Best Hand Cleaner

• All Natural, Concentrated, Solvent Free Cleansing Formula
 • Unique Skin Conditioning System Leaves Hands Feeling Smoother, While Fibril Scrubbers Deep Clean Even the Toughest Dirt
 • Cherry Fragrance Leaves Hands Smelling Great
 • 100% Biodegradable



24292

Starter Kit with BONUS Dispenser

SKU 972773 24292 **39⁹⁹**
 • Kit Includes Wall-Mount Dispenser and 4,000 mL of Cherry Fragrance Cleaner



24291

4000 mL Refill Bottle

SKU 972772 24291 **34⁹⁹**

Fender Covers

Fender Cover

SKU 818712 24902 **24⁹⁹**
 • Heavy Gauge Vinyl
 • Wipes Clean
 • Sewn-in Tool Ridge
 • 27" x 34"
 • Won't Mar or Scratch Surface



STORE STOCKED

Soft Fleece Fender Cover

SKU 751711 24899 **24⁹⁹**
 • Soft Fleece Fender Cover to Prevent Paint Damage
 • Two Super Powerful Corner Magnets for Securing the Cover in Place
 • Magnets are Removable to Wash the Cover
 • Large 42 In. x 24 In. Size for Cars, Trucks, and SUVs



Fender Cover

SKU 965832 24900 **24⁹⁹**
 • Heavy Gauge Vinyl
 • Wipes Clean
 • 27" x 34"



Vehicle Not Included

Non-Slip Fender Cover

SKU 447120 80-205 **24⁹⁹**
 • Heavy Gauge Vinyl Wipes Clean
 • 24" x 36"



Trays

10" x 11" Magnetic Tray

SKU 965835 25119 **30⁹⁹**
 • OEMTOOLS™ Magnetic Trays are Strong and Durable to Collect Small Parts, Fasteners and Tools
 • Four Powerful Magnets with Protective Rubber Coating to Resist Scratching
 • Ideal for Holding Small Parts and Tools
 • Heavy Duty Stainless Steel



Tools Not Included

10" Magnetic Nut Tray

SKU 434570 25115 **24⁹⁹**
 GRI67435
 • Teflon® Coated Steel Resists Scratches and Corrosion
 • 3 Rubber-Covered Magnets Keep the Tray and Parts Securely in Place
 • 10" Wide x 2" Depth



Magnetic Nut Cup

SKU 796066 25114 **17⁹⁹**
 • No More Crawling Around on the Ground Looking for a Fallen Fastener or Nut
 • Magnetic Cups Hold Nuts, Bolts, Parts and Screws Securely Until You Need Them
 • Strong Magnets Attach the Cups Securely to Flat Metal Surfaces



Magnetic Nut Cups, 2 Pack

SKU 592211 25115 **24⁹⁹** REG. \$29.99
 • Matching Magnetic Cups Come in a Pair and are Shipped in a Handsome Display Box



Offer Good Through March 31, 2019 - While Supplies Last

Magnetic Paper Towel Holder

Magnetic Paper Towel Holder

SKU 280376 24952 **17⁹⁹**
 • 2 Piece Design Adjusts to Fit Different Size Rolls
 • 3.1" from Base to Paper Towel Holder Ring
 • Durable Black Matte Finish with 3 Heavy Duty Magnets Will Mount on Any Metal Surface
 • Rubber-faced Magnets Won't Scratch Metal Surfaces



Towel Roll not Included



FREE OVERNIGHT SHIPPING
WITH MOST ORDERS
SEE PAGE 3 FOR DETAILS

Creeper Seats: For All Day Comfort and Mobility



Workshop Creeper Seat with 2 Drawers

- Vinyl Foam Padded Seat for Maximum Comfort
- 2 Sliding Drawers to Store Parts
- Under Seat Storage for Tools, Parts & Accessories
- Can Holder for 3 Cans
- Smooth Rolling Swivel Castor Wheels
- Weight Capacity: 280 Lbs.



2 Inch Smooth Rolling Caster Wheels



Can Holder for 3 Cans



- | | | | | | | |
|--|---|--|--|---|---|--|
| White
SKU 542429
24995 99⁹⁹ | Yellow
SKU 542931
24999 99⁹⁹ | Red
SKU 542826
24998 99⁹⁹ | Green
SKU 542354
24993 99⁹⁹ | Blue
SKU 542531
24996 99⁹⁹ | Orange
SKU 542617
24997 99⁹⁹ | Black
SKU 542385
24994 99⁹⁹ |
|--|---|--|--|---|---|--|

Shop Seats and Creepers

Professional 41" 6 Wheel Creeper

- SKU 125749
24970 **99⁹⁹**
- 3D Streamline Design for Shoulder Clearance
 - 6 Heavy Duty TPU Casters
 - Low Ground Clearance Allows for Greater Mobility
 - 4 Tool Storage Trays
 - Weight Capacity 300 Lbs.



Tools Not Included

Tractor Seat Creeper

- SKU 301771
24953 **117⁹⁹**
- Tractor Style Shop Seat
 - 4 Durable Swivel Casters
 - Parts Tray



Cushioned Creeper Seat with Tool Tray

- SKU 757019
24948 **39⁹⁹**
- Tool Tray Dimensions: 11-1/2" x 12-1/2"
 - Cushioned Seat
 - 4 Swivel, Oil-Resistant Wheels
 - Weight Capacity: 330 Lbs.



Anti Fatigue Kneeling Pad

- SKU 125753
24971 **24⁹⁹**
- EVA Construction is Resistant to Oil and Other Petroleum Products
 - Great for Kneeling in Severe Conditions Such as Steel, Concrete, Grating and Gravel
 - 18" x 8" x 1"



Racing Body Board EVA Foam Creeper

- SKU 125754
24972 **39⁹⁹**
- EVA Construction is Water, Chemical and Impact Resistant
 - Includes Handle and Two Tool Compartment Cutouts
 - Great for Both Garage and Outdoors
 - Lightweight Construction is Portable and Easy to Stow
 - 41" x 18" x 1"



44" Aluminum Creeper

- SKU 237641
71004 **123⁹⁹**
- Lightweight and Strong Aluminum
 - Adjustable Headrest



Hardware Kits

34 Piece Hose Clamp Assortment

- SKU 271201
68137 **9⁹⁹**
- Includes Sizes: 5/8" - 1-1/4"



96 Piece Mini Fuse Kit

- SKU 271169
68148 **16⁹⁹**
- Includes: Mini Fuses 3A - 30A



96 Piece ATO Fuse Assortment

- SKU 271172
68149 **16⁹⁹**
- Includes: ATO Fuses 3A - 30A



200 Piece Spring Assortment

- SKU 271195
68140 **9⁹⁹**
- Includes 20 Popular Sizes from 7/32" x 11/16" to 5/16" x 1-1/4"



300 Piece E-Clip Assortment

- SKU 271188
68145 **9⁹⁹**
- Includes: 1/16" - 7/8"



80 Piece Vacuum Cap Assortment

- SKU 271197
68129 **11⁹⁹**
- Includes Sizes: 3/16" - 3/8"



555 Piece Cotter Pin Assortment

- SKU 271180
68120 **12⁹⁹**
- Includes 6 Popular Sizes from 1/16" x 1" to 5/32" x 2-1/2"



500 Piece Aluminum Rivet Assortment

- SKU 271150
68109 **11⁹⁹**
- Includes: 1/8" and 3/16" Rivets 1/4", 5/16" and 3/8" Long



24 Piece Maxi Fuse Assortment

- SKU 271152
68146 **19⁹⁹**
- Includes: Maxi Fuses 20A - 100A



158 Piece Wire Connector Assortment

- SKU 271200
68131 **10⁹⁹**
- Popular Sizes for Joining 2, 3 or 4 Wires #22 - #10



240 Piece SAE Bolt, Nut and Washer Kit

- SKU 271179
68106 **10⁹⁹**
- Includes 20 Popular Sizes and Lengths from #8 to 3/8"



240 Piece Metric Bolt, Nut and Washer Kit

- SKU 271149
68107 **10⁹⁹**
- Includes Popular Sizes and Lengths: M4 - M10



407 Piece Universal O-Ring Set (SAE)

- SKU 546661 | 68168 **19⁹⁹**
- Inside Diameters from 1/8" to 2"

419 Piece Universal O-Ring Set (Metric)

- SKU 546659 | 68167 **19⁹⁹**
- Inside Diameters from 3 mm to 50 mm



110 Piece Metric Copper Washer Assortment

- SKU 271176
68117 **12⁹⁹**
- Includes Popular Sizes: M6 - M16



555 Piece Stainless Cotter Pin Assortment

- SKU 271183
68121 **14⁹⁹**
- Includes 6 Popular Sizes from 1/16" x 1" to 5/32" x 2-1/2"



SHOP HEATERS, COOLING AND FANS

Shop Heaters

1500W 120V Shop Heater
SKU 814316 24823 **99⁹⁹**

- Stainless Steel Heating Element
- Adjustable Thermostat
- Auto-reset Overheat Protection
- Durable, Rust Resistant Powder Coated Finish
- Fan Mode
- Carry Handle and 6' Cord
- 120V Input



4800W 240V Wall Mount Heater

SKU 814134 24824 **159⁹⁹**

- Stainless Steel Heating Element
- Wireless Remote Control
- Auto-Reset Overheat Protection
- Adjustable Thermostat with LED Display
- Timer Mode 1-9 Hours
- Fan Only Mode
- Durable, Rust Resistant Powder Coated Finish
- Handle with Built-in Cord Storage
- Includes Wall/Ceiling Mounting Bracket
- 208-240V Input Power



Wireless Remote Control Included

40-60K BTU Liquid Propane Heater

SKU 814143 24822 **169⁹⁹**

- Adjustable Heating Output from 40-60K BTU
- Built-in Overheating Protection
- 115V AC Power Input for Multipurpose Use
- Continuous Ignition
- Adjustable Angle Base
- Operates on Liquid Propane Gas
- Includes Regulator and 10' Hose
- Includes Wall/Ceiling Mounting Bracket
- 208-240V Input Power



OEM TOOLS™

Barrel Fans

42" Belt Driven Barrel Fan
SKU 688203 24876 **449⁹⁹**

- Versatile 42" Barrel Fan
- 2-Speed Belt Driven Motor
- 15,800 CFM
- 6' UL Listed Cord



42" Direct Drive Barrel Fan

SKU 344969 24879 **415⁹⁹**

- 42" Barrel Fan Provides 12,718 CFM
- 2-Speed, Direct Drive Motor Gives Operator Control of Airflow Volume
- 3 Aerodynamic Aluminum Blades Produce Optimal Airflow Output



Color May Vary

24" Tilt Barrel Fan

SKU 688216 24874 **189⁹⁹**

- 24" Tilting Barrel Fan
- 180° Tilt
- 2-Speed High-Efficiency Motor
- 3 Aluminum Fan Blades
- 9,230 CFM
- 6' UL Listed Cord



36" Tilt Barrel Fan

SKU 688217 24875 **329⁹⁹**



OEM TOOLS™

Workspace Fans

12" Tilting Workspace Fans Black
SKU 949568 24891 **49⁹⁹**

- 12" Tilt Fan Produces 1,450 CFM
- 3-Speed Motor and Tilt Function Allows Operator to Control Airflow Volume and Direction
- Output Power: 1/60 HP
- SPL: 57dB
- Fan Dimensions: 15.38"(L) x 16.50"(W) x 7.00"(D)

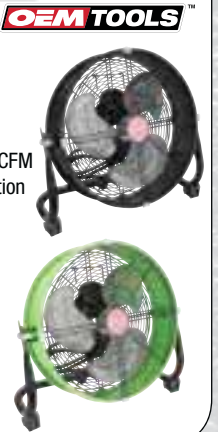

Green
SKU 949555 24892 **49⁹⁹**

Wall Mount Fans

OEM TOOLS™

Oscillating Wall Mount Fan

24"
SKU 592383 24883 **149⁹⁹**

- 6,500 CFM of Airflow
- Oscillates 180°
- Complete Metal Structure

30"
SKU 592385 24884 **179⁹⁹**

- 9,500 CFM of Airflow

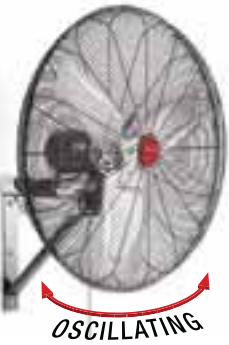

OSCILLATING

Heavy Duty Workstation Fan

18"
SKU 949579 24895 **89⁹⁹**

- Easily Assembled and Wall Mounted
- Powerful 3-Speed Motor Produces 3,850 CFM
- Tilting Mechanism Allows 360° Rotation
- Output Power: 1/20 HP
- SPL: 63dB



SAVE \$20

360° ROTATES

24"
SKU 949557 24896 **119⁹⁹** REG. 139.99

Offer Good Through March 31, 2019 - While Supplies Last

Outdoor Fans

OEM TOOLS™

24" Outdoor Oscillating Wall Mount Fan

SKU 949553 24893 **189⁹⁹**

- Easily Assembled and Wall Mounted
- Powerful 3-Speed Motor Produces 6,800 CFM
- Oscillating Function Provides Effective Air Circulation
- IP44 Water Resistance Rating for Outdoor Use
- Output Power: 1/7 HP
- SPL: 74dB

30" Outdoor Oscillating Wall Mount Fan

SKU 949582 24894 **209⁹⁹**

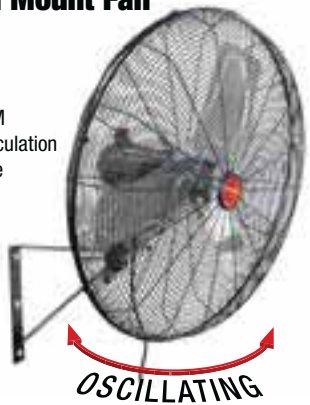

OSCILLATING

Pedestal Fans

20" Pedestal Fan
SKU 688199 24872 **79⁹⁹** REG. 89.99

- 20" Orbital Fan
- 3-Speed High-Efficiency Motor
- 3 Aluminum Fan Blades
- 4,200 CFM
- 6' UL Listed Cord

Offer Good Through March 31, 2019 While Supplies Last



SAVE \$10

360° ROTATES

30" Pedestal Fan

SKU 688201 24873 **169⁹⁹** REG. 189.99

- 30" Pedestal Fan
- 3-Speed High-Efficiency Motor
- 6' UL Listed Cord
- 7,250 CFM

Offer Good Through March 31, 2019 While Supplies Last



SAVE \$20

24" Rolling Tilt Fan

SKU 592212 24880 **139⁹⁹** REG. 149.99

- 8,600 CFM of Airflow
- 4" Rear Wheels for Easy Mobility

Offer Good Through March 31, 2019 While Supplies Last



SAVE \$10

360° ROTATES

20" Oscillating Pedestal Fan

SKU 688197 24871 **89⁹⁹** REG. 99.99

- 20" Pedestal Fan
- 3-Speed Motor
- 5 Aluminum Blades
- 4,200 CFM
- 6' UL Listed Cord

Offer Good Through March 31, 2019 While Supplies Last



SAVE \$10

OSCILLATING

30" Oscillating Pedestal Fan

SKU 592248 24885 **179⁹⁹** REG. 199.99

Offer Good Through March 31, 2019 While Supplies Last



SAVE \$20

Orbital Floor/Wall Mount Fans

OEM TOOLS™

20" Orbital Drum Fan

SKU 592210 24882 **84⁹⁹** REG. 99.99

- 5,100 CFM of Airflow
- Pivotal Ring for Rotating Vertically and Horizontally



SAVE \$15

Wall Mountable

Offer Good Through March 31, 2019 While Supplies Last

Floor Fans

18" Floor Fan

SKU 592201 24881 **59⁹⁹** REG. 69.99

- V-Shaped Base with Pivoting Arms So the Fan Can Be Tilted
- Rear Handle for Easy Transportation
- 3 Aluminum Blades Produce 4,500 CFM
- 3-Speed, 1.05 Amp Motor
- 5' UL Listed Power Cord

20" Floor Fan

SKU 688200 24870 **74⁹⁹**

Offer Good Through March 31, 2019 While Supplies Last

SAVE \$10

Offer Good Through March 31, 2019 While Supplies Last



180° TILT

Blower Fans

Portable Mechanic's Fan

SKU 850066 24878 **119⁹⁹**

- For Indoor or Outdoor Use
- 4 Position Feet
- 3-Speed Switch
- 1,200 CFM
- (2) 11 Amp Grounded Receptacles with Over Current Protection



12" Cylinder Blower Fan

SKU 949566 24897 **179⁹⁹**

- Designed to Efficiently Ventilate or Extract Air in Areas with Limited Access
- Powerful 2-Speed Motor Provides 3,100 CFM
- IP44 Water Resistance Rating for Outdoor Use
- Output Power: 1/3 HP
- SPL: 85dB
- For Use with OEMTOOLS™ 24898 16' Duct Attachment



16' Duct Attachment for 12" Blower Fan

SKU 949559 24898 **79⁹⁹**

- Fits Other 12" Blower Fans with Cylinders Less Than 13.5" in Diameter
- Integrated D-Rings to Suspend Hose from Wall or Ceiling



12" Cylinder Blower Fan with 16' Duct Attachment

SKU 949554 24929 **249⁹⁹**



SAVE \$9.99 When You Buy the Set

SAFETY SUPPLIES

877-AZTool1
877-298-6651
Hablamos Español
AZtool1.com

Safety Reader Glasses

OEM TOOLS™

- Multifocal Technology Allows You to See at Various Distances
- High-Impact Lenses Provide Safety from Dirt and Debris
- ANSI/ISEA Z87.1-2015 Compliant
- 99.9% UV Protection
- Fully Adjustable Stems Provide a Custom Fit
- Flexible Rubber Ear Piece to Keep Safety Glasses in Place

24⁹⁹

+1.50
SKU 752076 | 26023

+3.0
SKU 752086 | 26026

+2.0
SKU 752077 | 26024

+3.5
SKU 750496 | 26027

+2.50
SKU 752078 | 26025



Safety Glasses

NSX Turbo Safety Glasses (Box of 12)

- High Impact Clear Polycarbonate Lens
- 99.9% UV Protection
- Lightweight, Wrap Around Shade Lens

Clear Lens
SKU 301767
SAS5330PK

24⁹⁹

Yellow Lens
SKU 462984
SAS5332PK

24⁹⁹

Shade Lens
SKU 462983
SAS5331PK

24⁹⁹



Camo LED Glasses

- Adjustable Ultra-Bright Built-in LED Lights
- High-Impact Polycarbonate Lens
- 99.9% UV Protection
- Anti-Fog and Scratch Resistant Lens Coating
- LR44 Batteries Included
- ANSI/ISEA Z87.1-2015 Compliant

Green
SKU 010115
SAS5421

19⁹⁹

Tan
SKU 010113
SAS5422

19⁹⁹



First Aid Kits

10-Person First Aid Kit

SKU 000006
SAS6010

- Multi-Use First Aid Kit Designed for Use in the Work Place for Up to 10 Employee



25-Person First-Aid Kit

SKU 765588
SAS6025W



100-Person First-Aid Kit

SKU 765585
SAS609901

Back Belts

Deluxe Back Support Belt

- Made of Lightweight, Cool, Washable Nylon
- Six Fully Enclosed Steel Springs Stay Flexible for Contoured Support
- Tapered Design Allows a Full Range of Body Motion While Maintaining Proper Support

19⁹⁹



Small
SKU 803153 | SAS7161

Medium
SKU 803156 | SAS7162

Large
SKU 803161 | SAS7163

X-Large
SKU 803151 | SAS7164

XX-Large
SKU 803152 | SAS7165

Safety Supplies

4-in-1 Emergency Tool

SKU 526510
24505

14⁹⁹

- Includes Emergency Glass Breaker Hammer, Seat Belt Cutter, Bright Flashlight and Digital Tire Gauge
- Store This Compact Tool in Your Glove Compartment
- Great Gift for a Friend or Loved One
- Uses 2 AAA Batteries (Not Included)



Faceshield Clear

SKU 972271
SAS5140

19⁹⁹

- High-Impact Polycarbonate Lens
- Pre-Injected Curved Lens
- Locking Adjustable Headpiece



Masks

Nuisance Dust Mask (Box of 50)

SKU 526952
SAS2985

16⁹⁹

- One-Size-Fits-All Mask That Reduces Irritating Effects from Non-Toxic Particles



Bandit N95 Half Mask Respirator

- Form Fitting and Can Be Worn for Hours

22⁹⁹



SKU 972274
SAS866192 (M)
SKU 972275
SAS866193 (L)

Ear Plugs

Foam Ear Plugs (Box of 200)

SKU 526953
SAS6100

29⁹⁹

- Noise Reduction Rating: 30



Eye Wash Stations

Bottle Eye Wash Station*

SKU 094904
SAS5132

49⁹⁹

- Includes (2) 16 Oz. Eye Irrigate Solution Bottles



*Please Verify with OSHA or with a Certified Safety Professional That This Meets OSHA Requirements

16 Oz. Eye Wash Irrigate Refill

SKU 977588
SAS5130

24⁹⁹

- For Use with Eye Wash Station SAS5132

Emergency Eyewash Station - Wall Mount Gravity Fed

SKU 912344
SAS5134-00

204⁹⁹

- Compliance - ANSI Z358.1-2014
- One-hand, Single Motion Activation
- Gravity Fed, No Plumbing Required
- Portable Unit Measures 20.15" X 16.5" X 9.5"
- Includes: Mounting Bracket, Inspection Tag, Tamper Resistant Tie and Preservative
- Change Water Every 90 Days



Eyewash Solution 4.0 Oz.

SKU OUTSIDE BUY/EPO
SAS5136-01

6⁹⁹

- For Use with Eyewash Station #SAS5134-00

Available via Outside Buy/EPO, Call 1-877-298-6651 for Ordering Instructions

Do you have all the parts to finish the job?
Body Fastener Kits —

All kits are make-specific, carry OE style parts, include interior, exterior, and under hood fasteners.

GM Body Retainer Kit

Part #999175 Autozone Sku #557944
18 SKUs, 180 pcs.

49⁹⁹

Part No.	Description	Part No.	Description
450930B	Trim Panel Retainer	454760B	Trim Panel Retainer
451150B	Door Panel Retainer	454780B	Trim Panel Retainer
452630B	Rivet Style Retainer	454900B	Bumper Shield Retainer
454640B	Trim Panel Retainer	454910B	Trim Panel Retainer
454660B	Door Trim Panel Retainer	456900B	Headliner Retainer
454740B	Door Trim Panel Retainer	457030B	Trim Panel Retainer
454670B	Trim Panel Retainer	458110B	Trim Panel Retainer
454720B	Hood Insulation Retainer	458350B	Rear Hood Seal Retainer
454750B	Trim Panel Retainer	465030B	Trim Panel Retainer

Ford Body Retainer Kit

Part #999176 Autozone Sku #557945
24 SKUs, 240 pcs.

49⁹⁹

Part No.	Description	Part No.	Description
454620B	Push Style Retainer	465020B	Trim Panel Retainer
454640B	Panel Trim Retainer	465070B	Trim Panel Retainer
454670B	Trim Panel Retainer	465030B	Trim Panel Retainer
455140B	Push Style Retainer	465040B	Bumper Fascia Retainer
455150B	Trim Panel Retainer	465050B	Push Style Retainer
455200B	Door Panel Retainer	465080B	Trim Panel Retainer
454910B	Door Panel Retainer	465220B	Push Style Retainer
458110B	Panel Trim Retainer	465260B	Push Style Retainer
464150B	Trim Panel Retainer	479550B	Push Style Retainer
464340B	Trim Panel Retainer	479580B	Push Style Retainer
464800B	Bumper Fascia Retainer	479700B	Push Style Retainer
465010B	Trim Panel Retainer	479720B	Door Panel Retainer

Chrysler Body Retainer Kit

Part #999177 Autozone Sku #557946
24 SKUs, 240 pcs.

49⁹⁹

Part No.	Description	Part No.	Description
454910B	Door Trim Panel Retainer	465220B	Push-Type Retainer
454940B	Push-Type Retainer	465340B	Push In Retainer
455160B	Push-Type Retainer	465350B	Trim Panel Retainer
464850B	Trim Panel Retainer	465380B	Fascia Retainer
458100B	Fascia Retainer	465520B	Push Style Retainer
458220B	Trim Panel Retainer	464890B	Push-Type Retainer
464860B	Push Style Retainer	459840B	Push-Type Retainer
464100B	Trim Panel Retainer	461010B	Push-Type Retainer
464340B	Trim Panel Retainer	465170B	Weatherstrip Retainer
464820B	Push In Rivet 1/4"	465180B	Trim Panel Retainer
464830B	Push Style Retainer	479550B	Trim Panel Retainer
464840B	Push Style Retainer	479580B	Push Style Retainer

Honda Body Retainer Kit

Part #999179 Autozone Sku #557948
12 SKUs, 120 pcs.

27⁹⁹

Part No.	Description	Part No.	Description
455120B	Retainer	465320B	Trunk Molding Retainer
455130B	Weatherstrip Retainer	465330B	Push Style Retainer
459880B	Retainer	465340B	Push Style Retainer
459890B	Push Style Retainer	459860B	Trim Panel Retainer
465300B	Front Bumper Fascia Retainer	455170B	Trim Panel Retainer
465310B	Front Bumper Fascia Retainer	455180B	Push Style Retainer

Nissan Body Retainer Kit

Part #999182 Autozone Sku #557949
10 SKUs, 100 pcs.

27⁹⁹

Part No.	Description	Part No.	Description
454700B	Retainer	464170B	Trim Retainer
455110B	Bumper Fascia Retainer	465340B	Push Style Retainer
455400B	Push Style Retainer	465380B	Push Style Retainer
458230B	Push Style Retainer	465510B	Push Style Retainer
458240B	Push Style Retainer	458250B	Door Retainer

Toyota Body Retainer Kit

Part #999183 Autozone Sku #557950
12 SKUs, 120 pcs.

27⁹⁹

Part No.	Description	Part No.	Description
454700B	Trim Retainer	465510B	Molding Retainer
455400B	Push Style Retainer	465520B	Push Style Retainer
459850B	Panel Retainer	465530B	Push Style Retainer
459870B	Push Style Retainer	465540B	Cowl Panel Retainer
464170B	Door Trim Retainer	465550B	Push Style Retainer
465500B	Screw Grommet Head	465560B	Push Style Retainer

Value Pack Assortments

Get the best selling sizes in small packs

Part No.	AutoZone SKU #	Description	Pieces	Retail
020-430	557294	Cotter Pins	110	5.99
020-432	557940	Clamps	38	7.99
020-433	558394	Metric O-Rings	177	7.99
020-434	558396	Standard O-Rings	150	7.99
020-435	558467	Rivets	80	7.99
020-437	557941	Maintenance Hardware	102	7.99

Need a? Parts, a division of The Hillman Group Inc.

HILLMAN™

GLOVES

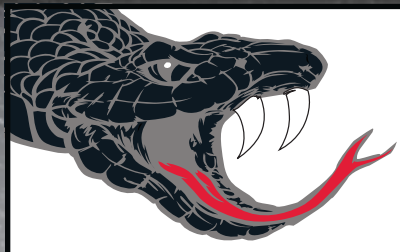

OEM TOOLS™

ViperFlex Powder-Free Nitrile Gloves

Provide increased protection and are more resistant to puncture. These 5 mil, powder-free gloves are the solution to bulky gloves, offering superior dexterity without compromising durability.

- Premium Latex-Free Gloves Provide Superior Protection Compared to Traditional Latex Gloves
- Powder-Free, Single-Use Disposable Gloves
- Ambidextrous Design to Fit Either Hand Comfortably
- Textured Palm and Fingertips for Added Grip
- 5 mil Thickness

100 Gloves 1 Box of 100 Each, \$19.99 Per Box

SKU 806533 24996S	(S)	19⁹⁹ Per Box
SKU 806575 24996M	(M)	
SKU 806492 24996L	(L)	
SKU 806496 24996XL	(XL)	
SKU 806499 24996XXL	(XXL)	



Gloves Not Included

Magnetic Glove Dispenser

SKU 765562
24945 **24⁹⁹**

- Attaches to Any Ferrous Surface for Convenient Glove Storage
- Self-Adjusting Spring Sides Hold Various Box Sizes
- (4) Powerful Magnets Provide 8 Lbs. Load Capacity



Nitrile Disposable Gloves

Powder-Free, Textured Grip, 4.5 mil

Professional Black Nitrile Gloves, M
2 Boxes of 100
SKU 504166 SAS66542PK2 **16⁹⁹** REG. \$19.99 **SAVE \$3**

Professional Black Nitrile Gloves, M
10 Boxes of 100
SKU 504168 SAS66542CS **72⁹⁹** REG. \$89.99 **SAVE \$17**

Professional Black Nitrile Gloves, XL
10 Boxes of 100
SKU 504172 SAS66544CS **72⁹⁹** REG. \$89.99 **SAVE \$17**

Professional Black Nitrile Gloves, L
2 Boxes of 100
SKU 504171 SAS66543PK2 **16⁹⁹** REG. \$19.99 **SAVE \$3**

Professional Black Nitrile Gloves, L
10 Boxes of 100
SKU 504169 SAS66543CS **72⁹⁹** REG. \$89.99 **SAVE \$17**

Professional Black Nitrile Gloves, XL
2 Boxes of 100
SKU 504170 SAS66544PK2 **16⁹⁹** REG. \$19.99 **SAVE \$3**



Offer Good Through March 31, 2019 While Supplies Last

Custom Leather Gloves



Backcountry™ - Mossy Oak® Camo Hi-Dexterity Gloves- Large

SKU 222814 CLCM125L **24⁹⁹**

Backcountry™ - Mossy Oak® Camo Hi-Dexterity Gloves- Medium

SKU 222812 CLCM125M **24⁹⁹**

Backcountry™ - Mossy Oak® Camo Hi-Dexterity Gloves- X Large

SKU 222816 CLCM125X **24⁹⁹**

Timberline™ - Mossy Oak® Camo, Lined Hi-Dexterity Gloves- Large

SKU 222813 CLCML125L **29⁹⁹**

3M® Thinsulate™ lining provides warmth without bulk

Timberline™ - Mossy Oak® Camo, Lined Hi-Dexterity Gloves X Large

SKU 222815 CLCML125X **29⁹⁹**



- FASTFIT™ MFF-05
- TOUCHSCREEN CAPABLE
- MACHINE WASHABLE



SKU	PART#	DESCRIPTION	PRICE
244340*	MFF-05-008	FASTFIT® BLACK SM	14 ⁹⁹
240886	MFF-05-009	FASTFIT® BLACK MD	14 ⁹⁹
240887	MFF-05-010	FASTFIT® BLACK LG	14 ⁹⁹
240888	MFF-05-011	FASTFIT® BLACK XL	14 ⁹⁹
244341*	MFF-05-012	FASTFIT® BLACK XXL	14 ⁹⁹

- Comfortable stretch-elastic cuffs
- High-dexterity 0.6mm synthetic leather
- Touchscreen capable

*Special Order Only

STOCK STOCKED



- THE ORIGINAL™ MG-05
- TOUCHSCREEN CAPABLE
- MACHINE WASHABLE



SKU	PART#	DESCRIPTION	PRICE
244356	MG-05-008	THE ORIGINAL® BLACK SM	19 ⁹⁹
240898	MG-05-009	THE ORIGINAL® BLACK MD	19 ⁹⁹
240899	MG-05-010	THE ORIGINAL® BLACK LG	19 ⁹⁹
240900	MG-05-011	THE ORIGINAL® BLACK XL	19 ⁹⁹
244357*	MG-05-012	THE ORIGINAL® BLACK XXL	19 ⁹⁹

- Flexible Thermoplastic Rubber (TPR) closure
- Seamless synthetic leather palm
- Touchscreen capable

*Special Order Only

STOCK STOCKED

THE TOOL THAT FITS LIKE A GLOVE

ACCELERATE your business

GLOVES FOR WORKING FASTER AND SAFER



Microflex® CHEM3™: The thinnest chemical resistant disposable glove

(6 Gloves Per Pack)

- Lasts up to 3X longer in acetone and up to 5X longer against lacquer thinner compared to competitive gloves
- Confident chemical protection without compromising dexterity and tactile

Style #: 93-260RP

SIZE	SKU	PART#
L	936896	MF93260RP090
XL	936897	MF93260RP100

3⁹⁹ each

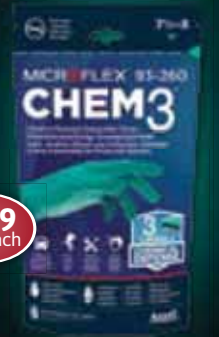

Microflex® Diamond Grip® (100 Gloves Per Box)



- Unique design prevents ripping and tearing
- Enhanced, textured fingertips for added protection and function
- Ideal for rugged tasks in mid to heavy-duty environments

SIZE	SKU	PART#
M	497065	MF-300-M
L	497064	MF-300-L
XL	497066	MF-300-XL

18⁹⁹ each

Microflex® Dura Flock® (50 Gloves Per Box)



- Flock-lined for sweat absorption
- 25% thicker than standard disposable gloves
- Longer cuff for increased protection
- Fully textured surface for a great grip

SIZE	SKU	PART#
L	429676	DFK-608-L
XL	429678	DFK-608-XL

19⁹⁹ each

MICROFLEX®

Ansell

APPAREL & UNIFORMS

877-AZTool1
877-298-6651
Hablamos Español
AZtool1.com

Beanie

Hi-Viz Knit Beanie

- One Size Fits All
- Comfortable and Warm
- ANSI/ISEA 107 Compliant Reflective Knit Stripe



Orange
 SKU 687972
 SAS692-1711
19⁹⁹



Yellow
 SKU 687971
 SAS690-1711
19⁹⁹

Performance Technician Shirt

Long Sleeve Shirt

Sizes M-3XL
 SKU 348420
 VFISP14AC **34⁹⁹**

Short Sleeve Shirt

Sizes M-3XL
 SKU 348419
 VFISP24AC **29⁹⁹**



Name Tag and Shop Name Are Extra, Call for Pricing

The official work shirt provider of PowerNation TV



Step It Up with the OEMTOOLS™ Adjustable Tire Step

The **OEMTOOLS™ Adjustable Tire Step** wraps over the tire, providing a safe, no-slip step. This Tire Step is designed for SUVs, Motor Homes and Light-Duty Trucks, making it perfect for accessing roof racks, windshields, under-hood and more.

Adjustable Tire Step

- SKU 818571 **30⁹⁹**
 24913
- Fits Both Front and Rear 9 In. to 13 In. Wide Tires
 - Powder Coat Finish
 - Easy to Adjust
 - Weight Capacity: 300 Lbs.



Jackets

Name Tag and Shop Name are Extra, Call for Pricing at 877-AZTOOL1

Crew Jacket

SKU 222840 **54⁹⁹**
 VFJIT38

- Rib Knit Collar, Cuffs and Waistband
- Lined for Added Warmth and Durability
- Mid-length
- Left Sleeve Utility Pocket
- Sizes: S-6XL
- Colors: Black, Charcoal, Navy



Performance Panel Jacket

SKU 222839 **54⁹⁹**
 VFJIT50

- Ready for Any Job Your Shop Throws its Way
- Left Sleeve Utility Pocket
- Hip-length
- Lined for Added Warmth and Durability
- Sizes: S-6XL
- Colors: Black, Charcoal, Navy

Hi Viz Jacket

SKU 543352 **69⁹⁹**
 VFJIT50EN

- Hip-length
- Lined with Black Quilted Lining
- 2 ½" Enhanced Visibility Trim Applied Across Chest, Down Arms from Shoulder to Sleeve Hem, and Two Horizontal Strips Across the Back
- This Product Does Not Comply with ANSI 107-2004 or 107-2010
- Sizes: S, M, L, XL



Nitrile Palm Knit Gloves

Nitrile Palm Knit Glove 1 Dozen L

SKU 250887 **39⁹⁹**
 SAS6401909

Nitrile Palm Knit Glove 1 Dozen XL

SKU 250888 **39⁹⁹**
 SAS6401910

Nitrile Palm Knit Glove 1 Dozen XXL

SKU 250890 **39⁹⁹**
 SAS6401911



Work Shirts



Name Tag and Shop Name Are Extra, Call for Pricing

Crew Shirt

- Designed for Auto Industry
- Ripstop Fabric
- Concealed Buttons Protects Paint Jobs
- Resists Stains
- Sleeve Utility Pocket
- Lightweight and Breathable

Long Sleeve Shirt

Sizes M-3XL
 SKU 222833 **39⁹⁹**
 VFISY10

Short Sleeve Shirt

Sizes M-3XL
 SKU 222832 **39⁹⁹**
 VFISY20

Hand Cleaner

4 Liter Refill Bottle

SKU 972772 **34⁹⁹**
 24291



Starter Kit with **BONUS** Dispenser

SKU 972773 **39⁹⁹**
 24292

- Kit Includes Wall-Mount Dispenser and 4 Liters of Cherry Fragrance Cleaner



No Scratch Belt

No-Scratch Leather Belt

29⁹⁹

Belt Buckles and Garages Don't Mix. This Leather Belt Features a No-Scratch Front So You Can Get Up Close and Personal with the Task at Hand

- Sizes S-XL
- Concealed Metal Buckle Protects Any Paint Job



DID YOU KNOW?

AutoZone® carries a full line of truck accessories and parts

Contact Your AutoZone Commercial Sales Manager for Details

Part #	SKU	Size
VFIAB12BKBS	222845	Small (28" - 32")
VFIAB12BKBM	695576	Medium (34" - 38")
VFIAB12BKBL	695577	Large (40" - 44")
VFIAB12BKXLL	695578	X-Large (46" - 50")

PROMOS While Supplies Last

Offers Good Through March 31, 2019

Fluid Management

25 Gallon Fuel Chief Steel Gas Caddy

SKU 360585
DOWFC25GC **599⁹⁹**

- 25-Gallon Tank is Constructed of 14" Gauge Steel for Use with Unleaded Gasoline, Kerosene, Ethanol E85, Diesel, and Bio-Diesel Fuels



BONUS VALUE: \$189.99



Fuel Tank Adapter
SKU 222503 | DOWJDI-FTA7
With Purchase of:
25 Gallon Fuel Chief Steel Gas Caddy
SKU 360585 | DOWFC25GC
Offer Good Through March 31, 2019
While Supplies Last

17 Gallon Low-Profile Portable Oil Drain

SKU 360666
DOWJDILP4 **459⁹⁹**

- 17-Gallon Evacuation Capacity
- 10" Ground Clearance
- Expanded Metal Shield Reduces Splash
- Emptied by Gravity Drain, Evacuation Pump or Air Evacuation



BONUS VALUE: \$199.99

Shop Air Evacuation Kit

SKU 360667 | DOWJDIEK
With Purchase of:
17 Gallon Low-Profile Oil Drain
SKU 360666 | DOWJDILP4
Offer Good Through March 31, 2019 - While Supplies Last

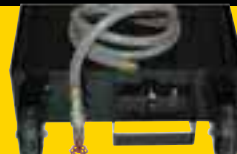

12V Powerluber

SKU 219686
LIN1242

199⁹⁹

- 6,000 PSI
- High Capacity Ni-Cad 12 Volt Battery
- 30" Flex Hose, Spring Guard and Coupler
- 1 Hour Smart Charger



BONUS VALUE: \$89.99



12V Battery
SKU 219699 | LIN1201
With Purchase of:
12V Powerluber
SKU 219686 | LIN1242
VDP ORDERS ONLY

Offer Good Through March 31, 2019 - While Supplies Last

25 Gallon Used Fluid Combo Drain/Evacuator

SKU 543345
LIN3639
519⁹⁹ REG. \$599.99

- Powerful Compressed Air Operated Venturi Vacuum Quickly Draws Fluids from Reservoirs
- Includes Mercedes-Benz, BMW and VW Dipstick Tube Adapters and (6) Evacuation Wands of Varying Flexibility, Diameter and Length
- Pressurized Self-Evacuation Feature Requires Only Shop Air and a Tire Chuck to Discharge Fluids



SAVE \$80

Oil and Lube

9 Gallon Upright Portable Oil Drain

SKU 908386
87032

69⁹⁹

- Funnel Diameter: 17"
- Features Built-in Drain Valve and Evacuation Spout

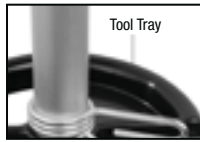

18 Gallon Upright Portable Oil Drain

SKU 908388
87031

99⁹⁹

- Funnel Diameter: 18"
- Features Built-in Drain Valve and Evacuation Spout



OEM TOOLS

BONUS VALUE: \$34.99

Drain Plug Socket Set

SKU 818568 | 25374

With Purchase of:
9 Gallon Upright Portable Oil Drain
SKU 908386 | 87032

OR **18 Gallon Upright Portable Oil Drain**
SKU 908388 | 87031

Offer Good Through March 31, 2019
While Supplies Last

Paint and Body

Fender Roller

SKU 912346
25895

79⁹⁹ REG. 89.99

- Great for Use on Lowered Vehicles or Vehicles with Larger Tires
- For Passenger Vehicles and Light Trucks with 4- and 5-Lug Bolt Patterns (Up to 4.75"/120 mm)
- Adjustable Roller Range (Measured from Center of Hub): 14" to 22.5"



SAVE \$10

Jacks and Hydraulics

Engine Leveler

SKU 544802
24831

39⁹⁹ REG. \$49.99

- Great for Use with Engine Hoist or Engine Crane
- Makes Engine Handling and Positioning Easier
- Rated Capacity: 1,600 Lbs.



SAVE \$10

Portable 11 Ton Air Hydraulic Jack

SKU 765557
ACHB25-2

1,699⁹⁹ REG. \$1,899.99

- Minimum Height: 6.38"; Weight: 60 Lbs.
- Hard Chromium Plated Piston Rod for Long Life
- Built-in Safety Overload Valve
- Hand-Operated Dead-Man's Control
- 2 Extensions (1.97"/3.94") for Max. Height of 18.5"



SAVE \$200



800 Lbs. Low Profile Transmission Jack

SKU 544789
24843

329⁹⁹ REG. 349.99

- Lift Range: 8-1/4" to 30-1/2"
- Fully Adjustable Saddle Adapts to Most Transmission Pans
- Swivel Saddle Adjusts Both Directions
- 4 Swivel Ball Bearing Casters for Ease of Mobility



SAVE \$20

Hand Tools

3 Piece Seam Splitter Set

SKU 265129
25337

34⁹⁹ REG. 39.99

- Includes Straight, 30° Offset and 90° Angle Seam Splitters
- Tough Chrome Vanadium Steel
- Go Through Shafts
- Shock Dampening Grip Provides Comfort



SAVE \$5

4 Piece Automotive Pliers Set

SKU 081317
KNP9K008094US

134⁹⁹ REG. \$154.99

- Includes: 10" Cobra Pliers, 10" Diagonal Cutter, 8" Long Nose Pliers and 8" Combination Pliers



SAVE \$20

Available via Outside Buy/EPO, Call 1-877-298-6651 for Ordering Instructions

Gloves

Powder-Free, Textured Grip, 4.5 mil

Professional Black Nitrile Gloves, M 2 Boxes of 100

SKU 504166
SAS66542PK2

16⁹⁹ REG. \$19.99

SAVE \$3

Professional Black Nitrile Gloves, M 10 Boxes of 100

SKU 504168
SAS66542CS

72⁹⁹ REG. \$89.99

SAVE \$17

Professional Black Nitrile Gloves, L 2 Boxes of 100

SKU 504171
SAS66543PK2

16⁹⁹ REG. \$19.99

SAVE \$3

Professional Black Nitrile Gloves, L 10 Boxes of 100

SKU 504169
SAS66543CS

72⁹⁹ REG. \$89.99

SAVE \$17

Professional Black Nitrile Gloves, XL 2 Boxes of 100

SKU 504170
SAS66544PK2

16⁹⁹ REG. \$19.99

SAVE \$3

Professional Black Nitrile Gloves, XL 10 Boxes of 100

SKU 504172
SAS66544CS

72⁹⁹ REG. \$89.99

SAVE \$17



Torx Bit Set - 9 Piece

SKU 081784
LIS26550

22⁹⁹ REG. \$39.99

- Sizes: T10, T15, T20, T25, T27, T30, T40, T45 and T50

SAVE \$17



10 Piece Super Torx Bit Set

SKU 081319
LIS37600

24⁹⁹ REG. \$39.99

- Sizes: T10, T15, T20, T25, T27, T30, T40, T45 and T50

SAVE \$15

Torx Socket Set

SKU 081786
LIS26750

16⁹⁹ REG. \$29.99

- Bit Sizes E-6 Through E-16
- Made of Heat-Treated Alloy Steel for Durability
- Comes in a Vinyl Holder for Easy Storage

SAVE \$13

12 Point Triple Square Bit Set

SKU 081790
LIS60750

14⁹⁹ REG. \$24.99

SAVE \$10

CLEARANCE While Supplies Last

OEM TOOLS

Li-ion Power Bank and Car Jump Starter 8000 mAh
SKU 568483
24379

**NOW \$89⁹⁹
WAS \$99⁹⁹**

- Jump Starts A Vehicle (V6 Engine and Smaller) Up to 20 Times Depending on Level of Charge, Battery Condition, etc.
- Rechargeable 8,000 mAh Lithium-ion Battery
- Current: 200 Amps (Starting), 400 Amps (Peak)
- Output Ports: 5V-2A USB, 12V-10A
- Charges a Smartphone in About One Hour
- Charges USB Powered Devices 2 Times Faster Than a Wall Outlet
- Recharges Up to 1,000 Times (Low Self-Discharge Rate)
- Input Port: 14V-1A



GreatLite

E66 CREE LED Flashlight
SKU 347204
EXPE66

**NOW \$29⁹⁹
WAS \$49⁹⁹**

- Dimensions: 10.2" (L) x 1.7" (D) x 2.2" (Head)
- Beam Distance: 300m
- Impact Resistance: 1.5m
- Water Resistant: IPX-4
- Comes with (2) D Duracell® Batteries

500 LUMENS | MAX RUN TIME 3hrs



GreatLite

E67 CREE LED Tactical Flashlight Only
SKU 347205
EXPE67

**NOW \$24⁹⁹
WAS \$44⁹⁹**

- Beam Distance: 200m
- Impact Resistance: 1.5m
- Waterproof: IPX-8
- Comes with (2) CR123A Batteries (Rechargeable Batteries and Charger Sold Separately)

400 LUMENS | MAX RUN TIME 3hrs



GreatLite

E81 Cree LED Tactical Flashlight Only
SKU 347207
EXPE81

**NOW \$29⁹⁹
WAS \$49⁹⁹**

- Beam Distance: 200m
- Impact Resistance: 1.5m
- Waterproof: IPX-8
- Comes with (2) CR123A Batteries (Rechargeable Batteries and Charger Sold Separately)

500 LUMENS | MAX RUN TIME 3hrs



GreatLite

E84 CREE LED Professional Stubby Pocket Flashlight
SKU 568464
EXPE84

**NOW \$19⁹⁹
WAS \$34⁹⁹**

- Dimensions: 3.5" (L) x 0.9" (D) x 0.9" (Head)
- Beam Distance: 30m
- Impact Resistance: 1.5m
- Waterproof: IPX-8
- Comes with (1) CR123A Battery

200 LUMENS | MAX RUN TIME 1.5hrs



GreatLite

E31 Cree LED Professional Focus Flashlight
SKU 568456
EXPE31

**NOW \$14⁹⁹
WAS \$24⁹⁹**

- Dimensions: 5.28" (L) x 1.1" (D) x 1.5" (Head)
- Beam Distance: 200m
- Impact Resistance: 1.5m
- Water Resistant: IPX-4
- Comes with 3 AAA Duracell® Batteries

230 LUMENS | MAX RUN TIME 4hrs



GreatLite

E32 Cree LED Professional Focus Flashlights
SKU 568457
EXPE32

**NOW \$14⁹⁹
WAS \$22⁹⁹**

- Dimensions: 6.36" (L) x 0.73" (D) x 1.04" (Head)
- Beam Distance: 30m
- Impact Resistance: 1.5m
- Water Resistant: IPX-4
- Comes with 2 AA Duracell® Batteries

120 LUMENS | MAX RUN TIME 2hrs



GreatLite

E33 Cree LED Professional Focus Flashlights
SKU 568458
EXPE33

**NOW \$14⁹⁹
WAS \$21⁹⁹**

- Dimensions: 4.4" (L) x 0.7" (D) x 1.0" (Head)
- Beam Distance: 30m
- Impact Resistance: 1.5m
- Water Resistant: IPX-4
- Comes with 1 AA Duracell® Battery

80 LUMENS | MAX RUN TIME 1.5hrs



GreatLite

E51 CREE LED Multi-Function Headlight
SKU 347231
EXPE51

**NOW \$9⁹⁹
WAS \$15⁹⁹**

- Dimensions: 2.36" (L) x 2.0" (D) x 1.57" (H)
- Beam Distance: 35m
- Impact Resistance: 1.5m
- Water Resistant: IPX-6
- Comes with 3 AAA Duracell® Batteries
- 1 White Light CREE XP-LED Bulb and 2 Red LED Bulbs

160 LUMENS | MAX RUN TIME 3hrs



GreatLite

E65 Cree LED Tactical Flashlight
SKU 347203
EXPE65

**NOW \$19⁹⁹
WAS \$34⁹⁹**

- Dimensions: 6.85" (L) x 1.36" (D) x 1.71" (Head)
- Beam Distance: 300m
- Impact Resistance: 1.5m
- Waterproof: IPX-8
- Comes with (2) C Duracell® Batteries

400 LUMENS | MAX RUN TIME 2hrs



GreatLite

E82 Cree LED Pocket Flashlight
SKU 568462
EXPE82

**NOW \$14⁹⁹
WAS \$24⁹⁹**

- Dimensions: 4.2" (L) x 0.9" (D) x 0.9" (Head)
- Beam Distance: 30m
- Impact Resistance: 1.5m
- Waterproof: IPX-8
- Comes with 1 AA Duracell® Battery

100 LUMENS | MAX RUN TIME 1.2hrs



GreatLite

E86 Headlight and Flashlight
SKU 568465
EXPE86

**NOW \$9⁹⁹
WAS \$19⁹⁹**

- Dimensions: 3.3" (L) x 0.7" (D) x 0.9" (Head)
- Beam Distance: 15m
- Impact Resistance: 1.5m
- Water Resistant: IPX-6
- Comes with 1 AA Duracell® Battery
- Includes Headband, 2 Headlight Cradles: Black and Glow-in-the-Dark

100 LUMENS | MAX RUN TIME 1hr



GreatLite

E36 CREE Rechargeable Flashlight Only
SKU 568460
EXPE36

**NOW \$39⁹⁹
WAS \$44⁹⁹**

- Beam Distance: 300m
- Impact Resistant Up to 1.5m
- IPX-6 Water Resistant
- Flashlight Only
- Comes with (2) CR123A Batteries, (Rechargeable Batteries and Charger Sold Separately)

800 LUMENS | MAX RUN TIME 2hrs



GreatLite

CREE LED Pen Light
SKU 592184
32835 (Black)

**NOW \$14⁹⁹
WAS \$19⁹⁹**

- Comes with 2 AAA Panasonic® Batteries and Tactical Clip
- 3 Modes: Low (50 Lumens), High (150 Lumens) and Strobe
- Battery Run Time: 6 Hours (Low), 3 Hours (High)
- 80 Meter Beam Distance
- Impact and Water Resistant
- Dimensions: 5.7" (L) x 0.6" (D)
- Weight: 1.6 Oz.

150 LUMENS | MAX RUN TIME 3hrs

(Blue) SKU 592185 32836
(Green) SKU 592186 32837
(Red) SKU 592188 32838
(Silver) SKU 592183 32839



GreatLite

3.7 Volt Li-ion Battery
SKU 535222
EXPE04

**NOW \$9⁹⁹
WAS \$17⁹⁹**

Use with Charger: EXPE02

For Use with:

24648
32827
24607



AZtool1.com

877-AZTool1 (877-298-6651) Hablamos Español

Creepers Seats: For All Day Comfort and Mobility

OEM TOOLS™

Workshop Creeper Seat with 2 Drawers

- Vinyl Foam Padded Seat for Maximum Comfort
- 2 Sliding Drawers to Store Parts
- Under Seat Storage for Tools, Parts & Accessories
- Can Holder for 3 Cans
- Smooth Rolling Swivel Castor Wheels
- Weight Capacity: 280 Lbs.



Can Holder for 3 Cans



2 Inch Smooth Rolling Castor Wheels

White SKU 542429 24995 99⁹⁹	Yellow SKU 542931 24999 99⁹⁹	Red SKU 542826 24998 99⁹⁹
Blue SKU 542531 24996 99⁹⁹	Orange SKU 542617 24997 99⁹⁹	Black SKU 542385 24994 99⁹⁹
Green SKU 542354 24993 99⁹⁹		

Duralast

10 Piece Hex and Star Bit Set

SKU 914078 **6⁹⁹** Prev. \$24.99
70-062

- Chrome Vanadium Bit Holders with S2 Bits
- Fits Most Caliper Bolts
- Includes: T40, T45, T47, T50, T55, 7 mm, 8 mm, 10 mm, 1/4" and 3/8"



SAVE \$18

Offer Good Through March 31, 2019 While Supplies Last

9 Piece Star Bit Set

SKU 914171 **5⁹⁹** Prev. \$19.99
70-054

- Chrome Vanadium Steel
- 1/4 Drive: T10, T15, T20, T27, T30
- 3/8 Drive: T40, T45, T47



Duralast

SAVE \$15

Offer Good Through March 31, 2019 While Supplies Last

3 Piece Locking Extension Set

SKU 595333 **7⁹⁹** Prev. \$14.99
70-123

- Set Includes: 1/4 Drive x 6", 3/8 Drive x 10" and 1/2 Drive x 5"
- Chrome Vanadium Steel
- Protective Ring for Added Safety and Push Button Quick Release



SAVE \$7

17 Piece Air Tool Accessory Kit

SKU 800341 **8⁹⁹** Prev. \$17.99
80-326

- 1/4" NPT (F)
- Kit Includes: Safety Lever Blow Gun, Blow Gun Inflators, Pressure Gauge, Dual Tire Chunk, Coupler, 2 Male Connectors, Female Connector, 2 Female Couplers, and 4 Male Couplers
- Industrial Interchange

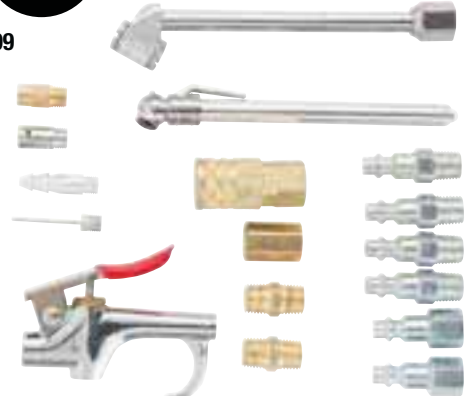

Duralast

SAVE \$9

Offer Good Through March 31, 2019 While Supplies Last

BONUS VALUE: \$12.99 50' PVC Air Hose

50' PVC Air Hose

SKU 738335 **80-336**
• 3/8" x 50'
• 1/4" NPT Male Ends

- PVC Construction
- Protection Hose Sleeves
- 300 PSI Working Pressure
- 0°F - 130°F Working Temperature

With Purchase of:
the **Duralast®** products below



Offer Good Through March 31, 2019 While Supplies Last

SKU 688265 | Part# 80-360 or
SKU 688261 | Part# 80-361 or
SKU 738285 | Part# 80-375 or
SKU 738486 | Part# 80-370 or
SKU 738488 | Part# 80-372 or
SKU 688273 | Part# 80-366

1/2" Drive Impact Wrench

SKU 688265 **29⁹⁹** Prev. \$59.99
80-360

- Driver Size: 1/2"
- Clutch Type: Single Hammer
- Air Consumption: 4 CFM
- Free Speed: 7,500 RPM
- Maximum Torque: 250 Ft/Lbs.
- Weight: 4 Lbs.
- Recommended Air Pressure: 90 PSI
- Air Inlet (NPT): 1/4"



SAVE \$30

1/2" Drive Impact Wrench

SKU 688261 **59⁹⁹** Prev. \$99.99
80-361

- Driver Size: 1/2"
- Clutch Type: Twin Hammer
- Air Consumption: 4 CFM
- Free Speed: 7,500 RPM
- Maximum Torque: 500 Ft/Lbs.
- Weight: 4.6 Lbs.
- Recommended Air Pressure: 90 PSI
- Air Inlet (NPT): 1/4"



SAVE \$40

17 Piece Air Tool Kit

SKU 738285 **59⁹⁹** Prev. \$99.99
80-375

- Kit Includes: (1) 1/2" Impact Wrench, (10) Impact Sockets: 3/4", 11/16", 5/8", 9/16", 1/2" and 17 mm, 14 mm, 13 mm, 12 mm, 11 mm
- (1) 3/8" Drive Air Ratchet Wrench, (1) Air Oil Tool, (1) Oiler, (1) Air Nipple
- 1/2" Drive Impact Wrench: 4 CFM; Maximum Torque: 250 Ft/Lbs.
- 3/8" Drive Air Ratchet: 4 CFM; Maximum Torque: 59 Ft/Lbs.
- Air Inlet (NPT): 1/4" (for Both Impact and Ratchet Wrench)



SAVE \$40

6" Dual Action Air Sander

SKU 738486 **27⁹⁹** Prev. \$49.99
80-370

- Air Consumption: 4 CFM
- Free Speed: 10,000 RPM
- Weight: 4 Lbs.
- Recommended Air Pressure: 90 PSI
- Air Inlet (NPT): 1/4"
- Includes: (1) 6" Dual Action Air Sander, (1) Quick Connect Nipple and (1) 6" Backing Pad



SAVE \$22

6" Orbital Air Sander

SKU 738488 **43⁹⁹** Prev. \$59.99
80-372

- Air Consumption: 3 CFM
- Free Speed: 10,500 RPM
- Weight: 1.91 Lbs.
- Recommended Air Pressure: 90 PSI
- Air Inlet (NPT): 1/4"
- Includes: (1) 6" Dual Action Air Sander, (1) Quick Connect Nipple, (1) 6" Backing Pad and (1) Wrench



SAVE \$16

3" Air Cut-Off Tool

SKU 688273 **15⁹⁹** Prev. \$19.99
80-366

- Wheel Diameter: 3"
- Air Consumption: 4 CFM
- Free Speed: 20,000 RPM
- Weight: 1.67 Lbs.
- Recommended Air Pressure: 90 PSI
- Air Inlet (NPT): 1/4"
- Includes: (1) 3" Air Cut-Off Tool, (1) Quick Connect Nipple, (1) Plastic Safe Guard, (3) Wrenches and (1) 3" Cutting Disc



SAVE \$4

Offers Good Through March 31, 2019 While Supplies Last

FOR FINANCING PROGRAMS SEE PAGE 2



Be Car Care Aware

Financing is provided by third parties who are not affiliates of AutoZone. All of the advertised loan programs, rates, terms and conditions are subject to change at any time without notice. An extra charge may be imposed at the end of the lease depending on the residual value of the leased goods. Free overnight shipping available to continental U.S. for qualifying VDP orders of 70 Lbs. or less. Free overnight shipping excludes: lift-gate fees, residential delivery, non-network carriers, and certain freight intensive items that are shipped FOB.

©2019 Great Neck Saw Manufacturing, Inc. Certain content provided by and the property of AutoZone, Inc. All rights reserved. AutoZone, AutoZone & Design, Loan A Tool, Duralast, Duralast Gold, Duralast Proven Tough and Duralast ProPower are registered marks of AutoZone IP LLC or one of its affiliates. All other marks are the property of their respective holders. iPhone® is a registered trademark of Apple Inc., Android® is a trademark of Google Inc., STP® is a registered trademark of the Armor All/STP Products Co., and Bluetooth® is a trademark of Bluetooth® SIG, Inc. Items requiring freight shipping cannot be delivered outside of the continental United States. For shipping cost to Alaska or Hawaii, please contact Commercial Sales Manager. Ad prices cannot be combined with any other offer. Offers may vary by market. Offers valid while quantities last. Items may not be available at all locations at all times. We reserve the right to limit quantities and to correct pricing errors. Some new items might not be available at the time of print deadline. Prices valid only during sales catalog effective dates. All photographic, clerical, typographical and printing errors are subject to correction. Images shown may not be actual product but represent products or sets which include product. We reserve the right to substitute a like item or an item of greater value on any promotional offer in this publication. Store stock items may be purchased at any local AutoZone store or through your AutoZone Commercial Sales Manager.

AZG0119 | SKU 996234 \$2.99



TOOL of the MONTH



1-877-AZTool1 Hablamos Español (1-877-298-6651)

SAVE \$20

NOCO
Since 1914

Offer Good January 1-31, 2019 - While Supplies Last

TOOL of the MONTH

January

SKU 851787 | GB70

Jump Starts Gas Engines Up to 8 Liters and Diesel Engines up to 6 Liters: Cars, Boats, Motorcycles, Trucks and More

- A Lithium Battery Jump Starter Rated at 2,000 Amps (15,700 Joules3S)
- Spark-Proof Connections and Reverse Polarity Protection
- Recharges USB Devices, Like Smartphones, Tablets and More
- Power 12V Devices Anywhere, Like Tire Inflators, Power Inverters and More
- 400 Lumen LED Flashlight with Multiple Modes, Including SOS
- Jump Starts Gas Engines Up to 8 Liters and Diesel Engines Up to 6 Liters
- Provides Up to 40 Jump Starts on a Single Charge

GB70 Boost Plus

199⁹⁹

Reg. \$219.99



See Page 42 for Details

SAVE \$30



Offer Good February 1-28, 2019 - While Supplies Last

TOOL of the MONTH

February

SKU 082937 | 25437

- Get the Tools You Need to Service Brake Calipers in Most Vehicles on the Road Today
- This All-in-One Set Includes an 18 Piece Disc Brake Caliper Tool Set, (2) Brake Bleeder Wrenches and a Heavy Duty Brake Caliper Brush

**Brake Caliper
Service Set**

44⁹⁹

Reg. \$74.99



SAVE \$10



Offer Good March 1-31, 2019 - While Supplies Last

TOOL of the MONTH

March

SKU 081788 | 22988

- Use with a Variety of Drive Tools: Locking Pliers, Wrench or Ratchet
- Aluminum Rails Ensure Easy-Access Storage
- Fits SAE and Metric Sizes: 5/16", 11/16", 3/4", 3/8", 1/2", 9/16", 5/8" (8 mm, 10 mm, 13 mm, 14 mm, 16 mm and 19 mm)

**10 Piece Spiral Type
Bolt Extractor Set**

39⁹⁹

Reg. \$49.99



Grips and Removes a Wide Range of Stubborn Fasteners



Bites into Rusted, Rounded and Painted Over Nuts and Bolts

See Page 73 for Details

Items must be on the same invoice to qualify for pricing. Not valid with any other offer. Offer valid while supplies last. Offer good for AutoZone® Commercial customers only. No rain checks. Discounts are subject to change without notice. We reserve the right to limit quantities. Allow 1-2 weeks for delivery. Ask your Commercial Sales Manager for details. ©2019 Great Neck Saw Manufacturing, Inc. All rights reserved. AutoZone, AutoZone & Design, Loan A Tool, Duralast, Duralast Gold and Duralast ProPower are registered marks of AutoZone IP LLC or one of its affiliates. All other marks are the property of their respective owners.

**SHOP
SUPPLY
of the
MONTH**



1-877-AZTool1 Hablamos Español (1-877-298-6651)



Offer Good January 1-31, 2019 - While Supplies Last

**SHOP
SUPPLY
of the
MONTH**

January

700 Lumen Rechargeable COB LED Slim Inspection Light

SKU 418752 | **24646**

- Unique Variable Dial Lets You Control Output (0-700 Lumens)
- Run Time: 10 Hours (at 50% Power), 2.5 Hours (at 100%)
- Removable Magnetic Base with 360° Swivel and Lock Feature
- Convenient Hook for Hanging
- USB Charging Port
- Lightweight: 6.6 Oz.
- Comes with (1) 18650 Rechargeable Lithium Battery

See Page 89 for Details



360° Swivel Base

29⁹⁹



USB Charging Port



SAVE \$15



Offer Good February 1-28, 2019 - While Supplies Last

**SHOP
SUPPLY
of the
MONTH**

February

Direct Fit Oil Funnel Set

54⁹⁹ Reg. \$69.99

SKU 824884 | **87039**

- Set Includes: Universal Oil Funnel, Chrysler (87019), Ford/Mazda (87020), GM (87021), Honda (87022), Toyota/Lexus (87024), Subaru Adapter (87023), Toyota/Lexus Adapter (87024), and 150° Extended Adapter (87027)
- Threaded to Fit a Range of Import and Domestic Vehicles, Older and Current Models
- Transparent Lower Chamber to Monitor Oil Flow
- Wide Passage for Rapid Refilling

See Page 50 for Details



SAVE \$7



Offers Good March 1-31, 2019 - While Supplies Last

**SHOP
SUPPLY
of the
MONTH**

March

Tire Repair and Emergency Tool Set

32⁹⁹ Reg. \$39.99

SKU 081337 | **26680**

- Easily Repair Punctured Tubeless Tires on Most Vehicles without Removing the Tire from the Rim
- Tire Repair Kit Includes: (30) 4" String Repair Plugs, Rasp Tool, Insert Needle Tool, (2) Hex Keys, Sealing Lubricant and Blow Mold Storage Case
- 4-in-1 Tire Gauge Features a Tire Gauge, Tire Deflator, Rescue Hammer and Seat-Belt Cutter
- Tire Gauge Measuring Ranges: 0-150PSI, 0-10BAR, 0-100KPA and 0-10Kg/cm²
- Backlit LCD Display and Lighted Nozzle for Use in Low-Light Settings

See Page 11 for Details



Items must be on the same invoice to qualify for pricing. Not valid with any other offer. Offer valid while supplies last. Offer good for AutoZone® Commercial customers only. No rain checks. Discounts are subject to change without notice. We reserve the right to limit quantities. Allow 1-2 weeks for delivery. Ask your Commercial Sales Manager for details. ©2019 Great Neck Saw Manufacturing, Inc. All rights reserved. AutoZone, AutoZone & Design, Loan A Tool, Duralast, Duralast Gold and Duralast ProPower are registered marks of AutoZone IP LLC or one of its affiliates. All other marks are the property of their respective owners.